

Description: LOW PROFILE MULTIBAND ANTENNA

Series: IceFin

PART NUMBER: ICEFINXXX



Features:

- Transparent clear visually appealing plastic radome
- Short, slim profile without sacrificing RF or mechanical performance
- Direct and NMO mount models
- IP67 Weatherproof



Applications:

- Models supporting :
 - Public Safety, LMR
 - Wi-Fi,
 - 3G/4G LTE,
 - ISM
 - DSRC
- Bus/Rail/Transit
- IoT – Vending, metering and other industrial applications
- Outdoor Vehicular

All dimensions are in mm / inches

Issue: 1743

In the effort to improve our products, we reserve the right to make changes judged to be necessary.

CONFIDENTIAL AND PROPRIETARY INFORMATION

This document contains confidential and proprietary information of Pulse Electronics, Inc. (Pulse) and is protected by copyright, trade secret and other state and federal laws. Its receipt or possession does not convey any rights to reproduce, disclose its contents, or to manufacture, use or sell anything it may describe. Reproduction, disclosure or use without specific written authorization of Pulse is strictly forbidden.

For more information:

Pulse Worldwide Headquarters
15255 Innovation Drive #100
San Diego, CA 92128
USA
Tel:1-858-674-8100

Pulse/Larsen Antennas
18110 SE 34th St Bldg 2 Suite 250
Vancouver, WA 98683
USA
Tel: 1-360-944-7551

Europe Headquarters
Pulse GmbH & Do, KG
Zeppelinstrasse 15
Herrenberg, Germany
Tel: 49 7032 7806 0

Pulse (Suzhou) Wireless Products Co, Inc.
99 Huo Ju Road(#29 Bldg,4th Phase
Suzhou New District
Jiangsu Province, Suzhou 215009 PR China
Tel: 86 512 6807 9998



Description: LOW PROFILE MULTIBAND ANTENNA

Series: IceFin

PART NUMBER: ICEFINXXX

This document covers all product variants of the following product family:

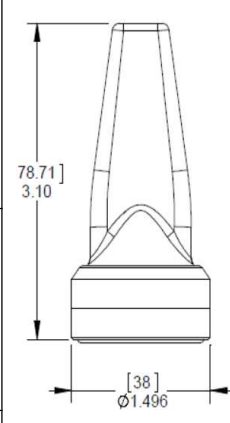
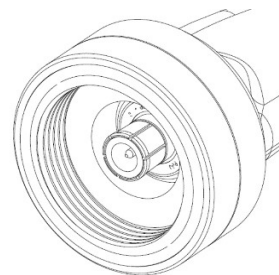
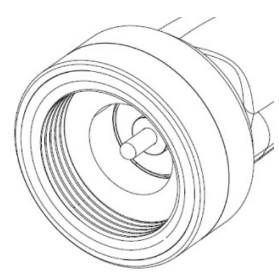
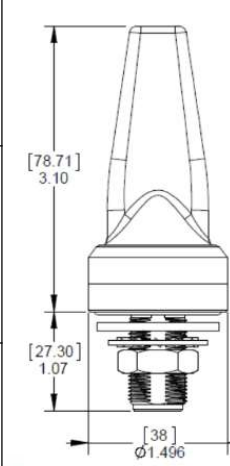
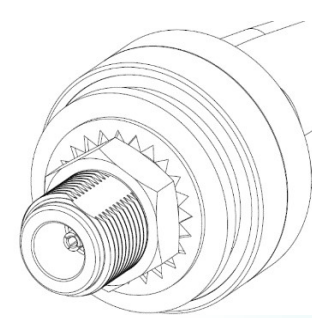
Project	Color	Frequency	Size	Fixing System Connector	
ICEFINLNMOHF	Clarity	698-960MHz 1710-2700MHz		 NMOHF NMO + HF Connector	
ICEFIN698/960NMO	Clarity	750-960MHz		 NMO Pogo Pin Connector	
ICEFIN806NMO	Clarity	806-960MHz			
ICEFIN698/869DMN	Clarity	698-869MHz		 DMN Direct Mount + N Female Connector (Screw 5/18-24 UNEF 2A)	
ICEFIN806DMN	Clarity	806-960MHz			
ICEFINLDMN	Clarity	698-960MHz 1710-2700MHz			

Issue: 1743

In the effort to improve our products, we reserve the right to make changes judged to be necessary.

CONFIDENTIAL AND PROPRIETARY INFORMATION

This document contains confidential and proprietary information of Pulse Electronics, Inc. (Pulse) and is protected by copyright, trade secret and other state and federal laws. Its receipt or possession does not convey any rights to reproduce, disclose its contents, or to manufacture, use or sell anything it may describe. Reproduction, disclosure or use without specific written authorization of Pulse is strictly forbidden.



Description: LOW PROFILE MULTIBAND ANTENNA

Series: IceFin

PART NUMBER: ICEFINXXX

This document covers all product variants of the following product family:

Project	Color	Frequency	Size	Fixing System Connector
ICEFIN24NMOHF	Clarity	2400-2500MHz		 NMOHF NMO + HF Connector
ICEFIN49NMOHF	Clarity	4900-6000MHz		
ICEFINWNMOHF	Clarity	2400-2500MHz 4900-6000MHz		
ICEFIN24DMN	Clarity	2400-2500MHz		 Direct Mount N Female Connector (Screw 5/18-24 UNEF 2A)
ICEFIN49DMN	Clarity	4900-6000MHz		
ICEFINWDMN	Clarity	2400-2500MHz 4900-6000MHz		

P.S.: For DMN fixing system, it requires a 5/8" (16mm) hole in the mounting surface.

Remove any burrs, particularly on the Roof under side of the hole. Remove paint in a narrow ring around the hole. Metal-to-metal contact between the mounting surface and mount is essential for best performance.

Issue: 1743

In the effort to improve our products, we reserve the right to make changes judged to be necessary.

CONFIDENTIAL AND PROPRIETARY INFORMATION

This document contains confidential and proprietary information of Pulse Electronics, Inc. (Pulse) and is protected by copyright, trade secret and other state and federal laws. Its receipt or possession does not convey any rights to reproduce, disclose its contents, or to manufacture, use or sell anything it may describe. Reproduction, disclosure or use without specific written authorization of Pulse is strictly forbidden.



Description: LOW PROFILE MULTIBAND ANTENNA

Series: IceFin

PART NUMBER: ICEFINXXX

ELECTRICAL SPECIFICATIONS

Project	Frequency	VSWR	Peak Gain	Efficiency	Power Handling
ICEFINLNMOHF	698-960MHz 1710-2700MHz	3.2:1(0.698-0.96GHz) 2:1(1.71-2.7GHz)	2.98dBi(0.698-0.96GHz) 3.82dBi(1.71-2.69GHz)	75% 61%	20W(100% duty cycle) 30W(50% duty cycle)
ICEFIN698/960NMO	750-960MHz	2.2:1	4.5dBi	65%	30W(100% duty cycle) 40W(50% duty cycle)
ICEFIN806NMO	806-960MHz	2.2:1	2.91dBi	63%	30W(100% duty cycle) 40W(50% duty cycle)
ICEFIN698/869DMN	698-869MHz	2.3:1	2.6dBi	54%	5W(100% duty cycle) 15W(50% duty cycle)
ICEFIN806DMN	806-960MHz	2.2:1	3.7dBi	78%	10W(100% duty cycle) 20W(50% duty cycle)
ICEFINLDMN	698-960MHz 1710-2700MHz	3.2:1(0.698-0.96GHz) 2:1(1.71-2.7GHz)	3.1dBi(0.698-0.96GHz) 5.17dBi(1.71-2.69GHz)	76% 79%	20W(100% duty cycle) 30W(50% duty cycle)

Issue: 1743

In the effort to improve our products, we reserve the right to make changes judged to be necessary.

CONFIDENTIAL AND PROPRIETARY INFORMATION

This document contains confidential and proprietary information of Pulse Electronics, Inc. (Pulse) and is protected by copyright, trade secret and other state and federal laws. Its receipt or possession does not convey any rights to reproduce, disclose its contents, or to manufacture, use or sell anything it may describe. Reproduction, disclosure or use without specific written authorization of Pulse is strictly forbidden.



Description: LOW PROFILE MULTIBAND ANTENNA

Series: IceFin

PART NUMBER: ICEFINXXX

ELECTRICAL SPECIFICATIONS

Project	Frequency	VSWR	Peak Gain	Efficiency	Power Handling
ICEFIN24NMOHF	2400-2500MHz	2:1	5.2dBi	88%	20W(100% duty cycle) 30W(50% duty cycle)
ICEFIN49NMOHF	4900-6000MHz	2:1	6.2dBi	66%	20W(100% duty cycle) 30W(50% duty cycle)
ICEFINWNMOHF	2400-2500MHz 4900-6000MHz	2:1(2.4-2.5GHz) 2:1(4.9-6GHz)	5.2dBi 6.2dBi	88% 66%	20W(100% duty cycle) 30W(50% duty cycle)
ICEFIN24DMN	2400-2500MHz	2:1	5.2dBi	88%	20W(100% duty cycle) 30W(50% duty cycle)
ICEFIN49DMN	4900-6000MHz	2:1	6.2dBi	66%	20W(100% duty cycle) 30W(50% duty cycle)
ICEFINWDMN	2400-2500MHz 4900-6000MHz	2:1(2.4-2.5GHz) 2:1(4.9-6GHz)	5.2dBi 6.2dBi	88% 66%	20W(100% duty cycle) 30W(50% duty cycle)

Nominal Impedance

50Ω

Radiation Pattern

omni

Polarization:

Vertical

Issue: 1743

In the effort to improve our products, we reserve the right to make changes judged to be necessary.

CONFIDENTIAL AND PROPRIETARY INFORMATION

This document contains confidential and proprietary information of Pulse Electronics, Inc. (Pulse) and is protected by copyright, trade secret and other state and federal laws. Its receipt or possession does not convey any rights to reproduce, disclose its contents, or to manufacture, use or sell anything it may describe. Reproduction, disclosure or use without specific written authorization of Pulse is strictly forbidden.



Description: LOW PROFILE MULTIBAND
ANTENNA

Series: IceFin

PART NUMBER: ICEFINXXX

MECHANICAL SPECIFICATIONS

Plastic radome	PC
Color	Clarity
Ingress Protection	IP67

ENVIRONMENTAL SPECIFICATIONS

Operating temperature	-40 ~ +85° C
-----------------------	--------------

Issue: 1743

In the effort to improve our products, we reserve the right to make changes judged to be necessary.

CONFIDENTIAL AND PROPRIETARY INFORMATION

This document contains confidential and proprietary information of Pulse Electronics, Inc. (Pulse) and is protected by copyright, trade secret and other state and federal laws. Its receipt or possession does not convey any rights to reproduce, disclose its contents, or to manufacture, use or sell anything it may describe. Reproduction, disclosure or use without specific written authorization of Pulse is strictly forbidden.

Description: LOW PROFILE MULTIBAND ANTENNA

Series: IceFin

PART NUMBER: ICEFINXXX

CHARTS

VSWR

ICEFINLNMOHF
VSWR

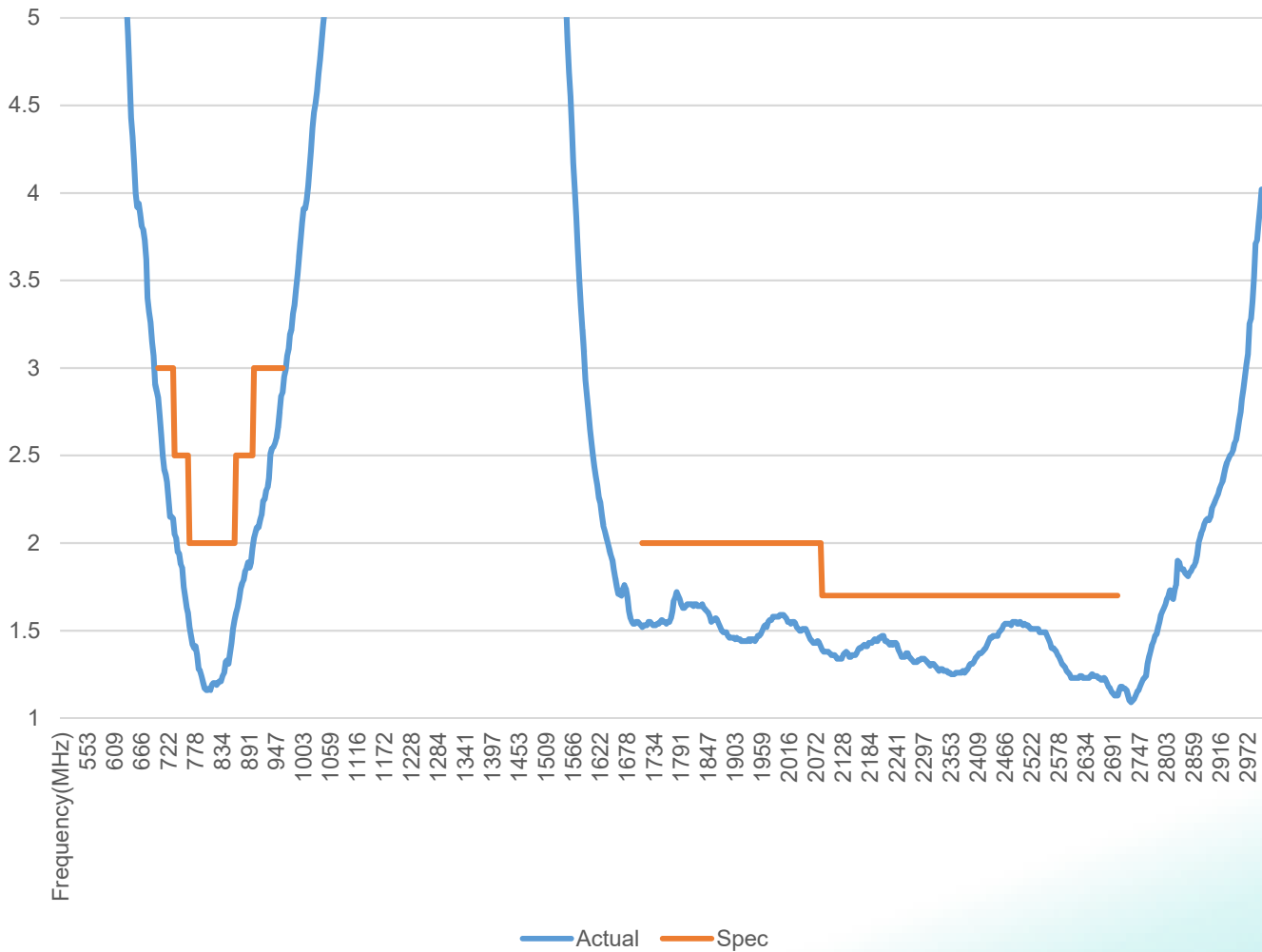

Issue: 1743

In the effort to improve our products, we reserve the right to make changes judged to be necessary.

CONFIDENTIAL AND PROPRIETARY INFORMATION

This document contains confidential and proprietary information of Pulse Electronics, Inc. (Pulse) and is protected by copyright, trade secret and other state and federal laws. Its receipt or possession does not convey any rights to reproduce, disclose its contents, or to manufacture, use or sell anything it may describe. Reproduction, disclosure or use without specific written authorization of Pulse is strictly forbidden.



Description: LOW PROFILE MULTIBAND ANTENNA

Series: IceFin

PART NUMBER: ICEFINXXX

CHARTS

VSWR

ICEFIN698/960NMO
VSWR

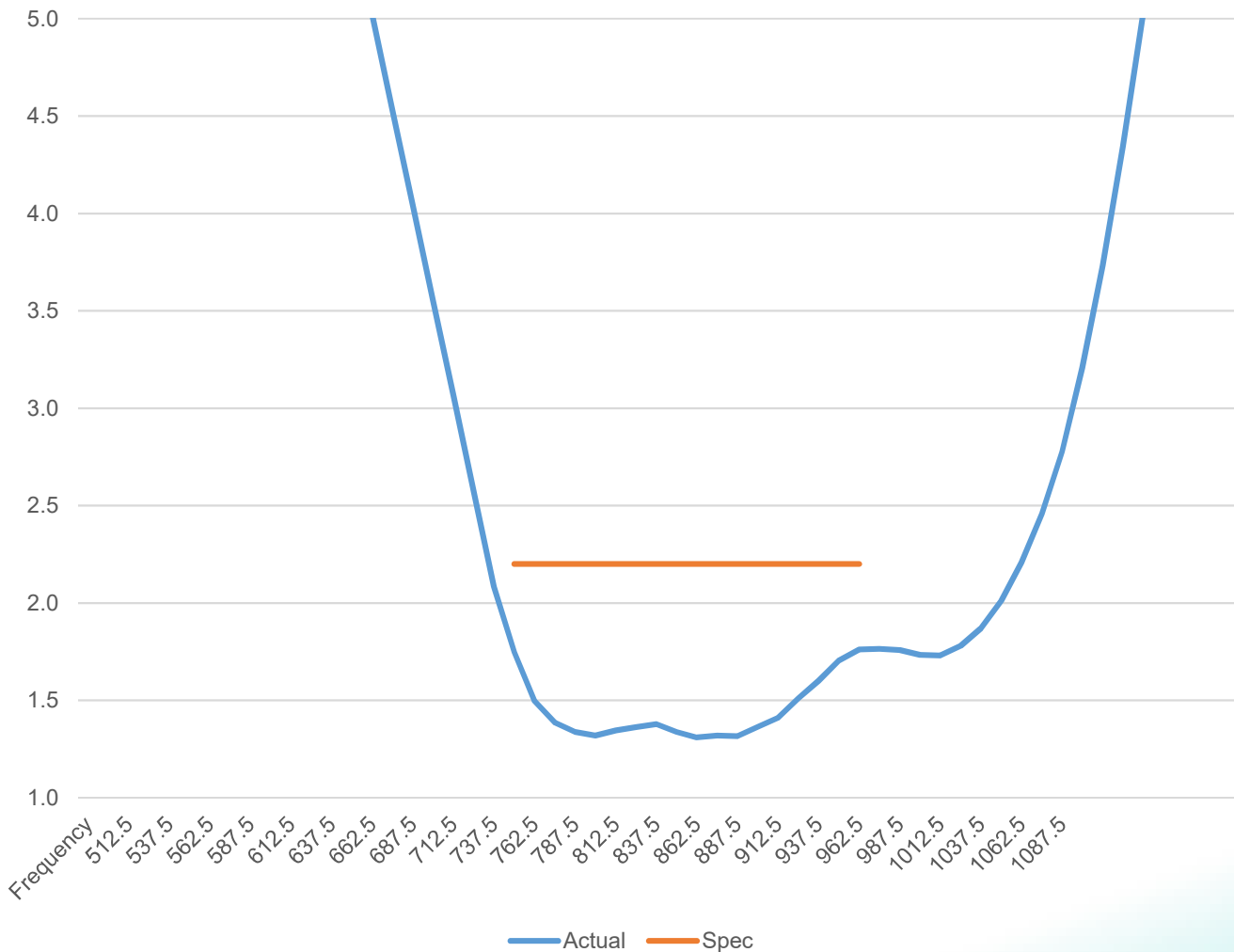

Issue: 1743

In the effort to improve our products, we reserve the right to make changes judged to be necessary.

CONFIDENTIAL AND PROPRIETARY INFORMATION

This document contains confidential and proprietary information of Pulse Electronics, Inc. (Pulse) and is protected by copyright, trade secret and other state and federal laws. Its receipt or possession does not convey any rights to reproduce, disclose its contents, or to manufacture, use or sell anything it may describe. Reproduction, disclosure or use without specific written authorization of Pulse is strictly forbidden.



Description: LOW PROFILE MULTIBAND ANTENNA

Series: IceFin

PART NUMBER: ICEFINXXX

CHARTS

VSWR

ICEFIN806NMO
VSWR



Issue: 1743

In the effort to improve our products, we reserve the right to make changes judged to be necessary.

CONFIDENTIAL AND PROPRIETARY INFORMATION

This document contains confidential and proprietary information of Pulse Electronics, Inc. (Pulse) and is protected by copyright, trade secret and other state and federal laws. Its receipt or possession does not convey any rights to reproduce, disclose its contents, or to manufacture, use or sell anything it may describe. Reproduction, disclosure or use without specific written authorization of Pulse is strictly forbidden.



Description: LOW PROFILE MULTIBAND ANTENNA

Series: IceFin

PART NUMBER: ICEFINXXX

CHARTS

VSWR

ICEFIN698/869DMN
VSWR



Issue: 1743

In the effort to improve our products, we reserve the right to make changes judged to be necessary.

CONFIDENTIAL AND PROPRIETARY INFORMATION

This document contains confidential and proprietary information of Pulse Electronics, Inc. (Pulse) and is protected by copyright, trade secret and other state and federal laws. Its receipt or possession does not convey any rights to reproduce, disclose its contents, or to manufacture, use or sell anything it may describe. Reproduction, disclosure or use without specific written authorization of Pulse is strictly forbidden.



Description: LOW PROFILE MULTIBAND ANTENNA

Series: IceFin

PART NUMBER: ICEFINXXX

CHARTS

VSWR

ICEFIN806DMN
VSWR

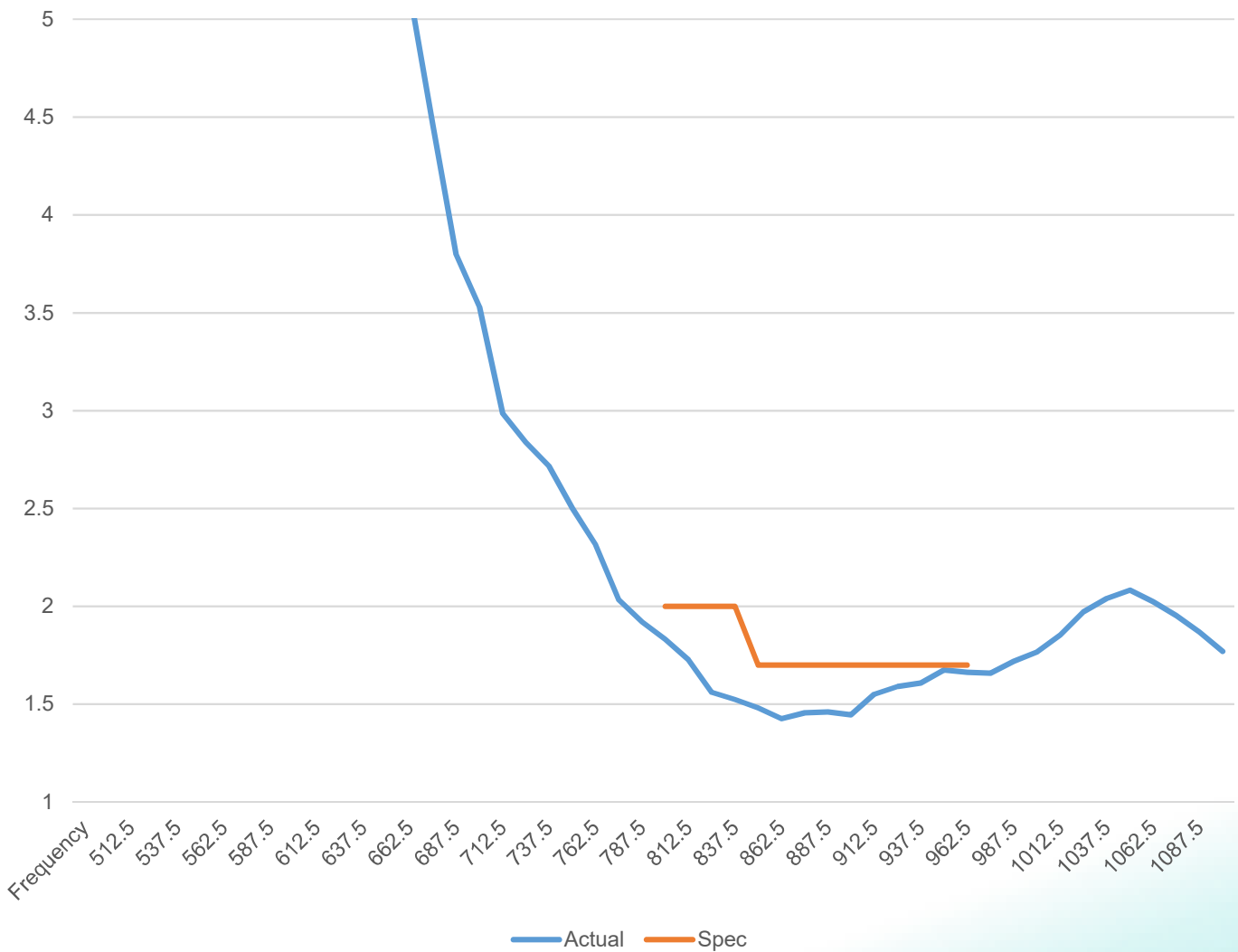

Issue: 1743

In the effort to improve our products, we reserve the right to make changes judged to be necessary.

CONFIDENTIAL AND PROPRIETARY INFORMATION

This document contains confidential and proprietary information of Pulse Electronics, Inc. (Pulse) and is protected by copyright, trade secret and other state and federal laws. Its receipt or possession does not convey any rights to reproduce, disclose its contents, or to manufacture, use or sell anything it may describe. Reproduction, disclosure or use without specific written authorization of Pulse is strictly forbidden.



Description: LOW PROFILE MULTIBAND ANTENNA

Series: IceFin

PART NUMBER: ICEFINXXX

CHARTS

VSWR

ICEFINLDMN
VSWR

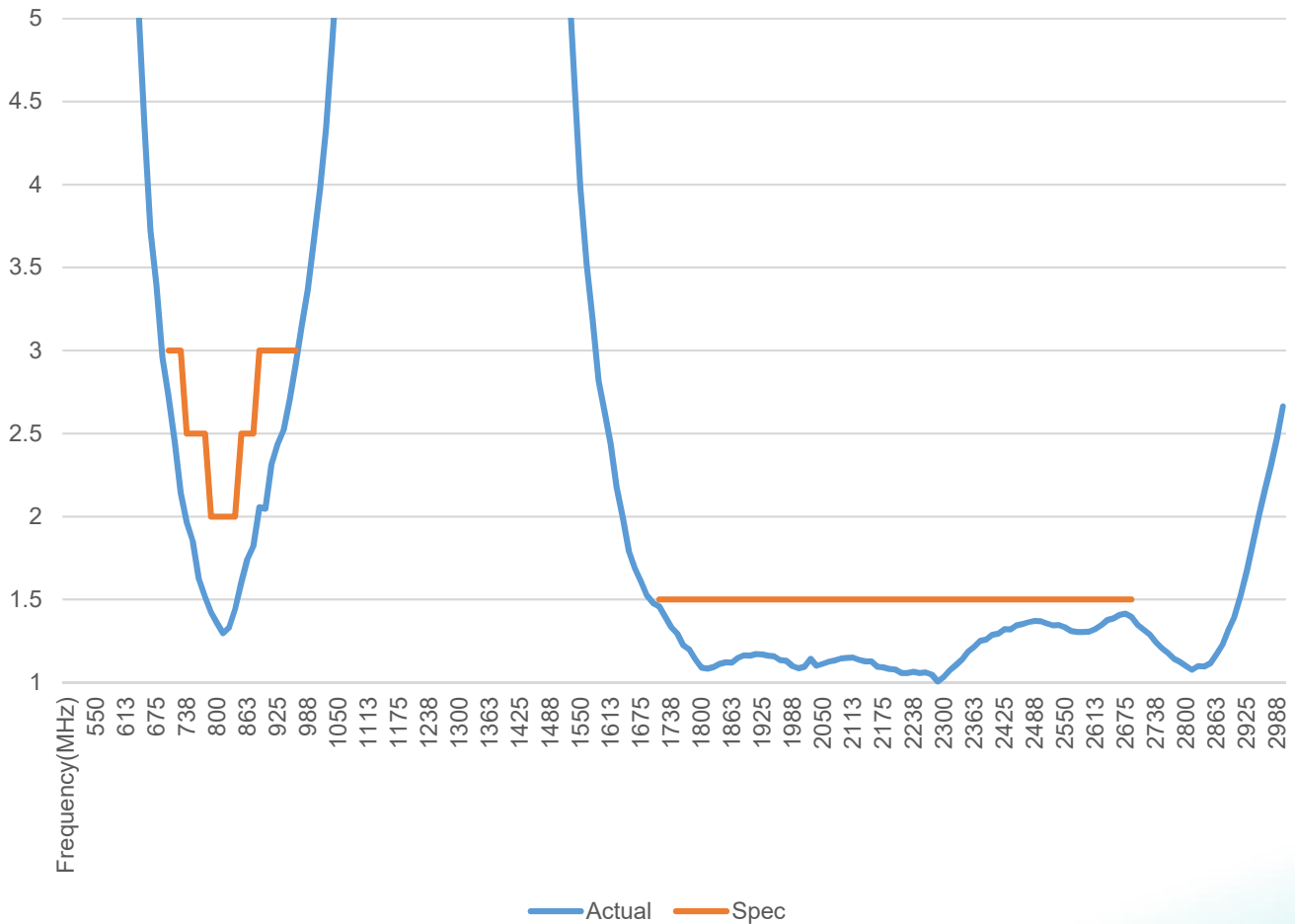

Issue: 1743

In the effort to improve our products, we reserve the right to make changes judged to be necessary.

CONFIDENTIAL AND PROPRIETARY INFORMATION

This document contains confidential and proprietary information of Pulse Electronics, Inc. (Pulse) and is protected by copyright, trade secret and other state and federal laws. Its receipt or possession does not convey any rights to reproduce, disclose its contents, or to manufacture, use or sell anything it may describe. Reproduction, disclosure or use without specific written authorization of Pulse is strictly forbidden.



Description: LOW PROFILE MULTIBAND ANTENNA

Series: IceFin

PART NUMBER: ICEFINXXX

CHARTS

VSWR

ICEFIN24NMOHF
VSWR



Issue: 1743

In the effort to improve our products, we reserve the right to make changes judged to be necessary.

CONFIDENTIAL AND PROPRIETARY INFORMATION

This document contains confidential and proprietary information of Pulse Electronics, Inc. (Pulse) and is protected by copyright, trade secret and other state and federal laws. Its receipt or possession does not convey any rights to reproduce, disclose its contents, or to manufacture, use or sell anything it may describe. Reproduction, disclosure or use without specific written authorization of Pulse is strictly forbidden.



Description: LOW PROFILE MULTIBAND ANTENNA

Series: IceFin

PART NUMBER: ICEFINXXX

CHARTS

VSWR

**ICEFIN49NMOHF
VSWR**



Issue: 1743

In the effort to improve our products, we reserve the right to make changes judged to be necessary.

CONFIDENTIAL AND PROPRIETARY INFORMATION

This document contains confidential and proprietary information of Pulse Electronics, Inc. (Pulse) and is protected by copyright, trade secret and other state and federal laws. Its receipt or possession does not convey any rights to reproduce, disclose its contents, or to manufacture, use or sell anything it may describe. Reproduction, disclosure or use without specific written authorization of Pulse is strictly forbidden.



Description: LOW PROFILE MULTIBAND ANTENNA

Series: IceFin

PART NUMBER: ICEFINXXX

CHARTS

VSWR

ICEFINWNMOHF
VSWR



Issue: 1743

In the effort to improve our products, we reserve the right to make changes judged to be necessary.

CONFIDENTIAL AND PROPRIETARY INFORMATION

This document contains confidential and proprietary information of Pulse Electronics, Inc. (Pulse) and is protected by copyright, trade secret and other state and federal laws. Its receipt or possession does not convey any rights to reproduce, disclose its contents, or to manufacture, use or sell anything it may describe. Reproduction, disclosure or use without specific written authorization of Pulse is strictly forbidden.



Description: LOW PROFILE MULTIBAND ANTENNA

Series: IceFin

PART NUMBER: ICEFINXXX

CHARTS

VSWR

ICEFIN24DMN
VSWR

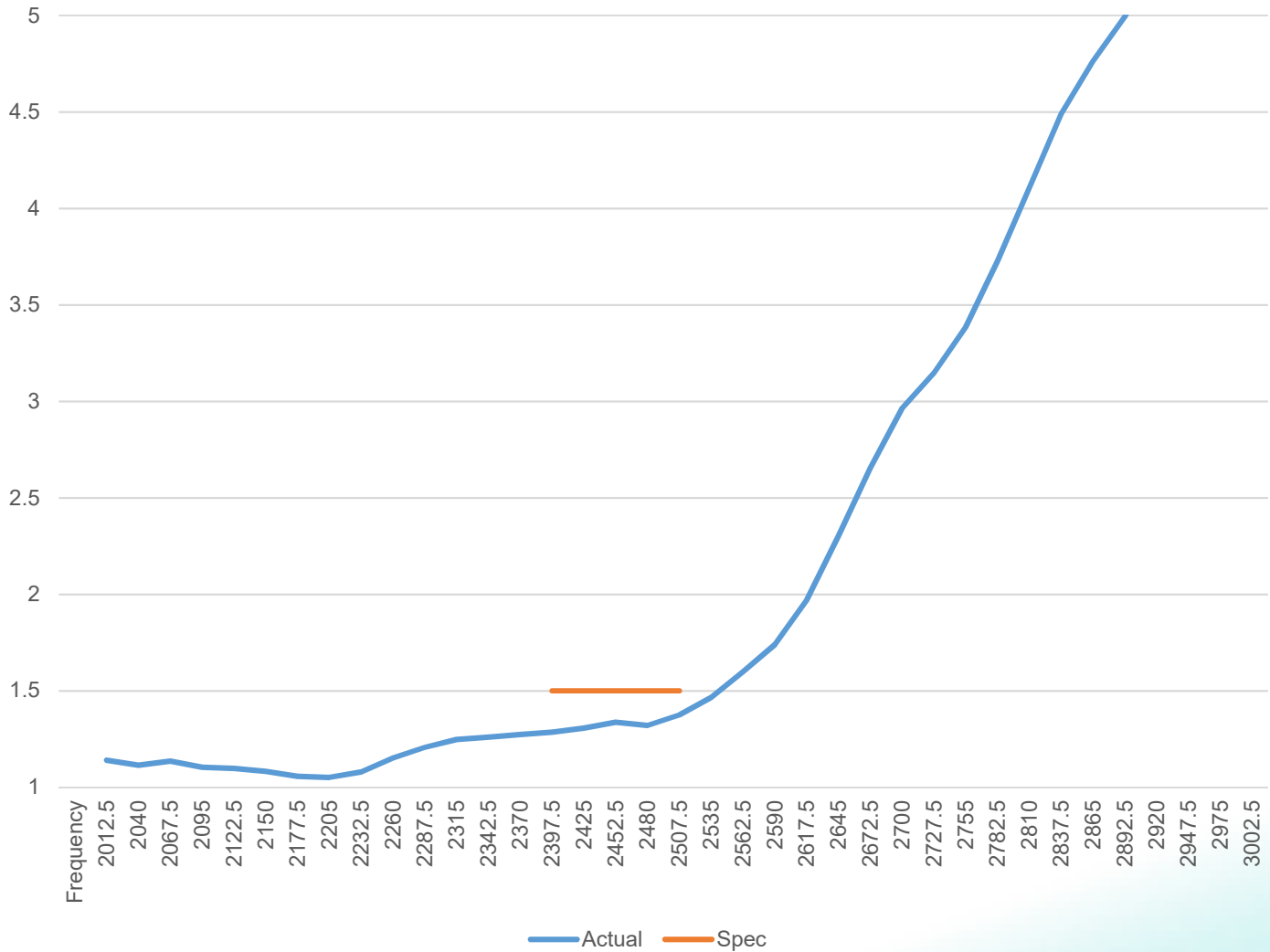

Issue: 1743

In the effort to improve our products, we reserve the right to make changes judged to be necessary.

CONFIDENTIAL AND PROPRIETARY INFORMATION

This document contains confidential and proprietary information of Pulse Electronics, Inc. (Pulse) and is protected by copyright, trade secret and other state and federal laws. Its receipt or possession does not convey any rights to reproduce, disclose its contents, or to manufacture, use or sell anything it may describe. Reproduction, disclosure or use without specific written authorization of Pulse is strictly forbidden.



Description: LOW PROFILE MULTIBAND ANTENNA

Series: IceFin

PART NUMBER: ICEFINXXX

CHARTS

VSWR

**ICEFIN49DMN
VSWR**

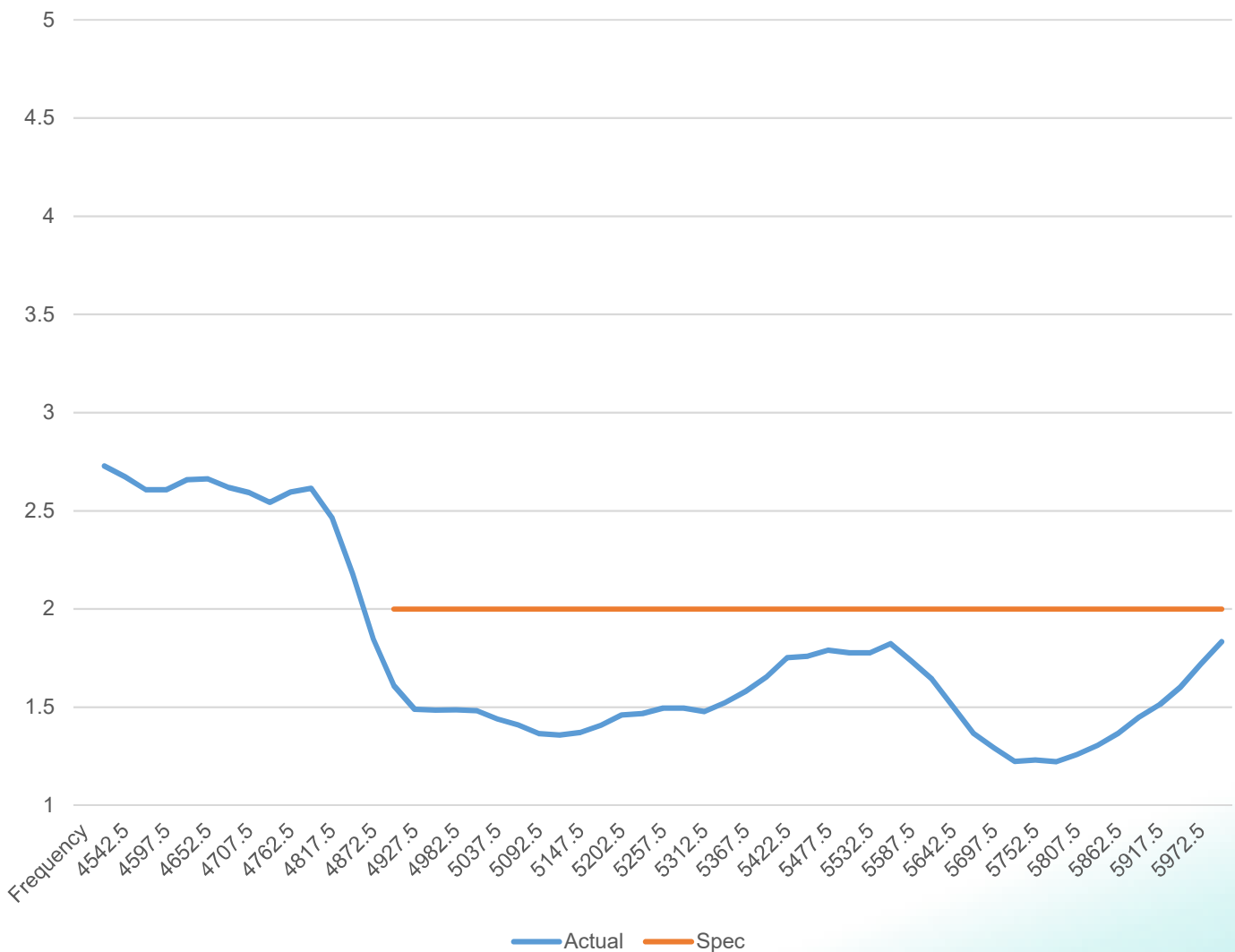

Issue: 1743

In the effort to improve our products, we reserve the right to make changes judged to be necessary.

CONFIDENTIAL AND PROPRIETARY INFORMATION

This document contains confidential and proprietary information of Pulse Electronics, Inc. (Pulse) and is protected by copyright, trade secret and other state and federal laws. Its receipt or possession does not convey any rights to reproduce, disclose its contents, or to manufacture, use or sell anything it may describe. Reproduction, disclosure or use without specific written authorization of Pulse is strictly forbidden.



Description: LOW PROFILE MULTIBAND ANTENNA

Series: IceFin

PART NUMBER: ICEFINXXX

CHARTS

VSWR

ICEFINWDMN
VSWR

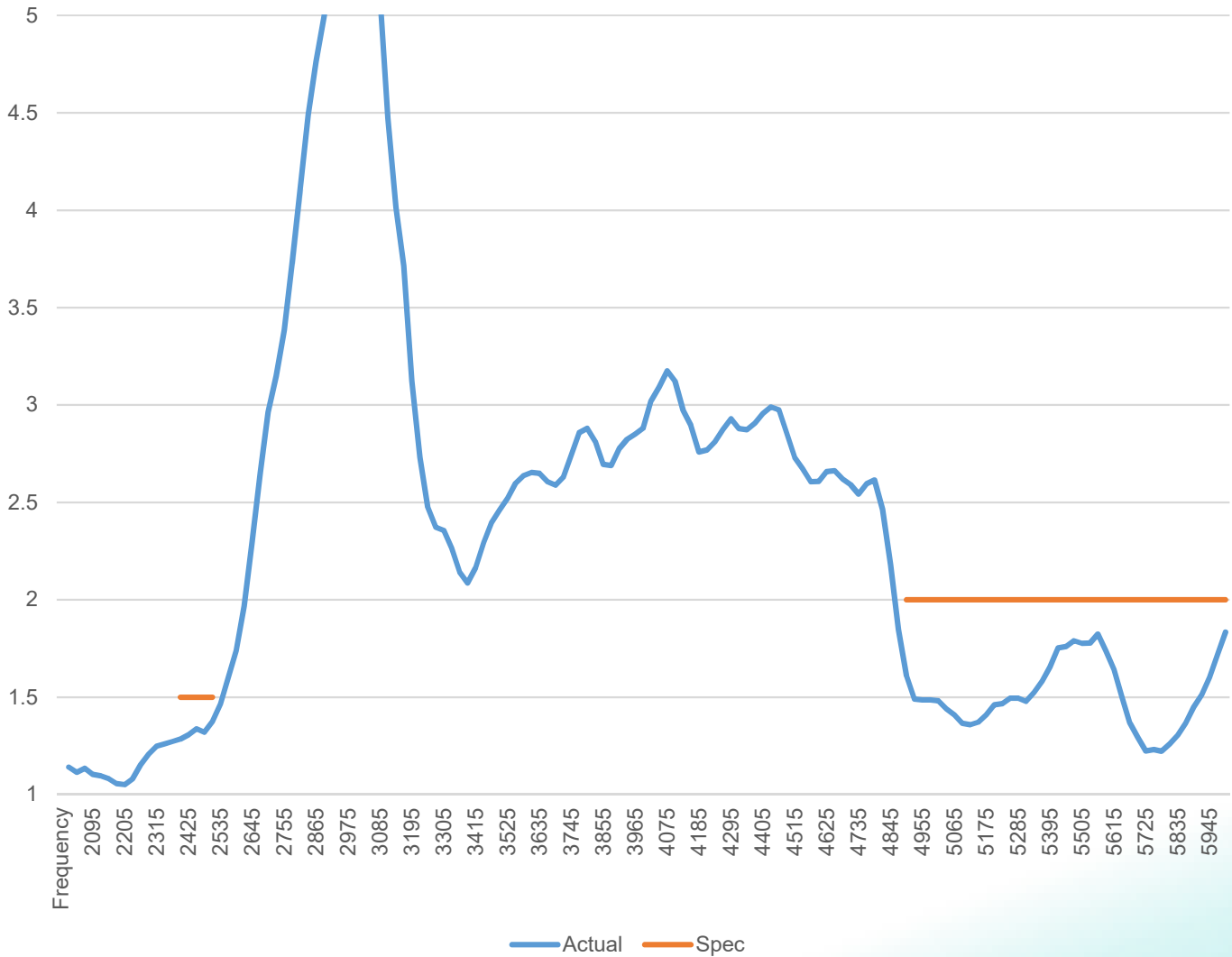

Issue: 1743

In the effort to improve our products, we reserve the right to make changes judged to be necessary.

CONFIDENTIAL AND PROPRIETARY INFORMATION

This document contains confidential and proprietary information of Pulse Electronics, Inc. (Pulse) and is protected by copyright, trade secret and other state and federal laws. Its receipt or possession does not convey any rights to reproduce, disclose its contents, or to manufacture, use or sell anything it may describe. Reproduction, disclosure or use without specific written authorization of Pulse is strictly forbidden.



Description: LOW PROFILE MULTIBAND ANTENNA

Series: IceFin

PART NUMBER: ICEFINXXX

CHARTS

Efficiency(%)

ICEFINLNMOHF
Efficiency (%)

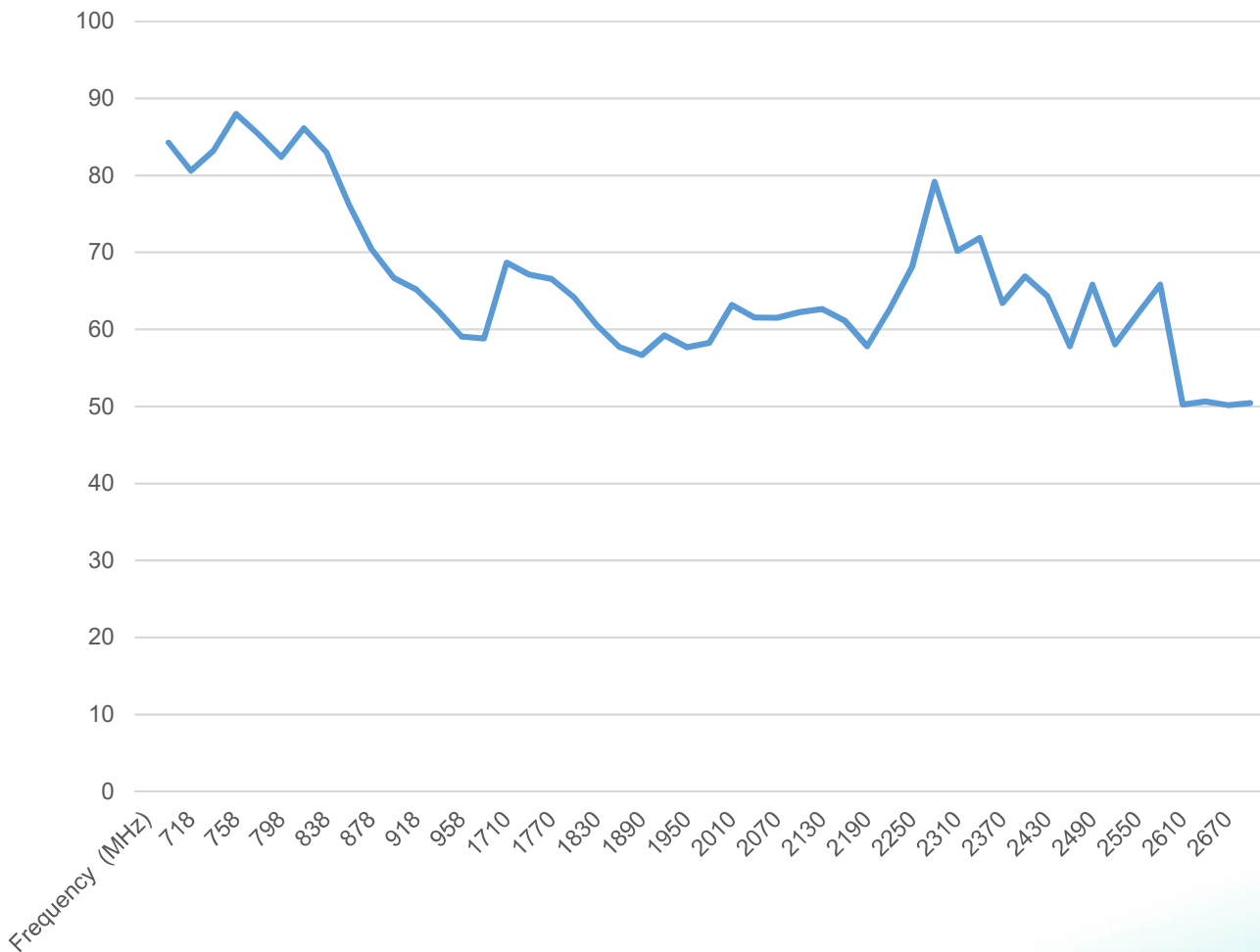

Issue: 1743

In the effort to improve our products, we reserve the right to make changes judged to be necessary.

CONFIDENTIAL AND PROPRIETARY INFORMATION

This document contains confidential and proprietary information of Pulse Electronics, Inc. (Pulse) and is protected by copyright, trade secret and other state and federal laws. Its receipt or possession does not convey any rights to reproduce, disclose its contents, or to manufacture, use or sell anything it may describe. Reproduction, disclosure or use without specific written authorization of Pulse is strictly forbidden.

Description: LOW PROFILE MULTIBAND ANTENNA

Series: IceFin

PART NUMBER: ICEFINXXX

CHARTS

Efficiency(%)

ICEFIN698/960NMO
Efficiency (%)

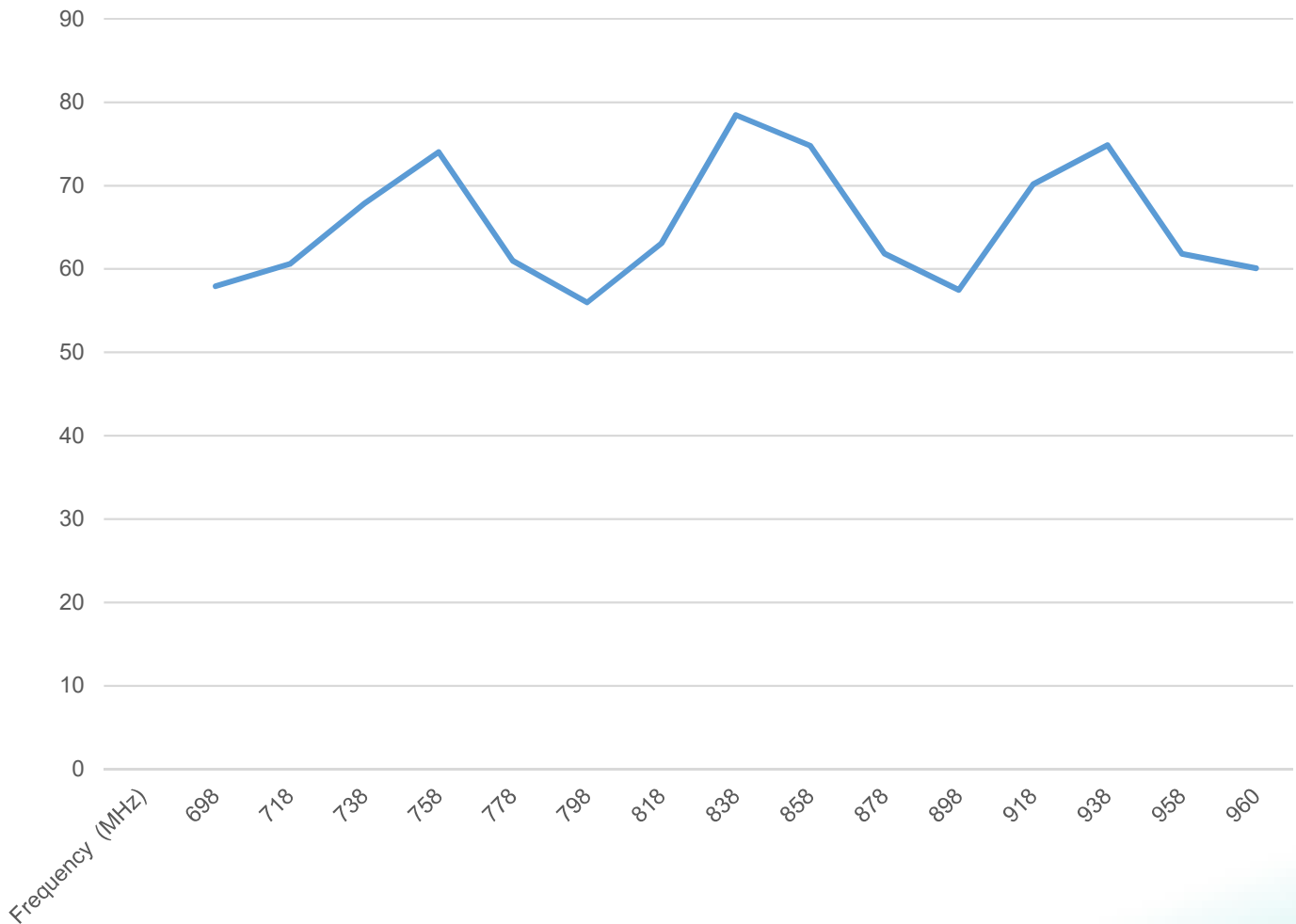

Issue: 1743

In the effort to improve our products, we reserve the right to make changes judged to be necessary.

CONFIDENTIAL AND PROPRIETARY INFORMATION

This document contains confidential and proprietary information of Pulse Electronics, Inc. (Pulse) and is protected by copyright, trade secret and other state and federal laws. Its receipt or possession does not convey any rights to reproduce, disclose its contents, or to manufacture, use or sell anything it may describe. Reproduction, disclosure or use without specific written authorization of Pulse is strictly forbidden.



Description: LOW PROFILE MULTIBAND ANTENNA

Series: IceFin

PART NUMBER: ICEFINXXX

CHARTS

Efficiency(%)

ICEFIN806NMO
Efficiency (%)

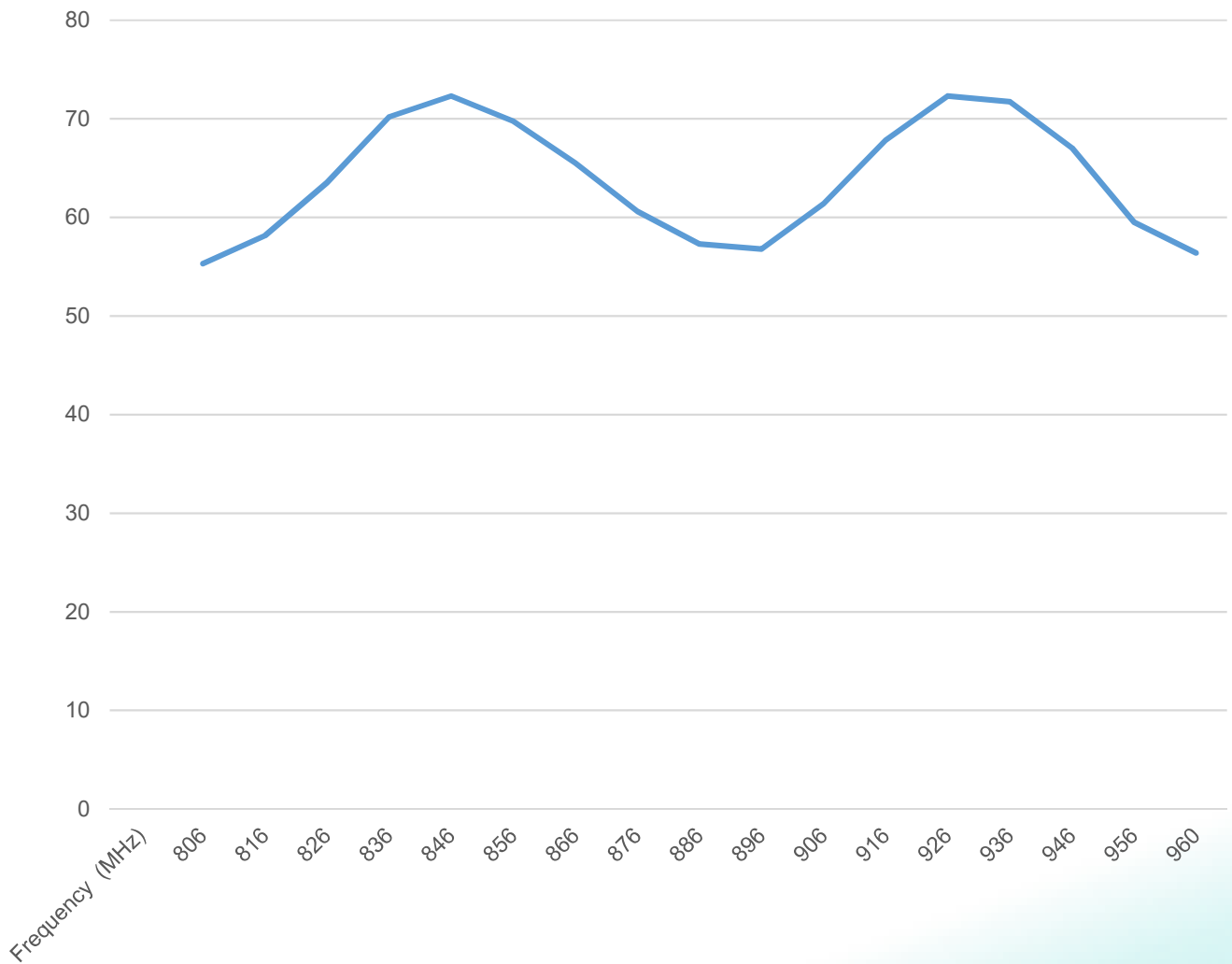

Issue: 1743

In the effort to improve our products, we reserve the right to make changes judged to be necessary.

CONFIDENTIAL AND PROPRIETARY INFORMATION

This document contains confidential and proprietary information of Pulse Electronics, Inc. (Pulse) and is protected by copyright, trade secret and other state and federal laws. Its receipt or possession does not convey any rights to reproduce, disclose its contents, or to manufacture, use or sell anything it may describe. Reproduction, disclosure or use without specific written authorization of Pulse is strictly forbidden.



Description: LOW PROFILE MULTIBAND ANTENNA

Series: IceFin

PART NUMBER: ICEFINXXX

CHARTS

Efficiency(%)

ICEFIN698/869DMN
Efficiency (%)

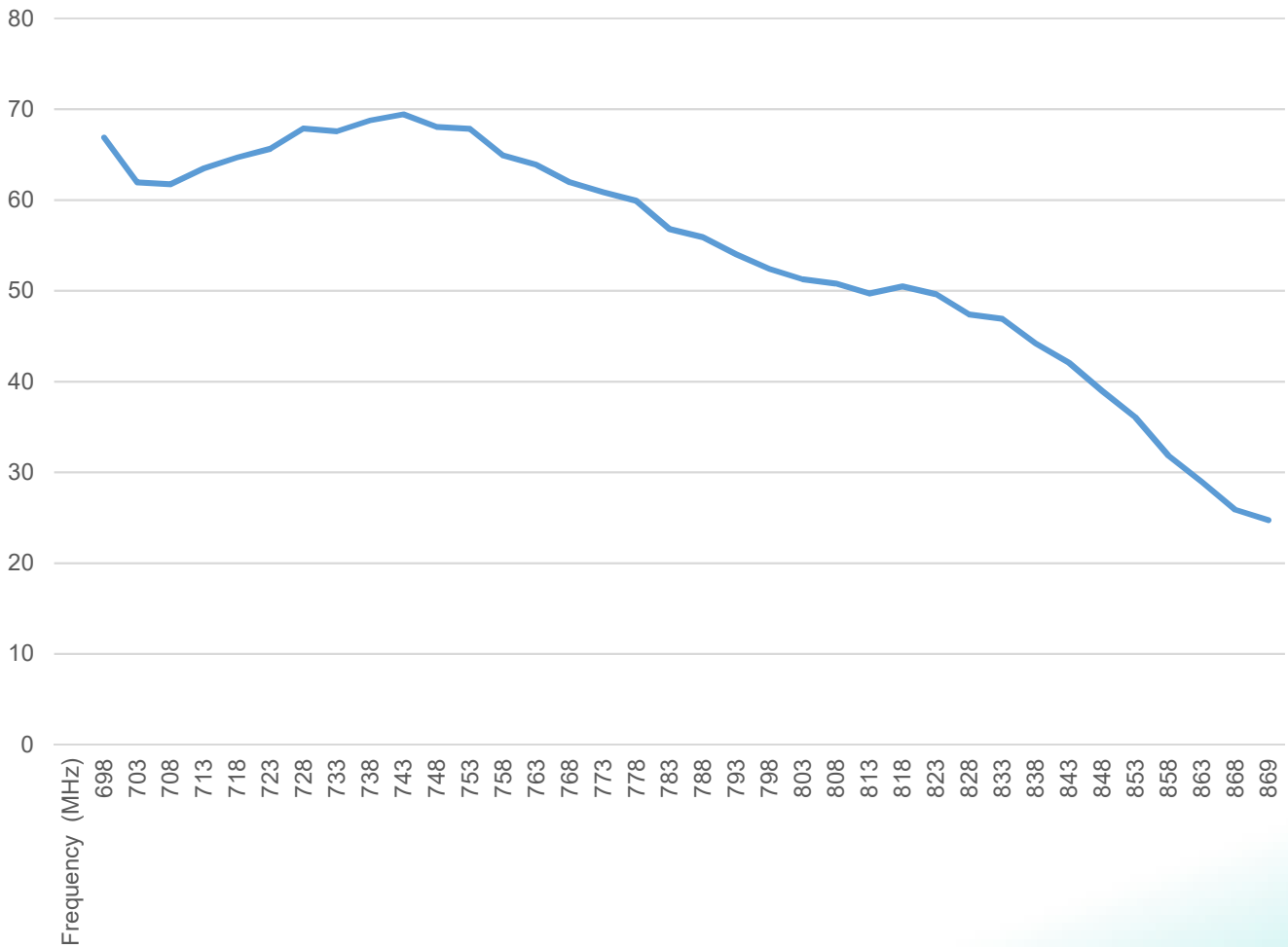

Issue: 1743

In the effort to improve our products, we reserve the right to make changes judged to be necessary.

CONFIDENTIAL AND PROPRIETARY INFORMATION

This document contains confidential and proprietary information of Pulse Electronics, Inc. (Pulse) and is protected by copyright, trade secret and other state and federal laws. Its receipt or possession does not convey any rights to reproduce, disclose its contents, or to manufacture, use or sell anything it may describe. Reproduction, disclosure or use without specific written authorization of Pulse is strictly forbidden.



Description: LOW PROFILE MULTIBAND ANTENNA

Series: IceFin

PART NUMBER: ICEFINXXX

CHARTS

Efficiency(%)

ICEFIN806DMN
Efficiency (%)

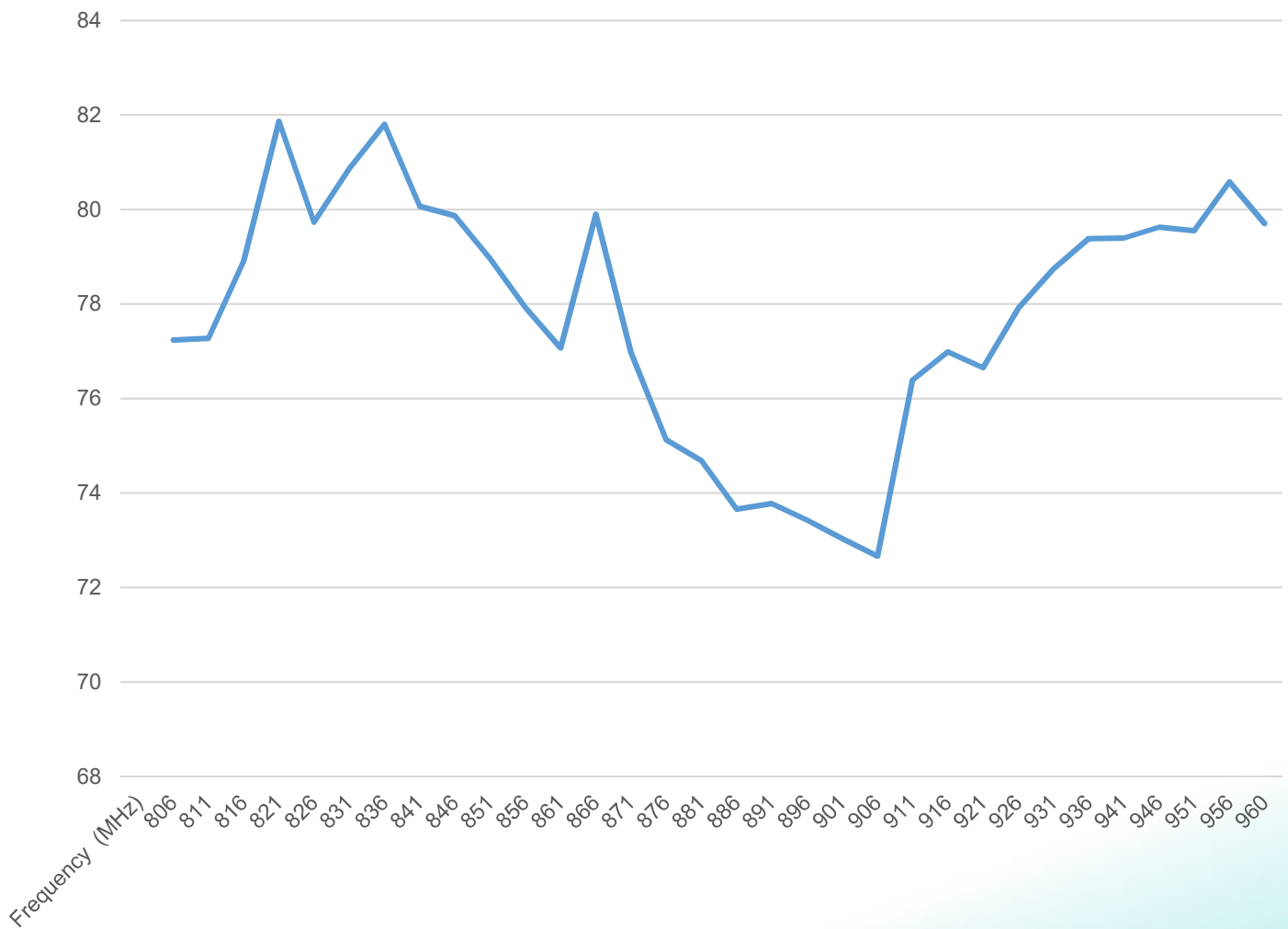

Issue: 1743

In the effort to improve our products, we reserve the right to make changes judged to be necessary.

CONFIDENTIAL AND PROPRIETARY INFORMATION

This document contains confidential and proprietary information of Pulse Electronics, Inc. (Pulse) and is protected by copyright, trade secret and other state and federal laws. Its receipt or possession does not convey any rights to reproduce, disclose its contents, or to manufacture, use or sell anything it may describe. Reproduction, disclosure or use without specific written authorization of Pulse is strictly forbidden.



Description: LOW PROFILE MULTIBAND ANTENNA

Series: IceFin

PART NUMBER: ICEFINXXX

CHARTS

Efficiency(%)

ICEFINLDMN
Efficiency (%)

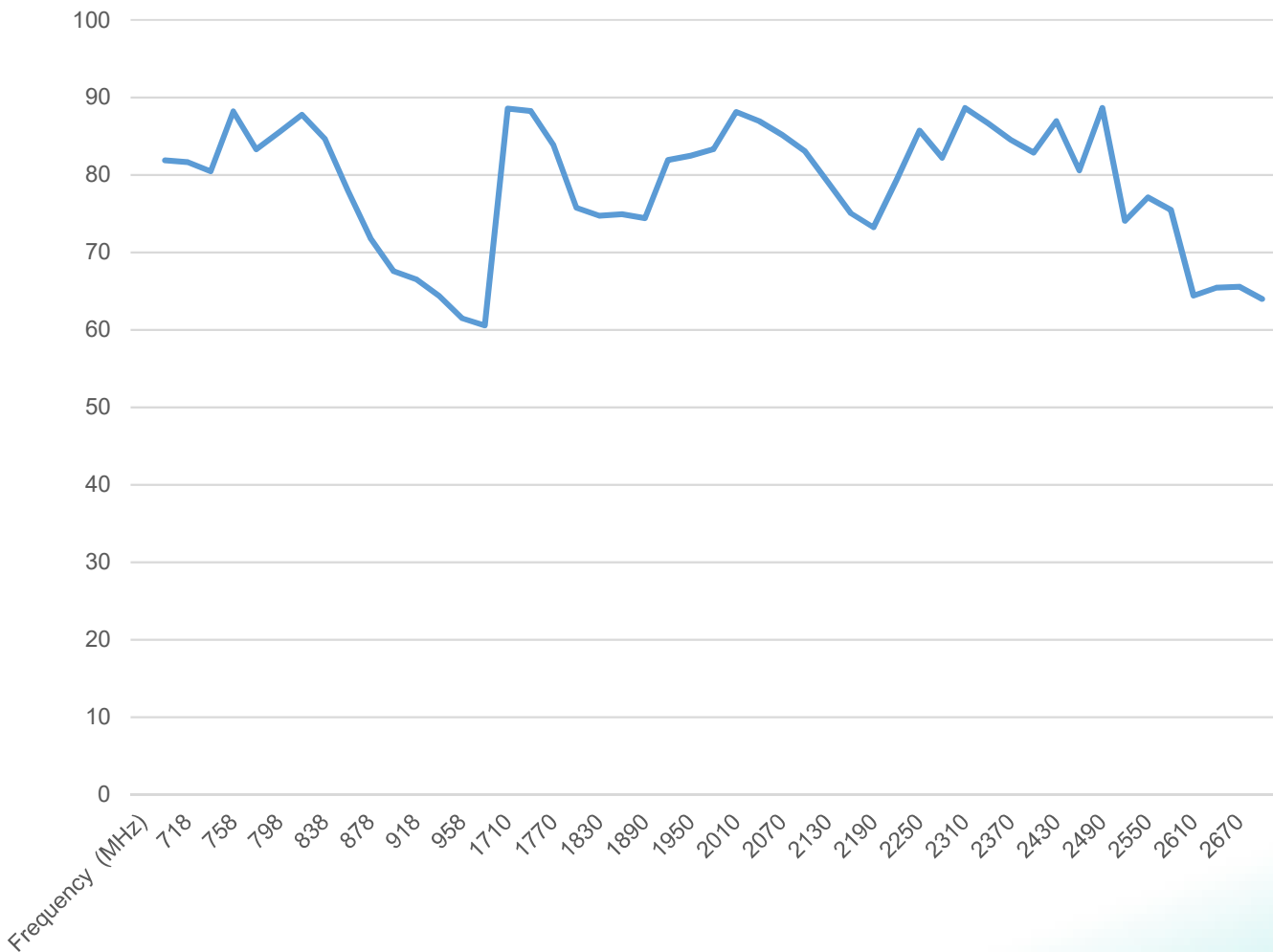

Issue: 1743

In the effort to improve our products, we reserve the right to make changes judged to be necessary.

CONFIDENTIAL AND PROPRIETARY INFORMATION

This document contains confidential and proprietary information of Pulse Electronics, Inc. (Pulse) and is protected by copyright, trade secret and other state and federal laws. Its receipt or possession does not convey any rights to reproduce, disclose its contents, or to manufacture, use or sell anything it may describe. Reproduction, disclosure or use without specific written authorization of Pulse is strictly forbidden.



Description: LOW PROFILE MULTIBAND
ANTENNA

Series: IceFin

PART NUMBER: ICEFINXXX

CHARTS

Efficiency(%)

ICEFIN24NMOHF
Efficiency (%)

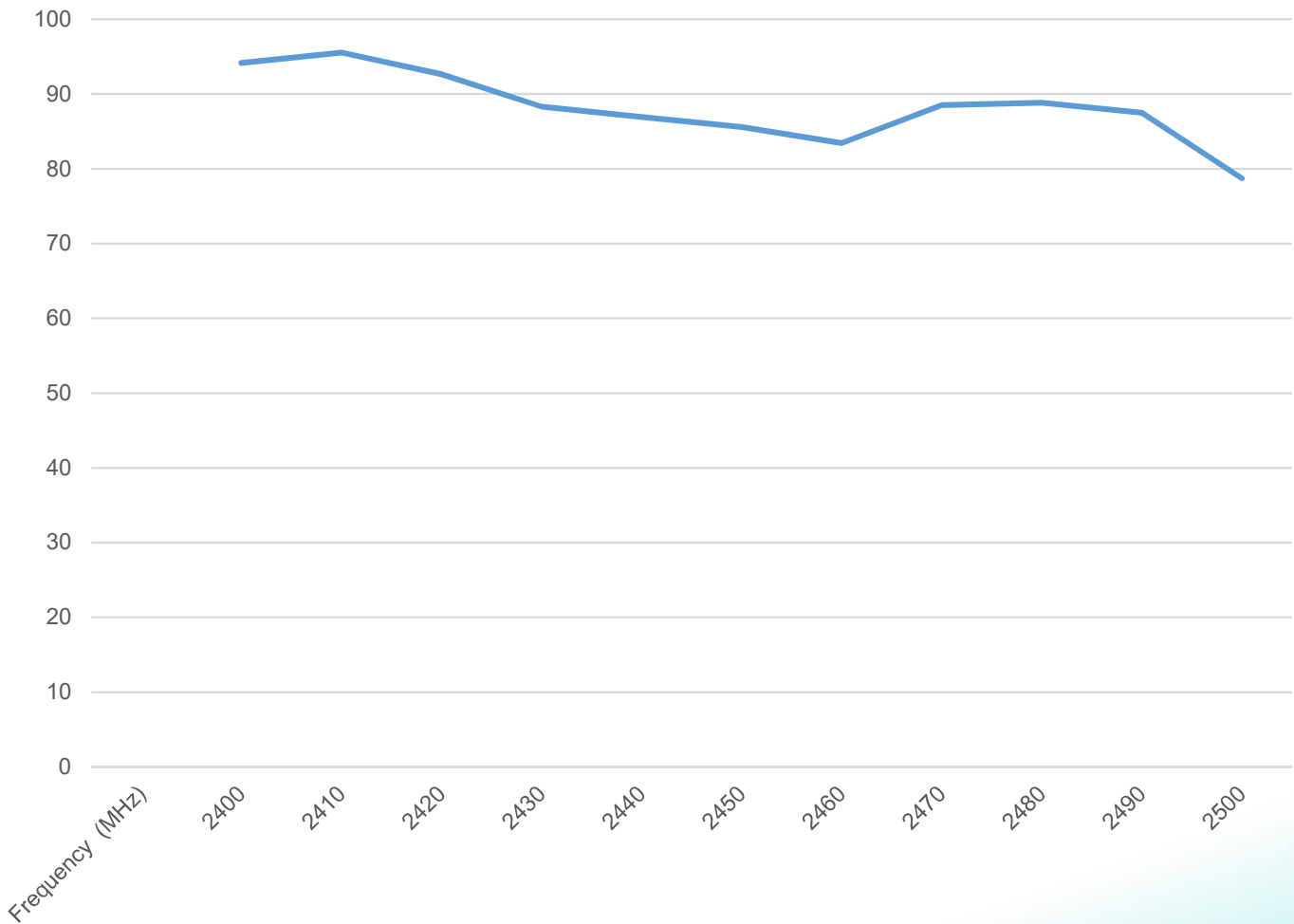

Issue: 1743

In the effort to improve our products, we reserve the right to make changes judged to be necessary.

CONFIDENTIAL AND PROPRIETARY INFORMATION

This document contains confidential and proprietary information of Pulse Electronics, Inc. (Pulse) and is protected by copyright, trade secret and other state and federal laws. Its receipt or possession does not convey any rights to reproduce, disclose its contents, or to manufacture, use or sell anything it may describe. Reproduction, disclosure or use without specific written authorization of Pulse is strictly forbidden.



Description: LOW PROFILE MULTIBAND ANTENNA

Series: IceFin

PART NUMBER: ICEFINXXX

CHARTS

Efficiency(%)

ICEFIN49NMOHF
Efficiency (%)

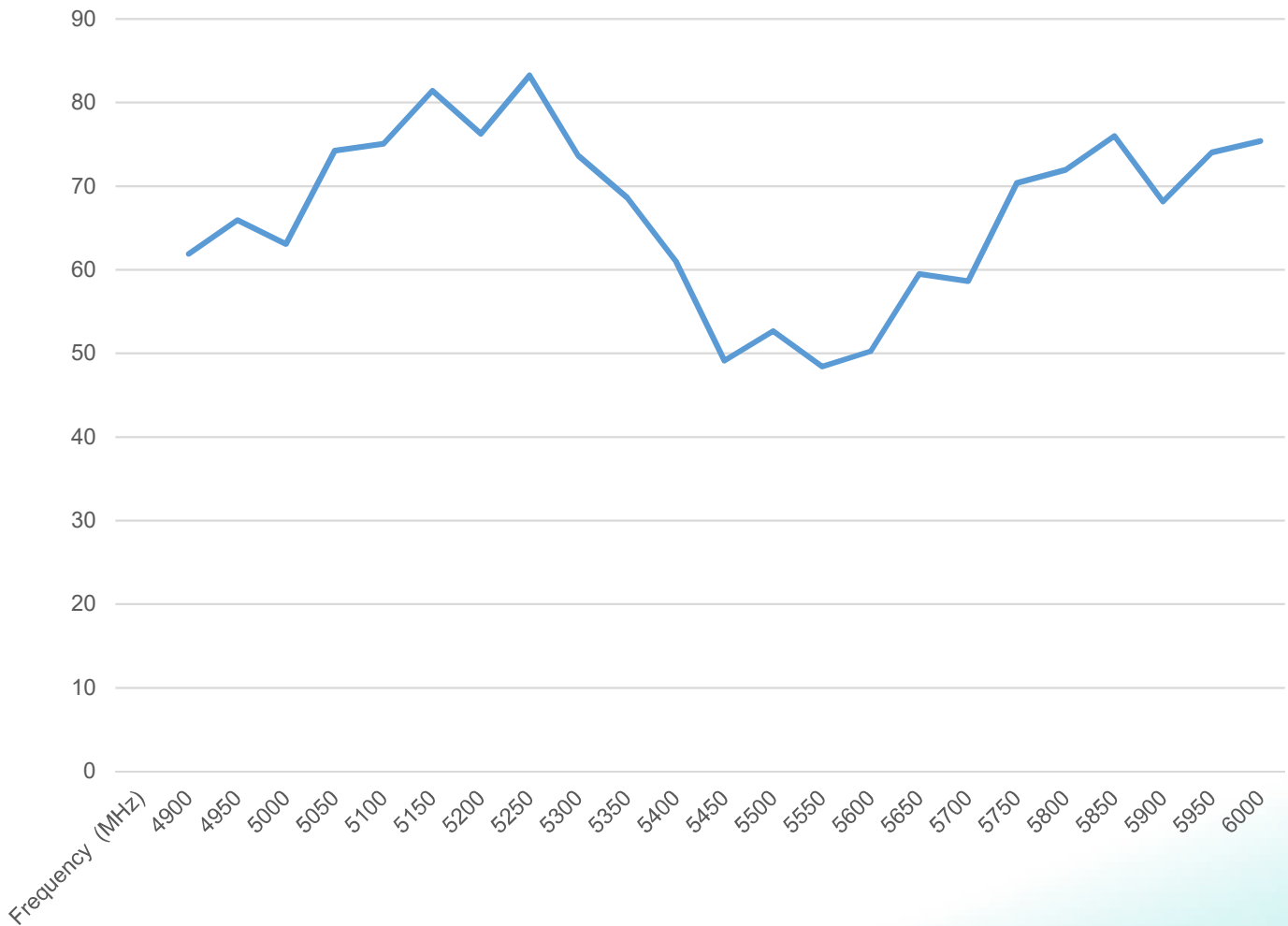

Issue: 1743

In the effort to improve our products, we reserve the right to make changes judged to be necessary.

CONFIDENTIAL AND PROPRIETARY INFORMATION

This document contains confidential and proprietary information of Pulse Electronics, Inc. (Pulse) and is protected by copyright, trade secret and other state and federal laws. Its receipt or possession does not convey any rights to reproduce, disclose its contents, or to manufacture, use or sell anything it may describe. Reproduction, disclosure or use without specific written authorization of Pulse is strictly forbidden.



Description: LOW PROFILE MULTIBAND ANTENNA

Series: IceFin

PART NUMBER: ICEFINXXX

CHARTS

Efficiency(%)

ICEFINWNMOHF
Efficiency (%)

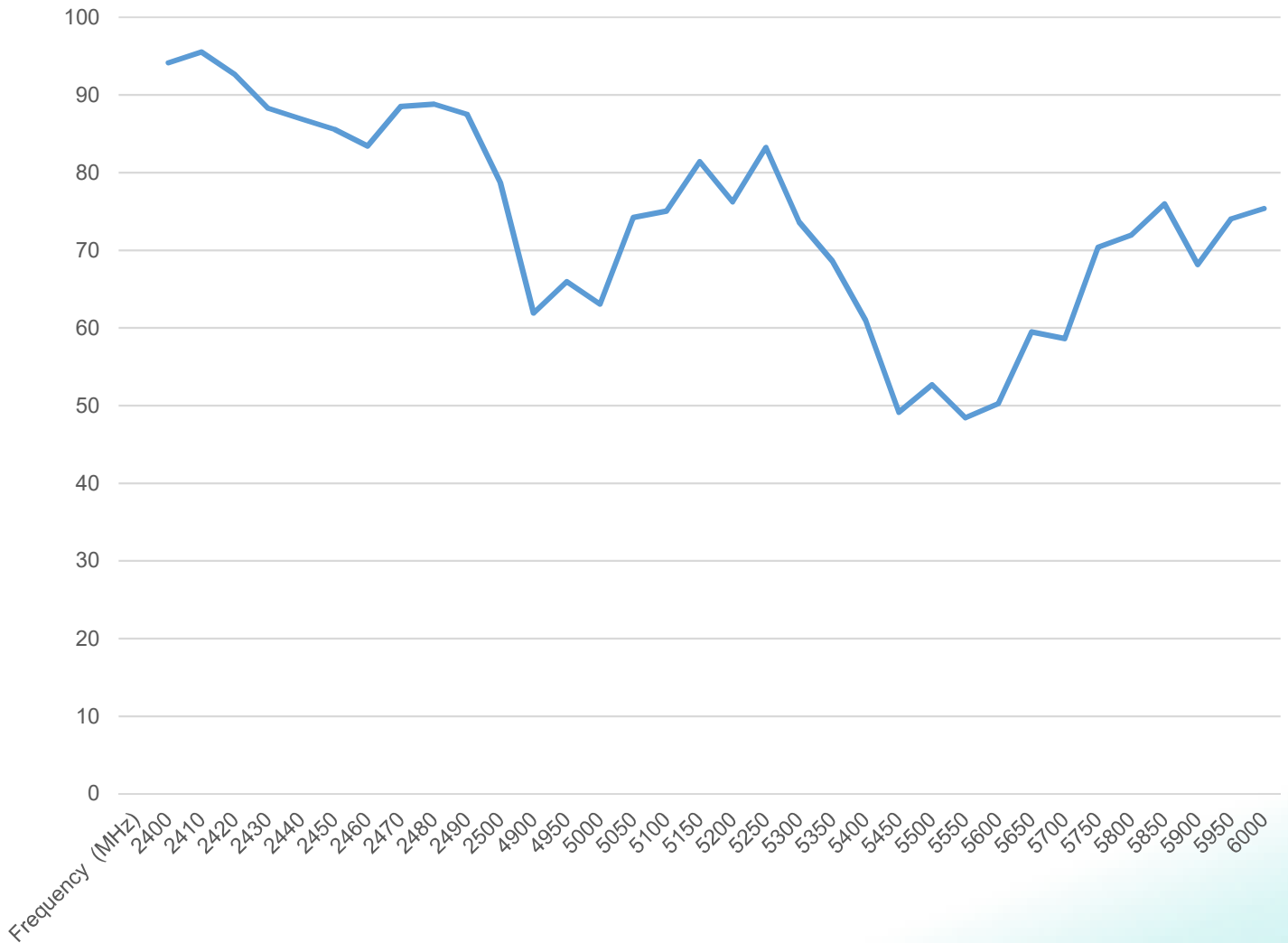

Issue: 1743

In the effort to improve our products, we reserve the right to make changes judged to be necessary.

CONFIDENTIAL AND PROPRIETARY INFORMATION

This document contains confidential and proprietary information of Pulse Electronics, Inc. (Pulse) and is protected by copyright, trade secret and other state and federal laws. Its receipt or possession does not convey any rights to reproduce, disclose its contents, or to manufacture, use or sell anything it may describe. Reproduction, disclosure or use without specific written authorization of Pulse is strictly forbidden.



Description: LOW PROFILE MULTIBAND ANTENNA

Series: IceFin

PART NUMBER: ICEFINXXX

CHARTS

Efficiency(%)

ICEFIN24DMN
Efficiency (%)

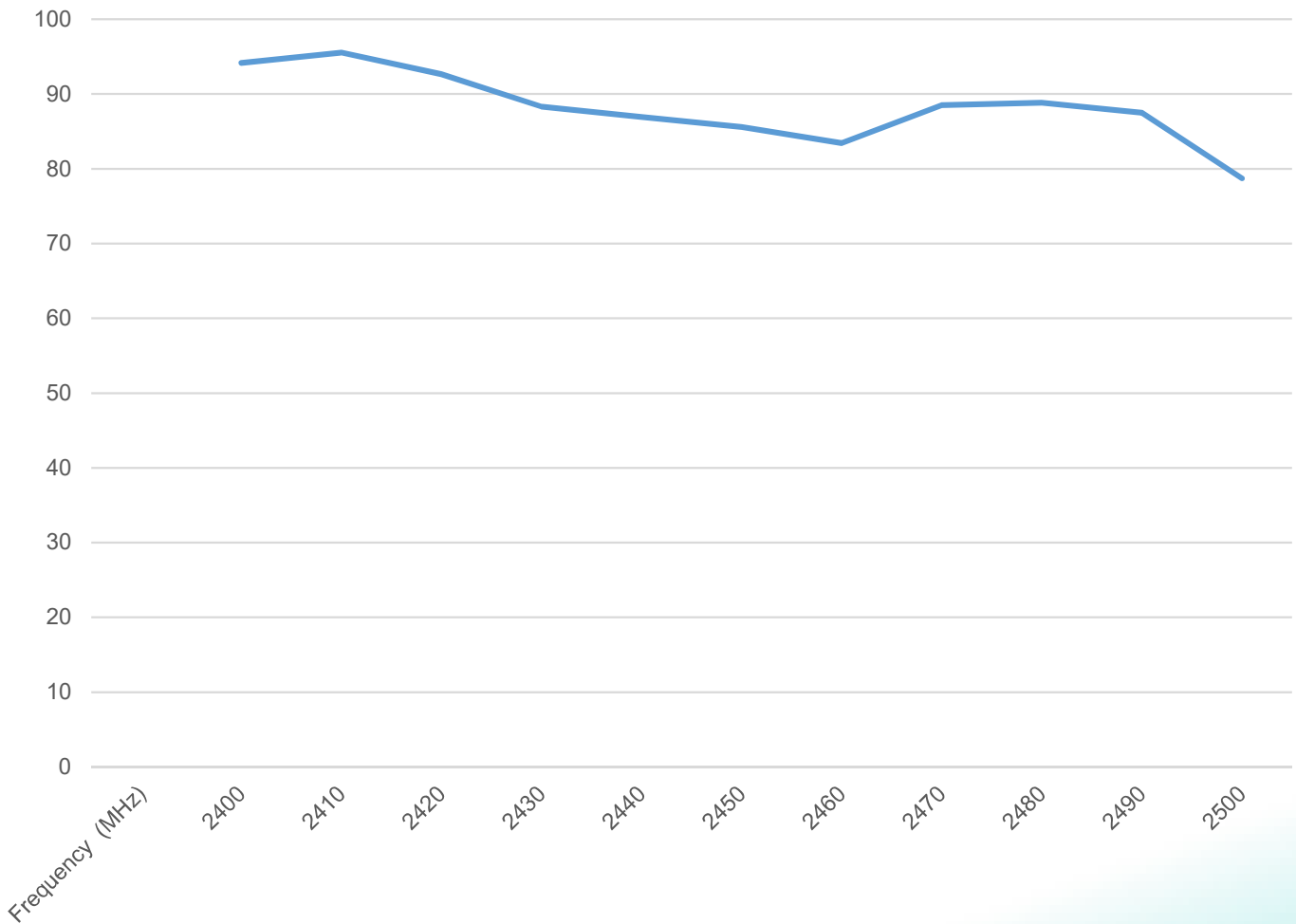

Issue: 1743

In the effort to improve our products, we reserve the right to make changes judged to be necessary.

CONFIDENTIAL AND PROPRIETARY INFORMATION

This document contains confidential and proprietary information of Pulse Electronics, Inc. (Pulse) and is protected by copyright, trade secret and other state and federal laws. Its receipt or possession does not convey any rights to reproduce, disclose its contents, or to manufacture, use or sell anything it may describe. Reproduction, disclosure or use without specific written authorization of Pulse is strictly forbidden.



Description: LOW PROFILE MULTIBAND ANTENNA

Series: IceFin

PART NUMBER: ICEFINXXX

CHARTS

Efficiency(%)

ICEFIN49DMN
Efficiency (%)

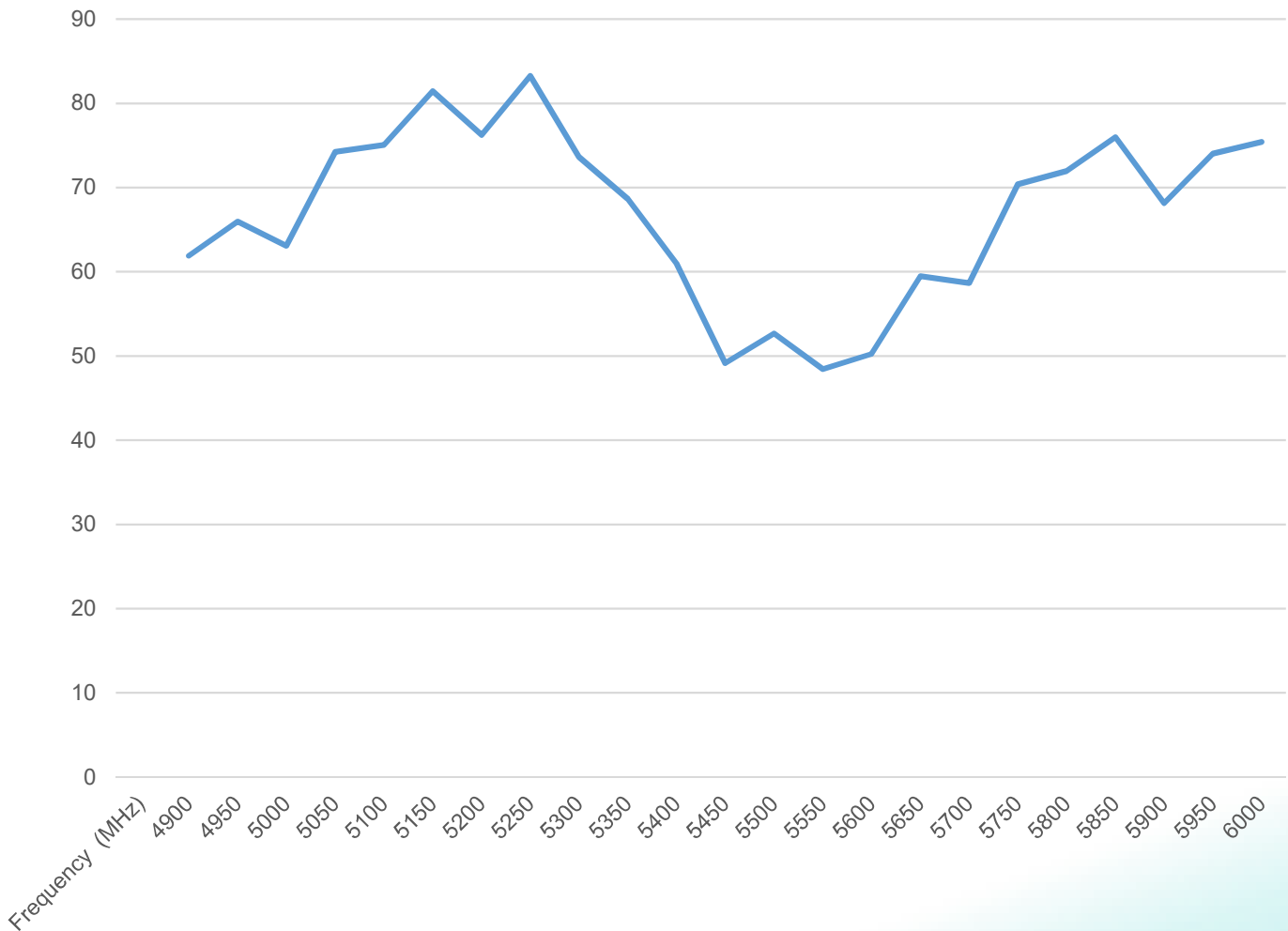

Issue: 1743

In the effort to improve our products, we reserve the right to make changes judged to be necessary.

CONFIDENTIAL AND PROPRIETARY INFORMATION

This document contains confidential and proprietary information of Pulse Electronics, Inc. (Pulse) and is protected by copyright, trade secret and other state and federal laws. Its receipt or possession does not convey any rights to reproduce, disclose its contents, or to manufacture, use or sell anything it may describe. Reproduction, disclosure or use without specific written authorization of Pulse is strictly forbidden.



Description: LOW PROFILE MULTIBAND ANTENNA

Series: IceFin

PART NUMBER: ICEFINXXX

CHARTS

Efficiency(%)

ICEFINWDMN
Efficiency (%)

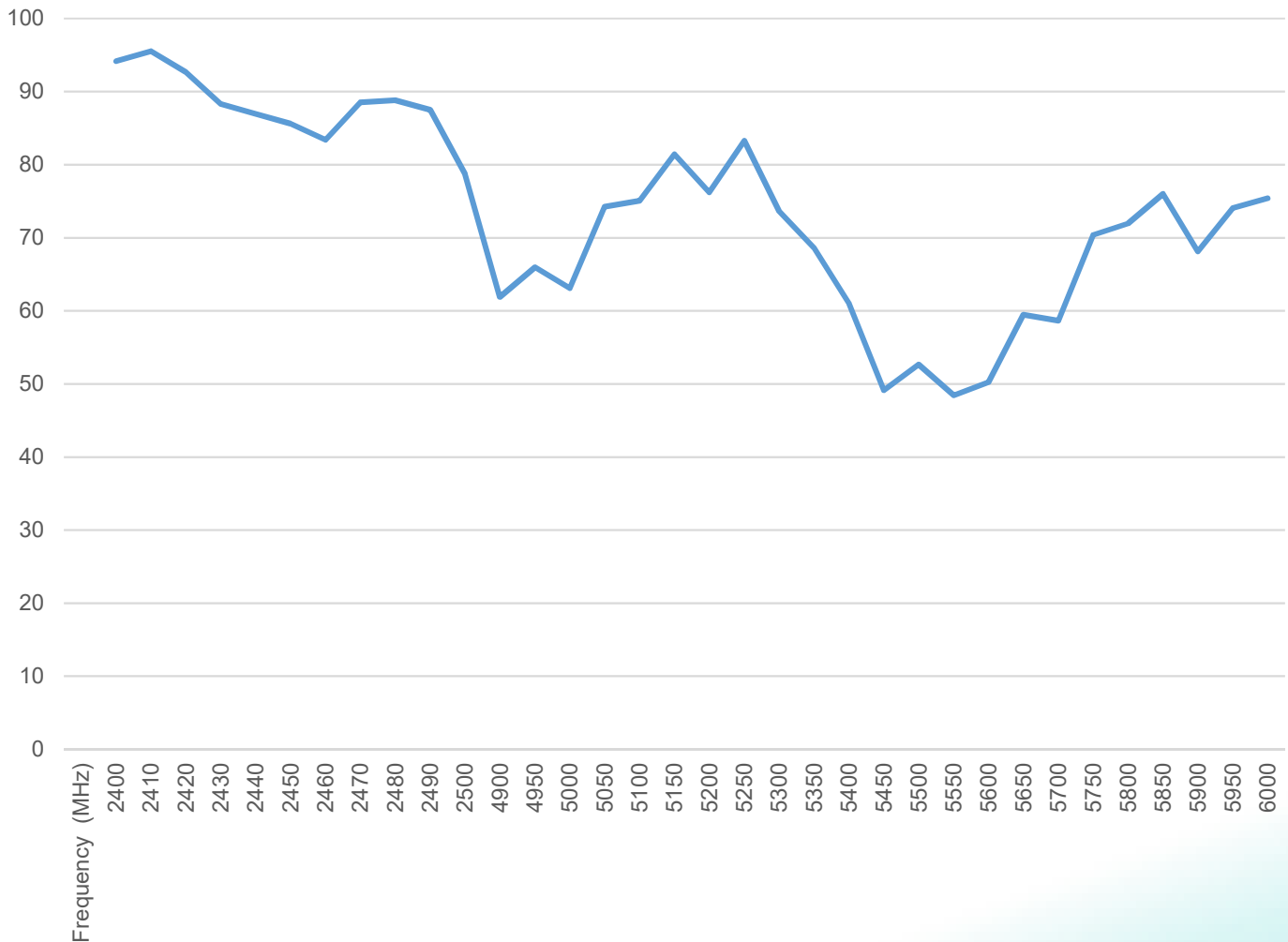

Issue: 1743

In the effort to improve our products, we reserve the right to make changes judged to be necessary.

CONFIDENTIAL AND PROPRIETARY INFORMATION

This document contains confidential and proprietary information of Pulse Electronics, Inc. (Pulse) and is protected by copyright, trade secret and other state and federal laws. Its receipt or possession does not convey any rights to reproduce, disclose its contents, or to manufacture, use or sell anything it may describe. Reproduction, disclosure or use without specific written authorization of Pulse is strictly forbidden.



Description: LOW PROFILE MULTIBAND ANTENNA

Series: IceFin

PART NUMBER: ICEFINXXX

CHARTS

Peak Gain (dBi)

ICEFINLNMOHF
Peak Gain(dBi)

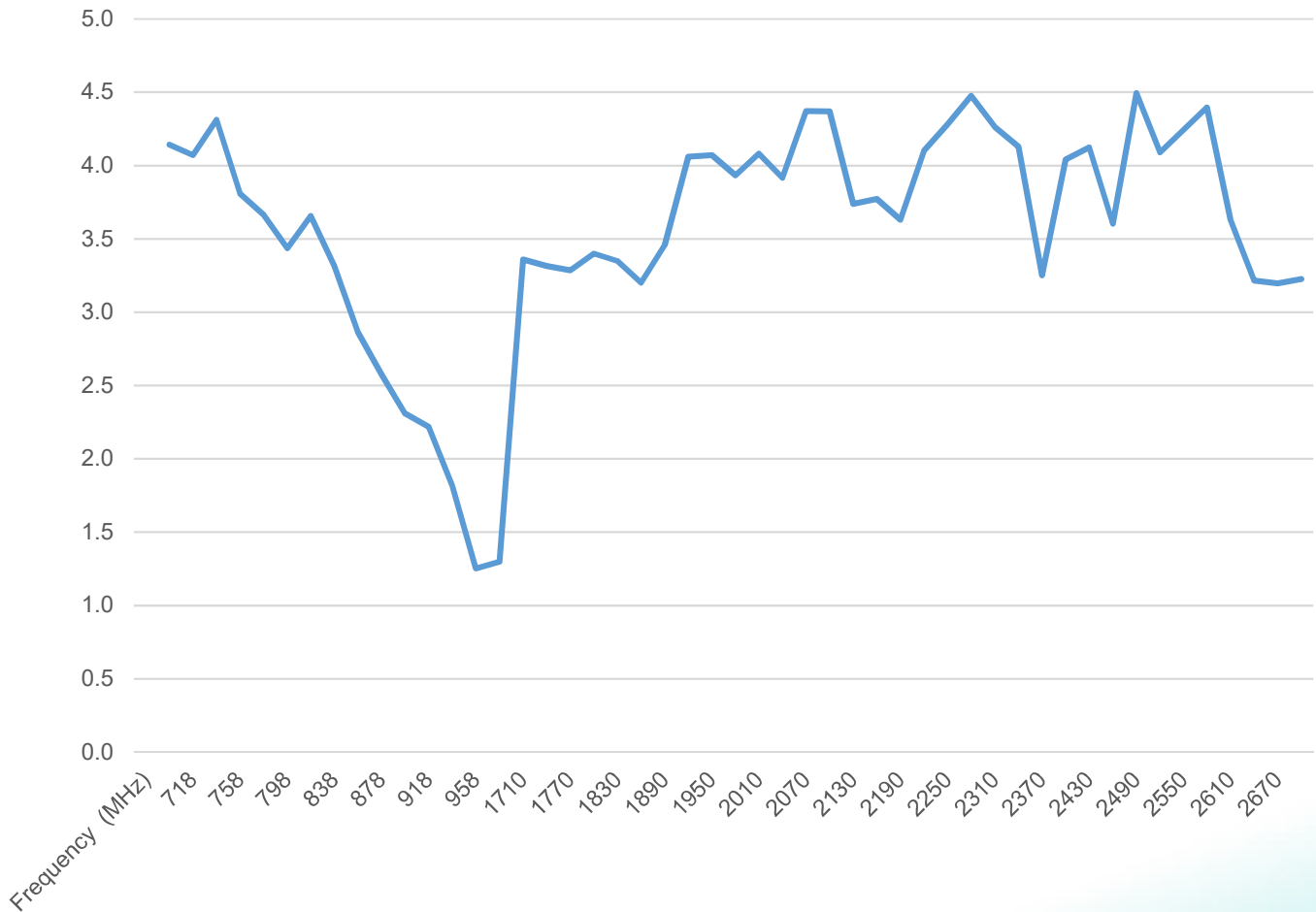

Issue: 1743

In the effort to improve our products, we reserve the right to make changes judged to be necessary.

CONFIDENTIAL AND PROPRIETARY INFORMATION

This document contains confidential and proprietary information of Pulse Electronics, Inc. (Pulse) and is protected by copyright, trade secret and other state and federal laws. Its receipt or possession does not convey any rights to reproduce, disclose its contents, or to manufacture, use or sell anything it may describe. Reproduction, disclosure or use without specific written authorization of Pulse is strictly forbidden.



Description: LOW PROFILE MULTIBAND ANTENNA

Series: IceFin

PART NUMBER: ICEFINXXX

CHARTS

Peak Gain (dBi)

ICEFIN698/960NMO
Peak Gain(dBi)

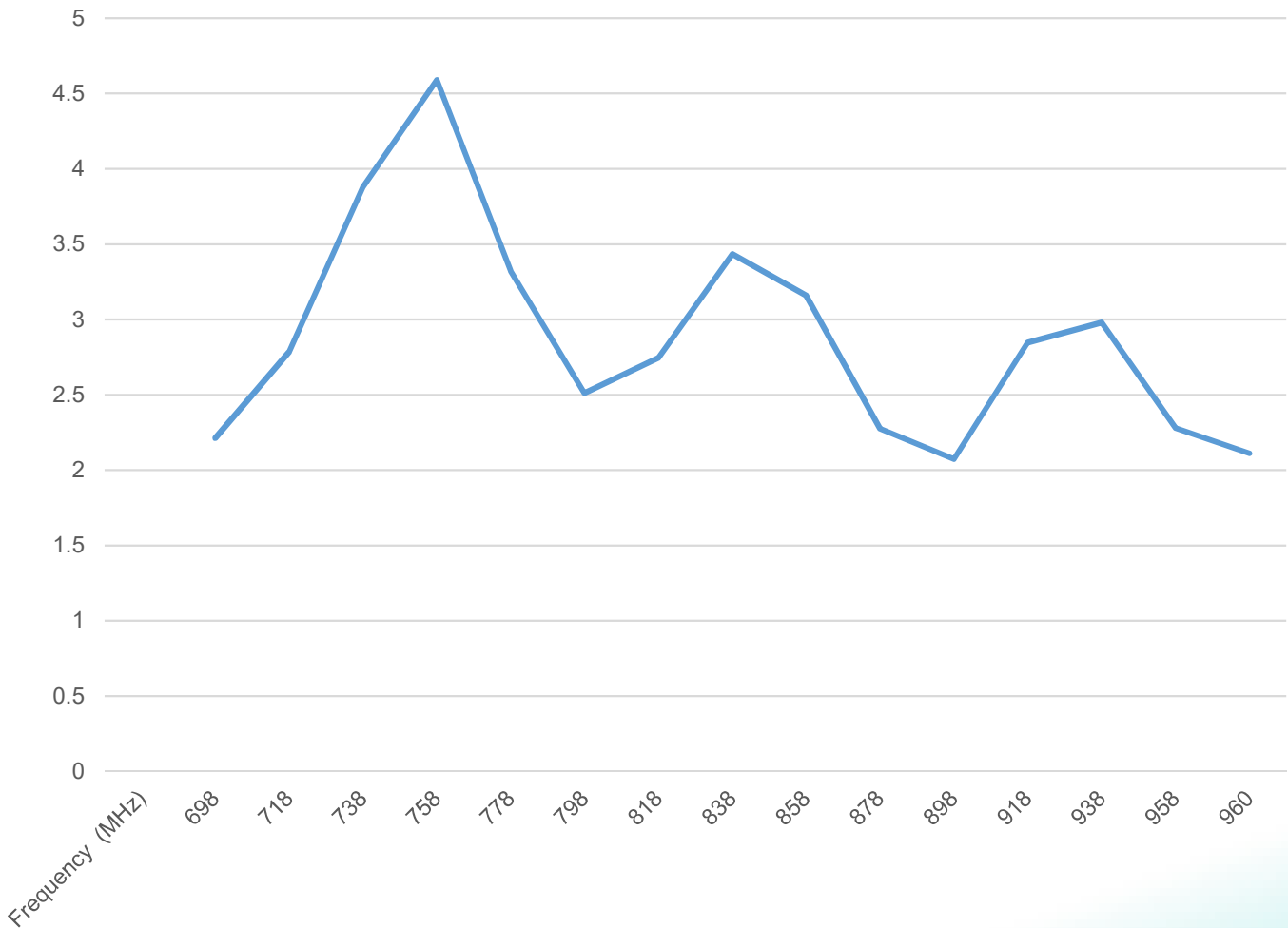

Issue: 1743

In the effort to improve our products, we reserve the right to make changes judged to be necessary.

CONFIDENTIAL AND PROPRIETARY INFORMATION

This document contains confidential and proprietary information of Pulse Electronics, Inc. (Pulse) and is protected by copyright, trade secret and other state and federal laws. Its receipt or possession does not convey any rights to reproduce, disclose its contents, or to manufacture, use or sell anything it may describe. Reproduction, disclosure or use without specific written authorization of Pulse is strictly forbidden.



Description: LOW PROFILE MULTIBAND ANTENNA

Series: IceFin

PART NUMBER: ICEFINXXX

CHARTS

Peak Gain (dBi)

ICEFIN806NMO
Peak Gain(dBi)

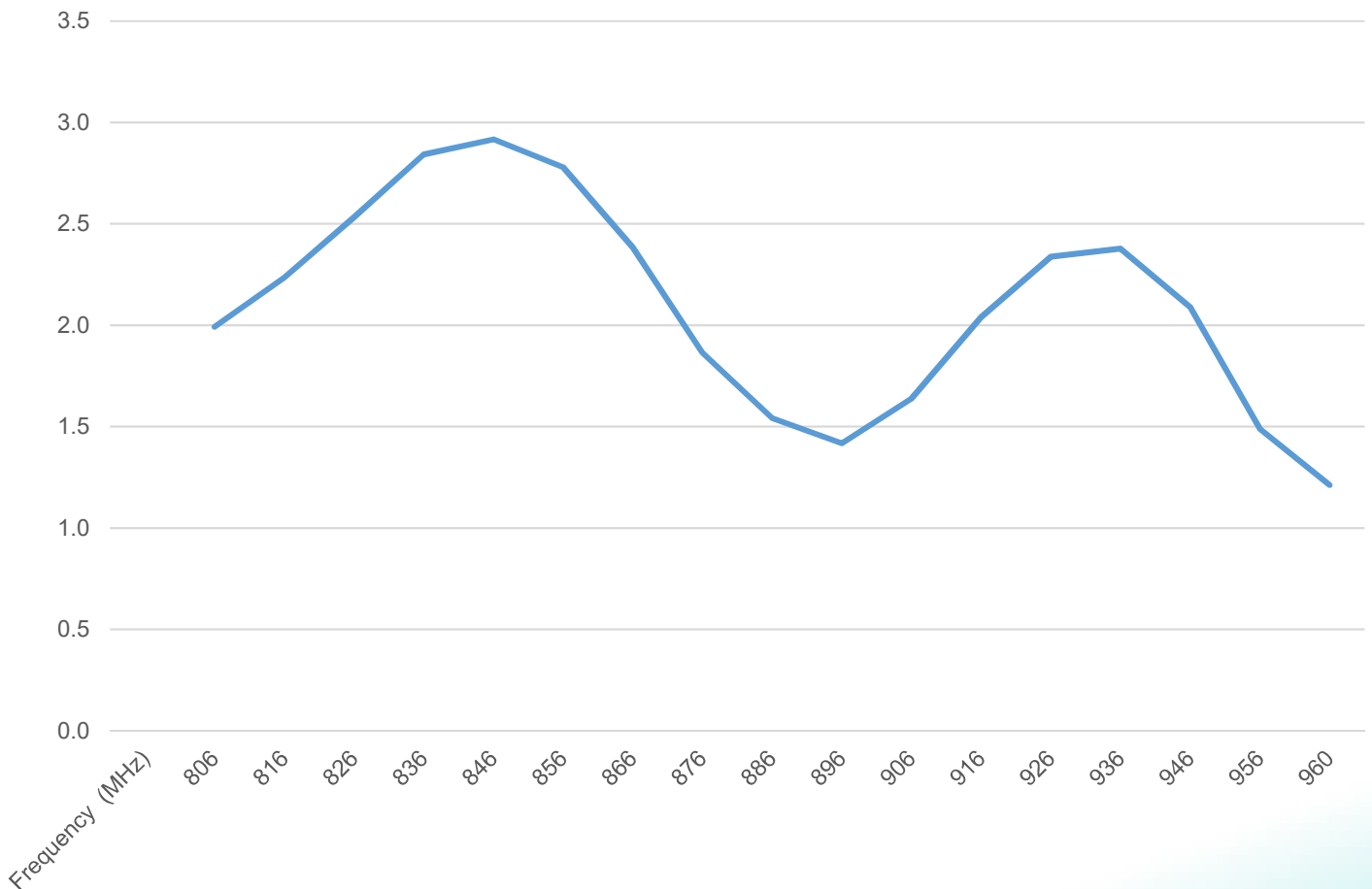

Issue: 1743

In the effort to improve our products, we reserve the right to make changes judged to be necessary.

CONFIDENTIAL AND PROPRIETARY INFORMATION

This document contains confidential and proprietary information of Pulse Electronics, Inc. (Pulse) and is protected by copyright, trade secret and other state and federal laws. Its receipt or possession does not convey any rights to reproduce, disclose its contents, or to manufacture, use or sell anything it may describe. Reproduction, disclosure or use without specific written authorization of Pulse is strictly forbidden.



Description: LOW PROFILE MULTIBAND ANTENNA

Series: IceFin

PART NUMBER: ICEFINXXX

CHARTS

Peak Gain (dBi)

ICEFIN698/869DMN
Peak Gain(dBi)

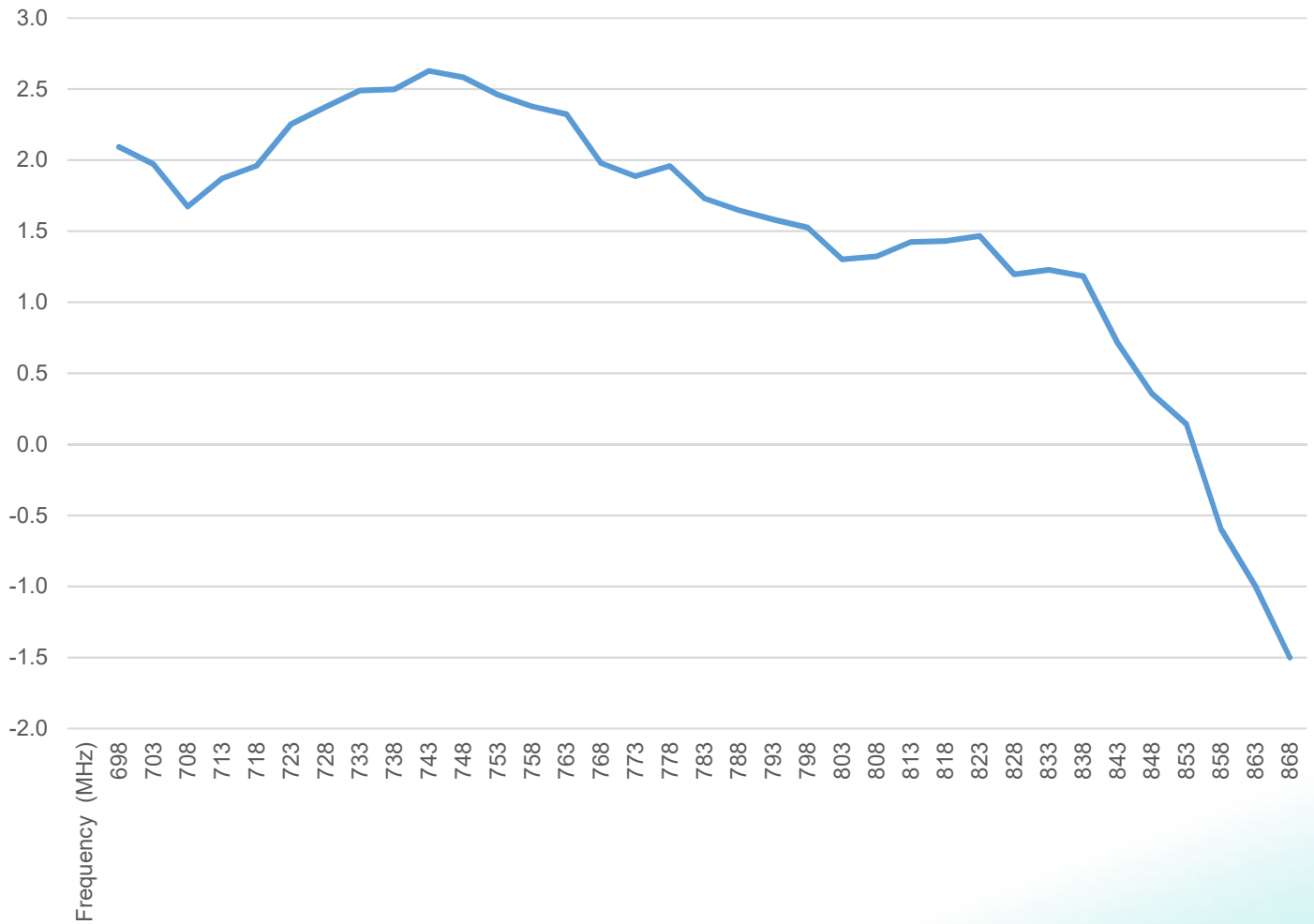

Issue: 1743

In the effort to improve our products, we reserve the right to make changes judged to be necessary.

CONFIDENTIAL AND PROPRIETARY INFORMATION

This document contains confidential and proprietary information of Pulse Electronics, Inc. (Pulse) and is protected by copyright, trade secret and other state and federal laws. Its receipt or possession does not convey any rights to reproduce, disclose its contents, or to manufacture, use or sell anything it may describe. Reproduction, disclosure or use without specific written authorization of Pulse is strictly forbidden.



Description: LOW PROFILE MULTIBAND ANTENNA

Series: IceFin

PART NUMBER: ICEFINXXX

CHARTS

Peak Gain (dBi)

ICEFIN806DMN
Peak Gain(dBi)

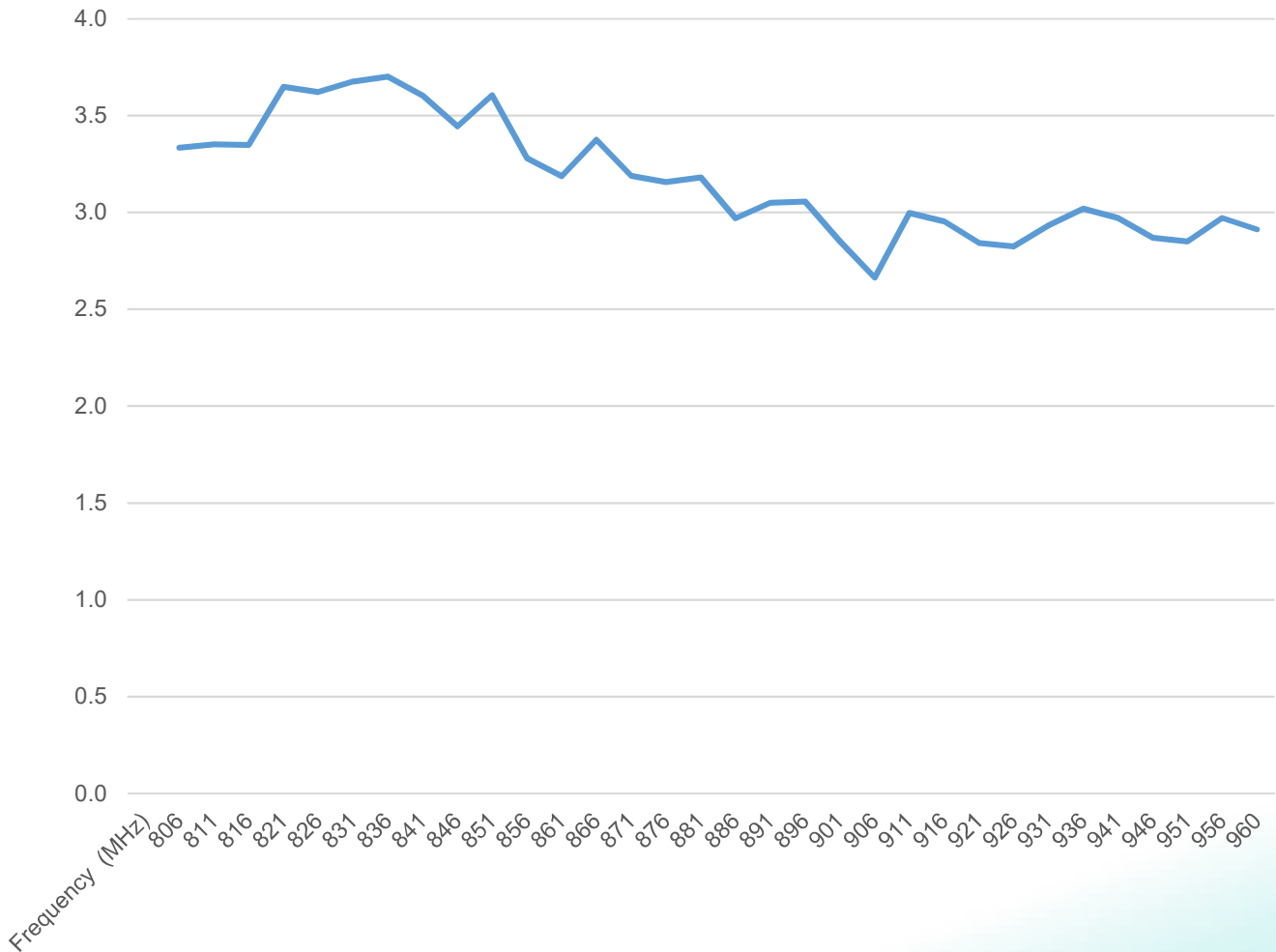

Issue: 1743

In the effort to improve our products, we reserve the right to make changes judged to be necessary.

CONFIDENTIAL AND PROPRIETARY INFORMATION

This document contains confidential and proprietary information of Pulse Electronics, Inc. (Pulse) and is protected by copyright, trade secret and other state and federal laws. Its receipt or possession does not convey any rights to reproduce, disclose its contents, or to manufacture, use or sell anything it may describe. Reproduction, disclosure or use without specific written authorization of Pulse is strictly forbidden.



Description: LOW PROFILE MULTIBAND ANTENNA

Series: IceFin

PART NUMBER: ICEFINXXX

CHARTS

Peak Gain (dBi)

ICEFINLDMN
Peak Gain(dBi)

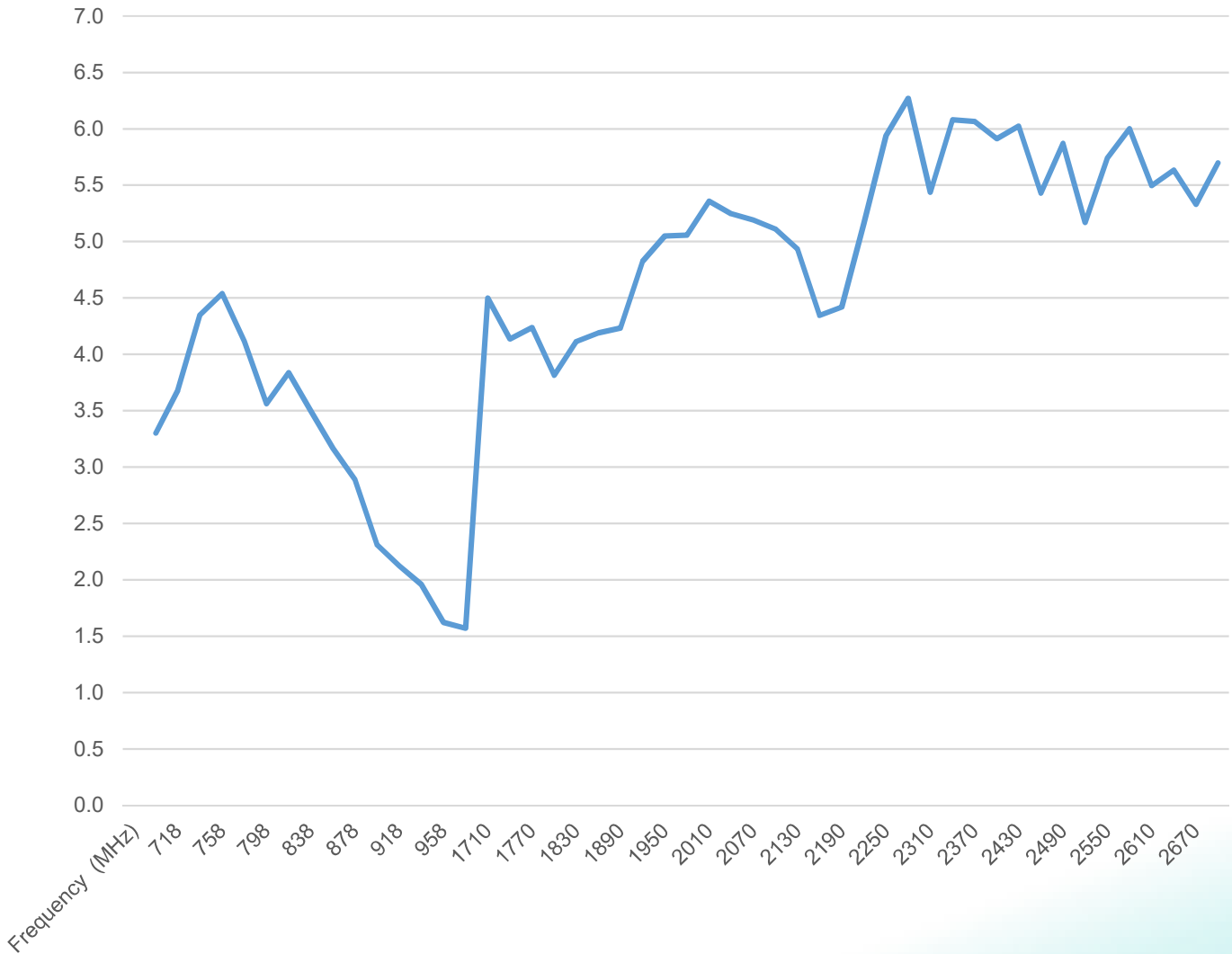

Issue: 1743

In the effort to improve our products, we reserve the right to make changes judged to be necessary.

CONFIDENTIAL AND PROPRIETARY INFORMATION

This document contains confidential and proprietary information of Pulse Electronics, Inc. (Pulse) and is protected by copyright, trade secret and other state and federal laws. Its receipt or possession does not convey any rights to reproduce, disclose its contents, or to manufacture, use or sell anything it may describe. Reproduction, disclosure or use without specific written authorization of Pulse is strictly forbidden.



Description: LOW PROFILE MULTIBAND ANTENNA

Series: IceFin

PART NUMBER: ICEFINXXX

CHARTS

Peak Gain (dBi)

ICEFIN24NMOHF
Peak Gain(dBi)

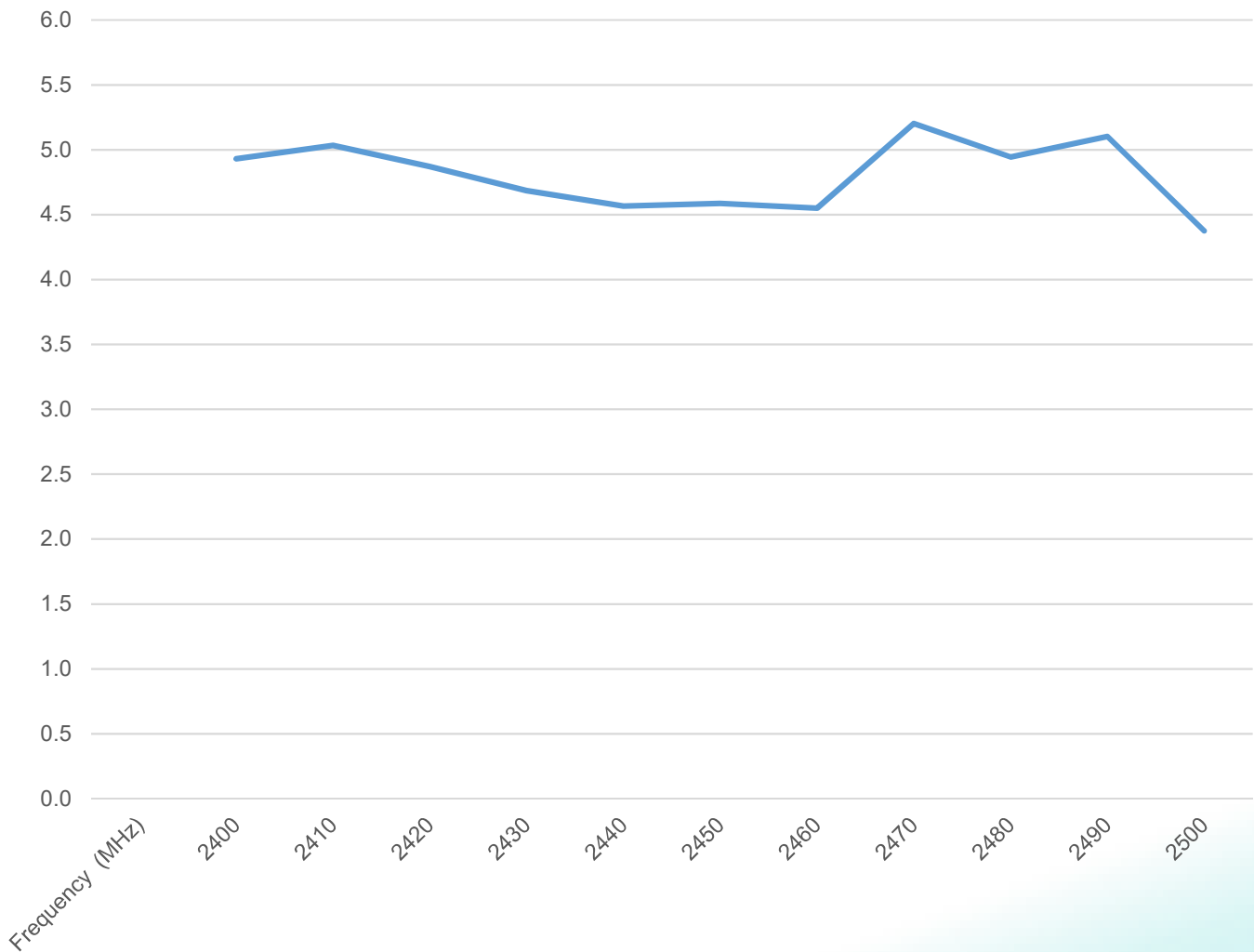

Issue: 1743

In the effort to improve our products, we reserve the right to make changes judged to be necessary.

CONFIDENTIAL AND PROPRIETARY INFORMATION

This document contains confidential and proprietary information of Pulse Electronics, Inc. (Pulse) and is protected by copyright, trade secret and other state and federal laws. Its receipt or possession does not convey any rights to reproduce, disclose its contents, or to manufacture, use or sell anything it may describe. Reproduction, disclosure or use without specific written authorization of Pulse is strictly forbidden.



Description: LOW PROFILE MULTIBAND ANTENNA

Series: IceFin

PART NUMBER: ICEFINXXX

CHARTS

Peak Gain (dBi)

ICEFIN49NMOHF
Peak Gain(dBi)

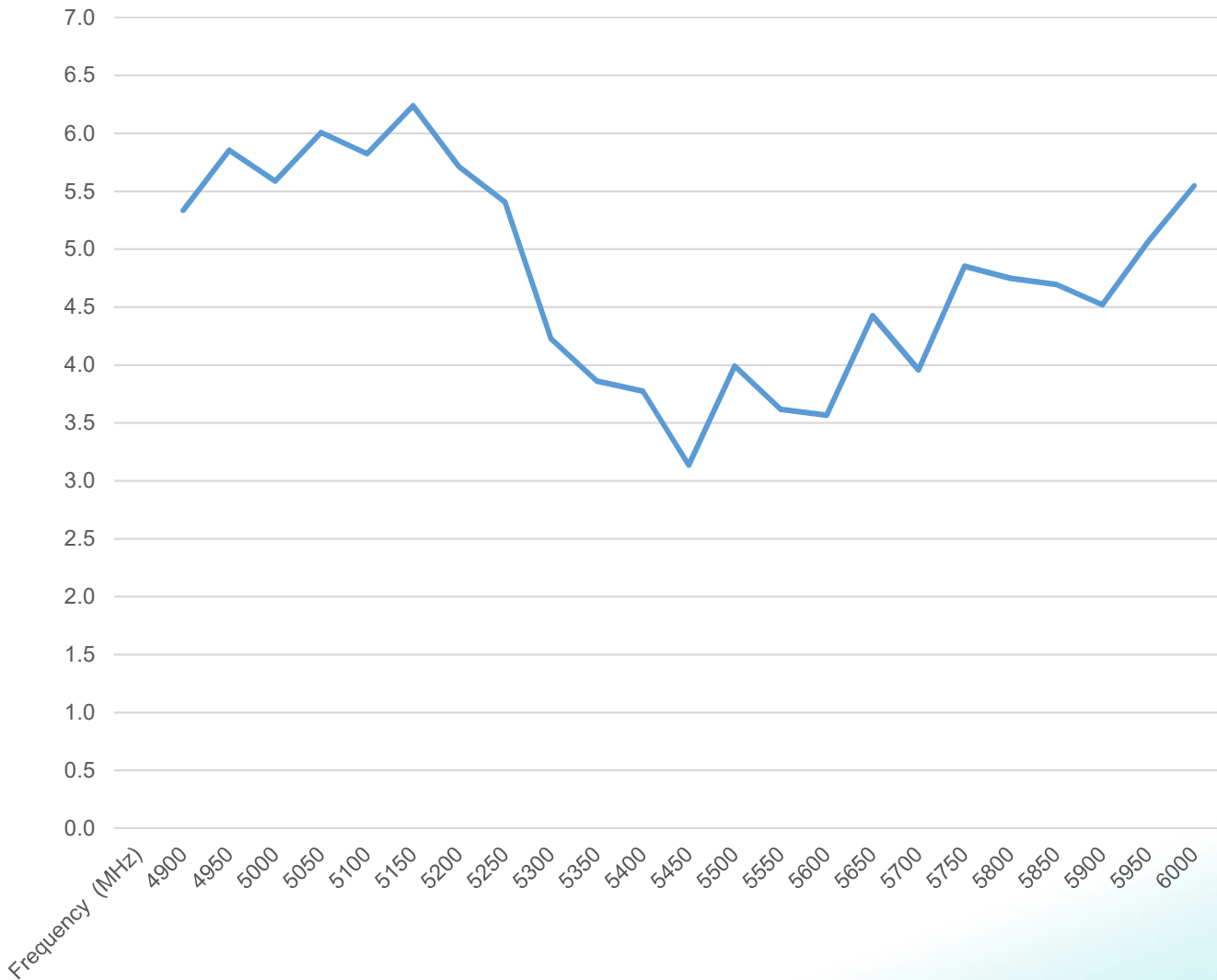

Issue: 1743

In the effort to improve our products, we reserve the right to make changes judged to be necessary.

CONFIDENTIAL AND PROPRIETARY INFORMATION

This document contains confidential and proprietary information of Pulse Electronics, Inc. (Pulse) and is protected by copyright, trade secret and other state and federal laws. Its receipt or possession does not convey any rights to reproduce, disclose its contents, or to manufacture, use or sell anything it may describe. Reproduction, disclosure or use without specific written authorization of Pulse is strictly forbidden.



Description: LOW PROFILE MULTIBAND ANTENNA

Series: IceFin

PART NUMBER: ICEFINXXX

CHARTS

Peak Gain (dBi)

ICEFINWNMOHF
Peak Gain(dBi)

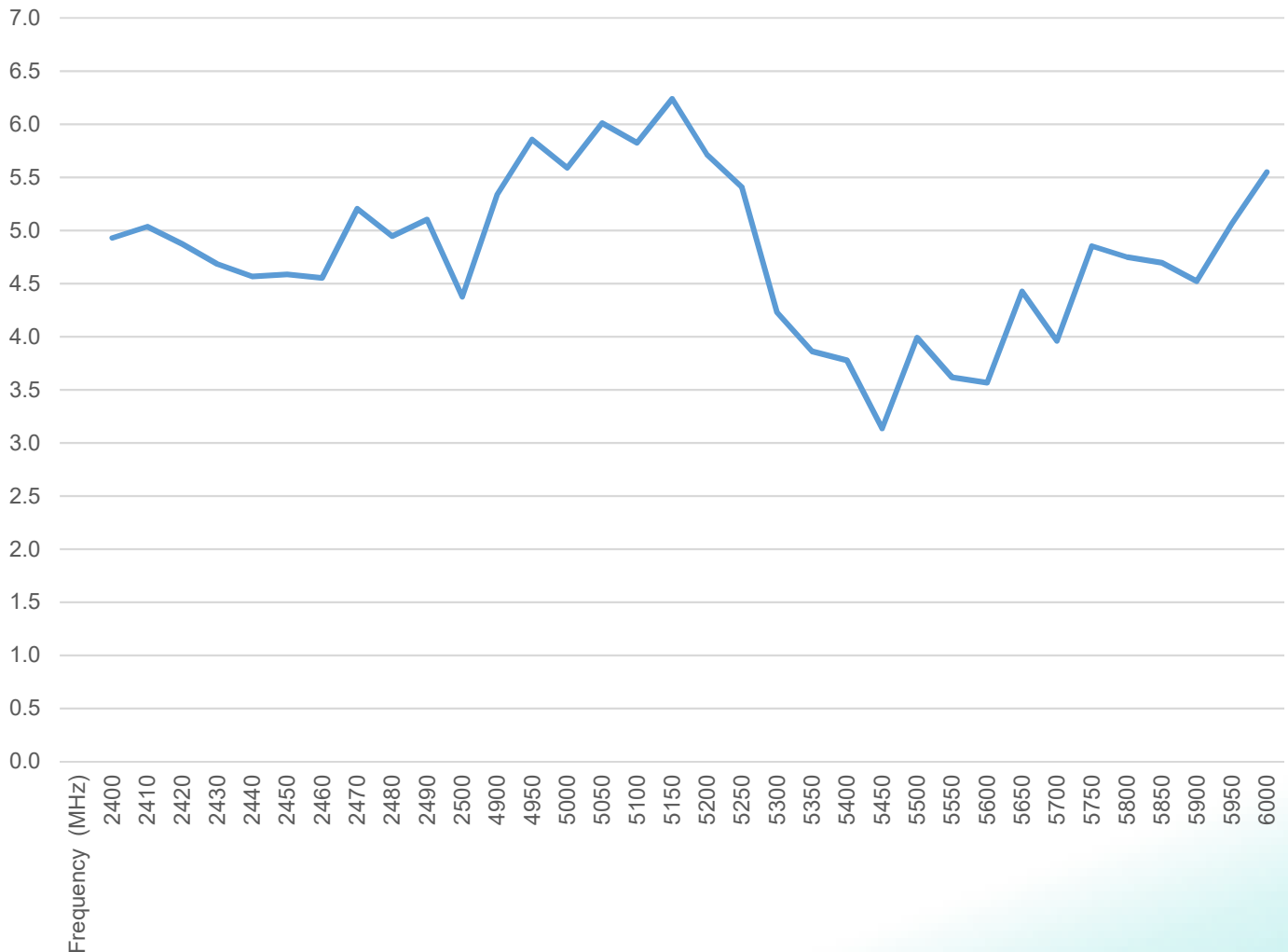

Issue: 1743

In the effort to improve our products, we reserve the right to make changes judged to be necessary.

CONFIDENTIAL AND PROPRIETARY INFORMATION

This document contains confidential and proprietary information of Pulse Electronics, Inc. (Pulse) and is protected by copyright, trade secret and other state and federal laws. Its receipt or possession does not convey any rights to reproduce, disclose its contents, or to manufacture, use or sell anything it may describe. Reproduction, disclosure or use without specific written authorization of Pulse is strictly forbidden.



Description: LOW PROFILE MULTIBAND ANTENNA

Series: IceFin

PART NUMBER: ICEFINXXX

CHARTS

Peak Gain (dBi)

ICEFIN24DMN
Peak Gain(dBi)

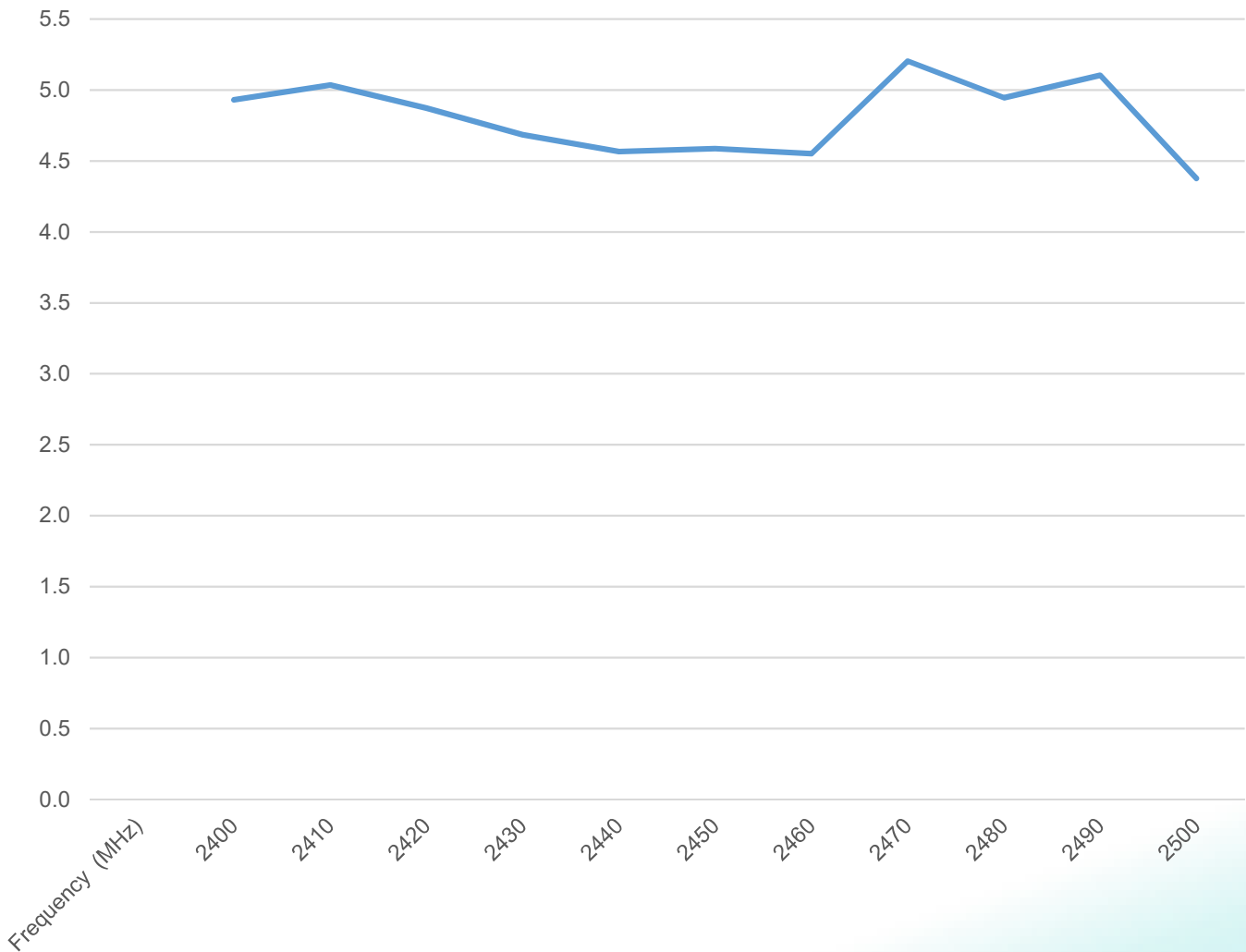

Issue: 1743

In the effort to improve our products, we reserve the right to make changes judged to be necessary.

CONFIDENTIAL AND PROPRIETARY INFORMATION

This document contains confidential and proprietary information of Pulse Electronics, Inc. (Pulse) and is protected by copyright, trade secret and other state and federal laws. Its receipt or possession does not convey any rights to reproduce, disclose its contents, or to manufacture, use or sell anything it may describe. Reproduction, disclosure or use without specific written authorization of Pulse is strictly forbidden.



Description: LOW PROFILE MULTIBAND ANTENNA

Series: IceFin

PART NUMBER: ICEFINXXX

CHARTS

Peak Gain (dBi)

ICEFIN49DMN
Peak Gain(dBi)

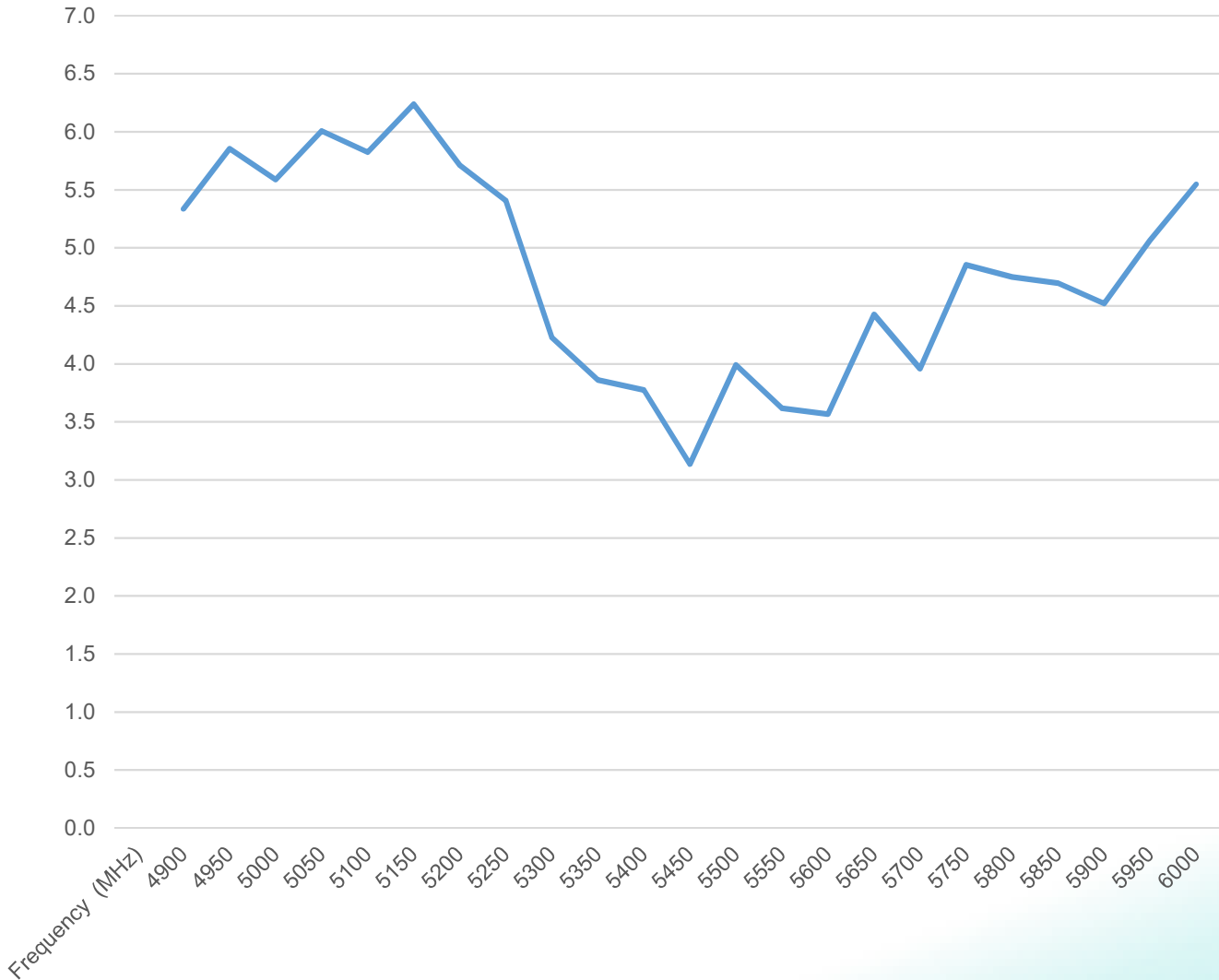

Issue: 1743

In the effort to improve our products, we reserve the right to make changes judged to be necessary.

CONFIDENTIAL AND PROPRIETARY INFORMATION

This document contains confidential and proprietary information of Pulse Electronics, Inc. (Pulse) and is protected by copyright, trade secret and other state and federal laws. Its receipt or possession does not convey any rights to reproduce, disclose its contents, or to manufacture, use or sell anything it may describe. Reproduction, disclosure or use without specific written authorization of Pulse is strictly forbidden.



Description: LOW PROFILE MULTIBAND ANTENNA

Series: IceFin

PART NUMBER: ICEFINXXX

CHARTS

Peak Gain (dBi)

ICEFINWDMN
Peak Gain(dBi)

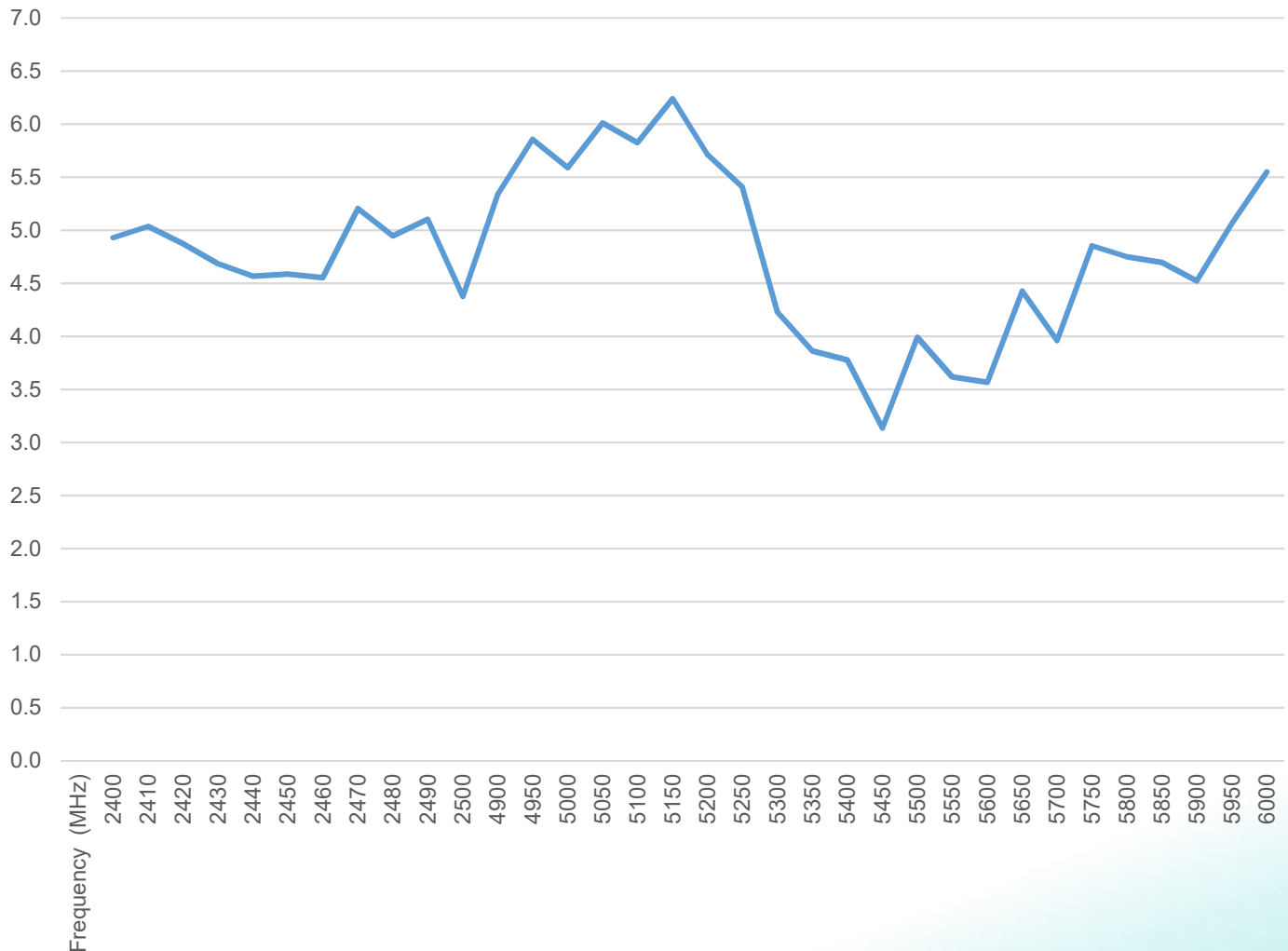

Issue: 1743

In the effort to improve our products, we reserve the right to make changes judged to be necessary.

CONFIDENTIAL AND PROPRIETARY INFORMATION

This document contains confidential and proprietary information of Pulse Electronics, Inc. (Pulse) and is protected by copyright, trade secret and other state and federal laws. Its receipt or possession does not convey any rights to reproduce, disclose its contents, or to manufacture, use or sell anything it may describe. Reproduction, disclosure or use without specific written authorization of Pulse is strictly forbidden.



Description: LOW PROFILE MULTIBAND ANTENNA

Series: IceFin

PART NUMBER: ICEFINXXX

CHARTS

Free Space Radiation Pattern

ICEFINLNMOHF

Elevation Plane

Horizontal Plane

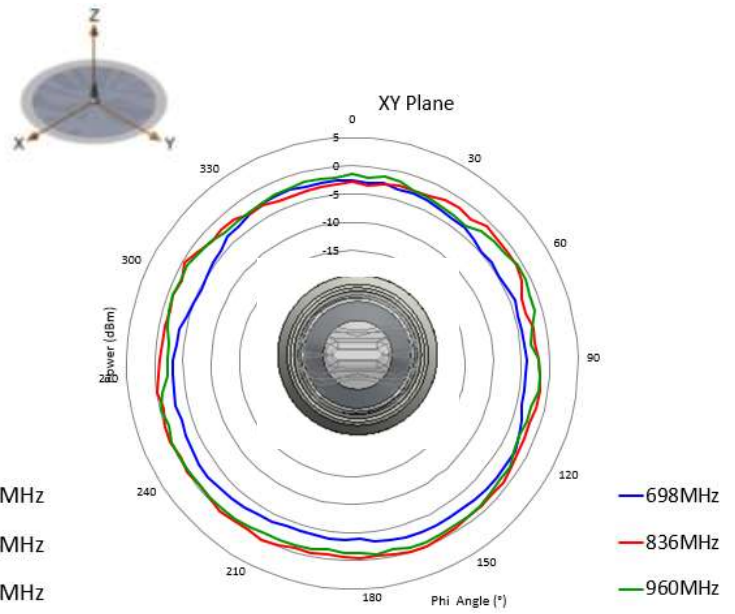
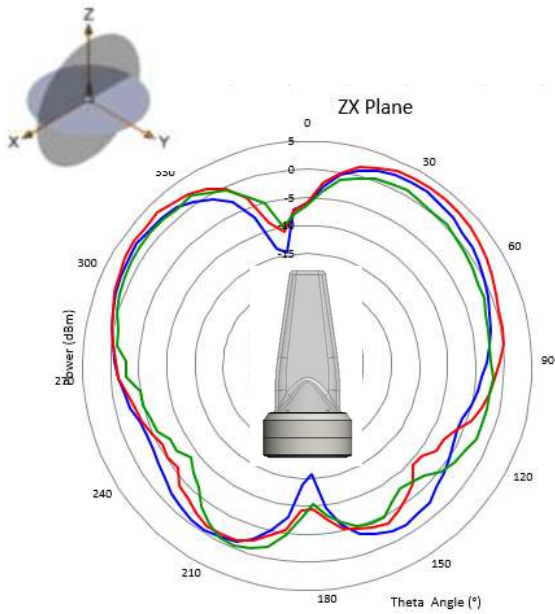

Issue: 1743

In the effort to improve our products, we reserve the right to make changes judged to be necessary.

CONFIDENTIAL AND PROPRIETARY INFORMATION

This document contains confidential and proprietary information of Pulse Electronics, Inc. (Pulse) and is protected by copyright, trade secret and other state and federal laws. Its receipt or possession does not convey any rights to reproduce, disclose its contents, or to manufacture, use or sell anything it may describe. Reproduction, disclosure or use without specific written authorization of Pulse is strictly forbidden.

Description: LOW PROFILE MULTIBAND ANTENNA

Series: IceFin

PART NUMBER: ICEFINXXX

CHARTS

Free Space Radiation Pattern

ICEFINLNMOHF

Elevation Plane

Horizontal Plane

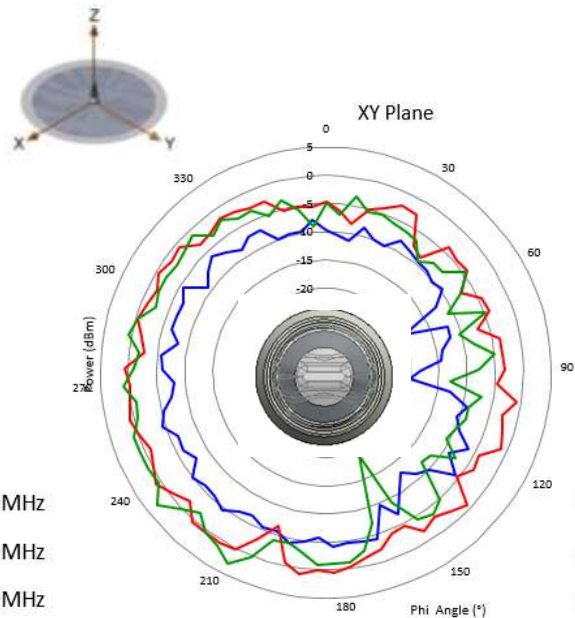
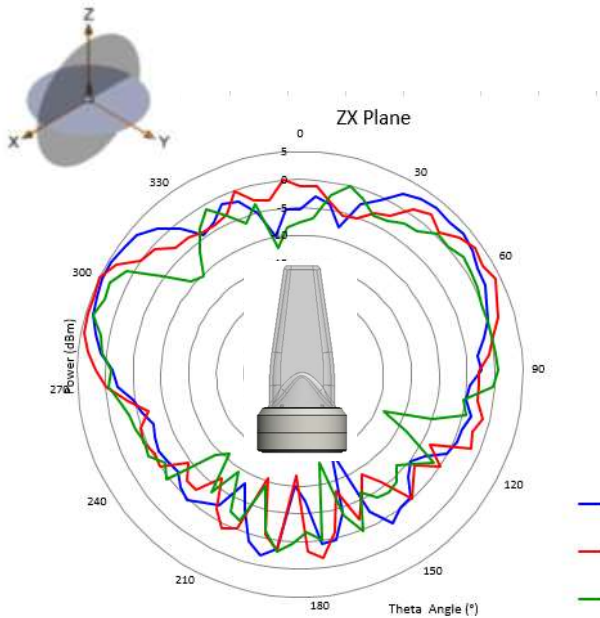

Issue: 1743

In the effort to improve our products, we reserve the right to make changes judged to be necessary.

CONFIDENTIAL AND PROPRIETARY INFORMATION

This document contains confidential and proprietary information of Pulse Electronics, Inc. (Pulse) and is protected by copyright, trade secret and other state and federal laws. Its receipt or possession does not convey any rights to reproduce, disclose its contents, or to manufacture, use or sell anything it may describe. Reproduction, disclosure or use without specific written authorization of Pulse is strictly forbidden.

Description: LOW PROFILE MULTIBAND ANTENNA

Series: IceFin

PART NUMBER: ICEFINXXX

CHARTS

Free Space Radiation Pattern

ICEFIN698/960NMO

Elevation Plane

Horizontal Plane

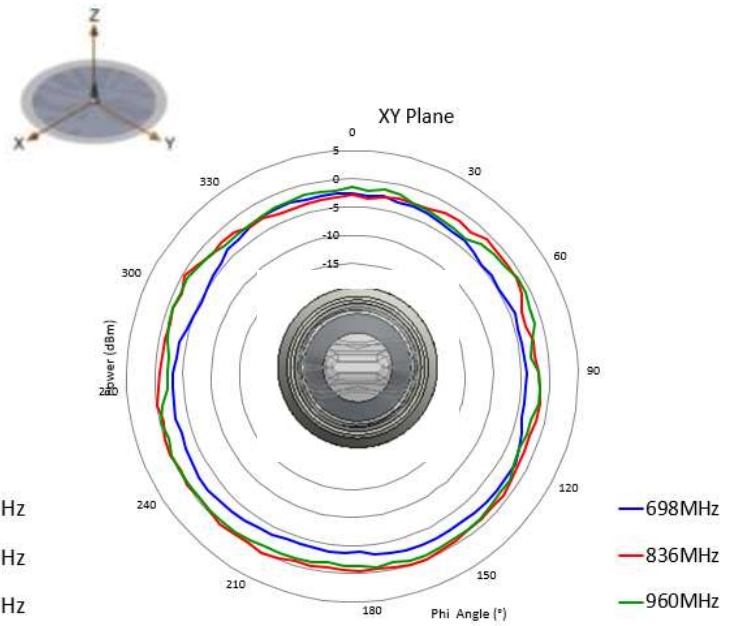
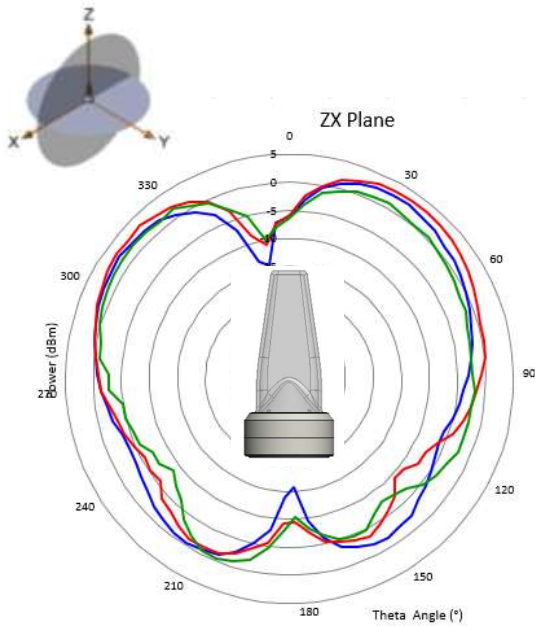

Issue: 1743

In the effort to improve our products, we reserve the right to make changes judged to be necessary.

CONFIDENTIAL AND PROPRIETARY INFORMATION

This document contains confidential and proprietary information of Pulse Electronics, Inc. (Pulse) and is protected by copyright, trade secret and other state and federal laws. Its receipt or possession does not convey any rights to reproduce, disclose its contents, or to manufacture, use or sell anything it may describe. Reproduction, disclosure or use without specific written authorization of Pulse is strictly forbidden.

Description: LOW PROFILE MULTIBAND ANTENNA

Series: IceFin

PART NUMBER: ICEFINXXX

CHARTS

Free Space Radiation Pattern

ICEFIN806NMO

Elevation Plane

Horizontal Plane

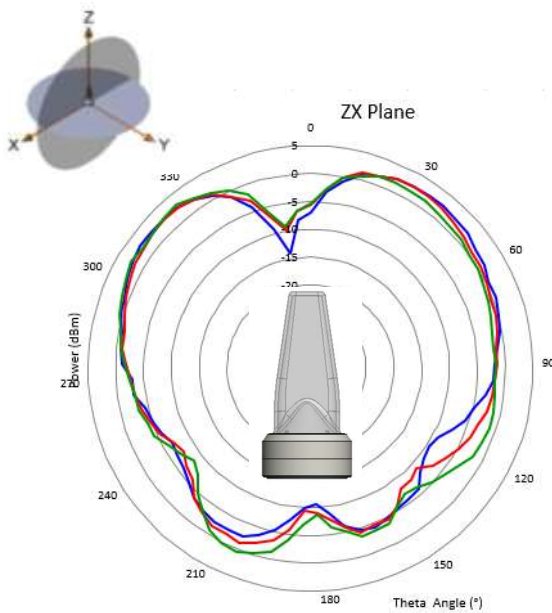

— 806MHz
— 889MHz
— 960MHz

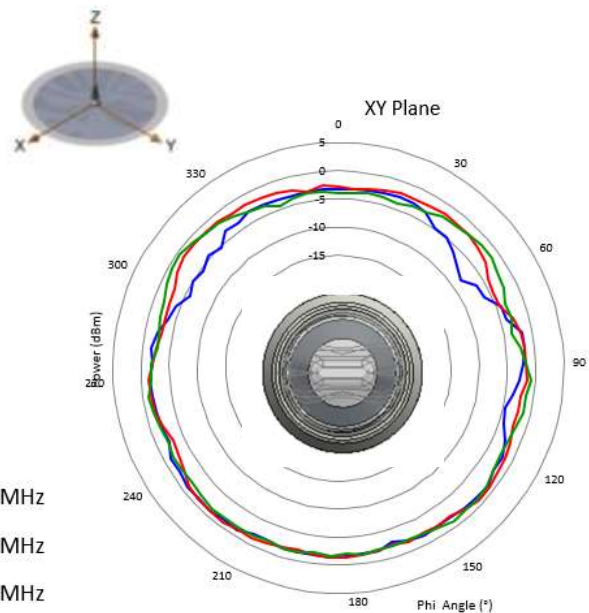

— 806MHz
— 885MHz
— 960MHz

Issue: 1743

In the effort to improve our products, we reserve the right to make changes judged to be necessary.

CONFIDENTIAL AND PROPRIETARY INFORMATION

This document contains confidential and proprietary information of Pulse Electronics, Inc. (Pulse) and is protected by copyright, trade secret and other state and federal laws. Its receipt or possession does not convey any rights to reproduce, disclose its contents, or to manufacture, use or sell anything it may describe. Reproduction, disclosure or use without specific written authorization of Pulse is strictly forbidden.

Description: LOW PROFILE MULTIBAND ANTENNA

Series: IceFin

PART NUMBER: ICEFINXXX

CHARTS

Free Space Radiation Pattern

ICEFIN698/869DMN

Elevation Plane

Horizontal Plane

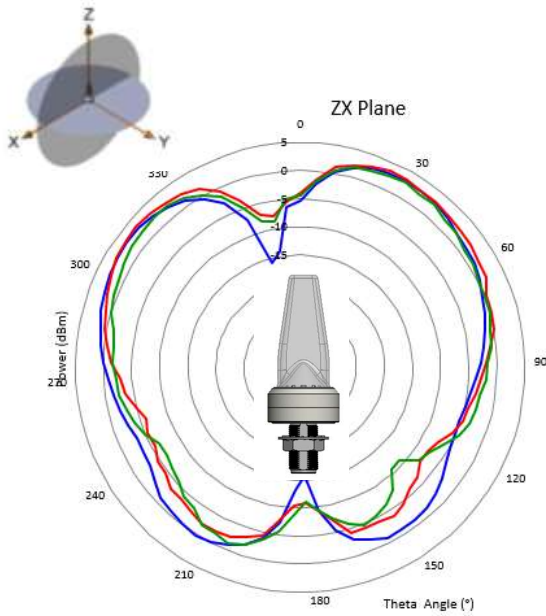

— 698MHz
— 784MHz
— 869MHz

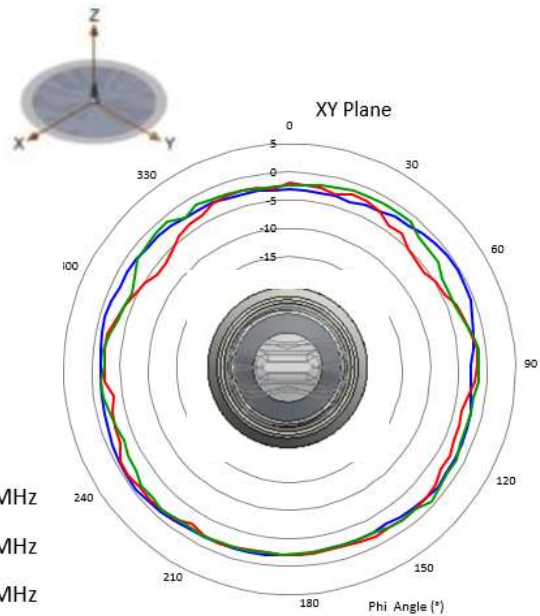

— 698MHz
— 784MHz
— 869MHz

Issue: 1743

In the effort to improve our products, we reserve the right to make changes judged to be necessary.

CONFIDENTIAL AND PROPRIETARY INFORMATION

This document contains confidential and proprietary information of Pulse Electronics, Inc. (Pulse) and is protected by copyright, trade secret and other state and federal laws. Its receipt or possession does not convey any rights to reproduce, disclose its contents, or to manufacture, use or sell anything it may describe. Reproduction, disclosure or use without specific written authorization of Pulse is strictly forbidden.

Description: LOW PROFILE MULTIBAND ANTENNA

Series: IceFin

PART NUMBER: ICEFINXXX

CHARTS

Free Space Radiation Pattern

ICEFIN806DMN

Elevation Plane

Horizontal Plane

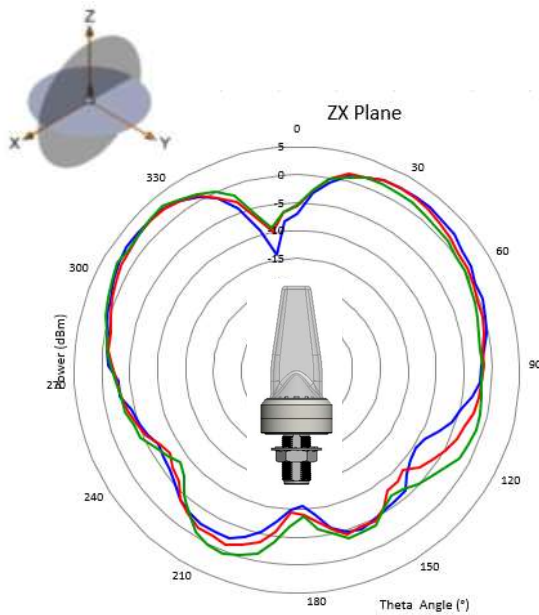

— 806MHz
— 889MHz
— 960MHz

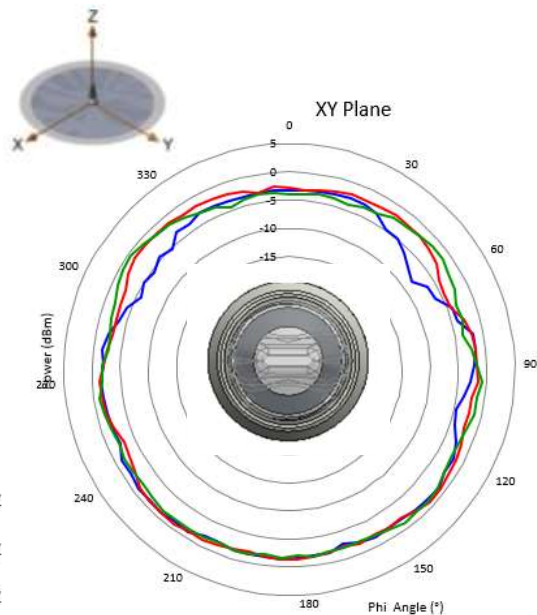

— 806MHz
— 885MHz
— 960MHz

Issue: 1743

In the effort to improve our products, we reserve the right to make changes judged to be necessary.

CONFIDENTIAL AND PROPRIETARY INFORMATION

This document contains confidential and proprietary information of Pulse Electronics, Inc. (Pulse) and is protected by copyright, trade secret and other state and federal laws. Its receipt or possession does not convey any rights to reproduce, disclose its contents, or to manufacture, use or sell anything it may describe. Reproduction, disclosure or use without specific written authorization of Pulse is strictly forbidden.

Description: LOW PROFILE MULTIBAND ANTENNA

Series: IceFin

PART NUMBER: ICEFINXXX

CHARTS

Free Space Radiation Pattern

ICEFINLDMN

Elevation Plane

Horizontal Plane

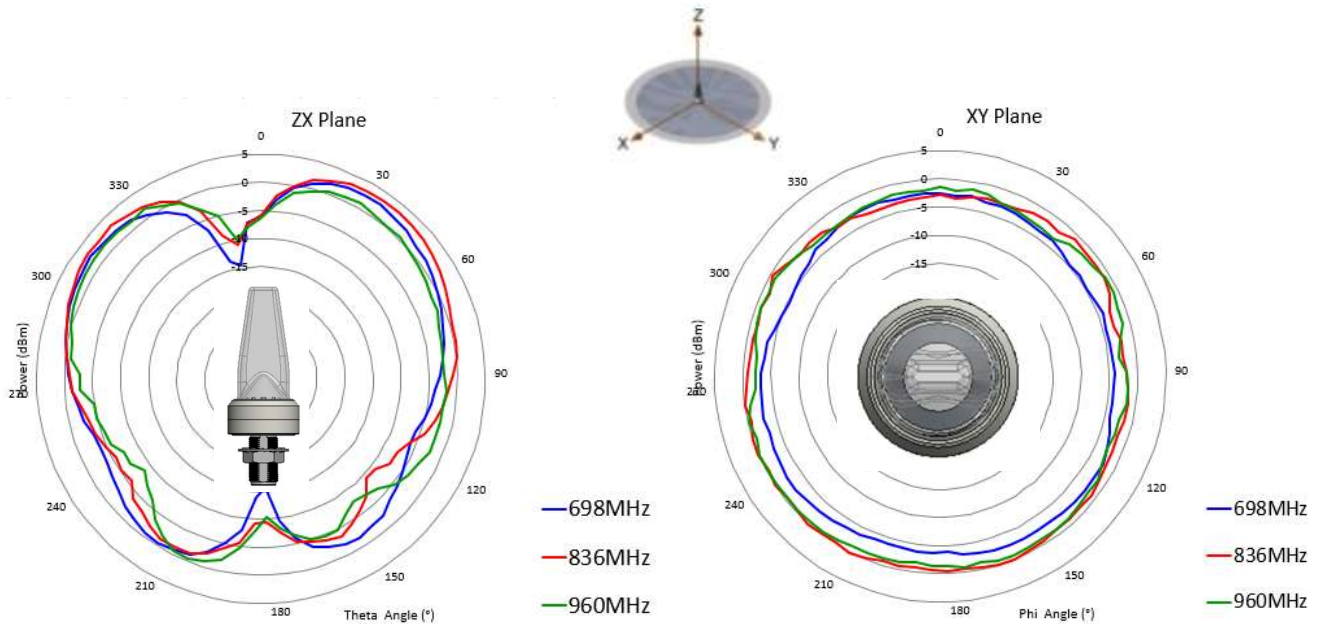

Issue: 1743

In the effort to improve our products, we reserve the right to make changes judged to be necessary.

CONFIDENTIAL AND PROPRIETARY INFORMATION

This document contains confidential and proprietary information of Pulse Electronics, Inc. (Pulse) and is protected by copyright, trade secret and other state and federal laws. Its receipt or possession does not convey any rights to reproduce, disclose its contents, or to manufacture, use or sell anything it may describe. Reproduction, disclosure or use without specific written authorization of Pulse is strictly forbidden.

Description: LOW PROFILE MULTIBAND ANTENNA

Series: IceFin

PART NUMBER: ICEFINXXX

CHARTS

Free Space Radiation Pattern

ICEFINLDMN

Elevation Plane

Horizontal Plane

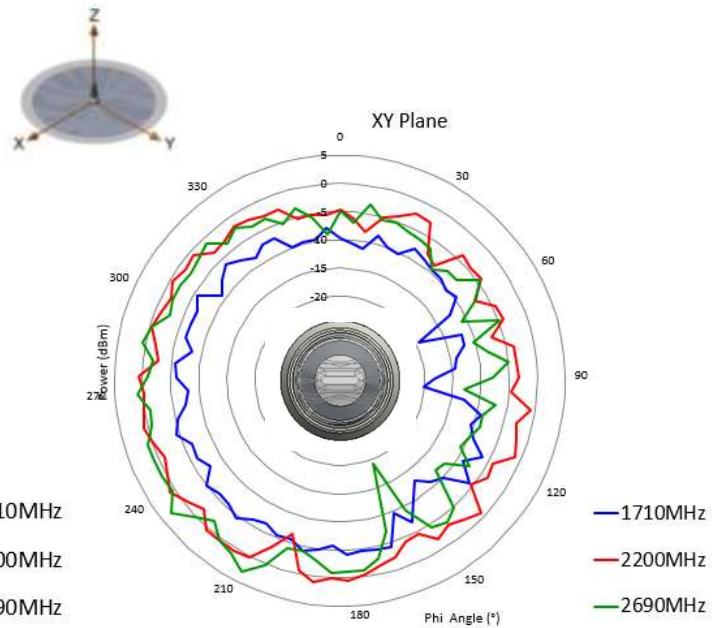
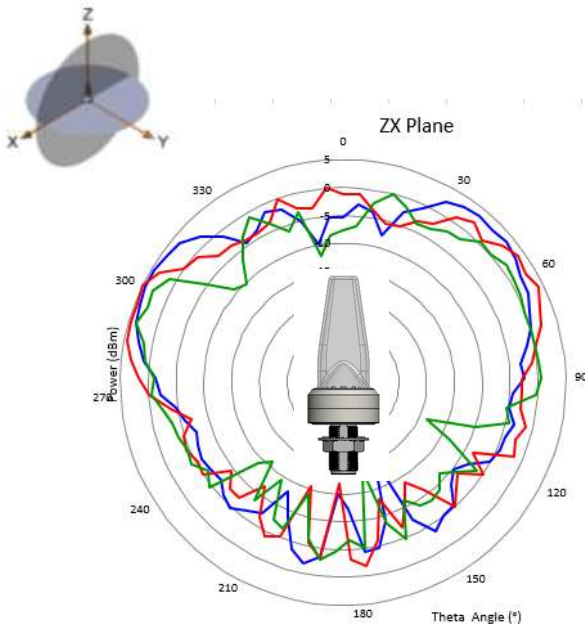

Issue: 1743

In the effort to improve our products, we reserve the right to make changes judged to be necessary.

CONFIDENTIAL AND PROPRIETARY INFORMATION

This document contains confidential and proprietary information of Pulse Electronics, Inc. (Pulse) and is protected by copyright, trade secret and other state and federal laws. Its receipt or possession does not convey any rights to reproduce, disclose its contents, or to manufacture, use or sell anything it may describe. Reproduction, disclosure or use without specific written authorization of Pulse is strictly forbidden.

Description: LOW PROFILE MULTIBAND ANTENNA

Series: IceFin

PART NUMBER: ICEFINXXX

CHARTS

Free Space Radiation Pattern

ICEFIN24NMOHF

Elevation Plane

Horizontal Plane

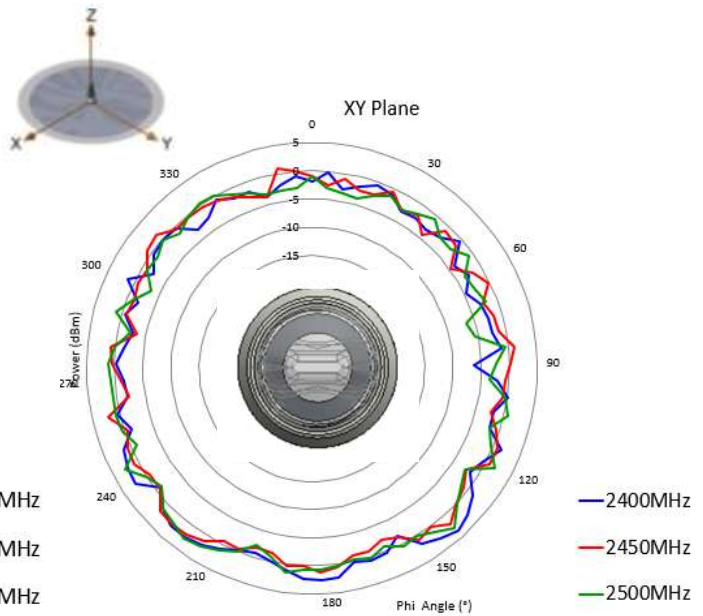
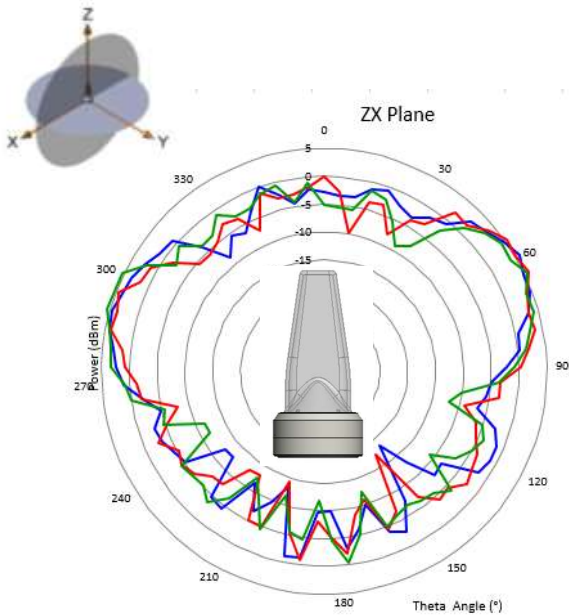

Issue: 1743

In the effort to improve our products, we reserve the right to make changes judged to be necessary.

CONFIDENTIAL AND PROPRIETARY INFORMATION

This document contains confidential and proprietary information of Pulse Electronics, Inc. (Pulse) and is protected by copyright, trade secret and other state and federal laws. Its receipt or possession does not convey any rights to reproduce, disclose its contents, or to manufacture, use or sell anything it may describe. Reproduction, disclosure or use without specific written authorization of Pulse is strictly forbidden.

Description: LOW PROFILE MULTIBAND ANTENNA

Series: IceFin

PART NUMBER: ICEFINXXX

CHARTS

Free Space Radiation Pattern

ICEFIN49NMOHF

Elevation Plane

Horizontal Plane

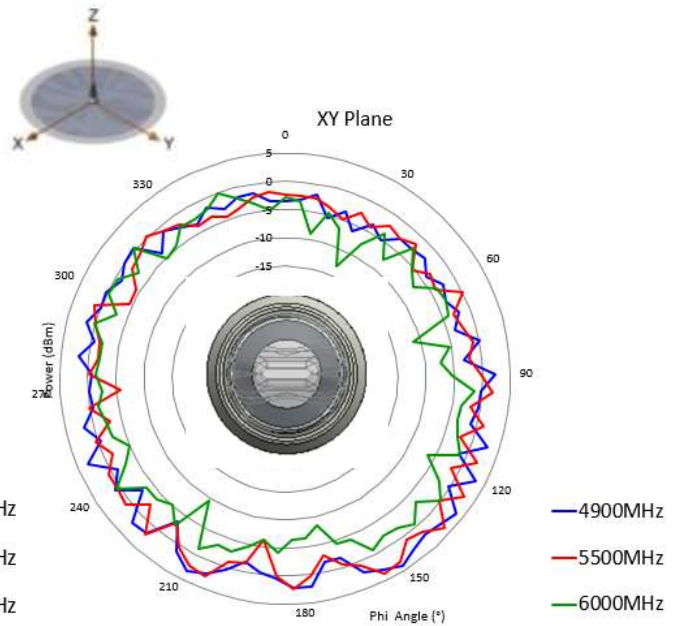
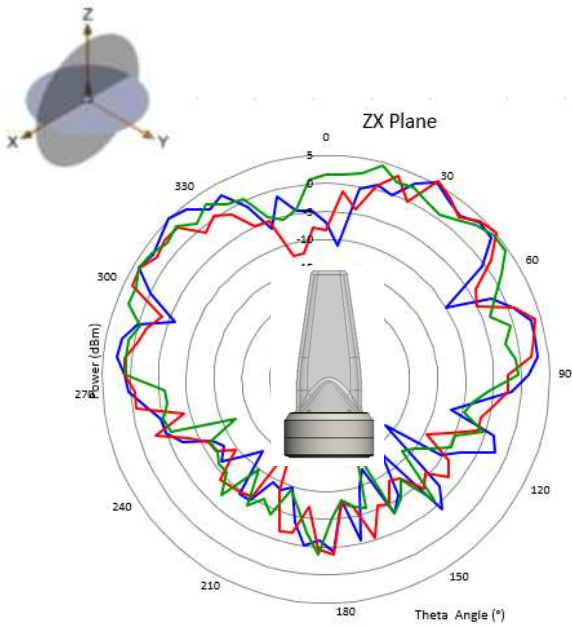

Issue: 1743

In the effort to improve our products, we reserve the right to make changes judged to be necessary.

CONFIDENTIAL AND PROPRIETARY INFORMATION

This document contains confidential and proprietary information of Pulse Electronics, Inc. (Pulse) and is protected by copyright, trade secret and other state and federal laws. Its receipt or possession does not convey any rights to reproduce, disclose its contents, or to manufacture, use or sell anything it may describe. Reproduction, disclosure or use without specific written authorization of Pulse is strictly forbidden.

Description: LOW PROFILE MULTIBAND ANTENNA

Series: IceFin

PART NUMBER: ICEFINXXX

CHARTS

Free Space Radiation Pattern

ICEFINWNMOHF

Elevation Plane

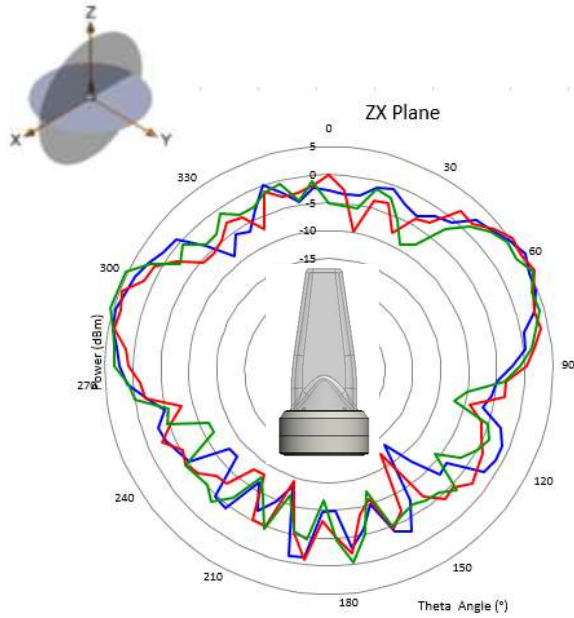

Horizontal Plane

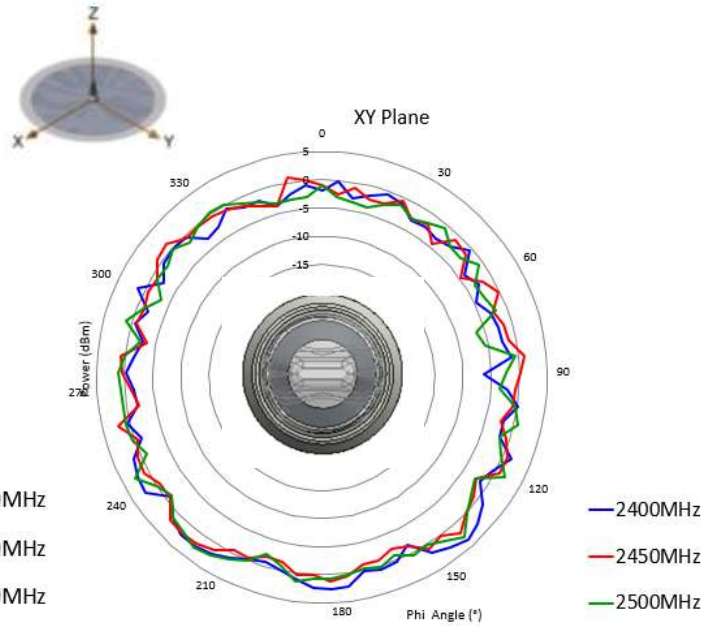

Issue: 1743

In the effort to improve our products, we reserve the right to make changes judged to be necessary.

CONFIDENTIAL AND PROPRIETARY INFORMATION

This document contains confidential and proprietary information of Pulse Electronics, Inc. (Pulse) and is protected by copyright, trade secret and other state and federal laws. Its receipt or possession does not convey any rights to reproduce, disclose its contents, or to manufacture, use or sell anything it may describe. Reproduction, disclosure or use without specific written authorization of Pulse is strictly forbidden.

Description: LOW PROFILE MULTIBAND ANTENNA

Series: IceFin

PART NUMBER: ICEFINXXX

CHARTS

Free Space Radiation Pattern

ICEFINWNMOHF

Elevation Plane

Horizontal Plane

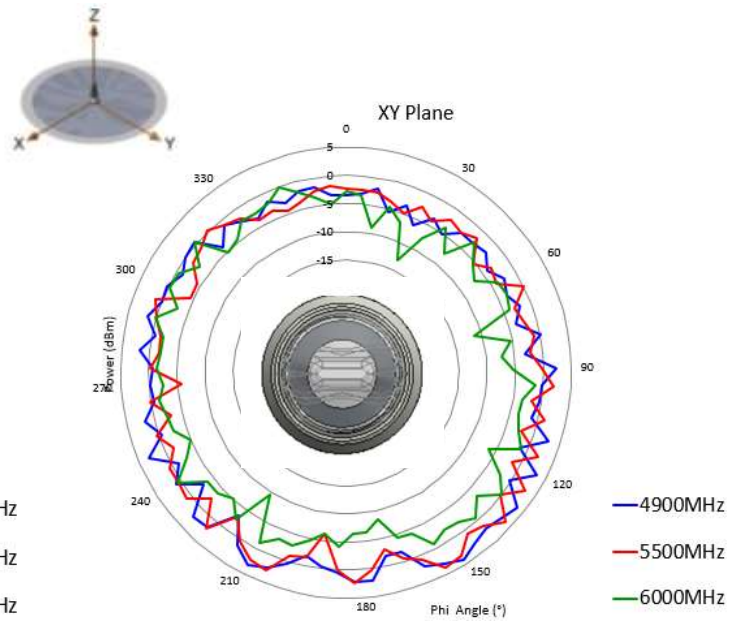
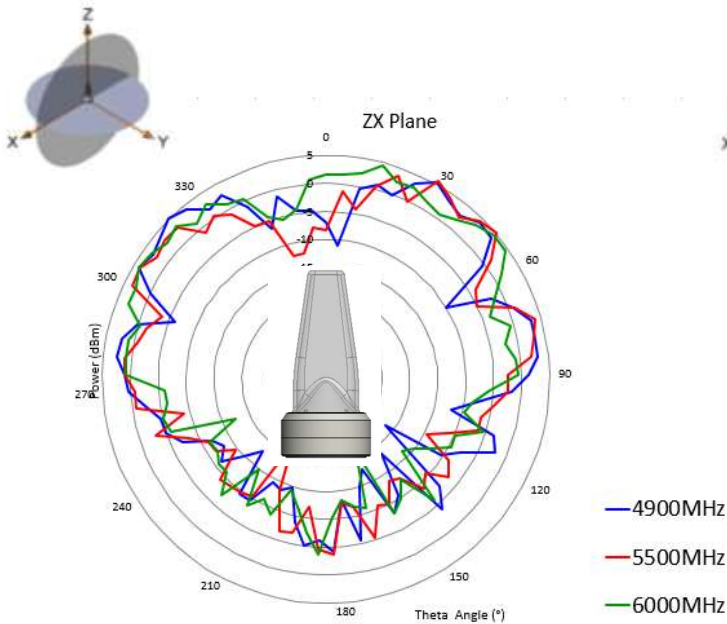

Issue: 1743

In the effort to improve our products, we reserve the right to make changes judged to be necessary.

CONFIDENTIAL AND PROPRIETARY INFORMATION

This document contains confidential and proprietary information of Pulse Electronics, Inc. (Pulse) and is protected by copyright, trade secret and other state and federal laws. Its receipt or possession does not convey any rights to reproduce, disclose its contents, or to manufacture, use or sell anything it may describe. Reproduction, disclosure or use without specific written authorization of Pulse is strictly forbidden.

Description: LOW PROFILE MULTIBAND ANTENNA

Series: IceFin

PART NUMBER: ICEFINXXX

CHARTS

Free Space Radiation Pattern

ICEFIN24DMN

Elevation Plane

Horizontal Plane

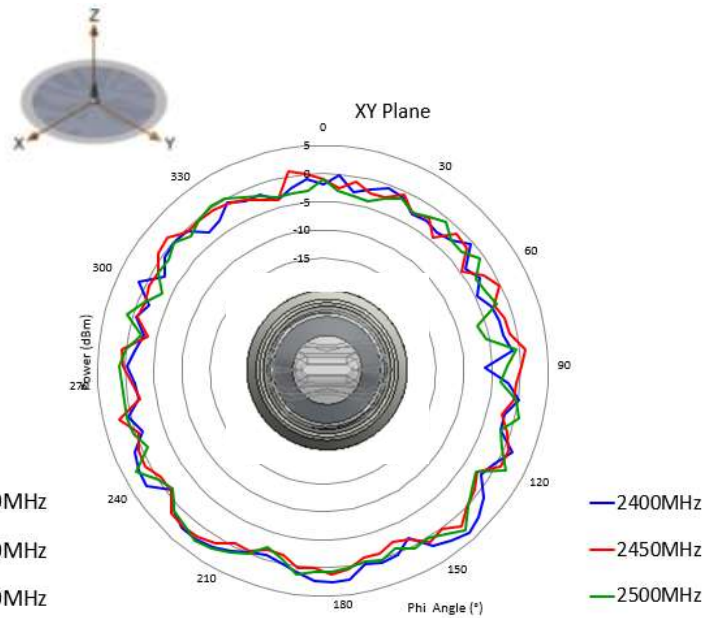
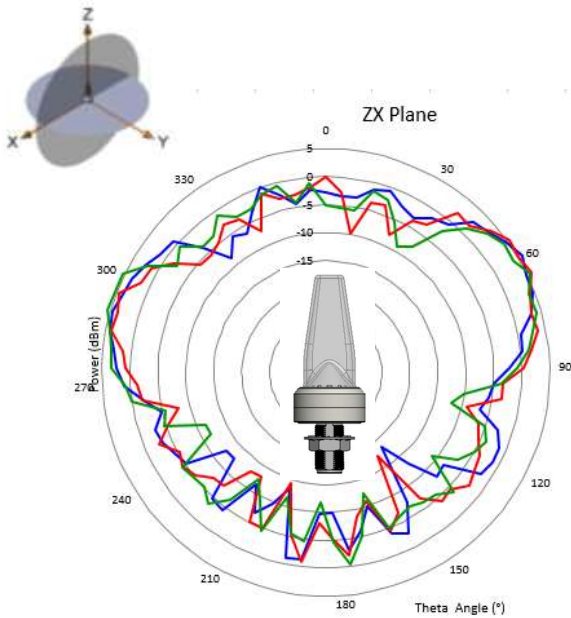

Issue: 1743

In the effort to improve our products, we reserve the right to make changes judged to be necessary.

CONFIDENTIAL AND PROPRIETARY INFORMATION

This document contains confidential and proprietary information of Pulse Electronics, Inc. (Pulse) and is protected by copyright, trade secret and other state and federal laws. Its receipt or possession does not convey any rights to reproduce, disclose its contents, or to manufacture, use or sell anything it may describe. Reproduction, disclosure or use without specific written authorization of Pulse is strictly forbidden.

Description: LOW PROFILE MULTIBAND ANTENNA

Series: IceFin

PART NUMBER: ICEFINXXX

CHARTS

Free Space Radiation Pattern

ICEFIN49DMN

Elevation Plane

Horizontal Plane

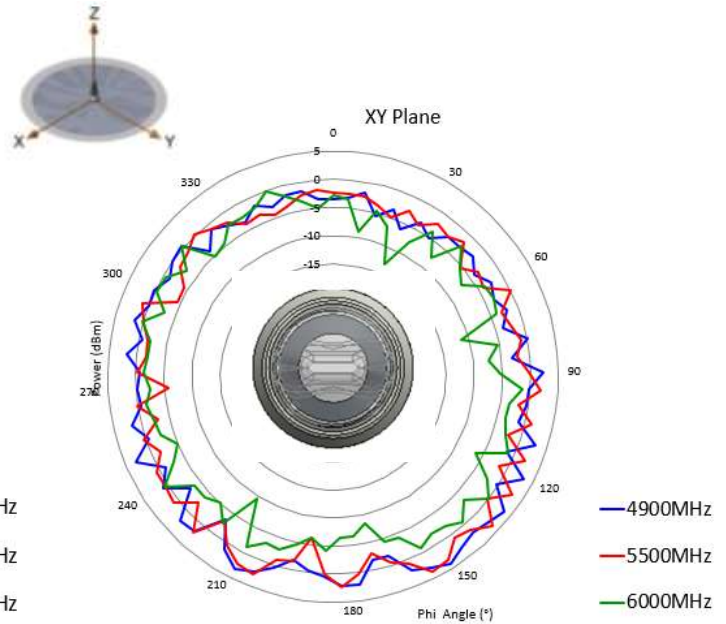
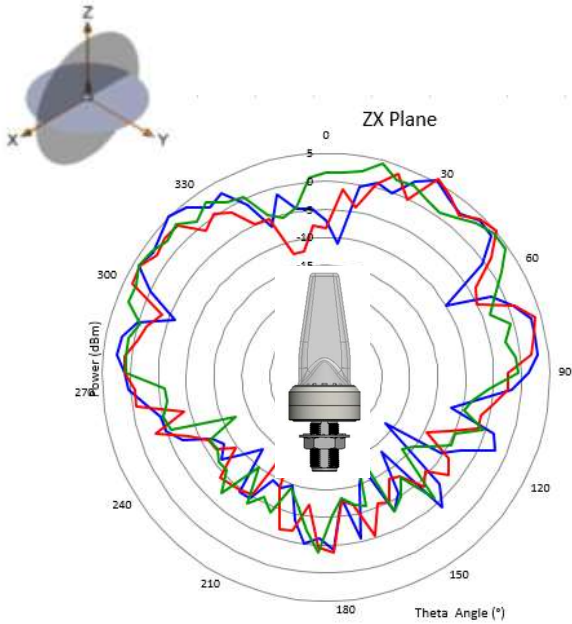

Issue: 1743

In the effort to improve our products, we reserve the right to make changes judged to be necessary.

CONFIDENTIAL AND PROPRIETARY INFORMATION

This document contains confidential and proprietary information of Pulse Electronics, Inc. (Pulse) and is protected by copyright, trade secret and other state and federal laws. Its receipt or possession does not convey any rights to reproduce, disclose its contents, or to manufacture, use or sell anything it may describe. Reproduction, disclosure or use without specific written authorization of Pulse is strictly forbidden.

Description: LOW PROFILE MULTIBAND ANTENNA

Series: IceFin

PART NUMBER: ICEFINXXX

CHARTS

Free Space Radiation Pattern

ICEFINWDMN

Elevation Plane

Horizontal Plane

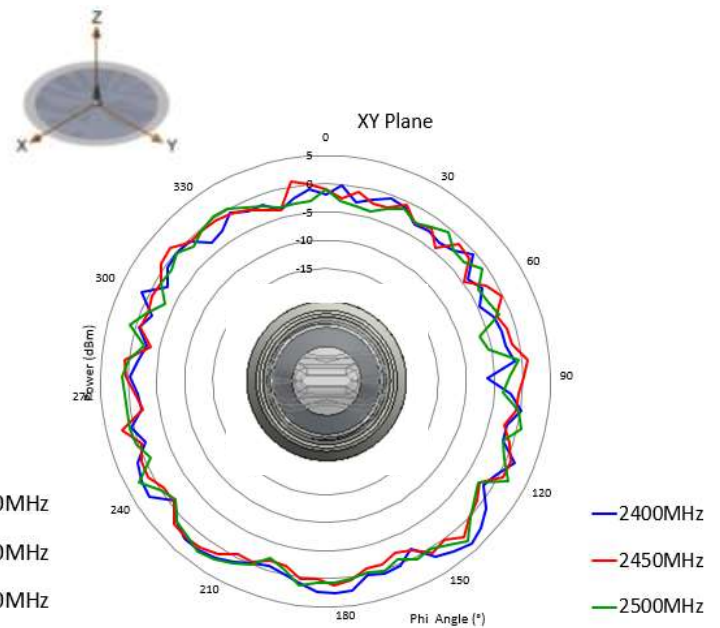
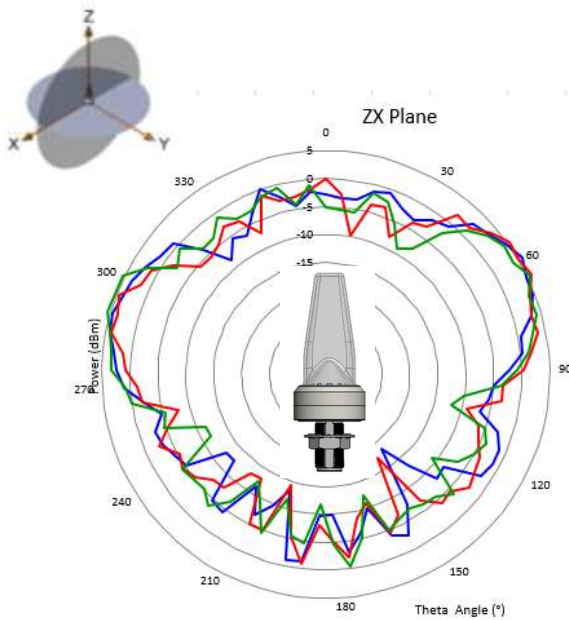

Issue: 1743

In the effort to improve our products, we reserve the right to make changes judged to be necessary.

CONFIDENTIAL AND PROPRIETARY INFORMATION

This document contains confidential and proprietary information of Pulse Electronics, Inc. (Pulse) and is protected by copyright, trade secret and other state and federal laws. Its receipt or possession does not convey any rights to reproduce, disclose its contents, or to manufacture, use or sell anything it may describe. Reproduction, disclosure or use without specific written authorization of Pulse is strictly forbidden.

Description: LOW PROFILE MULTIBAND ANTENNA

Series: IceFin

PART NUMBER: ICEFINXXX

CHARTS

Free Space Radiation Pattern

ICEFINWDMN

Elevation Plane

Horizontal Plane

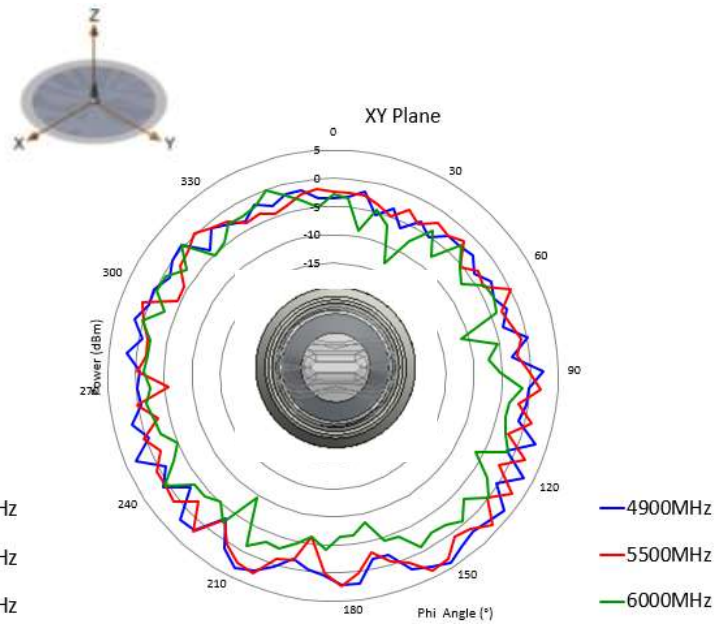
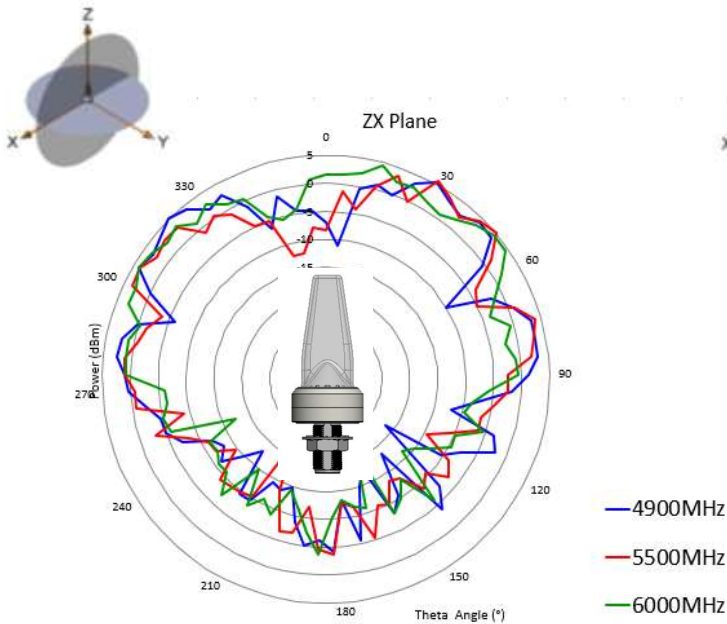

Issue: 1743

In the effort to improve our products, we reserve the right to make changes judged to be necessary.

CONFIDENTIAL AND PROPRIETARY INFORMATION

This document contains confidential and proprietary information of Pulse Electronics, Inc. (Pulse) and is protected by copyright, trade secret and other state and federal laws. Its receipt or possession does not convey any rights to reproduce, disclose its contents, or to manufacture, use or sell anything it may describe. Reproduction, disclosure or use without specific written authorization of Pulse is strictly forbidden.

Description: LOW PROFILE MULTIBAND ANTENNA

Series: IceFin

PART NUMBER: ICEFINXXX

PACKAGING

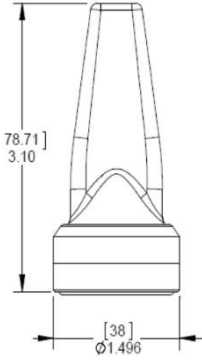
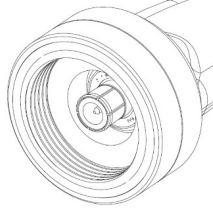
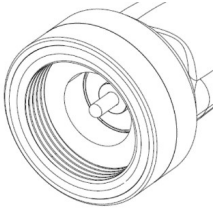
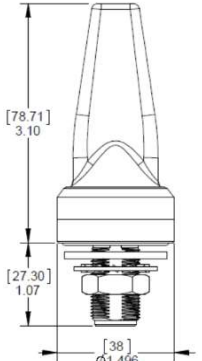
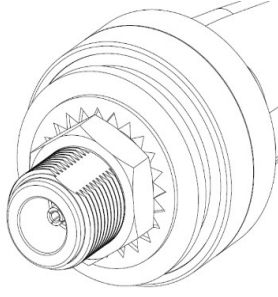
Project	Color	Frequency	Size	Fixing System Connector	Packaging
ICEFINLNMOHF	Clarity	698-960MHz 1710-2700MHz		 <p>NMOHF NMO + HF Connector</p>	<p>16 pcs / Tray 32 pcs / Carton</p>
ICEFIN698/960NMO	Clarity	750-960MHz		 <p>NMO Pogo Pin Connector</p>	
ICEFIN806NMO	Clarity	806-960MHz			
ICEFIN698/869DMN	Clarity	698-869MHz		 <p>DMN Direct Mount + N Female Connector (Screw 5/18-24 UNEF 2A)</p>	<p>96 pcs / Carton</p>
ICEFIN806DMN	Clarity	806-960MHz			
ICEFINLDMN	Clarity	698-960MHz 1710-2700MHz			

Issue: 1743

In the effort to improve our products, we reserve the right to make changes judged to be necessary.

CONFIDENTIAL AND PROPRIETARY INFORMATION

This document contains confidential and proprietary information of Pulse Electronics, Inc. (Pulse) and is protected by copyright, trade secret and other state and federal laws. Its receipt or possession does not convey any rights to reproduce, disclose its contents, or to manufacture, use or sell anything it may describe. Reproduction, disclosure or use without specific written authorization of Pulse is strictly forbidden.



Description: LOW PROFILE MULTIBAND ANTENNA

Series: IceFin

PART NUMBER: ICEFINXXX

PACKAGING

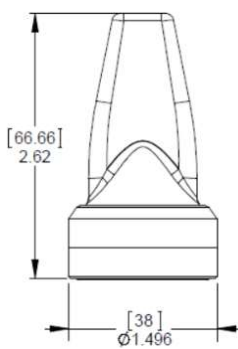
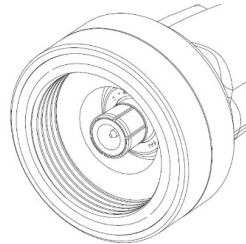
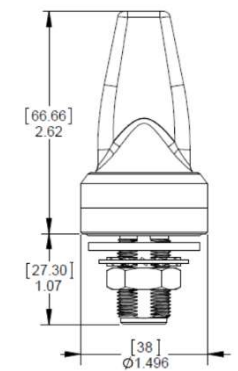
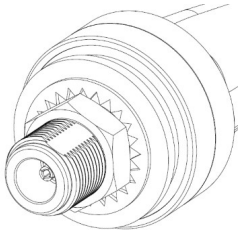
Project	Color	Frequency	Size	Fixing System Connector	Packaging
ICEFIN24NMOHF	Clarity	2400-2500MHz		 NMOHF NMO + HF Connector	16 pcs / Tray 32 pcs / Carton
ICEFIN49NMOHF	Clarity	4900-6000MHz			
ICEFINWNMOHF	Clarity	2400-2500MHz 4900-6000MHz			
ICEFIN24DMN	Clarity	2400-2500MHz		 Direct Mount N Female Connector (Screw 5/18-24 UNEF 2A)	96 pcs / Carton
ICEFIN49DMN	Clarity	4900-6000MHz			16 pcs / Tray 32 pcs / Carton
ICEFINWDMN	Clarity	2400-2500MHz 4900-6000MHz			96 pcs / Carton

Issue: 1743

In the effort to improve our products, we reserve the right to make changes judged to be necessary.

CONFIDENTIAL AND PROPRIETARY INFORMATION

This document contains confidential and proprietary information of Pulse Electronics, Inc. (Pulse) and is protected by copyright, trade secret and other state and federal laws. Its receipt or possession does not convey any rights to reproduce, disclose its contents, or to manufacture, use or sell anything it may describe. Reproduction, disclosure or use without specific written authorization of Pulse is strictly forbidden.



Данный компонент на территории Российской Федерации

Вы можете приобрести в компании MosChip.

Для оперативного оформления запроса Вам необходимо перейти по данной ссылке:

<http://moschip.ru/get-element>

Вы можете разместить у нас заказ для любого Вашего проекта, будь то серийное производство или разработка единичного прибора.

В нашем ассортименте представлены ведущие мировые производители активных и пассивных электронных компонентов.

Нашей специализацией является поставка электронной компонентной базы двойного назначения, продукции таких производителей как XILINX, Intel (ex.ALTERA), Vicor, Microchip, Texas Instruments, Analog Devices, Mini-Circuits, Amphenol, Glenair.

Сотрудничество с глобальными дистрибьюторами электронных компонентов, предоставляет возможность заказывать и получать с международных складов практически любой перечень компонентов в оптимальные для Вас сроки.

На всех этапах разработки и производства наши партнеры могут получить квалифицированную поддержку опытных инженеров.

Система менеджмента качества компании отвечает требованиям в соответствии с ГОСТ Р ИСО 9001, ГОСТ РВ 0015-002 и ЭС РД 009

Офис по работе с юридическими лицами:

105318, г.Москва, ул.Щербаковская д.3, офис 1107, 1118, ДЦ «Щербаковский»

Телефон: +7 495 668-12-70 (многоканальный)

Факс: +7 495 668-12-70 (доб.304)

E-mail: info@moschip.ru

Skype отдела продаж:

moschip.ru

moschip.ru_4

moschip.ru_6

moschip.ru_9