

48 x 48 Max. Counting Speed 40 KHZ Multicoloured LCD display (green-red) Part number 87621215



- Counter, Tachometer, Chronometer, Multi-totalizer, Batch counter, Preselection totalizer
- Maximum input frequency 40 k Hz
- Simple parameter setting, configuration using text menus
- Easy modification of presets
- Scaling factor
- 5 A changeover relay and solid state output
- Removable connectors
- Backlit LCD display (orange) : 2 lines, 6 digits or multicoloured display (green-red)
- IP 65 sealed panel
- Option of locking the keypad, completely or partially (preset, programming)
- Accessories for 72 x 72 or 55 x 55 cut-out, DIN rail adaptor

Part numbers

Type	Functions	Preset	Voltages	Output
87621215 Multicoloured LCD display (green-red)	Counter, Tachometer, Chronometer, Preselection multi-totalizer	1	90 →260 VAC	1 changeover relay, 1 solid state

Specifications

Physical details and protection

Supply	10 →30 VDC / 24 V AC / 90 →260 VAC
Relative humidity (no condensation)	EN 60068-2-30 40/93 % RLF
Altitude	0 < 2000 m
Certifications	UL - cULus (pending) - CE
Vibration resistance in 3 axes	10-55 Hz/1 min/XYZ EN 60068-2-6 : 30 min. in each direction
Connection by screw terminals	Removable
Protection	Conforming to standard EN 60529 IP65 for panel/IP20 for connections
Front panel watertight seal	▪
Temperature limits use (°C)	-20 →+65
Temperature limits stored (°C)	-25 →+75
Weight (g)	150 DC version 250 AC version

General characteristics

Reset to zero or to preset	On panel : if not locked during programming Electrical : automatic, voltage or solid state (NPN or PNP depending on programming)
Minimum pulse time	Impulse counter : < 15 ms Chronometer : 500 µs
Option to protect against reset from front panel	▪
Scale factor (each input pulse is multiplied by this figure)	00,0001 →99,9999
Scaling factor (each input impulse is divided by this value)	01,0000 →99,9999
Decimal point selectable for ease of reading	0 0,0 0,00 0,000 0,0000 0,00000
Sensor supply version AC	24 VDC -20/+15 % 50 mA
Programming and current value backed up via EEPROM memory	▪ Service life 10 years

Operating characteristics

Functions	Preselection counter, Tachometer, Chronometer, Multi-totalizer, Batch counters, Totalizer
Number of presets	1 or 2
Display	LCD with orange backlighting/Multicoloured LCD (green-red)
Height digits (mm)	LCD 9
Display details	- 999 999 →999 999

Inputs specifications

Inputs	2 counter inputs 1 reset input, 1 gate input
Input modes	Dir : Directional AS : up/dn AA : up/up PP : phase PP2 : phase 2 PP4 : phase 4
Input type	Voltage or solid state
High level	8 VDC→30 VDC
Low level	0 →2 VDC

Solid state output characteristics

Maximum current	30 mA
Max. voltage	10 →30 VDC for the DC version 24 VDC -20/+15 %

Relay output characteristics

Changeover relay	•
NO contact	Depending on version
Maximum current	5 A
Minimum current	10 mA
Maximum voltage	30 VDC / 250 VAC
Min. voltage	5 VAC/DC
Response time	< 13 ms
Mechanical life (operations)	20 x 10 ⁶
Number of operations to 5 A	5 x 10 ⁴
Output modes : maintained or pulsed	0.01 →99.99 s

Accessories

Description	Code
Adaptor for 72 x 72 mm cut-out	26546842
Adaptor for 55 x 55 mm cut-out	26546846
DIN rail adaptor	26546841

Principles

N°	Legend
1	Current value
2	Selected value
3	Chronometer display
4	Active output indication
5	Shows which value is displayed
6	Prog/mode button
7	Preset control buttons
8	Button required for programming parameters

Dimensions (mm)

N°	Legend
①	10.5 max.

Dimensions (mm)

26546842 - Adaptor for 72 x 72 mm cut-out



Dimensions (mm)

26546846 - Adaptor for 55 x 55 mm cut-out



Dimensions (mm)

Panel cut-out



Dimensions (mm)

26546841 - DIN rail adaptor



Curves

Counter : dir

dir



Inp A : counter input Inp B : count direction rS0 : Display 0 →Preset rSP2 : Display Preset →0

Curves

Counter : AS

AS



Inp A : Add. counter input 1 Inp B : Sub.. counter input 2 rS0 : Display 0 →Preset rSP2 : Display Preset →0

Curves

Counter : AA

AA



Inp A : Add. counter input 1 Inp B : Sub.. counter input 2 rS0 : Display 0 →Preset

Curves

Counter : PP

PP

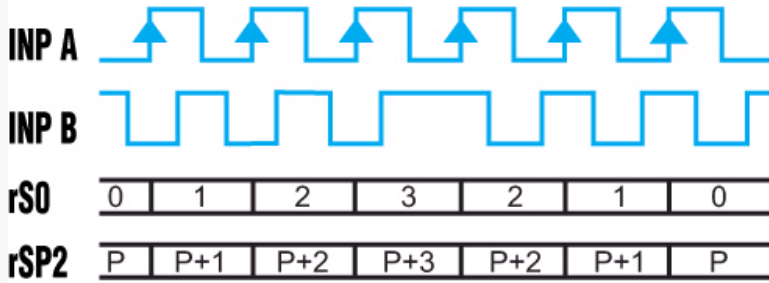

A 90° B Inp A : Counter input Counting on an edge Inp B : Reversal of direction rS0 : Display 0 →Preset rSP2 : Display Preset →0

Curves

Counter : PP2

PP2



A 90° B Inp A : Counter input Counting on a rising edge and on a falling edge Inp B : Reversal of direction rS0 : Display 0 →Preset rSP2 : Display Preset →0

Curves

Counter : PP4

PP4



A 90° B Inp A : Counter input Counting on a rising edge and on a falling edge Inp B : Counter input Counting on a rising edge and on a falling edge, reversal of direction rS0 : Display 0 →Preset rSP2 : Display Preset →0

Curves

Chronometer : Start tcCb



Inp A : No function Inp B : On/Off Cumulative time counting while B is active Add : Display 0 →Preset Sub : Display Preset →0

Curves

Chronometer : Start tcCbb

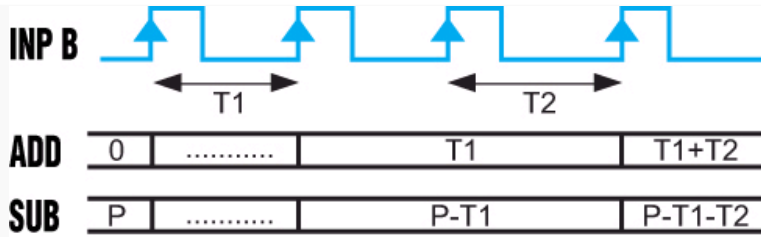

Inp A : No function Inp B : On/Off Cumulative time counting Add : Display 0 →Preset Sub : Display Preset →0

Curves

Chronometer : Start tcCAb

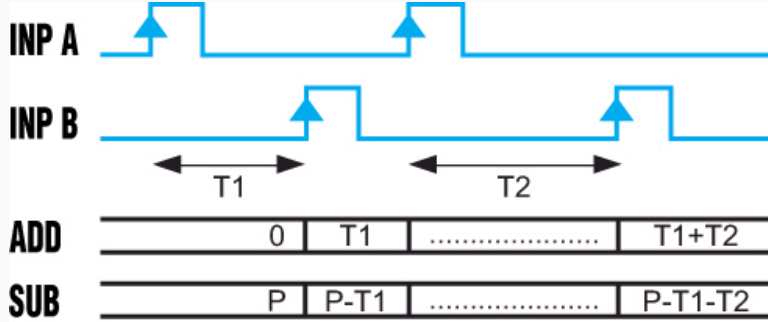

Inp A : On Inp B : Off Cumulative time counting Add : Display 0 →Preset Sub : Display Preset →0

Curves

Chronometer : Start tcSb

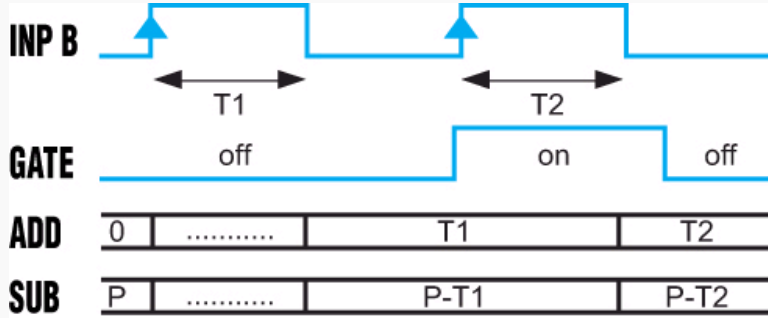

Inp A : No function Inp B : On/Off Individual time counting, automatic reset before each new count Add : Display 0 →Preset Sub : Display Preset →0

Curves

Chronometer : Start tcSbb

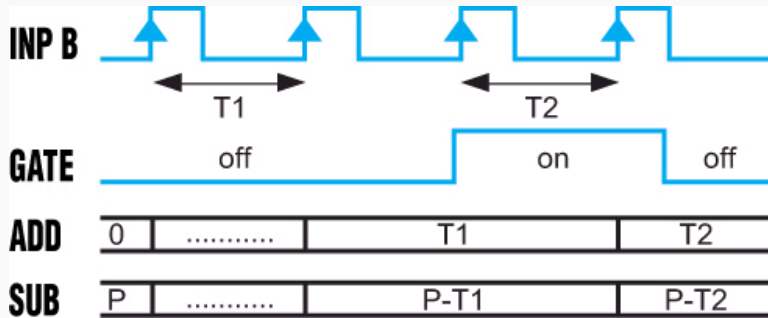

Inp A : No function Inp B : On/Off Individual time counting, automatic reset before each new count Add : Display 0 →Preset Sub : Display Preset →0

Curves

Chronometer : Start tcSAB



Inp A : On Inp B : Off Individual time counting, automatic reset before each new count Add : Display 0 →Preset Sub : Display Preset →0

Curves

Chronometer : Start tcAuto

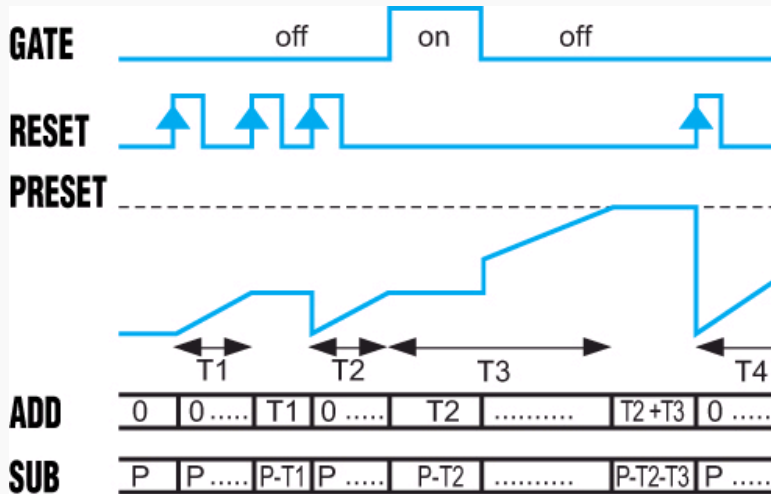

Inp A : No function Inp B : No function Time counting command via Reset (manual or electrical) Add : Display 0 →Preset Sub : Display Preset →0 The Gate input has a display memory function

Curves

Tachometer : Start tA.A

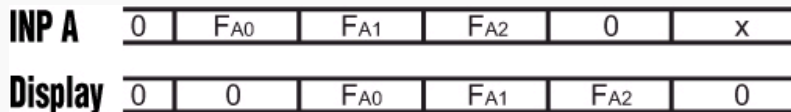

Inp A : Frequency input Inp B : No function

Curves

Tachometer : Start tA.AS

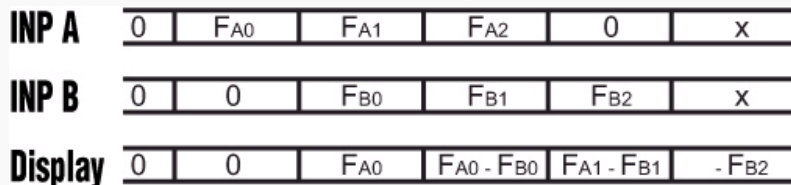

Inp A : Frequency input 1 Inp B : Frequency input 2 Formula : A - B

Curves

Tachometer : Start tA.AA

INP A	0	F_{A0}	F_{A1}	F_{A2}	0	x
INP B	0	0	F_{B0}	F_{B1}	F_{B2}	x
Display	0	0	F_{A0}	$F_{A0} + F_{B0}$	$F_{A1} + F_{B1}$	F_{B2}

Inp A : Frequency input 1 Inp B : Frequency input 2 Formula : A + B

Curves

Tachometer : Start tA.PP



A 90° B Inp A : Frequency input 1 Inp B : Reversal of direction

Curves

Output operation : OutoP rS0



A 90° B Inp A : Frequency input 1 Inp B : Reversal of direction

Curves

Output operation : OutoP rSA0



A 90° B Inp A : Frequency input 1 Inp B : Reversal of direction

Curves

Output operation : OutoP bCrSA0



A 90° B Inp A : Frequency input 1 Inp B : Reversal of direction

Curves

Output operation : OutoP tCrSA0



A 90° B Inp A : Frequency input 1 Inp B : Reversal of direction

Curves

Output operation : OutoP rSP2



A 90° B Inp A : Frequency input 1 Inp B : Reversal of direction

Curves

Output operation : OutoP rSAP2



A 90° B Inp A : Frequency input 1 Inp B : Reversal of direction

Curves

Output operation : OutoPbCrSA2



A 90° B Inp A : Frequency input 1 Inp B : Reversal of direction

Curves

Output operation : OutoP tCrSA2



A 90° B Inp A : Frequency input 1 Inp B : Reversal of direction

Curves

Output operation : OutoP bCrS0



A 90° B Inp A : Frequency input 1 Inp B : Reversal of direction

Curves

Output operation : OutoP tCrS0

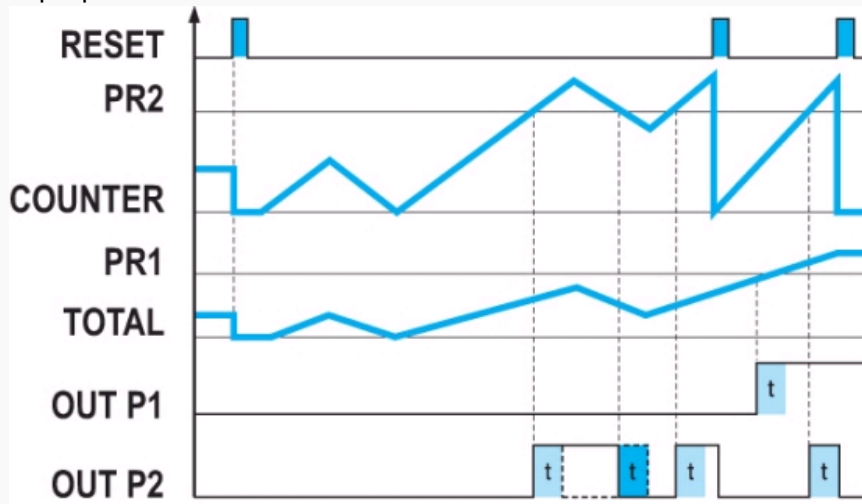

A 90° B Inp A : Frequency input 1 Inp B : Reversal of direction

Curves

Output operation : OutoP MurS0 (AA)



A 90° B Inp A : Frequency input 1 Inp B : Reversal of direction

Curves

Output operation : OutoP bCrSP2



A 90° B Inp A : Frequency input 1 Inp B : Reversal of direction

Curves

Output operation : OutoP tCrSP2



A 90° B Inp A : Frequency input 1 Inp B : Reversal of direction

Curves

Output operation : OutoP MurS0 (AS)



A 90° B Inp A : Frequency input 1 Inp B : Reversal of direction

Connections

87621111 / 211



Output : 5 A/250 VAC/AC : 24 VAC

N°	Legend
①	Sensor voltage supply (* UB interconnected)
②	GND (0 VDC)
③	INP A (signal A input)
④	INP B (signal B input)
⑤	Reset (Reset input)
⑥	Gate input
⑦	Output 1 - 10-30 VDC/30 mA
⑧	11-12-13 : Output 1
⑨	14-15 : Supply

Connections

87621112 / 212



Output : 5 A/250 VAC/AC : 90 260 VDC

N°	Legend
1	Sensor voltage supply
2	GND (0 VDC)
3	INP A (signal A input)
4	INP B (signal B input)
5	Reset (Reset input)
6	Gate input
7	Output 1 - 24 VDC/30 mA
8	11-12-13 : Output 1
9	14-15 : Supply

Connections

87621115 / 215



Output : 5 A/250 VAC/AC : 24 VAC

N°	Legend
①	Sensor voltage supply
②	GND (0 VDC)
③	INP A (signal A input)
④	INP B (signal B input)
⑤	Reset (Reset input)
⑥	Gate input
⑦	Output 1 - 24 VDC/30 mA
⑧	11-12-13 : Output 1
⑨	14-15 : Supply

Connections

87621121 / 221



Output : 5 A/250 VAC/DC : 10 30 VDC

N°	Legend
①	Sensor voltage supply (* UB interconnected)
②	GND (0 VDC)
③	INP A (signal A input)
④	INP B (signal B input)
⑤	Reset (Reset input)
⑥	Gate input
⑦	Output 1 : 10-30 VDC/30 mA
⑧	Output 2 : 10-30 VDC/30 mA
⑨	9-10 : Output 1
⑩	11-12-13 : Output 2
⑪	14-15 : Supply

Connections

87621122 / 222



Output : 5 A/250 VAC/AC : 90 260 DC

N°	Legend
①	Sensor voltage supply
②	GND (0 VDC)
③	INP A (signal A input)
④	INP B (signal B input)
⑤	Reset (Reset input)
⑥	Gate input
⑦	Output 1 : 24 VDC/30 mA
⑧	Output 2 : 24 VDC/30 mA
⑨	9-10 : Output 1
⑩	11-12-13 : Output 2
⑪	14-15 : Supply

Connections

87621125 / 225



Output : 5 A/250 VAC/AC : 90 260 VDC

N°	Legend
①	Sensor voltage supply
②	GND (0 VDC)
③	INP A (signal A input)
④	INP B (signal B input)
⑤	Reset (Reset input)
⑥	Gate input
⑦	Output 1 : 24 VDC/30 mA
⑧	Output 2 : 24 VDC/30 mA
⑨	9-10 : Output 1
⑩	11-12-13 : Output 2
⑪	14-15 : Supply

Applications

Programming diagram



Данный компонент на территории Российской Федерации

Вы можете приобрести в компании MosChip.

Для оперативного оформления запроса Вам необходимо перейти по данной ссылке:

<http://moschip.ru/get-element>

Вы можете разместить у нас заказ для любого Вашего проекта, будь то серийное производство или разработка единичного прибора.

В нашем ассортименте представлены ведущие мировые производители активных и пассивных электронных компонентов.

Нашей специализацией является поставка электронной компонентной базы двойного назначения, продукции таких производителей как XILINX, Intel (ex.ALTERA), Vicor, Microchip, Texas Instruments, Analog Devices, Mini-Circuits, Amphenol, Glenair.

Сотрудничество с глобальными дистрибьюторами электронных компонентов, предоставляет возможность заказывать и получать с международных складов практически любой перечень компонентов в оптимальные для Вас сроки.

На всех этапах разработки и производства наши партнеры могут получить квалифицированную поддержку опытных инженеров.

Система менеджмента качества компании отвечает требованиям в соответствии с ГОСТ Р ИСО 9001, ГОСТ РВ 0015-002 и ЭС РД 009

Офис по работе с юридическими лицами:

105318, г.Москва, ул.Щербаковская д.3, офис 1107, 1118, ДЦ «Щербаковский»

Телефон: +7 495 668-12-70 (многоканальный)

Факс: +7 495 668-12-70 (доб.304)

E-mail: info@moschip.ru

Skype отдела продаж:

moschip.ru

moschip.ru_4

moschip.ru_6

moschip.ru_9