

Miniature Power PCB Relay MSR V23061

- 1 pole 8/10A, 1form C (CO) or 1 form A (NO) contact
- High inrush currents with AgSnO₂ contacts (TV4 0 65A)
- 4kV/8mm coil-contact
- Reinforced insulation (protection class II)
- Ambient temperature up to 85°C at 8A
- Plastic materials according to IEC 60335-1 (domestic appliances)

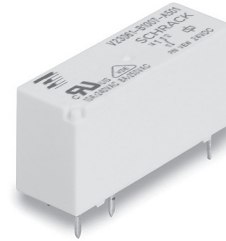

Typical applications

HVAC, interface technology. PLC's, power supplies, TV-/monitor control, domestic appliances, Hi-Fi products, timers.



Approvals

VDE Cert. No. 40017849, UL E214025
Technical data of approved types on request.

Contact Data

Contact arrangement	1 form C (CO) or 1 form A (NO)
Rated voltage	250VAC
Max. switching voltage	400VAC
Rated current	
versions A,B	8A
versions C, D	10A
Limiting making current, max 4s, df 10%	15A
version A302, max 20ms	65A
Breaking capacity max.	2000VA
Contact material	AgSnO ₂ , AgNi90/10
Frequency of operation, with/without load	6/1200min-1
Operate/release time max.	10/5ms
Bounce time max., form A/form B	3/10ms

Contact ratings

Type	Contact	Load	Cycles
IEC 61810			
V23061-A1***-A302	A (NO)	8A, 250VAC, cosφ=1, 85°C	100x10 ³
V23061-C2***-A802	A (NO)	10A, 250VAC, cosφ=1, 85°C	100x10 ³
V23061-C2***-A802	A (NO)	5A, 250VAC, cosφ=1, 105°C	100x10 ³
UL 508			
V23061-A1***-A302	A (NO)	TV4, Tungsten, 120VAC, 40°C	25x10 ³
V23061-A1***-A302	A (NO)	Pilot duty, A300, 40°C	6x10 ³
V23061-C2***-A802	A (NO)	10A, 240VAC, general purpose, 40°C	30x10 ³
EN60730-1			
V23061-A1***-A302	A (NO)	2(2)A, 250VAC, 85°C	100x10 ³
V23061-C2***-A802	A (NO)	4(4)A, 250VAC, 85°C	100x10 ³

Mechanical endurance, DC coil 10x10⁶ operations



Coil Data

Coil voltage range	3 to 60VDC
Operative range, IEC 61810	2
Coil insulation system according UL	classA or classF

Coil versions, DC coil

Coil code	Rated voltage VDC	Operate voltage VDC	Release voltage VDC	Coil resistance Ω±10% ¹⁾	Rated coil power mW
001	3	2.1	0.3	40	225
002	5	3.4	0.5	118	212
003	6	4.1	0.6	165	218
004	9	6.1	0.9	364	223
005	12	8.2	1.2	652	221
007	24	16.3	2.4	2270	254
009	48	32.6	4.8	8790	262
010	60	40.8	6.0	15265 ¹⁾	236

1) Coil resistance ±15%.

All figures are given for coil without pre-energization, at ambient temperature +23°C. Other coil voltages on request.



Insulation Data

Initial dielectric strength	
between open contacts	1000V _{rms}
between contact and coil	4000V _{rms}
Clearance/creepage	
between contact and coil	≥8/8mm
Material group of insulation parts	IIla

Miniature Power PCB Relay MSR V23061 (Continued)

Other Data

Material compliance: EU RoHS/ELV, China RoHS, REACH, Halogen content refer to the Product Compliance Support Center at www.te.com/customersupport/rohssupportcenter

Ambient temperature	- 40 to +85°C	
Category of environmental protection	IEC 61810	RTII - flux proof, RTIII - wash tight
Vibration resistance (functional)	form A (NO) / form B (NC)	10/4g
Vibration resistance (destructive)	form A (NO) / form B (NC)	20/5g
Shock resistance (destructive)		100g
Terminal type	PCB-THT	
Weight	11g	
Resistance to soldering heat THT	IEC 60068-2-20	
	RTII: 270°C/10s	RTIII: 260°C/5s
Packaging/unit	tube/20 pcs., box/1000 pcs.	

PCB layout / terminal assignment

1 form C, 1 CO contact, 3.2mm



1 form A, 1 NO contact, 5mm

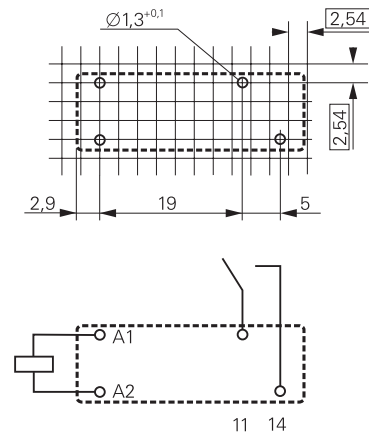

Dimensions

1 form C, 1 CO contact, 3.2mm

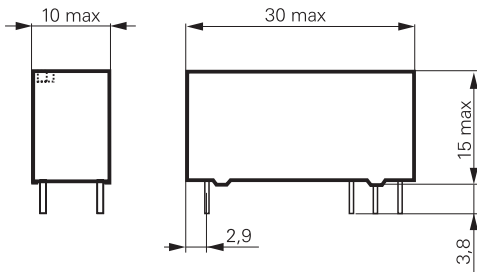

1 form A, 1 NO contact, 5mm

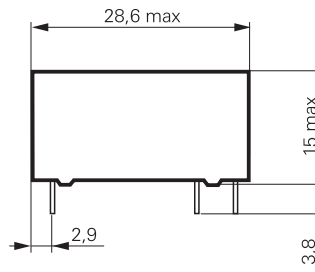

Miniature Power PCB Relay MSR V23061 (Continued)

Product code structure	Typical product code	V23061	-A	1	007	-A	3	02
Type V23061	Miniature Power PCB Relay MSR							
Version	<ul style="list-style-type: none"> A 1 form A contact (1 NO), UL-class A B 1 form C contact (1 CO), UL-class A C 1 form A contact (1 NO), UL-class F D 1 form C contact (1 CO), UL-class F 							
Version	<ul style="list-style-type: none"> 1 Wash tight 2 Flux proof 							
Coil	Coil-code: please refer to coil versions table							
Contact system	<ul style="list-style-type: none"> A Standard 							
Contact material	<ul style="list-style-type: none"> 3 AgSnO₂ 8 AgNi 90/10 							
Contact information	<ul style="list-style-type: none"> 01 1 form C (CO) contact 02 1 form A (NO) contact 							

Other types on request

Product code	Version	Contacts	Contact material	Coil	Part Number
V23061-A1002-A302	Wash tight	1 form A	AgSnO ₂	5VDC	1393222-4
V23061-A1003-A302		1 NO contact		6VDC	1393222-9
V23061-A1005-A302				12VDC	2-1393222-0
V23061-A1007-A302				24VDC	3-1393222-9
V23061-B1002-A301		1 form C		5VDC	7-1393222-2
V23061-B1005-A301		1 CO contact		12VDC	9-1393222-1
V23061-B1007-A301				24VDC	1-1393223-7
V23061-B1009-A301				48VDC	3-1393223-7
V23061-C2001-A802	Flux proof	1 form A	AgNi 90/10	3VDC	5-1416200-3
V23061-C2002-A802		1 NO contact		5VDC	5-1416200-4
V23061-C2003-A802				6VDC	5-1416200-5
V23061-C2004-A802				9VDC	5-1416200-6
V23061-C2005-A802				12VDC	5-1416200-0
V23061-C2007-A802				24VDC	5-1416200-8
V23061-C2009-A802				48VDC	6-1416200-0
V23061-C2010-A802				60VDC	6-1416200-1
V23061-D2001-A801		1 form C		3VDC	6-1416200-2
V23061-D2002-A801		1 CO contact		5VDC	6-1416200-3
V23061-D2003-A801				6VDC	6-1416200-4
V23061-D2004-A801				9VDC	6-1416200-5
V23061-D2005-A801				12VDC	6-1416200-6
V23061-D2007-A801				24VDC	6-1416200-7
V23061-D2009-A801				48VDC	6-1416200-9
V23061-D2010-A801				60VDC	7-1416200-0

Данный компонент на территории Российской Федерации

Вы можете приобрести в компании MosChip.

Для оперативного оформления запроса Вам необходимо перейти по данной ссылке:

<http://moschip.ru/get-element>

Вы можете разместить у нас заказ для любого Вашего проекта, будь то серийное производство или разработка единичного прибора.

В нашем ассортименте представлены ведущие мировые производители активных и пассивных электронных компонентов.

Нашей специализацией является поставка электронной компонентной базы двойного назначения, продукции таких производителей как XILINX, Intel (ex.ALTERA), Vicor, Microchip, Texas Instruments, Analog Devices, Mini-Circuits, Amphenol, Glenair.

Сотрудничество с глобальными дистрибьюторами электронных компонентов, предоставляет возможность заказывать и получать с международных складов практически любой перечень компонентов в оптимальные для Вас сроки.

На всех этапах разработки и производства наши партнеры могут получить квалифицированную поддержку опытных инженеров.

Система менеджмента качества компании отвечает требованиям в соответствии с ГОСТ Р ИСО 9001, ГОСТ РВ 0015-002 и ЭС РД 009

Офис по работе с юридическими лицами:

105318, г.Москва, ул.Щербаковская д.3, офис 1107, 1118, ДЦ «Щербаковский»

Телефон: +7 495 668-12-70 (многоканальный)

Факс: +7 495 668-12-70 (доб.304)

E-mail: info@moschip.ru

Skype отдела продаж:

moschip.ru

moschip.ru_4

moschip.ru_6

moschip.ru_9