



SY58605U

3.2Gbps Precision, LVDS Buffer with Internal Termination and Fail Safe Input

General Description

The SY58605U is a 2.5V, high-speed, fully differential LVDS buffer optimized to provide less than 10ps_{pp} total jitter. The SY58605U can process clock signals as fast as 2GHz or data patterns up to 3.2Gbps.

The differential input includes Micrel's unique, 3-pin input termination architecture that interfaces to LVPECL, LVDS or CML differential signals, (AC- or DC-coupled) as small as 100mV (200mV_{pp}) without any level-shifting or termination resistor networks in the signal path. For AC-coupled input interface applications, an integrated voltage reference (V_{REF-AC}) is provided to bias the V_T pin. The output is 325mV LVDS, with rise/fall times guaranteed to be less than 100ps.

The SY58605U operates from a 2.5V ±5% supply and is guaranteed over the full industrial temperature range (–40°C to +85°C). For applications that require CML or LVPECL outputs, consider Micrel's SY58603U and SY58604U, buffers with 400mV and 800mV output swings respectively. The SY58605U is part of Micrel's high-speed, Precision Edge[®] product line.

Datasheets and support documentation can be found on Micrel's web site at: www.micrel.com.

Functional Block Diagram

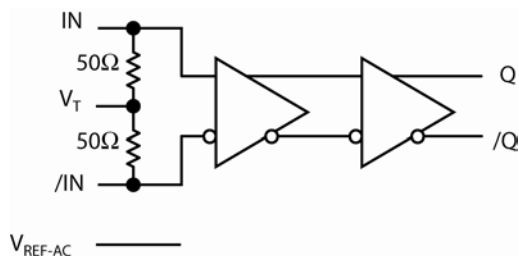

Precision Edge[®]

Features

- Precision 325mV LVDS buffer
- Guaranteed AC performance over temperature and voltage:
 - DC-to > 3.2Gbps throughput
 - <300ps typical propagation delay (IN-to-Q)
 - <100ps rise/fall times
- Fail Safe Input
 - Prevents output from oscillating when input is invalid
- Ultra-low jitter design
 - <1ps_{RMS} cycle-to-cycle jitter
 - <10ps_{pp} total jitter
 - <1ps_{RMS} random jitter
 - <10ps_{pp} deterministic jitter
- High-speed LVDS output
- 2.5V ±5% power supply operation
- Industrial temperature range: –40°C to +85°C
- Available in 8-pin (2mm x 2mm) DFN package

Applications

- All SONET clock and data distribution
- Fibre Channel clock and data distribution
- Gigabit Ethernet clock and data distribution
- Backplane distribution

Markets

- Storage
- ATE
- Test and measurement
- Enterprise networking equipment
- High-end servers
- Access
- Metro area network equipment

Precision Edge is a registered trademark of Micrel, Inc.

Micrel Inc. • 2180 Fortune Drive • San Jose, CA 95131 • USA • tel +1 (408) 944-0800 • fax + 1 (408) 474-1000 • <http://www.micrel.com>

August 2007

M9999-082907-B
hbwhelp@micrel.com or (408) 955-1690

Ordering Information⁽¹⁾

Part Number	Package Type	Operating Range	Package Marking	Lead Finish
SY58605UMG	DFN-8	Industrial	605 with Pb-Free bar-line indicator	NiPdAu Pb-Free
SY58605UMGTR ⁽²⁾	DFN-8	Industrial	605 with Pb-Free bar-line indicator	NiPdAu Pb-Free

Notes:

- Contact factory for die availability. Dice are guaranteed at $T_A = 25^\circ\text{C}$, DC Electricals only.
- Tape and Reel.

Pin Configuration

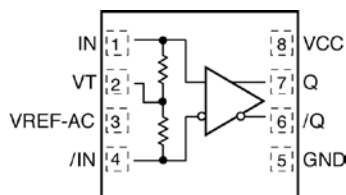

8-Pin DFN

Pin Description

Pin Number	Pin Name	Pin Function
1, 4	IN, /IN	Differential Input: This input pair is the differential signal input to the device. Input accepts DC-coupled differential signals as small as 100mV (200mV _{PP}). Each pin of this pair internally terminates with 50Ω to the VT pin. If the input swing falls below a certain threshold (typically 30mV), then the Fail Safe Input (FSI) feature will guarantee a stable output by latching the output to its last valid state. See "Input Interface Applications" subsection for more details.
2	VT	Input Termination Center-Tap: Each input terminates to this pin. The V _T pin provides a center-tap for each input (IN, /IN) to a termination network for maximum interface flexibility. See "Input Interface Applications" subsection for more details.
3	VREF-AC	Reference Voltage: This output biases to V _{CC} -1.2V. It is used for AC-coupling input IN and /IN. Connect VREF-AC directly to the VT pin. Bypass with 0.01μF low ESR capacitor to VCC. Maximum sink/source current is ±1.5mA. See "Input Interface Applications" subsection for more details.
5	GND, Exposed pad	Ground: Exposed pad must be connected to a ground plane that is the same potential as the ground pin.
6, 7	/Q, Q	LVDS Differential Output Pair: The output swing is typically 325mV. Normally terminated with 100Ω across the pair (Q, /Q). See "LVDS Output Termination" subsection for more details.
8	VCC	Positive Power Supply: Bypass with 0.1μF//0.01μF low ESR capacitors as close to the V _{CC} pin as possible.

Absolute Maximum Ratings⁽¹⁾

Supply Voltage (V_{CC}) -0.5V to +4.0V
 Input Voltage (V_{IN}) -0.5V to $V_{CC} + 0.3V$
 LVDS Output Current (I_{OUT}) $\pm 10mA$
 Input Current
 Source or Sink Current on (IN, /IN) $\pm 50mA$
 Current (V_{REF})
 Source or sink current on V_{REF-AC} ⁽⁴⁾ $\pm 1.5mA$
 Maximum operating Junction Temperature 125°C
 Lead Temperature (soldering, 20sec.) 260°C
 Storage Temperature (T_s) -65°C to +150°C

Operating Ratings⁽²⁾

Supply Voltage (V_{IN}) +2.375V to +2.625V
 Ambient Temperature (T_A) -40°C to +85°C
 Package Thermal Resistance⁽³⁾
 DFN
 Still-air (θ_{JA}) 93°C/W
 Junction-to-board (ψ_{JB}) 56°C/W

DC Electrical Characteristics⁽⁵⁾

$T_A = -40^\circ C$ to $+85^\circ C$, unless otherwise stated.

Symbol	Parameter	Condition	Min	Typ	Max	Units
V_{CC}	Power Supply Voltage Range		2.375	2.5	2.625	V
I_{CC}	Power Supply Current	No load, max. V_{CC}		35	50	mA
R_{DIFF_IN}	Differential Input Resistance (IN-to-/IN)		90	100	110	Ω
V_{IH}	Input HIGH Voltage (IN, /IN)	IN, /IN	1.2		V_{CC}	V
V_{IL}	Input LOW Voltage (IN, /IN)	IN, /IN	0		$V_{IH}-0.1$	V
V_{IN}	Input Voltage Swing (IN, /IN)	see Figure 3a, Note 6	0.1		1.7	V
V_{DIFF_IN}	Differential Input Voltage Swing (IN - /IN)	see Figure 3b	0.2			V
V_{IN_FSI}	Input Voltage Threshold that Triggers FSI			30	100	mV
V_{REF-AC}	Output Reference Voltage		$V_{CC}-1.3$	$V_{CC}-1.2$	$V_{CC}-1.1$	V
V_{T_IN}	Voltage from Input to V_T				1.28	V

Notes:

1. Permanent device damage may occur if absolute maximum ratings are exceeded. This is a stress rating only and functional operation is not implied at conditions other than those detailed in the operational sections of this data sheet. Exposure to absolute maximum ratings conditions for extended periods may affect device reliability.
2. The data sheet limits are not guaranteed if the device is operated beyond the operating ratings.
3. Package thermal resistance assumes exposed pad is soldered (or equivalent) to the device's most negative potential on the PCB. ψ_{JB} and θ_{JA} values are determined for a 4-layer board in still-air number, unless otherwise stated.
4. Due to the limited drive capability, use for input of the same package only.
5. The circuit is designed to meet the DC specifications shown in the above table after thermal equilibrium has been established.
6. $V_{IN} (max)$ is specified when V_T is floating.

LVDS Output DC Electrical Characteristics⁽⁷⁾

$V_{CC} = +2.5V \pm 5\%$, $R_L = 100\Omega$ across the outputs; $T_A = -40^\circ\text{C}$ to $+85^\circ\text{C}$, unless otherwise stated.

Symbol	Parameter	Condition	Min	Typ	Max	Units
V_{OUT}	Output Voltage Swing	See Figure 3a	250	325		mV
V_{DIFF_OUT}	Differential Output Voltage Swing	See Figure 3b	500	650		mV
V_{OCM}	Output Common Mode Voltage		1.125	1.20	1.275	V
ΔV_{OCM}	Change in Common Mode Voltage		-50		50	mV

Note:

7. The circuit is designed to meet the DC specifications shown in the above table after thermal equilibrium has been established.

AC Electrical Characteristics

$V_{CC} = +2.5V \pm 5\%$, $R_L = 100\Omega$ across the outputs, Input $t_r/t_f: \leq 300ps$; $T_A = -40^\circ C$ to $+85^\circ C$, unless otherwise stated.

Symbol	Parameter	Condition	Min	Typ	Max	Units
f_{MAX}	Maximum Frequency	NRZ Data	3.2			Gbps
		$V_{OUT} > 200mV$ Clock	2.0	3		GHz
t_{PD}	Propagation Delay IN-to-Q	$V_{IN}: 100mV-200mV$	170	280	420	ps
		200mV-800mV	130	200	300	ps
t_{Skew}	Part-to-Part Skew	Note 8			135	ps
t_{Jitter}	Data Random Jitter	Note 9			1	$\mu SRMS$
	Deterministic Jitter	Note 10			10	μSPP
	Clock Cycle-to-Cycle Jitter	Note 11			1	$\mu SRMS$
	Total Jitter	Note 12			10	μSPP
t_r, t_f	Output Rise/Fall Times (20% to 80%)	At full output swing.	35	60	100	ps
	Duty Cycle	Differential I/O	47		53	%

Notes:

- Part-to-part skew is defined for two parts with identical power supply voltages at the same temperature and no skew at the edges at the respective inputs.
- Random jitter is measured with a K28.7 pattern, measured at $\leq f_{MAX}$.
- Deterministic jitter is measured at 2.5Gbps with both K28.5 and $2^{23}-1$ PRBS pattern.
- Cycle-to-cycle jitter definition: the variation period between adjacent cycles over a random sample of adjacent cycle pairs. $t_{JITTER_CC} = T_n - T_{n+1}$, where T is the time between rising edges of the output signal.
- Total jitter definition: with an ideal clock input frequency of $\leq f_{MAX}$ (device), no more than one output edge in 10^{12} output edges will deviate by more than the specified peak-to-peak jitter value.

Functional Description

Fail-Safe Input (FSI)

The input includes a special failsafe circuit to sense the amplitude of the input signal and to latch the outputs when there is no input signal present, or when the amplitude of the input signal drops sufficiently below 100mV_{PK} (200mV_{PP}), typically 30mV_{PK} . Maximum frequency of SY58605U is limited by the FSI function.

Input Clock Failure Case

If the input clock fails to a floating, static, or extremely low signal swing, the FSI function will then eliminate a metastable condition and guarantee a stable output. No ringing and no undetermined state will occur at the output under these conditions.

Note that the FSI function will not prevent duty cycle distortion in case of a slowly deteriorating (but still toggling) input signal. Due to the FSI function, the propagation delay will depend on rise and fall time of the input signal and on its amplitude. Refer to "Typical Characteristics" for detailed information.

Timing Diagrams

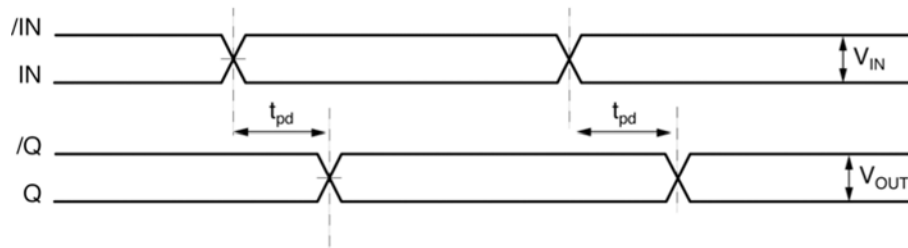

Figure 1a. Propagation Delay

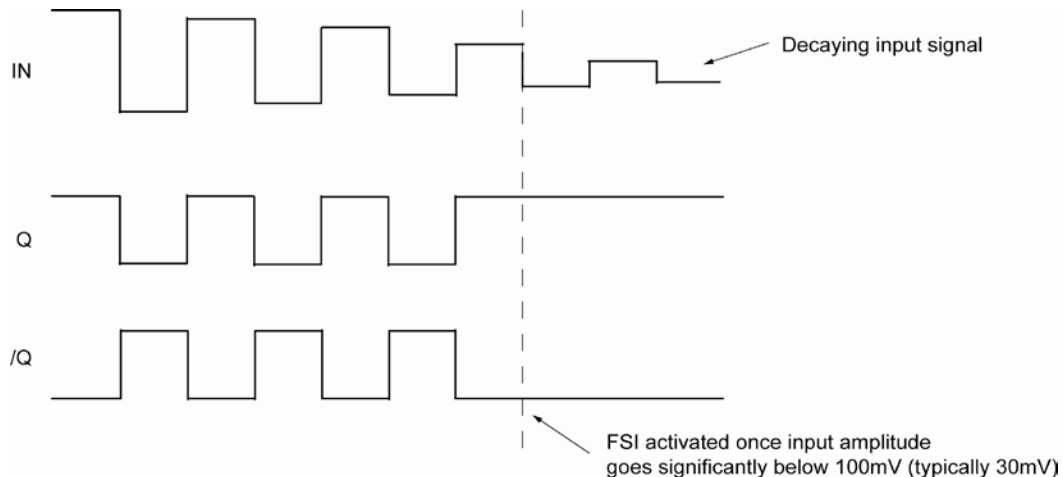
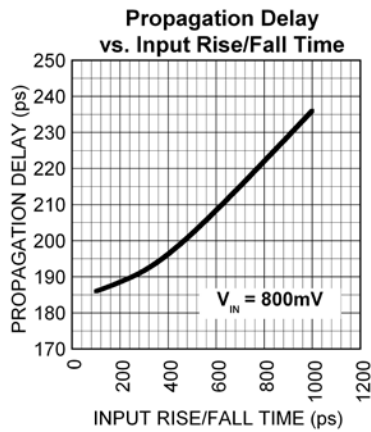
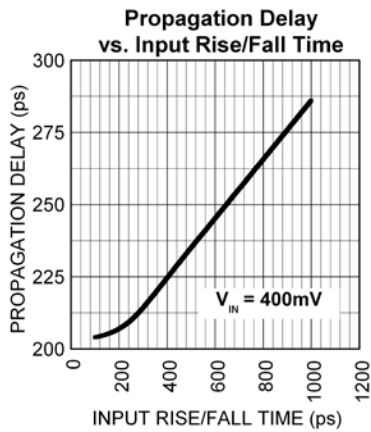
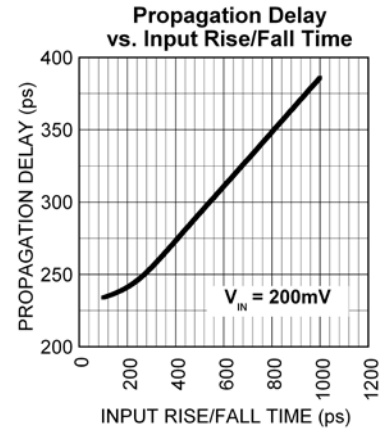
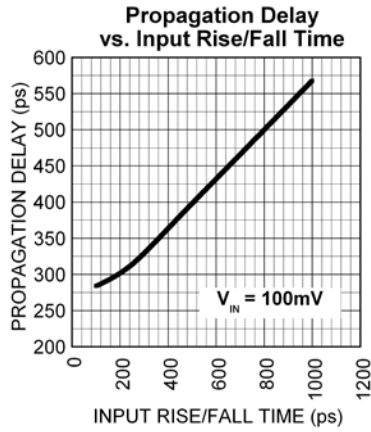
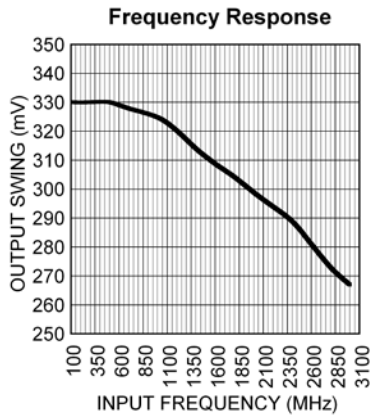

Figure 1b. Fail Safe Feature

Typical Characteristics

$V_{CC} = 2.5V$, $GND = 0V$, $V_{IN} = 100mV$, $R_L = 100\Omega$ across the outputs, $T_A = 25^\circ C$, unless otherwise stated.



Functional Characteristics

$V_{CC} = 2.5V$, $GND = 0V$, $V_{IN} = 250mV$, Data Pattern: $2^{23}-1$, $R_L = 100\Omega$ across the outputs, $T_A = 25^\circ C$, unless otherwise stated.

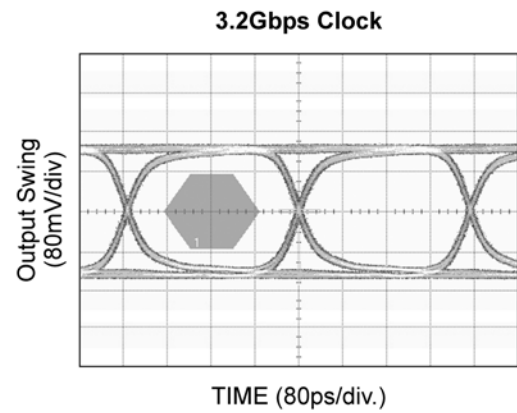
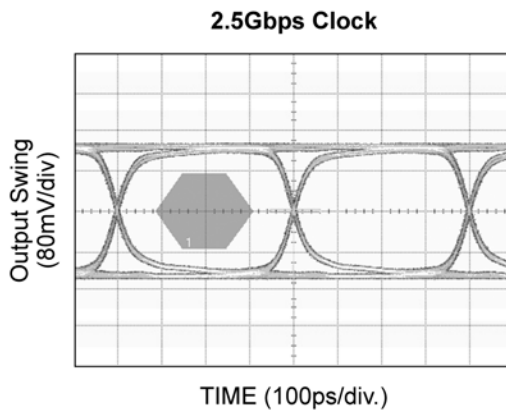
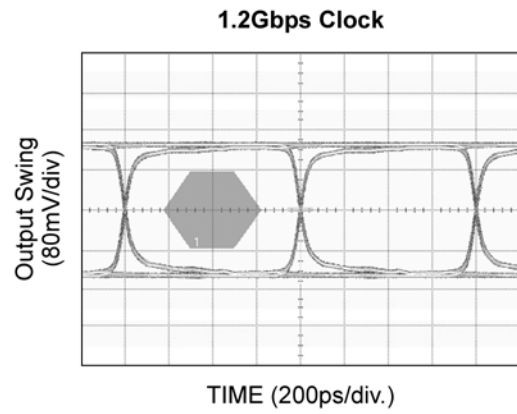
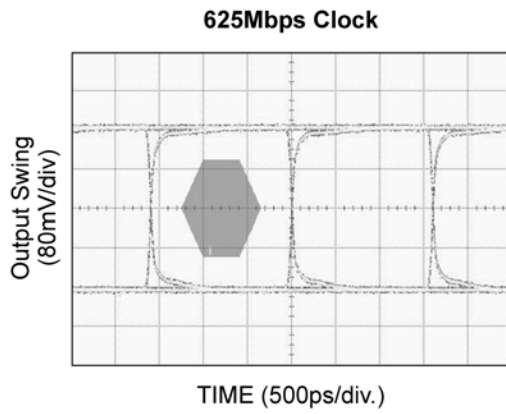

Functional Characteristics (continued)

$V_{CC} = 2.5V$, $GND = 0V$, $V_{IN} = 100mV$, $R_L = 100\Omega$ across the outputs, $T_A = 25^\circ C$, unless otherwise stated.

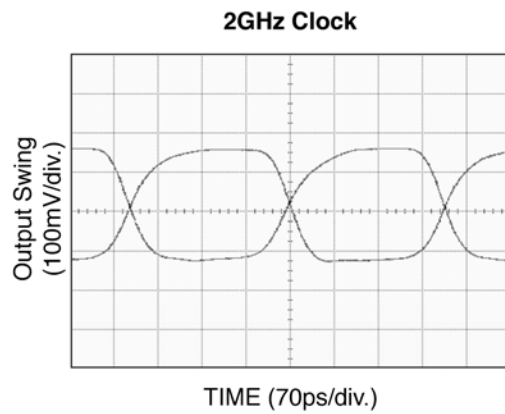
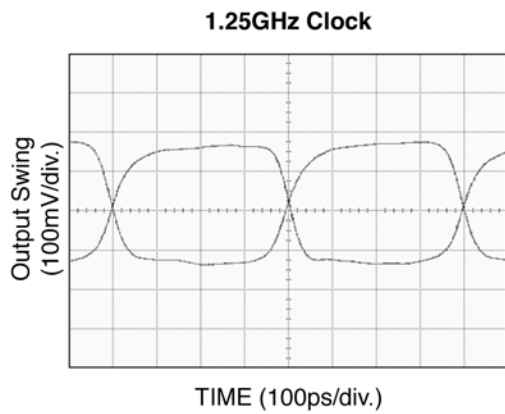
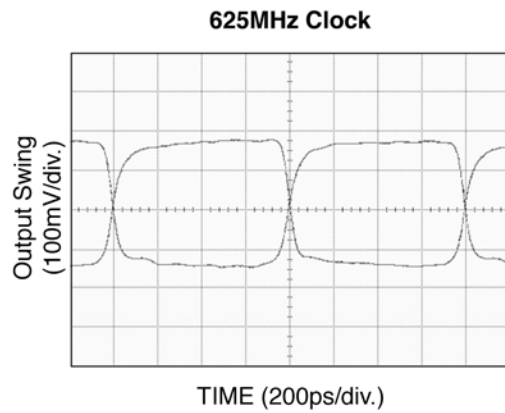
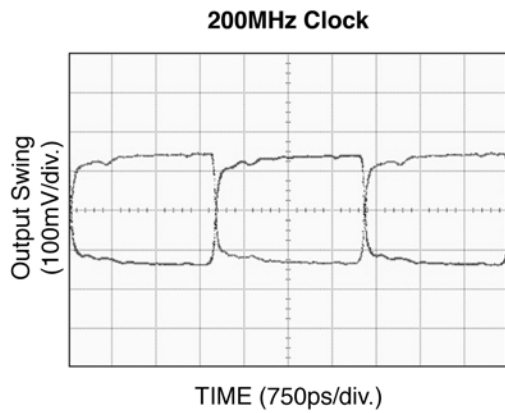

Input Stage

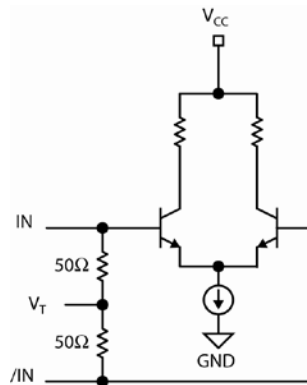

Figure 2. Simplified Differential Input Buffer

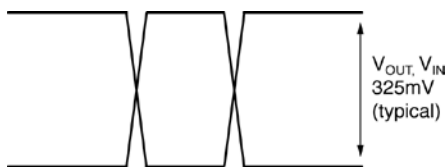

Figure 3a. Single-Ended Swing

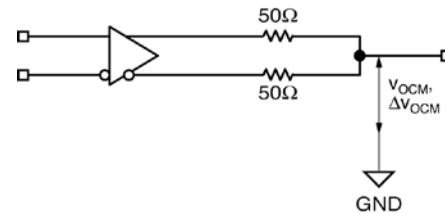

Figure 3c. LVDS Common Mode Measurement

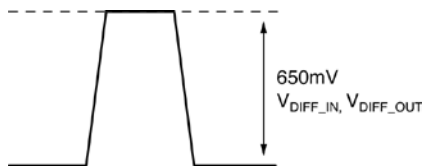

Figure 3b. Differential Swing

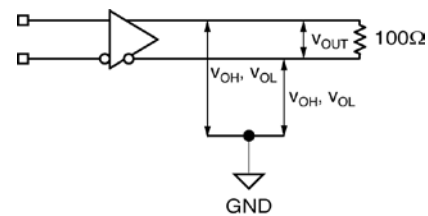

Figure 3d. LVDS Differential Measurement

Input Interface Applications

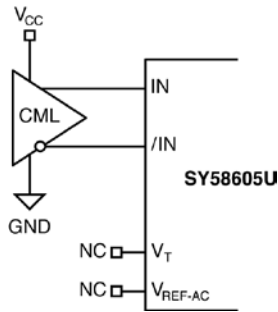

Figure 4a. CML Interface (DC-Coupled)

Option: May connect V_T to V_{CC}

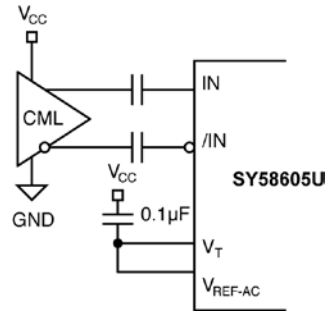

Figure 4b. CML Interface (AC-Coupled)

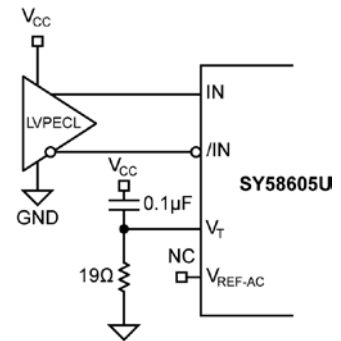

Figure 4c. LVPECL Interface (DC-Coupled)

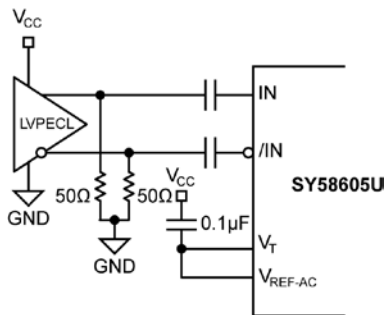

Figure 4d. LVPECL Interface (AC-Coupled)

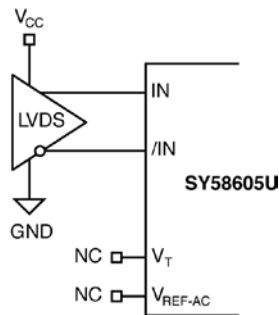
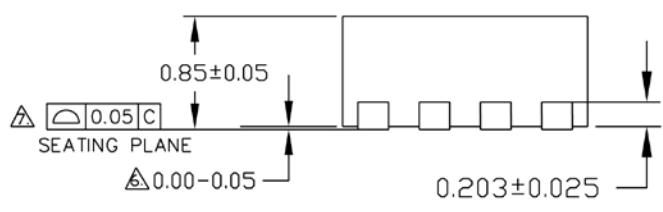
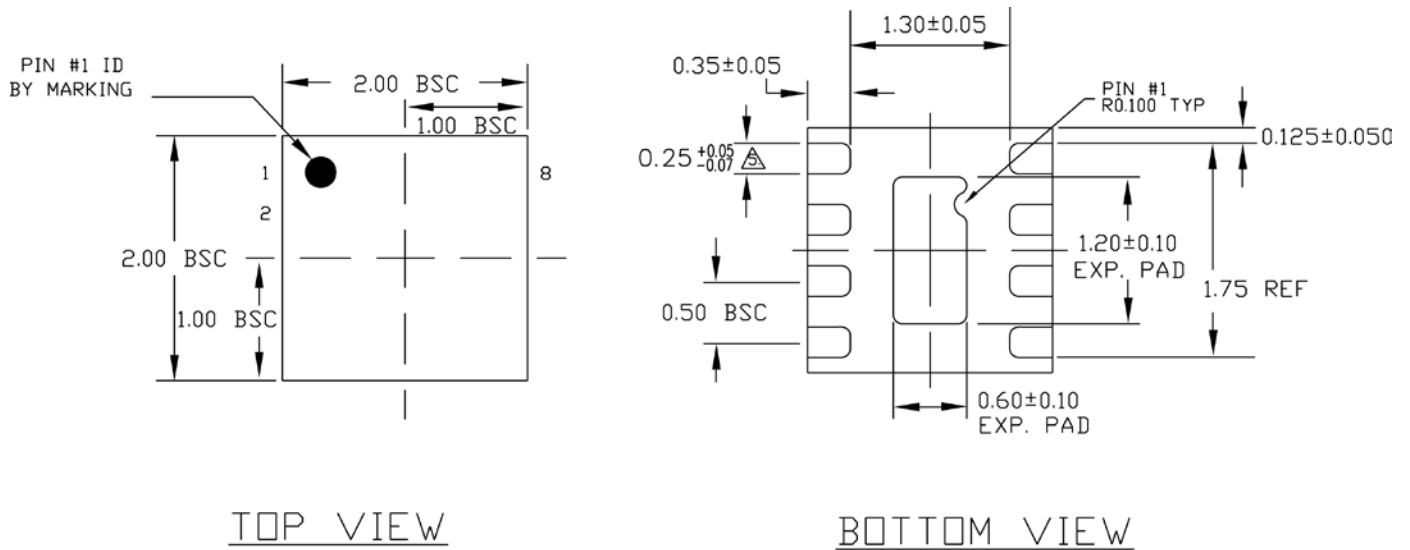

Figure 4e. LVDS Interface

Related Product and Support Documents

Part Number	Function	Data Sheet Link
SY58603U	4.25Gbps Precision CML Buffer with Internal Termination and Fail Safe Input	http://www.micrel.com/page.do?page=/product-info/products/sy58603u.shtml
SY58604U	3.2Gbps Precision LVPECL Buffer with Internal Termination and Fail Safe Input	http://www.micrel.com/page.do?page=/product-info/products/sy58604u.shtml
HBW Solutions	New Products and Termination Application Notes	http://www.micrel.com/page.do?page=/product-info/as/HBWsolutions.shtml

Package Information



- NOTE:
1. ALL DIMENSIONS ARE IN MILLIMETERS.
 2. MAX. PACKAGE WARPAGE IS 0.05 mm.
 3. MAXIMUM ALLOWABLE BURRS IS 0.076 mm IN ALL DIRECTIONS.
 4. PIN #1 ID ON TOP WILL BE LASER/INK MARKED.
- DIMENSION APPLIES TO METALIZED TERMINAL AND IS MEASURED BETWEEN 0.20 AND 0.25 mm FROM TERMINAL TIP.
 APPLIED ONLY FOR TERMINALS.
 APPLIED FOR EXPOSED PAD AND TERMINALS.

SIDE VIEW

8-Pin (2mm x 2mm) DFN

MICREL, INC. 2180 FORTUNE DRIVE SAN JOSE, CA 95131 USA
 TEL +1 (408) 944-0800 FAX +1 (408) 474-1000 WEB <http://www.micrel.com>

The information furnished by Micrel in this data sheet is believed to be accurate and reliable. However, no responsibility is assumed by Micrel for its use. Micrel reserves the right to change circuitry and specifications at any time without notification to the customer.

Micrel Products are not designed or authorized for use as components in life support appliances, devices or systems where malfunction of a product can reasonably be expected to result in personal injury. Life support devices or systems are devices or systems that (a) are intended for surgical implant into the body or (b) support or sustain life, and whose failure to perform can be reasonably expected to result in a significant injury to the user. A Purchaser's use or sale of Micrel Products for use in life support appliances, devices or systems is a Purchaser's own risk and Purchaser agrees to fully indemnify Micrel for any damages resulting from such use or sale.

© 2006 Micrel, Incorporated.

Mouser Electronics

Authorized Distributor

Click to View Pricing, Inventory, Delivery & Lifecycle Information:

[Micrel:](#)

[SY58605UMG TR](#) [SY58605UMG-TR](#)

Данный компонент на территории Российской Федерации

Вы можете приобрести в компании MosChip.

Для оперативного оформления запроса Вам необходимо перейти по данной ссылке:

<http://moschip.ru/get-element>

Вы можете разместить у нас заказ для любого Вашего проекта, будь то серийное производство или разработка единичного прибора.

В нашем ассортименте представлены ведущие мировые производители активных и пассивных электронных компонентов.

Нашей специализацией является поставка электронной компонентной базы двойного назначения, продукции таких производителей как XILINX, Intel (ex.ALTERA), Vicor, Microchip, Texas Instruments, Analog Devices, Mini-Circuits, Amphenol, Glenair.

Сотрудничество с глобальными дистрибьюторами электронных компонентов, предоставляет возможность заказывать и получать с международных складов практически любой перечень компонентов в оптимальные для Вас сроки.

На всех этапах разработки и производства наши партнеры могут получить квалифицированную поддержку опытных инженеров.

Система менеджмента качества компании отвечает требованиям в соответствии с ГОСТ Р ИСО 9001, ГОСТ РВ 0015-002 и ЭС РД 009

Офис по работе с юридическими лицами:

105318, г.Москва, ул.Щербаковская д.3, офис 1107, 1118, ДЦ «Щербаковский»

Телефон: +7 495 668-12-70 (многоканальный)

Факс: +7 495 668-12-70 (доб.304)

E-mail: info@moschip.ru

Skype отдела продаж:

moschip.ru

moschip.ru_4

moschip.ru_6

moschip.ru_9