

Dual 50MHz to 1000MHz High-Linearity, Serial/Parallel-Controlled Analog/Digital VGA

General Description

The MAX2062 high-linearity, dual analog/digital variable-gain amplifier (VGA) operates in the 50MHz to 1000MHz frequency range with two independent attenuators in each signal path. Each digital attenuator is controlled as a slave peripheral using either the SPI-compatible interface, or a 5-bit parallel bus with 31dB total adjustment range in 1dB steps. An added feature allows rapid-fire gain selection among each of the four steps, preprogrammed by the user through the SPI-compatible interface. A separate 2-pin control lets the user quickly access any one of four customized attenuation states without reprogramming the SPI bus. Each analog attenuator is controlled using an external voltage or through the SPI-compatible interface using an on-chip 8-bit DAC.

Since each of the stages has its own external RF input and RF output, this component can be configured to either optimize noise figure (NF) (amplifier configured first), OIP3 (amplifier last), or a compromise of NF and OIP3. The device's performance features include 24dB amplifier gain (amplifier only), 7.3dB NF at maximum gain (includes attenuator insertion losses), and a high OIP3 level of +41dBm. Each of these features makes the device an ideal VGA for multipath receiver and transmitter applications.

In addition, the device operates from a single +5V supply with full performance or a +3.3V supply for an enhanced power-savings mode with lower performance. The device is available in a compact 48-pin TQFN package (7mm x 7mm) with an exposed pad. Electrical performance is guaranteed over the extended temperature range, from $T_C = -40^\circ\text{C}$ to $+85^\circ\text{C}$.

Applications

IF and RF Gain Stages
 Temperature-Compensation Circuits
 GSM/EDGE Base Stations
 WCDMA, TD-SCDMA, and cdma2000® Base Stations
 WiMAX®, LTE, and TD-LTE Base Stations and Customer-Premise Equipment
 Fixed Broadband Wireless Access
 Wireless Local Loop

Features

- ◆ Independently Controlled Dual Paths
- ◆ 50MHz to 1000MHz RF Frequency Range
- ◆ Pin-Compatible Family Includes
 MAX2063 (Digital-Only VGA)
 MAX2064 (Analog-Only VGA)
- ◆ 19.4dB (typ) Maximum Gain
- ◆ 0.34dB Gain Flatness Over 100MHz Bandwidth
- ◆ 64dB Gain Range (33dB Analog Plus 31dB Digital)
- ◆ 56dB Path Isolation (at 200MHz)
- ◆ Built-In 8-Bit DACs for Analog Attenuation Control
- ◆ Supports Four Rapid-Fire Preprogrammed Attenuator States
 Quickly Access Any One of Four Customized Attenuator States
 Ideal for Fast-Attack, High-Level Blocker Protection
 Protects ADC Overdrive Condition
- ◆ Excellent Linearity (Configured with Amp Last at 200MHz)
 +41dBm OIP3
 +56dBm OIP2
 +19dBm Output 1dB Compression Point
- ◆ 7.3dB Typical Noise Figure (at 200MHz)
- ◆ Fast, 25ns Digital Switching
- ◆ Very Low Digital VGA Amplitude Overshoot/Undershoot
- ◆ Single +5V Supply (or +3.3V Operation)
- ◆ Amplifier Power-Down Mode for TDD Applications

Ordering Information

PART	TEMP RANGE	PIN-PACKAGE
MAX2062ETM+	-40°C to +85°C	48 TQFN-EP*
MAX2062ETM+T	-40°C to +85°C	48 TQFN-EP*

+ Denotes lead(Pb)-free/RoHS-compliant package.

*EP = Exposed pad.

T = Tape and reel.

cdma2000 is a registered certification mark and registered service mark of the Telecommunications Industry Association.

WiMAX is a registered certification mark and registered service mark of the WiMAX Forum.

MAX2062

Dual 50MHz to 1000MHz High-Linearity, Serial/Parallel-Controlled Analog/Digital VGA

ABSOLUTE MAXIMUM RATINGS

VCC_AMP_1, VCC_AMP_2, VCC_RG to GND	-0.3V to +5.5V	REG_OUT to GND	-0.3V to +3.6V
STA_A_1, STA_A_2, STA_B_1, STA_B_2,		RF Input Power (D_ATT_IN_1, D_ATT_IN_2)	+20dBm
PD_1, PD_2, AMPSET to GND	-0.3V to +3.6V	RF Input Power (A_ATT_IN_1, A_ATT_IN_2)	+20dBm
A_VCTL_1, A_VCTL_2 to GND	-0.3V to +3.6V	RF Input Power (AMP_IN_1, AMP_IN_2)	+18dBm
DAT, CS, CLK, AA_SP, DA_SP to GND	-0.3V to +3.6V	θ_{JC} (Notes 1, 2)	+12.3°C/W
D0_1, D1_1, D2_1, D3_1, D4_1, D0_2, D1_2,		θ_{JA} (Notes 2, 3)	+38°C/W
D2_2, D3_2, D4_2 to GND	-0.3V to +3.6V	Continuous Power Dissipation (Note 1)	5.3W
AMP_IN_1, AMP_IN_2 to GND	+0.95V to +1.2V	Operating Case Temperature Range (Note 4)	-40°C to +85°C
AMP_OUT_1, AMP_OUT_2 to GND	-0.3V to +5.5V	Junction Temperature	+150°C
D_ATT_IN_1, D_ATT_IN_2, D_ATT_OUT_1,		Storage Temperature Range	-65°C to +150°C
D_ATT_OUT_2 to GND	0V to +3.6V	Lead Temperature (soldering, 10s)	+300°C
A_ATT_IN_1, A_ATT_IN_2, A_ATT_OUT_1,		Soldering Temperature (reflow)	+260°C
A_ATT_OUT_2 to GND	0V to +3.6V		

Note 1: Based on junction temperature $T_J = T_C + (\theta_{JC} \times V_{CC} \times I_{CC})$. This formula can be used when the temperature of the exposed pad is known while the device is soldered down to a PCB. See the *Applications Information* section for details. The junction temperature must not exceed +150°C.

Note 2: Package thermal resistances were obtained using the method described in JEDEC specification JESD51-7, using a four-layer board. For detailed information on package thermal considerations, refer to www.maximintegrated.com/thermal-tutorial.

Note 3: Junction temperature $T_J = T_A + (\theta_{JA} \times V_{CC} \times I_{CC})$. This formula can be used when the ambient temperature of the PCB is known. The junction temperature must not exceed +150°C.

Note 4: T_C is the temperature on the exposed pad of the package. T_A is the ambient temperature of the device and PCB.

Stresses beyond those listed under "Absolute Maximum Ratings" may cause permanent damage to the device. These are stress ratings only, and functional operation of the device at these or any other conditions beyond those indicated in the operational sections of the specifications is not implied. Exposure to absolute maximum rating conditions for extended periods may affect device reliability.

5.0V SUPPLY DC ELECTRICAL CHARACTERISTICS

(Typical Application Circuit, $V_{CC} = V_{CC_AMP_1} = V_{CC_AMP_2} = V_{CC_RG} = 4.75V$ to $5.25V$, $AMPSET = 0$, $PD_1 = PD_2 = 0$, $T_C = -40^\circ C$ to $+85^\circ C$. Typical values are at $V_{CC} = 5.0V$ and $T_C = +25^\circ C$, unless otherwise noted.)

PARAMETER	SYMBOL	CONDITIONS	MIN	TYP	MAX	UNITS
Supply Voltage	V_{CC}		4.75	5	5.25	V
Supply Current	I_{DC}			148	210	mA
Power-Down Current	I_{DCPD}	$PD_1 = PD_2 = 1, V_{IH} = 3.3V$		5.3	8	mA
Logic-Low Input Voltage	V_{IL}				0.5	V
Logic-High Input Voltage	V_{IH}		1.7		3.465	V
Input Logic Current	I_{IH}, I_{IL}		-1		+1	μA

3.3V SUPPLY DC ELECTRICAL CHARACTERISTICS

(Typical Application Circuit, $V_{CC} = V_{CC_AMP_1} = V_{CC_AMP_2} = V_{CC_RG} = 3.135V$ to $3.465V$, $AMPSET = 1$, $PD_1 = PD_2 = 0$, $T_C = -40^\circ C$ to $+85^\circ C$. Typical values are at $V_{CC} = 3.3V$ and $T_C = +25^\circ C$, unless otherwise noted.)

PARAMETER	SYMBOL	CONDITIONS	MIN	TYP	MAX	UNITS
Supply Voltage	V_{CC}		3.135	3.3	3.465	V
Supply Current	I_{DC}			87	145	mA
Power-Down Current	I_{DCPD}	$PD_1 = PD_2 = 1, V_{IH} = 3.3V$		4.5	8	mA
Logic-Low Input Voltage	V_{IL}				0.5	V
Logic-High Input Voltage	V_{IH}		1.7			V

Dual 50MHz to 1000MHz High-Linearity, Serial/Parallel-Controlled Analog/Digital VGA

RECOMMENDED AC OPERATING CONDITIONS

PARAMETER	SYMBOL	CONDITIONS	MIN	TYP	MAX	UNITS
RF Frequency	f_{RF}	(Note 5)	50		1000	MHz

5.0V SUPPLY AC ELECTRICAL CHARACTERISTICS (Each Path, Unless Otherwise Noted)

(Typical Application Circuit, $V_{CC} = V_{CC_AMP_1} = V_{CC_AMP_2} = V_{CC_RG} = 4.75V$ to $5.25V$, attenuators are set for maximum gain, RF ports are driven from 50Ω sources, $AMPSET = 0$, $PD_1 = PD_2 = 0$, $100MHz \leq f_{RF} \leq 500MHz$, $T_C = -40^\circ C$ to $+85^\circ C$. Typical values are at maximum gain setting, $V_{CC_} = 5.0V$, $P_{IN} = -20dBm$, $f_{RF} = 350MHz$, and $T_C = +25^\circ C$, unless otherwise noted.) (Note 6)

PARAMETER	SYMBOL	CONDITIONS	MIN	TYP	MAX	UNITS
Small-Signal Gain	G	$f_{RF} = 50MHz$		20.3		dB
		$f_{RF} = 100MHz$		19.9		
		$f_{RF} = 200MHz$		19.4		
		$f_{RF} = 350MHz$, $T_C = +25^\circ C$	17.0	18.9	21.0	
		$f_{RF} = 450MHz$		18.6		
		$f_{RF} = 750MHz$		17.8		
		$f_{RF} = 900MHz$		16.5		
Gain vs. Temperature				-0.01		dB/ $^\circ C$
Gain Flatness vs. Frequency		From 100MHz to 200MHz		0.5		dB
		Any 100MHz frequency band from 200MHz to 500MHz		0.34		
Noise Figure	NF	$f_{RF} = 50MHz$		6.4		dB
		$f_{RF} = 100MHz$		6.8		
		$f_{RF} = 200MHz$		7.3		
		$f_{RF} = 350MHz$		7.6		
		$f_{RF} = 450MHz$		7.8		
		$f_{RF} = 750MHz$		8.7		
		$f_{RF} = 900MHz$		9.0		
Total Attenuation Range		Analog and digital combined		64.1		dB
Output Second-Order Intercept Point	OIP2	$P_{OUT} = 0dBm/$ tone, $\Delta f = 1MHz$, $f_1 + f_2$		52.1		dBm
Path Isolation		RF input 1 amplified power measured at RF output 2 relative to RF output 1, all unused ports terminated to 50Ω		48.6		dB
		RF input 2 amplified signal measured at RF output 1 relative to RF output 2, all unused ports terminated to 50Ω		47.7		
Output Third-Order Intercept Point	OIP3	$P_{OUT} = 0dBm/$ tone, $\Delta f = 1MHz$, $f_{RF} = 50MHz$		47.5		dBm
		$P_{OUT} = 0dBm/$ tone, $\Delta f = 1MHz$, $f_{RF} = 100MHz$		43.4		
		$P_{OUT} = 0dBm/$ tone, $\Delta f = 1MHz$, $f_{RF} = 200MHz$		41.3		
		$P_{OUT} = 0dBm/$ tone, $\Delta f = 1MHz$, $f_{RF} = 350MHz$		37.4		
		$P_{OUT} = 0dBm/$ tone, $\Delta f = 1MHz$, $f_{RF} = 450MHz$		35.1		
		$P_{OUT} = 0dBm/$ tone, $\Delta f = 1MHz$, $f_{RF} = 750MHz$		28.8		
		$P_{OUT} = 0dBm/$ tone, $\Delta f = 1MHz$, $f_{RF} = 900MHz$		25.8		
Output -1dB Compression Point	P1dB	$f_{RF} = 350MHz$, $T_C = +25^\circ C$ (Note 7)	17	18.8		dBm

MAX2062

Dual 50MHz to 1000MHz High-Linearity, Serial/Parallel-Controlled Analog/Digital VGA

5.0V SUPPLY AC ELECTRICAL CHARACTERISTICS (Each Path, Unless Otherwise Noted) (continued)

(Typical Application Circuit, $V_{CC} = V_{CC_AMP_1} = V_{CC_AMP_2} = V_{CC_RG} = 4.75V$ to $5.25V$, attenuators are set for maximum gain, RF ports are driven from 50Ω sources, $AMPSET = 0$, $PD_1 = PD_2 = 0$, $100MHz \leq f_{RF} \leq 500MHz$, $T_C = -40^\circ C$ to $+85^\circ C$. Typical values are at maximum gain setting, $V_{CC_} = 5.0V$, $P_{IN} = -20dBm$, $f_{RF} = 350MHz$, and $T_C = +25^\circ C$, unless otherwise noted.) (Note 6)

PARAMETER	SYMBOL	CONDITIONS	MIN	TYP	MAX	UNITS
Second Harmonic		$P_{OUT} = +3dBm$		-55.0		dBc
Third Harmonic		$P_{OUT} = +3dBm$		-72.7		dBc
Group Delay		Includes EV kit PCB delays		1.03		ns
Amplifier Power-Down Time		PD_1 or PD_2 from 0 to 1, amplifier DC supply current settles to within 0.1mA		0.5		μs
Amplifier Power-Up Time		PD_1 or PD_2 from 1 to 0, amplifier DC supply current settles to within 1%		0.5		μs
Input Return Loss	RL _{IN}	50Ω source		16.1		dB
Output Return Loss	RL _{OUT}	50Ω load		30.8		dB
DIGITAL ATTENUATOR (Each Path, Unless Otherwise Noted)						
Insertion Loss				3.0		dB
Input Second-Order Intercept Point		$P_{IN1} = 0dBm$, $P_{IN2} = 0dBm$ (minimum attenuation), $\Delta f = 1MHz$, $f_1 + f_2$		53.6		dBm
Input Third-Order Intercept Point		$P_{IN1} = 0dBm$, $P_{IN2} = 0dBm$ (minimum attenuation), $\Delta f = 1MHz$		41.5		dBm
Attenuation Range		$f_{RF} = 350MHz$, $T_C = +25^\circ C$, $V_{CC} = 5.0V$	29.5	30.9		dB
Step Size				1		dB
Relative Attenuation Accuracy				0.13		dB
Absolute Attenuation Accuracy				0.14		dB
Insertion Phase Step		$f_{RF} = 170MHz$	0dB to 16dB	0		Degrees
			0dB to 24dB	1.1		
			0dB to 31dB	1.2		
Amplitude Overshoot/Undershoot		Between any two states	Elapsed time = 15ns	1.0		dB
			Elapsed time = 40ns	0.05		
Switching Speed		RF settled to within $\pm 0.1dB$	31dB to 0dB	25		ns
			0dB to 31dB	21		
Input Return Loss		50Ω source		22.0		dB
Output Return Loss		50Ω load		21.9		dB
ANALOG ATTENUATOR (Each Path, Unless Otherwise Noted)						
Insertion Loss				2.2		dB
Input Second-Order Intercept Point		$P_{IN1} = 0dBm$, $P_{IN2} = 0dBm$ (minimum attenuation), $\Delta f = 1MHz$, $f_1 + f_2$		61.9		dBm
Input Third-Order Intercept Point		$P_{IN1} = 0dBm$, $P_{IN2} = 0dBm$ (minimum attenuation), $\Delta f = 1MHz$		37.0		dBm

Dual 50MHz to 1000MHz High-Linearity, Serial/Parallel-Controlled Analog/Digital VGA

5.0V SUPPLY AC ELECTRICAL CHARACTERISTICS (Each Path, Unless Otherwise Noted) (continued)

(Typical Application Circuit, $V_{CC} = V_{CC_AMP_1} = V_{CC_AMP_2} = V_{CC_RG} = 4.75V$ to $5.25V$, attenuators are set for maximum gain, RF ports are driven from 50Ω sources, $AMPSET = 0$, $PD_1 = PD_2 = 0$, $100MHz \leq f_{RF} \leq 500MHz$, $T_C = -40^\circ C$ to $+85^\circ C$. Typical values are at maximum gain setting, $V_{CC_} = 5.0V$, $P_{IN} = -20dBm$, $f_{RF} = 350MHz$, and $T_C = +25^\circ C$, unless otherwise noted.) (Note 6)

PARAMETER	SYMBOL	CONDITIONS	MIN	TYP	MAX	UNITS
Attenuation Range		$f_{RF} = 350MHz$, $T_C = +25^\circ C$, $V_{CC} = 5.0V$	29.5	33.2		dB
Gain Control Slope		Analog control input		-13.3		dB/V
Maximum Gain Control Slope		Over analog control input range		-35.2		dB/V
Insertion Phase Change		Over analog control input range		17.6		Deg
Attenuator Response Time		RF settled to within $\pm 0.5dB$	AA_SP = 0, $V_{A_VCTL_}$ from 2.75V to 0.25V	500		ns
			AA_SP = 1, DAC code from 11111111 to 00000000, from \overline{CS} rising edge	500		
			AA_SP = 0, $V_{A_VCTL_}$ from 0.25V to 2.75V	500		
			AA_SP = 1, DAC code from 00000000 to 11111111, from \overline{CS} rising edge	500		
Group Delay vs. Control Voltage		Over analog control input from 0.25V to 2.75V		-0.34		ns
Analog Control Input Range			0.25		2.75	V
Analog Control Input Impedance				19.2		k Ω
Input Return Loss		50Ω source		16.1		dB
Output Return Loss		50Ω load		16.8		dB
D/A CONVERTER						
Number of Bits				8		Bits
Output Voltage		DAC code = 00000000			0.35	V
		DAC code = 11111111		2.7		
SERIAL PERIPHERAL INTERFACE (SPI)						
Maximum Clock Speed				20		MHz
Data-to-Clock Setup Time	tCS			2		ns
Data-to-Clock Hold Time	tCH			2.5		ns
Clock-to- \overline{CS} Setup Time	tES			3		ns
\overline{CS} Positive Pulse Width	tEW			7		ns
\overline{CS} Setup Time	tEWS			3.5		ns
Clock Pulse Width	tCW			5		ns

MAX2062

Dual 50MHz to 1000MHz High-Linearity, Serial/Parallel-Controlled Analog/Digital VGA

3.3V SUPPLY AC ELECTRICAL CHARACTERISTICS (Each Path, Unless Otherwise Noted)

(Typical Application Circuit, $V_{CC} = V_{CC_AMP_1} = V_{CC_AMP_2} = V_{CC_RG} = 3.135V$ to $3.465V$, attenuators are set for maximum gain, RF ports are driven from 50Ω sources, $AMPSET = 1$, $PD_1 = PD_2 = 0$, $100MHz \leq f_{RF} \leq 500MHz$, $T_C = -40^\circ C$ to $+85^\circ C$. Typical values are at maximum gain setting, $V_{CC_} = 3.3V$, $P_{IN} = -20dBm$, $f_{RF} = 350MHz$, and $T_C = +25^\circ C$, unless otherwise noted.) (Note 6)

PARAMETER	SYMBOL	CONDITIONS	MIN	TYP	MAX	UNITS
Small-Signal Gain				18.8		dB
Output Third-Order Intercept Point	OIP3	$P_{OUT} = 0dBm/$ tone		29.4		dBm
Noise Figure				7.8		dB
Total Attenuation Range				64.1		dB
Path Isolation		RF input 1 amplified power measured at RF output 2 relative to RF output 1, all unused ports terminated to 50Ω		49.1		dB
		RF input 2 amplified signal measured at RF output 1 relative to RF output 2, all unused ports terminated to 50Ω		48.0		
Output -1dB Compression Point	P_{1dB}	(Note 7)		13.4		dBm

Note 5: Operation outside this range is possible, but with degraded performance of some parameters. See the *Typical Operating Characteristics* section.

Note 6: All limits include external component losses. Output measurements are performed at the RF output port of the *Typical Application Circuit*.

Note 7: It is advisable not to continuously operate the RF input 1 or RF input 2 above +15dBm.

Typical Operating Characteristics

(Typical Application Circuit, $V_{CC} = V_{CC_AMP_1} = V_{CC_AMP_2} = V_{CC_RG} = 5.0V$, attenuators are set for maximum gain, RF ports are driven from 50Ω sources, $AMPSET = 0$, $PD_1 = PD_2 = 0$, $P_{IN} = -20dBm$, $f_{RF} = 350MHz$, and $T_C = +25^\circ C$, unless otherwise noted.)

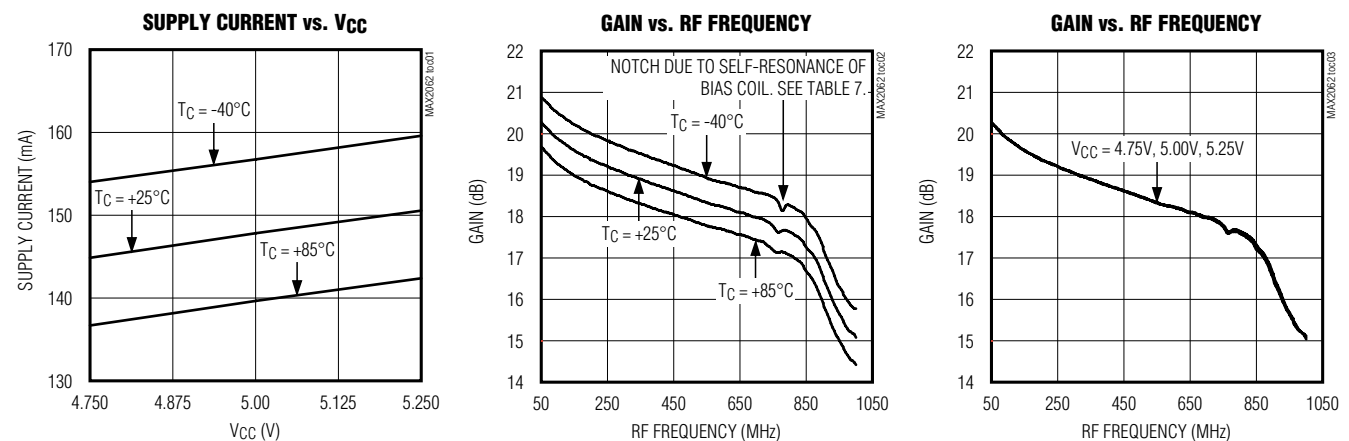

Dual 50MHz to 1000MHz High-Linearity, Serial/Parallel-Controlled Analog/Digital VGA

Typical Operating Characteristics (continued)

(Typical Application Circuit, $V_{CC} = V_{CC_AMP_1} = V_{CC_AMP_2} = V_{CC_RG} = 5.0V$, attenuators are set for maximum gain, RF ports are driven from 50Ω sources, $AMPSET = 0$, $PD_1 = PD_2 = 0$, $P_{IN} = -20dBm$, $f_{RF} = 350MHz$, and $T_C = +25^\circ C$, unless otherwise noted.)

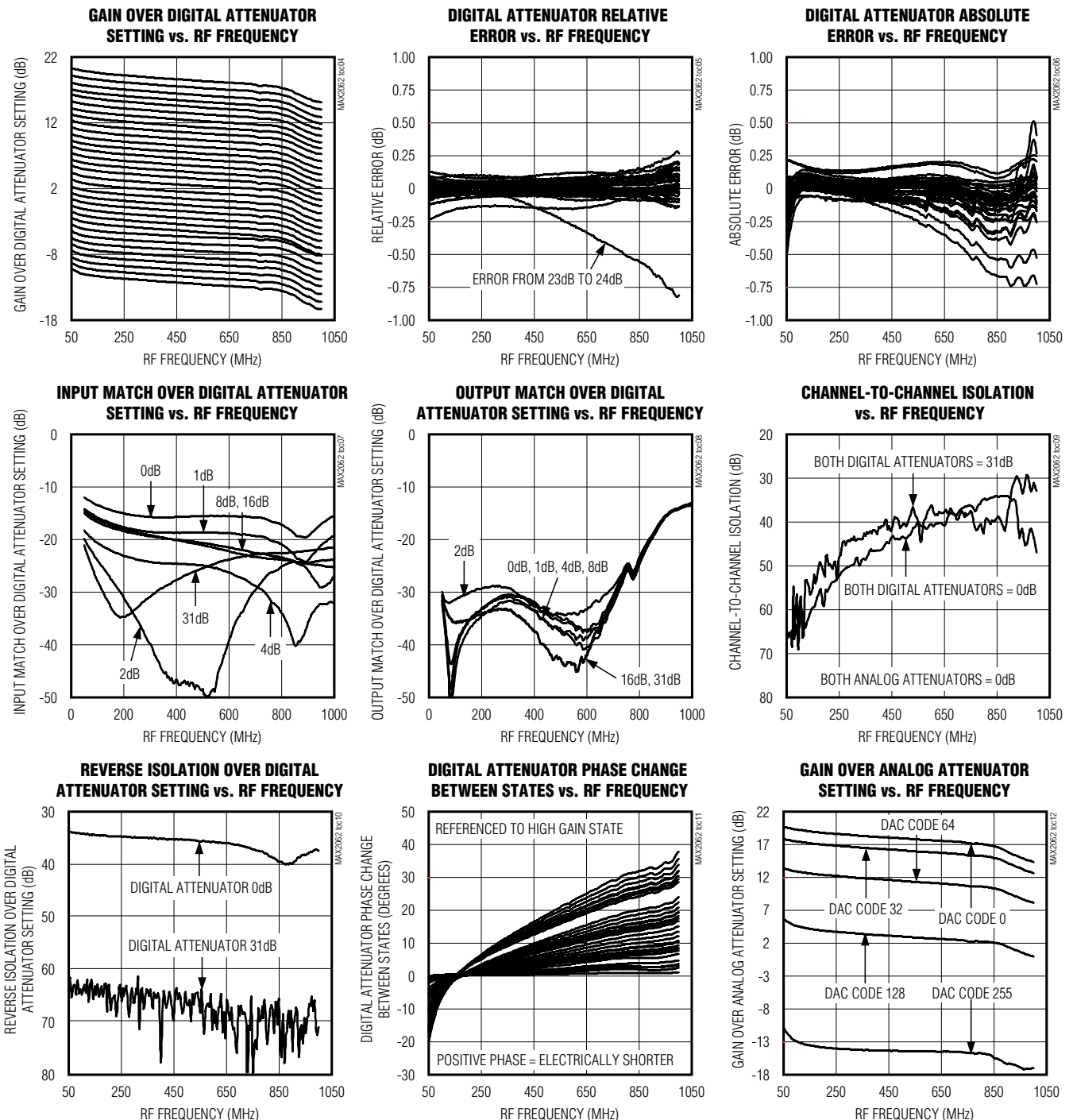

MAX2062

Dual 50MHz to 1000MHz High-Linearity, Serial/Parallel-Controlled Analog/Digital VGA

Typical Operating Characteristics (continued)

(Typical Application Circuit, $V_{CC} = V_{CC_AMP_1} = V_{CC_AMP_2} = V_{CC_RG} = 5.0V$, attenuators are set for maximum gain, RF ports are driven from 50Ω sources, AMPSET = 0, PD₁ = PD₂ = 0, P_{IN} = -20dBm, $f_{RF} = 350MHz$, and $T_C = +25^\circ C$, unless otherwise noted.)

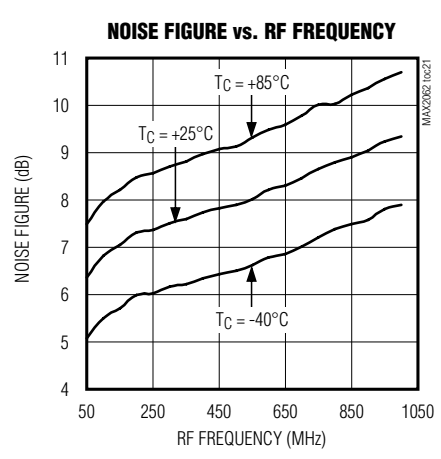
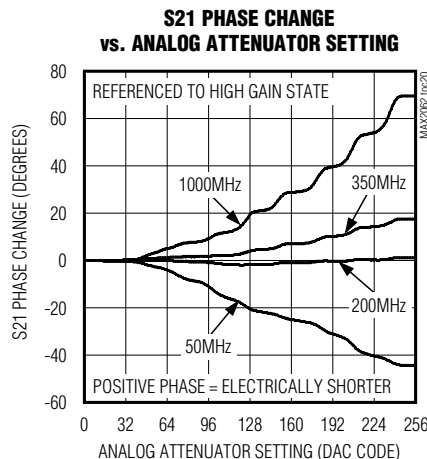
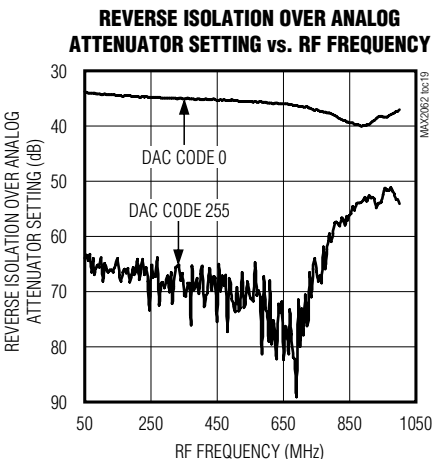
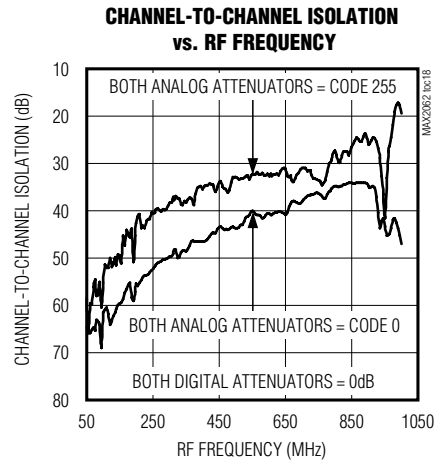
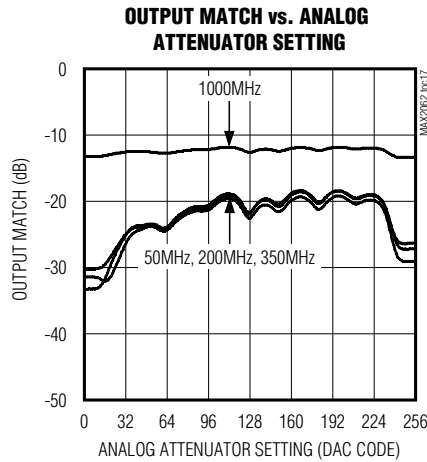
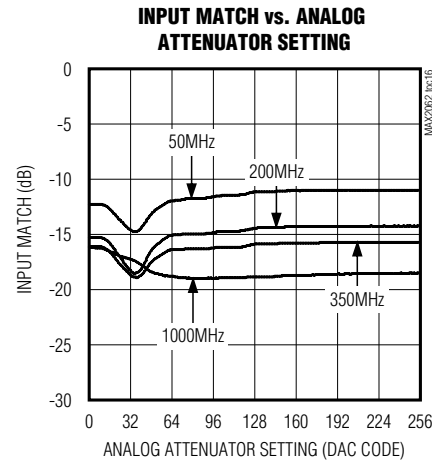
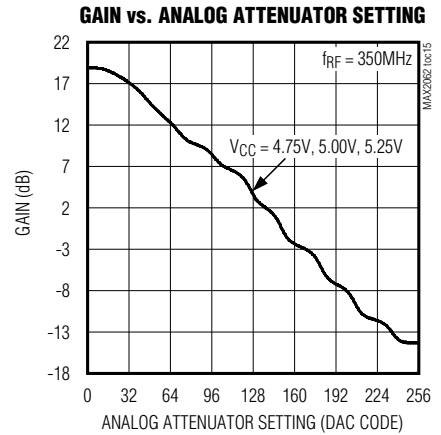
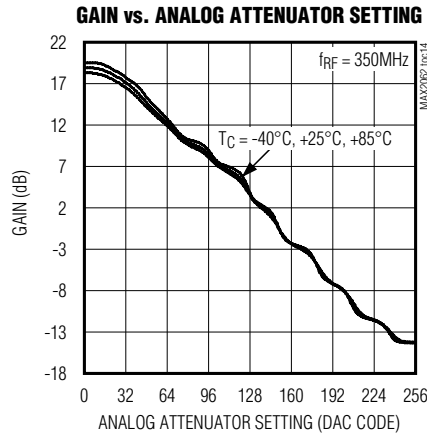
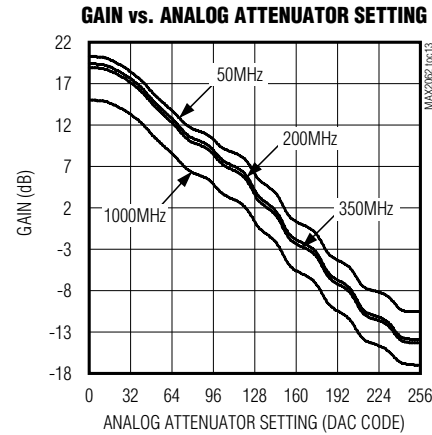

Dual 50MHz to 1000MHz High-Linearity, Serial/Parallel-Controlled Analog/Digital VGA

Typical Operating Characteristics (continued)

(Typical Application Circuit, $V_{CC} = V_{CC_AMP_1} = V_{CC_AMP_2} = V_{CC_RG} = 5.0V$, attenuators are set for maximum gain, RF ports are driven from 50Ω sources, $AMPSET = 0$, $PD_1 = PD_2 = 0$, $P_{IN} = -20dBm$, $f_{RF} = 350MHz$, and $T_C = +25^\circ C$, unless otherwise noted.)

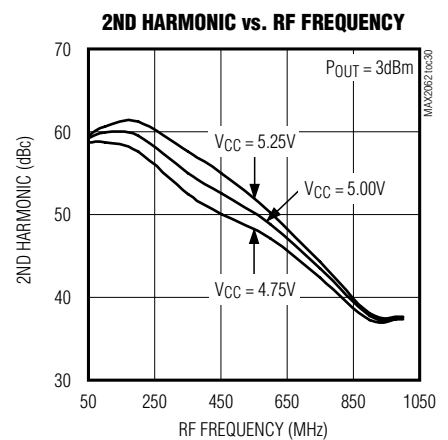
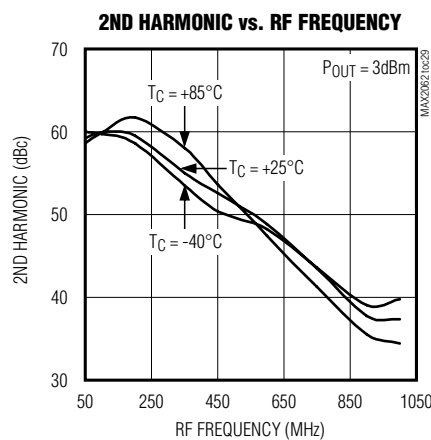
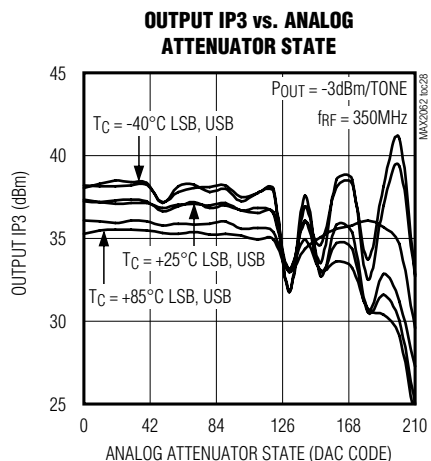
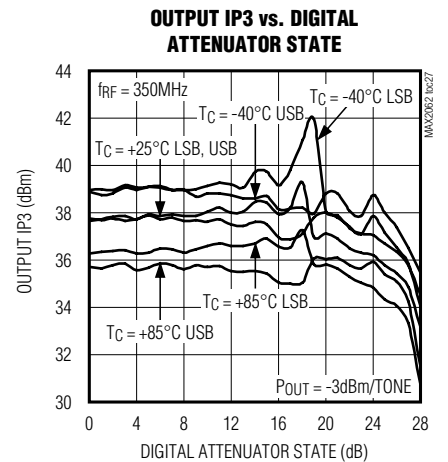
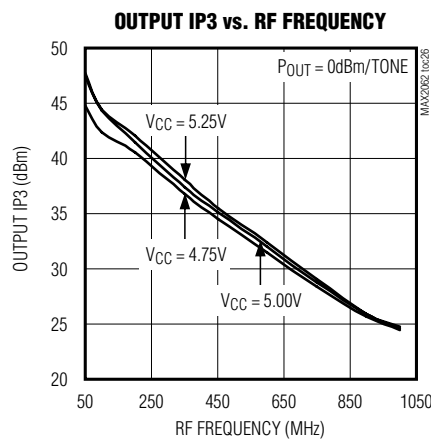
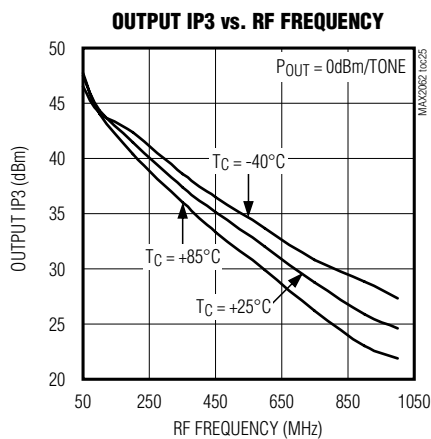
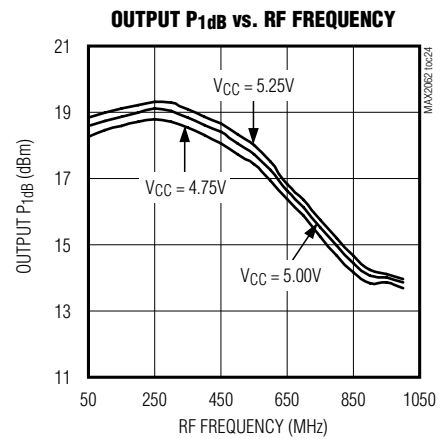
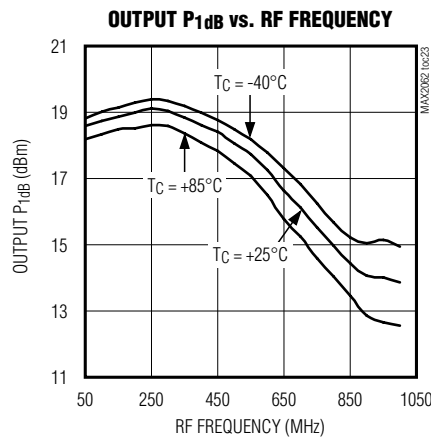
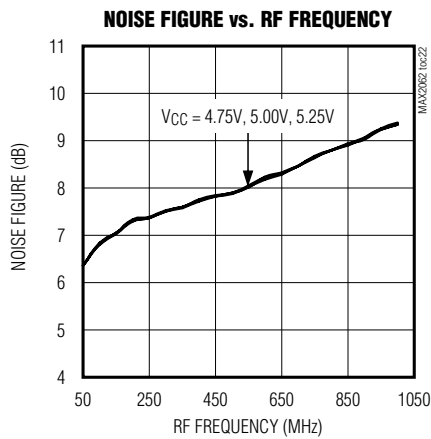

MAX2062

Dual 50MHz to 1000MHz High-Linearity, Serial/Parallel-Controlled Analog/Digital VGA

Typical Operating Characteristics (continued)

(Typical Application Circuit, $V_{CC} = V_{CC_AMP_1} = V_{CC_AMP_2} = V_{CC_RG} = 5.0V$, attenuators are set for maximum gain, RF ports are driven from 50Ω sources, $AMPSET = 0$, $PD_1 = PD_2 = 0$, $P_{IN} = -20dBm$, $f_{RF} = 350MHz$, and $T_C = +25^\circ C$, unless otherwise noted.)

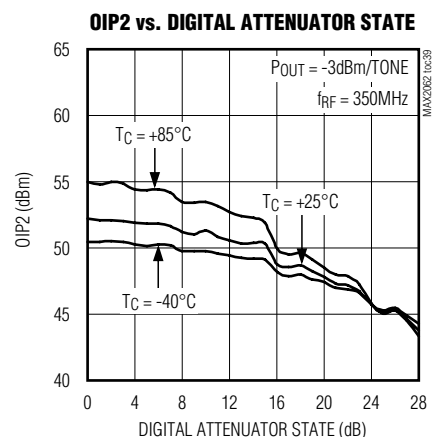
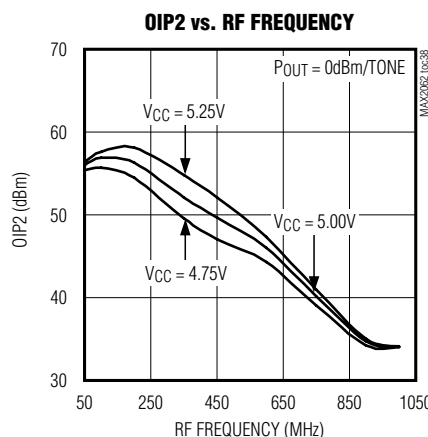
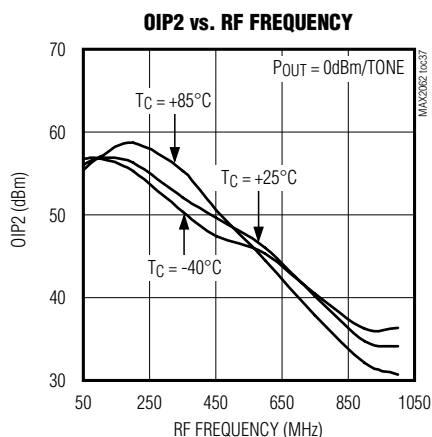
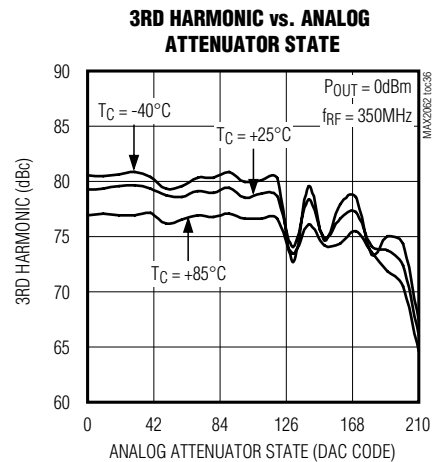
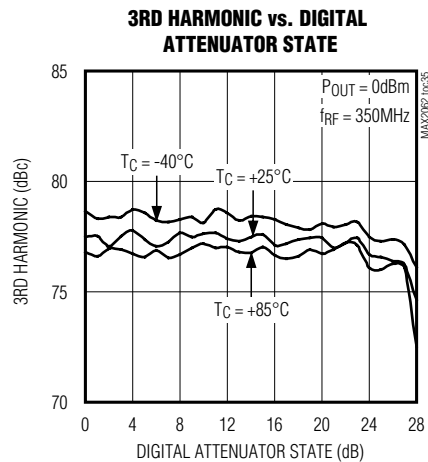
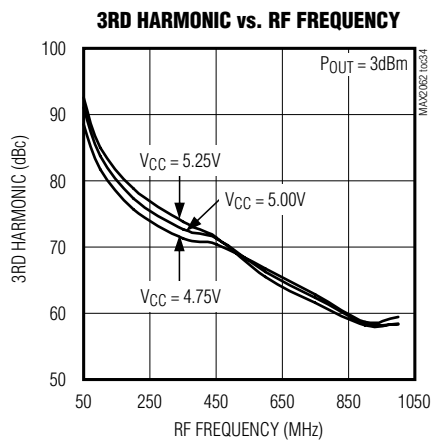
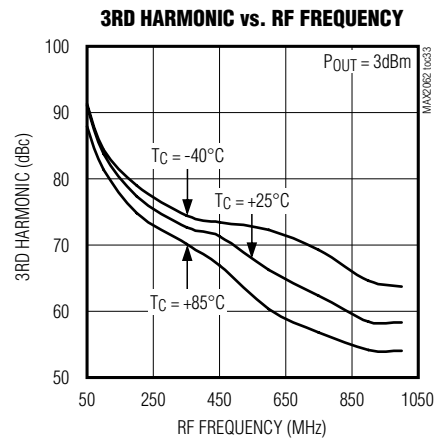
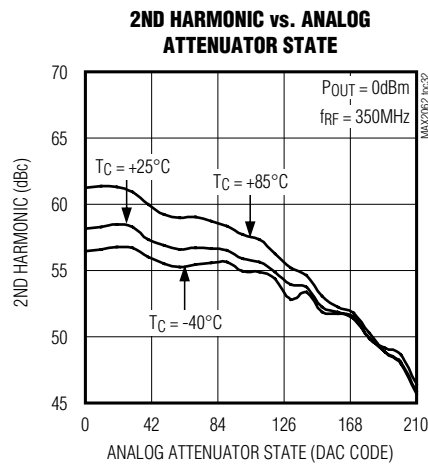
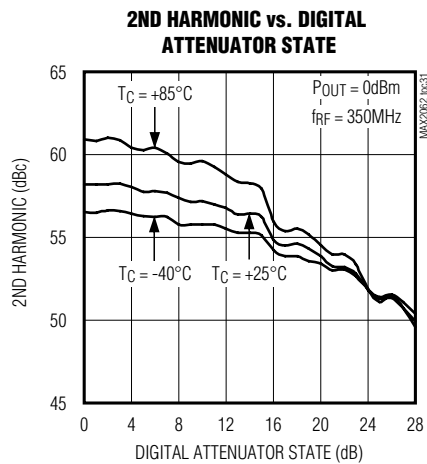

Dual 50MHz to 1000MHz High-Linearity, Serial/Parallel-Controlled Analog/Digital VGA

Typical Operating Characteristics (continued)

(Typical Application Circuit, $V_{CC} = V_{CC_AMP_1} = V_{CC_AMP_2} = V_{CC_RG} = 5.0V$, attenuators are set for maximum gain, RF ports are driven from 50Ω sources, $AMPSET = 0$, $PD_1 = PD_2 = 0$, $P_{IN} = -20dBm$, $f_{RF} = 350MHz$, and $T_C = +25^\circ C$, unless otherwise noted.)

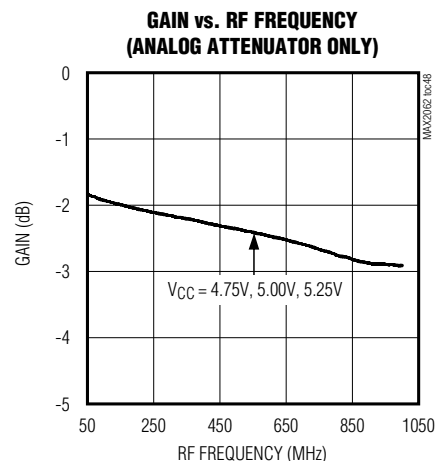
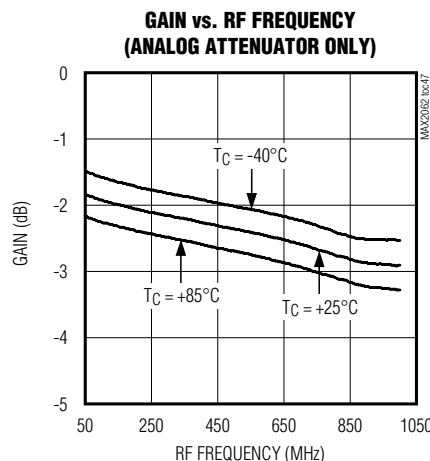
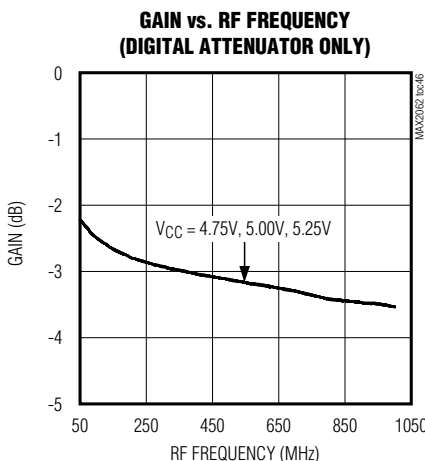
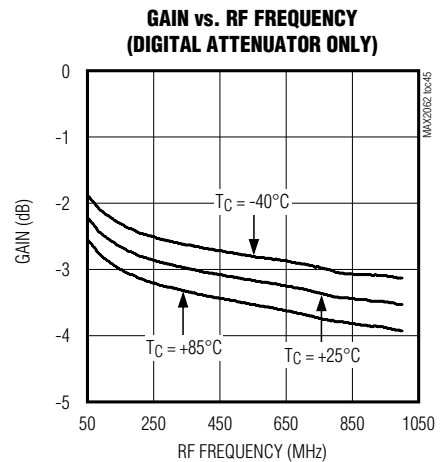
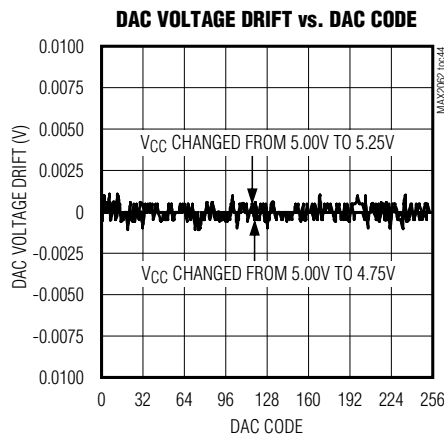
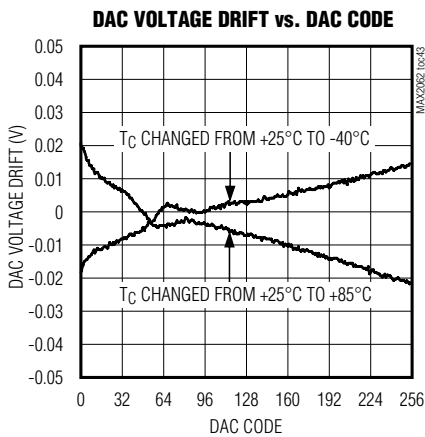
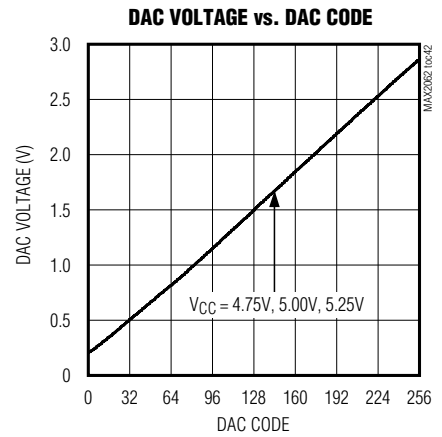
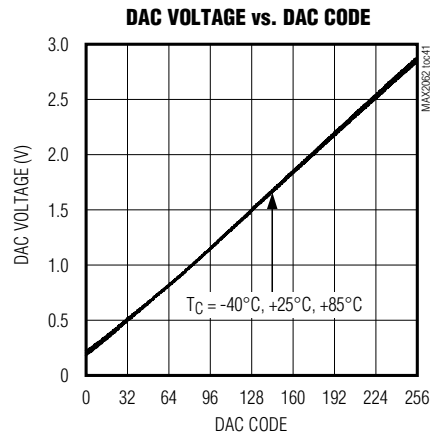
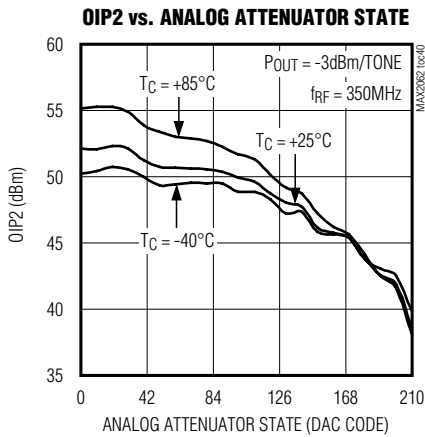

MAX2062

Dual 50MHz to 1000MHz High-Linearity, Serial/Parallel-Controlled Analog/Digital VGA

Typical Operating Characteristics (continued)

(Typical Application Circuit, $V_{CC} = V_{CC_AMP_1} = V_{CC_AMP_2} = V_{CC_RG} = 3.3V$, attenuators are set for maximum gain, RF ports are driven from 50Ω sources, $AMPSET = 1$, $PD_1 = PD_2 = 0$, $P_{IN} = -20dBm$, $f_{RF} = 350MHz$, and $T_C = +25^\circ C$, unless otherwise noted.)

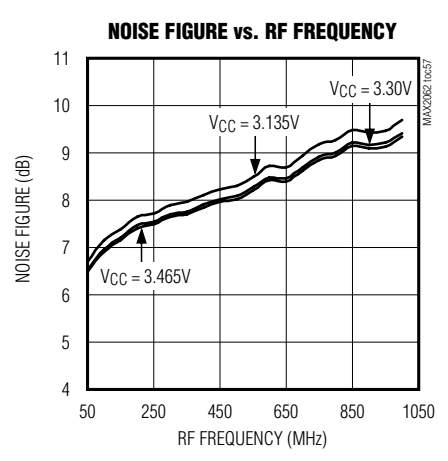
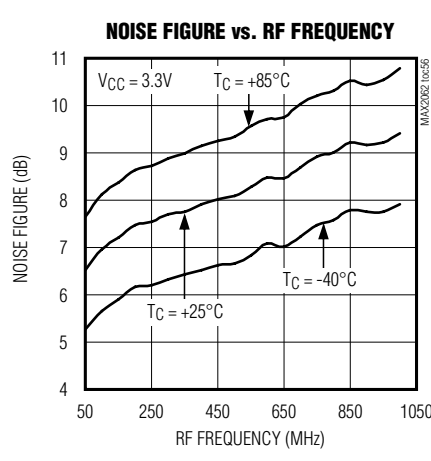
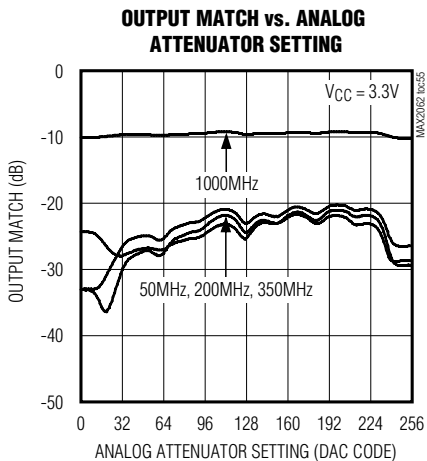
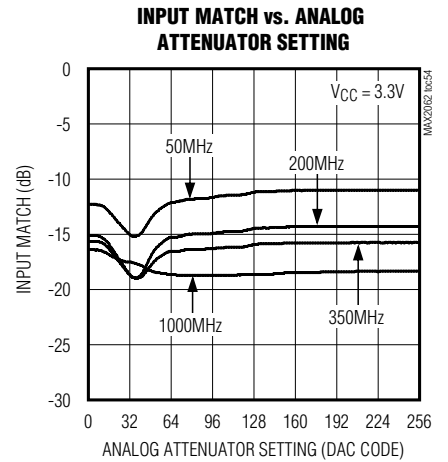
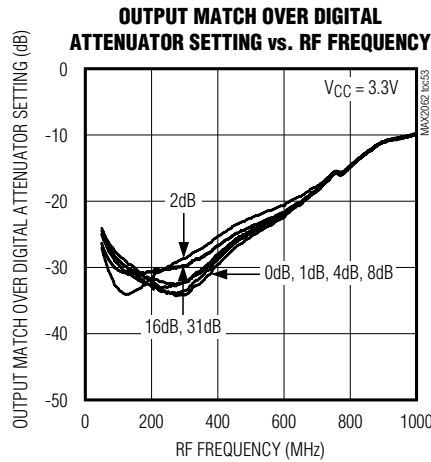
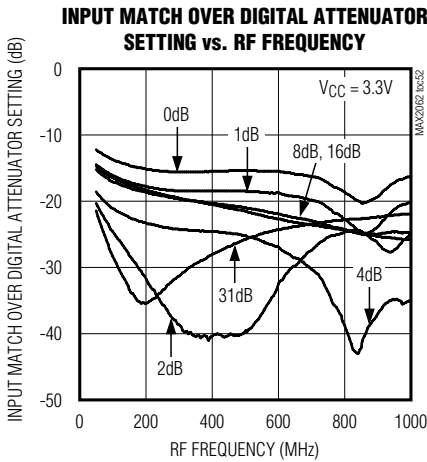
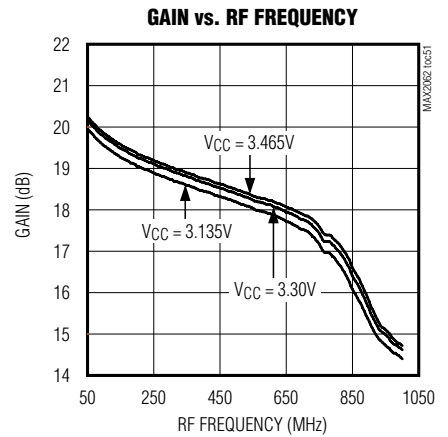
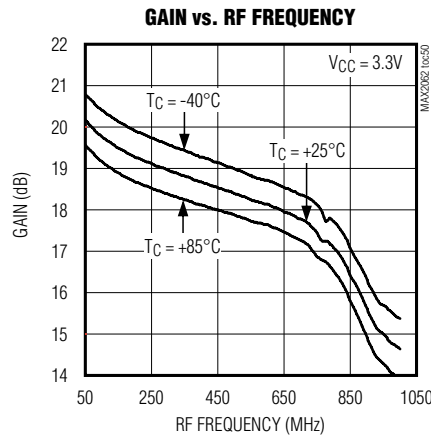
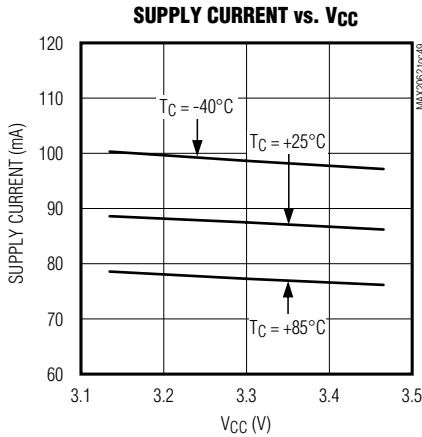

Dual 50MHz to 1000MHz High-Linearity, Serial/Parallel-Controlled Analog/Digital VGA

Typical Operating Characteristics (continued)

(Typical Application Circuit, $V_{CC} = V_{CC_AMP_1} = V_{CC_AMP_2} = V_{CC_RG} = 3.3V$, attenuators are set for maximum gain, RF ports are driven from 50Ω sources, $AMPSET = 1$, $PD_1 = PD_2 = 0$, $P_{IN} = -20dBm$, $f_{RF} = 350MHz$, and $T_C = +25^\circ C$, unless otherwise noted.)

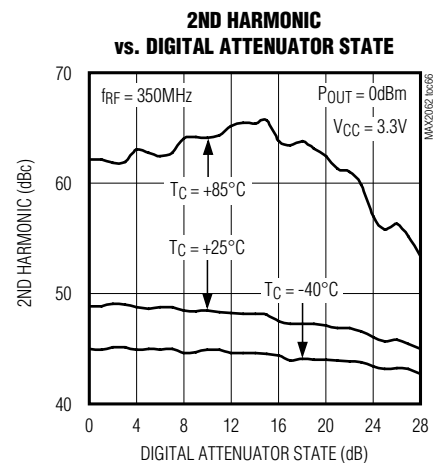
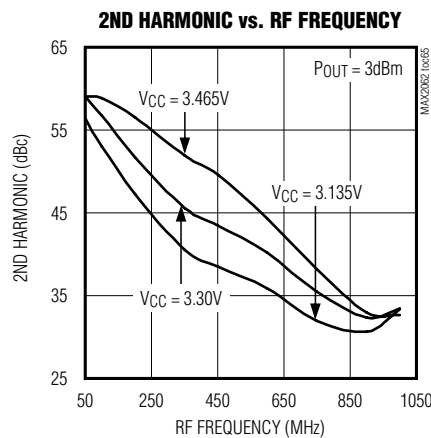
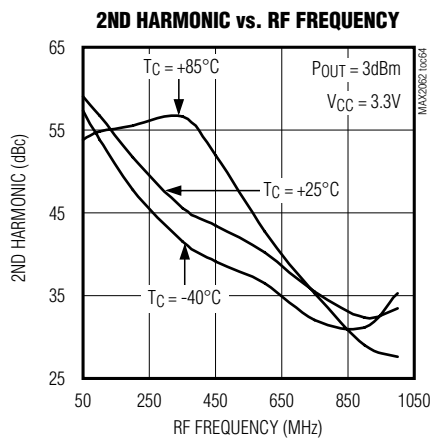
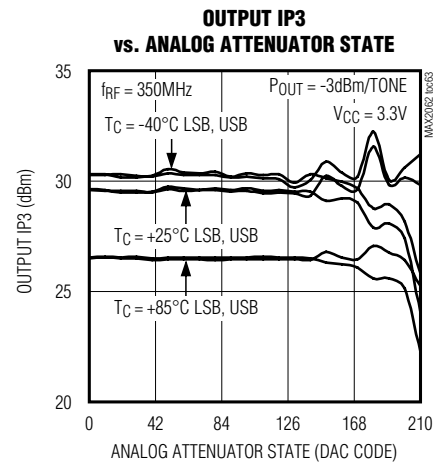
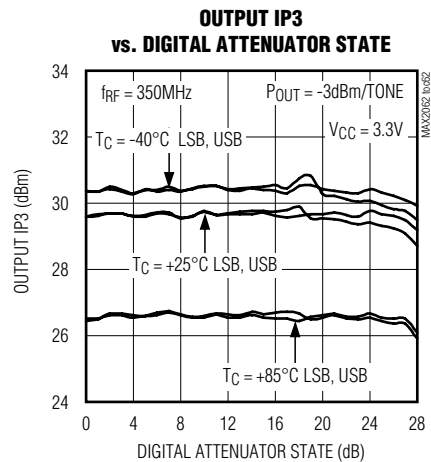
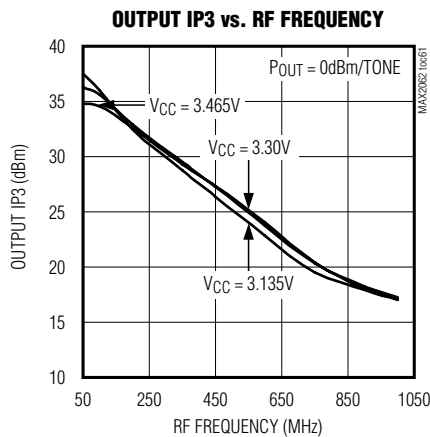
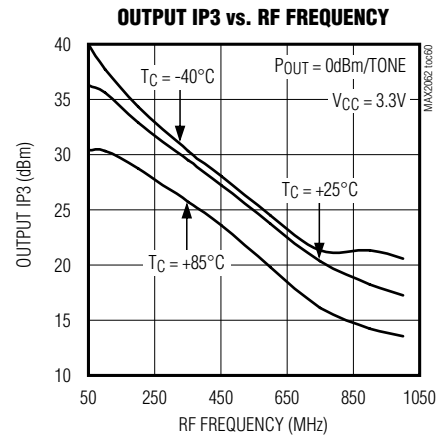
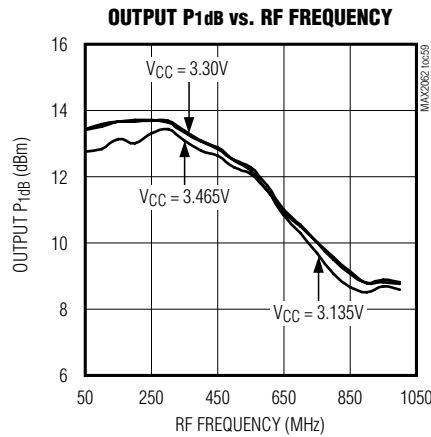
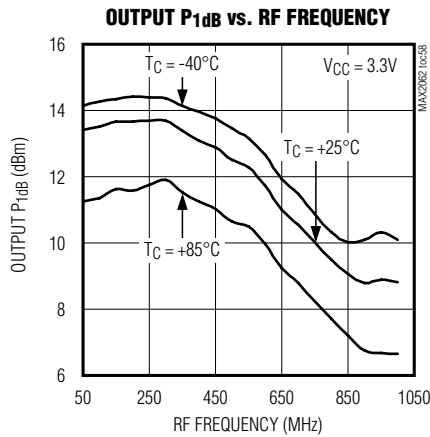

MAX2062

Dual 50MHz to 1000MHz High-Linearity, Serial/Parallel-Controlled Analog/Digital VGA

Typical Operating Characteristics (continued)

(Typical Application Circuit, $V_{CC} = V_{CC_AMP_1} = V_{CC_AMP_2} = V_{CC_RG} = 3.3V$, attenuators are set for maximum gain, RF ports are driven from 50Ω sources, $AMPSET = 1$, $PD_1 = PD_2 = 0$, $P_{IN} = -20dBm$, $f_{RF} = 350MHz$, and $T_C = +25^\circ C$, unless otherwise noted.)

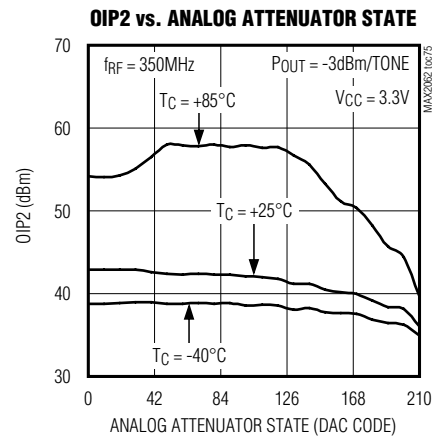
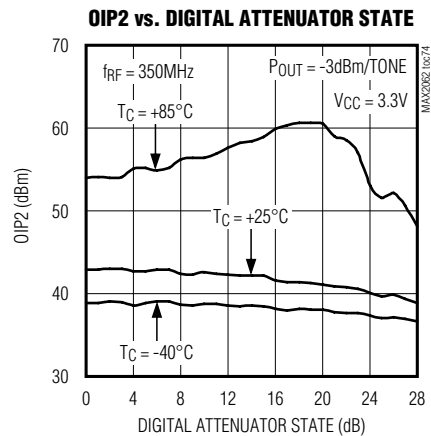
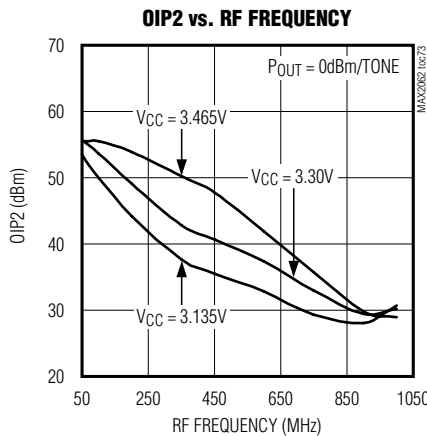
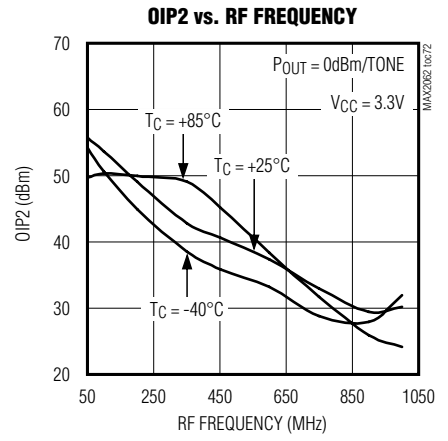
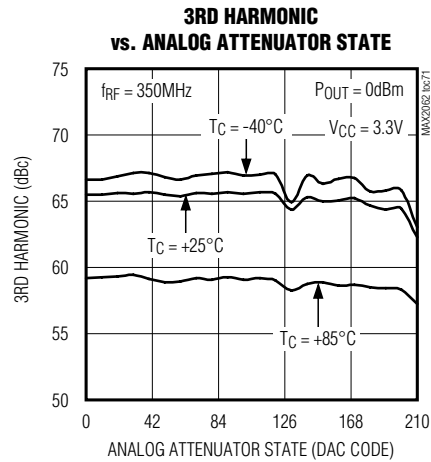
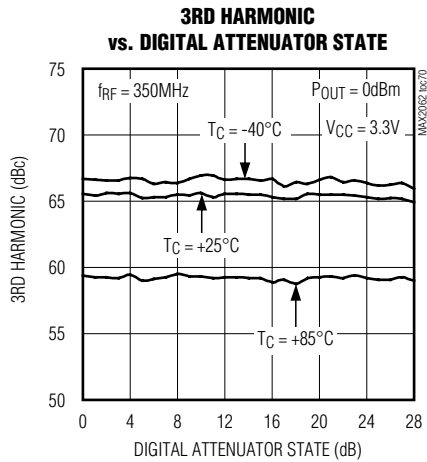
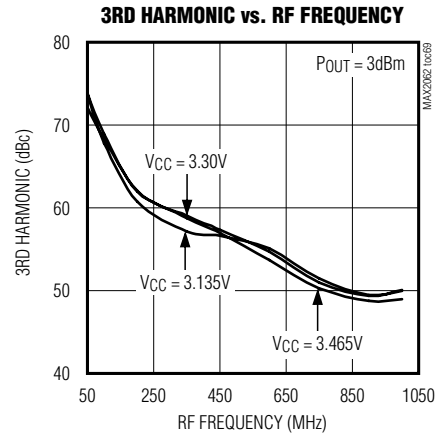
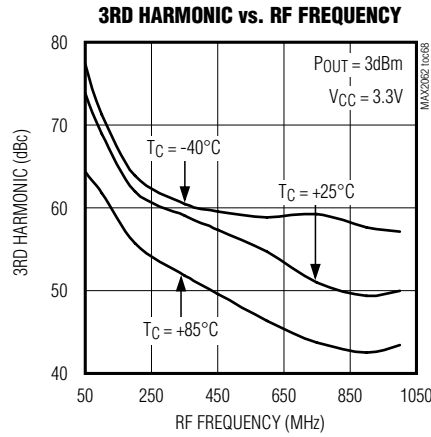
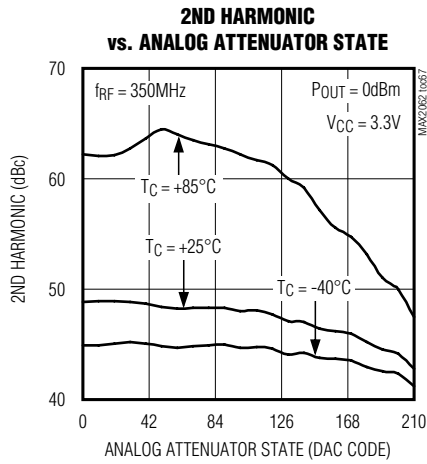

MAX2062

Dual 50MHz to 1000MHz High-Linearity, Serial/Parallel-Controlled Analog/Digital VGA

Pin Configuration

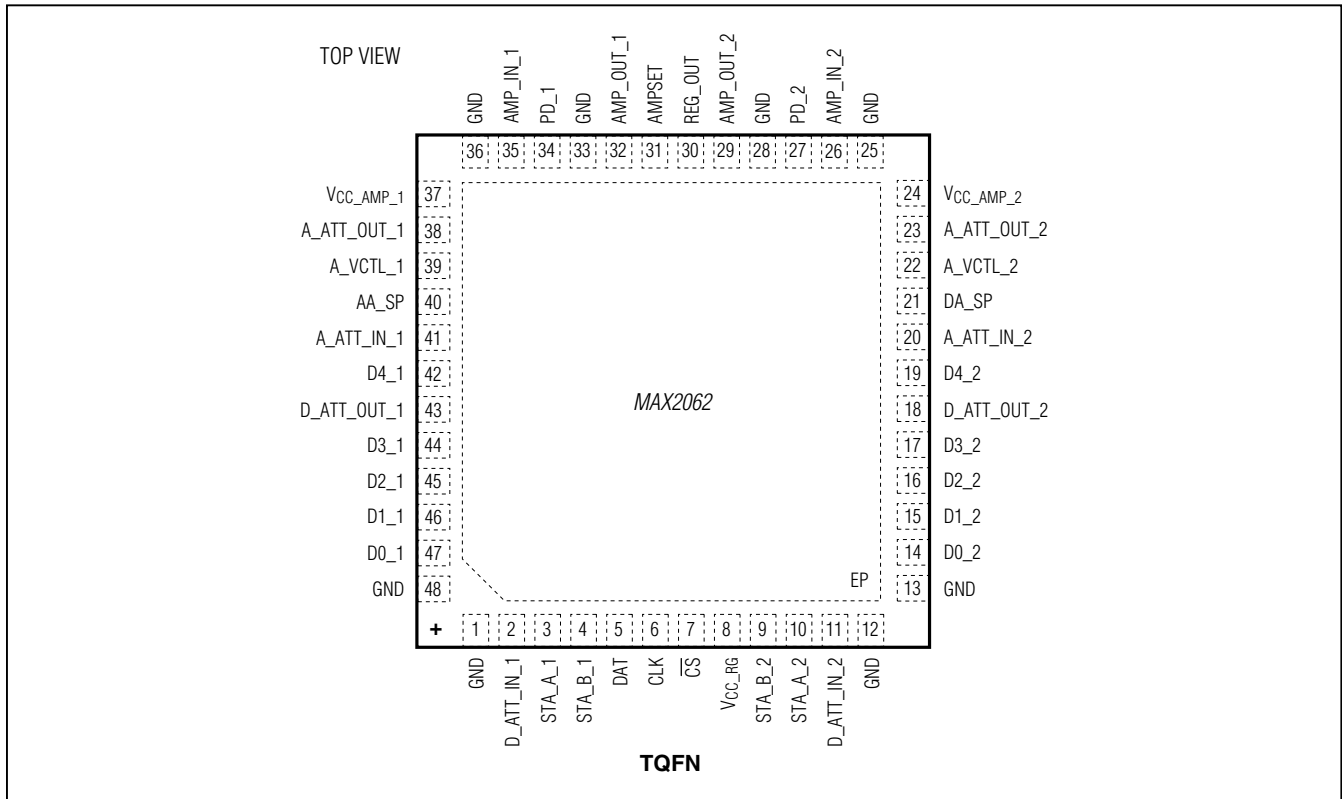

Pin Description

PIN	NAME	FUNCTION															
1, 12, 13, 25, 28, 33, 36, 48	GND	Ground															
2	D_ATT_IN_1	5-Bit Digital Attenuator Input (50Ω), Path 1. Requires a DC-blocking capacitor.															
3	STA_A_1	Digital Attenuator Preprogrammed Attenuation-State Logic Input, Path 1 <table border="1"> <thead> <tr> <th>State A</th> <th>State B</th> <th>Digital Attenuator</th> </tr> </thead> <tbody> <tr> <td>Logic = 0</td> <td>Logic = 0</td> <td>Preprogrammed State 1</td> </tr> <tr> <td>Logic = 1</td> <td>Logic = 0</td> <td>Preprogrammed State 2</td> </tr> <tr> <td>Logic = 0</td> <td>Logic = 1</td> <td>Preprogrammed State 3</td> </tr> <tr> <td>Logic = 1</td> <td>Logic = 1</td> <td>Preprogrammed State 4</td> </tr> </tbody> </table>	State A	State B	Digital Attenuator	Logic = 0	Logic = 0	Preprogrammed State 1	Logic = 1	Logic = 0	Preprogrammed State 2	Logic = 0	Logic = 1	Preprogrammed State 3	Logic = 1	Logic = 1	Preprogrammed State 4
State A	State B		Digital Attenuator														
Logic = 0	Logic = 0		Preprogrammed State 1														
Logic = 1	Logic = 0		Preprogrammed State 2														
Logic = 0	Logic = 1	Preprogrammed State 3															
Logic = 1	Logic = 1	Preprogrammed State 4															
4	STA_B_1																
5	DAT	SPI Data Digital Input															
6	CLK	SPI Clock Digital Input															
7	$\overline{\text{CS}}$	SPI Chip-Select Digital Input															
8	VCC_RG	Regulator Supply Input. Connect to a 3.3V or 5V external power supply. VCC_RG powers all circuits except for the driver amplifiers. Bypass with a 10nF capacitor as close as possible to the pin.															

MAX2062

Dual 50MHz to 1000MHz High-Linearity, Serial/Parallel-Controlled Analog/Digital VGA

Pin Description (continued)

PIN	NAME	FUNCTION															
9	STA_B_2	Digital Attenuator Preprogrammed Attenuation-State Logic Input, Path 2 <table border="0"> <tr> <td>State A</td> <td>State B</td> <td>Digital Attenuator</td> </tr> <tr> <td>Logic = 0</td> <td>Logic = 0</td> <td>Preprogrammed State 1</td> </tr> <tr> <td>Logic = 1</td> <td>Logic = 0</td> <td>Preprogrammed State 2</td> </tr> <tr> <td>Logic = 0</td> <td>Logic = 1</td> <td>Preprogrammed State 3</td> </tr> <tr> <td>Logic = 1</td> <td>Logic = 1</td> <td>Preprogrammed State 4</td> </tr> </table>	State A	State B	Digital Attenuator	Logic = 0	Logic = 0	Preprogrammed State 1	Logic = 1	Logic = 0	Preprogrammed State 2	Logic = 0	Logic = 1	Preprogrammed State 3	Logic = 1	Logic = 1	Preprogrammed State 4
State A	State B		Digital Attenuator														
Logic = 0	Logic = 0		Preprogrammed State 1														
Logic = 1	Logic = 0		Preprogrammed State 2														
Logic = 0	Logic = 1	Preprogrammed State 3															
Logic = 1	Logic = 1	Preprogrammed State 4															
10	STA_A_2																
11	D_ATT_IN_2	5-Bit Digital Attenuator Input (50Ω), Path 2. Requires a DC-blocking capacitor.															
14	D0_2	1dB Attenuator Logic Input, Path 2. Logic 0 = disable, logic 1 = enable.															
15	D1_2	2dB Attenuator Logic Input, Path 2. Logic 0 = disable, logic 1 = enable.															
16	D2_2	4dB Attenuator Logic Input, Path 2. Logic 0 = disable, logic 1 = enable.															
17	D3_2	8dB Attenuator Logic Input, Path 2. Logic 0 = disable, logic 1 = enable.															
18	D_ATT_OUT_2	5-Bit Digital Attenuator Output (50Ω), Path 2. Requires a DC-blocking capacitor. Connect to A_ATT_IN_2 through a 1000pF capacitor.															
19	D4_2	16dB Attenuator Logic Input, Path 2. Logic 0 = disable, logic 1 = enable.															
20	A_ATT_IN_2	Analog Attenuator Input (50Ω), Path 2. Requires a DC-blocking capacitor. Connect to D_ATT_OUT_2 through a 1000pF capacitor.															
21	DA_SP	Digital Attenuator Serial/Parallel Control Select. Set DA_SP to logic 1 to select serial control. Set DA_SP to logic 0 to select parallel control.															
22	A_VCTL_2	Analog Attenuator Voltage Control Input, Path 2. Bypass to ground with a 150pF capacitor if on-chip DAC is used (AA_SP = 1).															
23	A_ATT_OUT_2	Analog Attenuator Output (50Ω), Path 2. Requires a DC-blocking capacitor. Connect to AMP_IN_2 through a 1000pF capacitor.															
24	VCC_AMP_2	Driver Amplifier Supply Voltage Input, Path 2. Bypass with a 10nF capacitor as close as possible to the pin.															
26	AMP_IN_2	Driver Amplifier Input (50Ω), Path 2. Requires a DC-blocking capacitor. Connect to A_ATT_OUT_2 through a 1000pF capacitor.															
27	PD_2	Power-Down, Path 2. See Table 2 for operation details.															
29	AMP_OUT_2	Driver Amplifier Output (50Ω), Path 2. Connect a pullup inductor from AMP_OUT_2 to VCC_.															
30	REG_OUT	Regulator Output. Bypass with 1μF capacitor.															
31	AMPSET	Driver Amplifier Bias Setting for 3.3V Operation. Set to logic 1 for 3.3V operation on pins VCC_AMP_1 and VCC_AMP_2. Set to logic 0 for 5V operation.															
32	AMP_OUT_1	Driver Amplifier Output (50Ω), Path 1. Connect a pullup inductor from AMP_OUT_1 to VCC_.															
34	PD_1	Power-Down, Path 1. See Table 2 for operation details.															
35	AMP_IN_1	Driver Amplifier Input (50Ω), Path 1. Requires a DC-blocking capacitor. Connect to A_ATT_OUT_1 through a 1000pF capacitor.															
37	VCC_AMP_1	Driver Amplifier Supply Voltage Input, Path 1. Bypass with a 10nF capacitor as close as possible to the pin.															
38	A_ATT_OUT_1	Analog Attenuator Output (50Ω), Path 1. Requires a DC-blocking capacitor. Connect to AMP_IN_1 through a 1000pF capacitor.															
39	A_VCTL_1	Analog Attenuator Voltage Control Input, Path 1. Bypass to ground with a 150pF capacitor if on-chip DAC is used (AA_SP = 1).															

Dual 50MHz to 1000MHz High-Linearity, Serial/Parallel-Controlled Analog/Digital VGA

Pin Description (continued)

PIN	NAME	FUNCTION
40	AA_SP	DAC Enable/Disable Logic Input for Analog Attenuators. Set AA_SP to logic 1 to enable on-chip DAC circuit and digital SPI control. Set AA_SP to logic 0 to disable DAC circuit and digital SPI control. When AA_SP = 0, use analog control lines (A_VCTL_1 and A_VCTL_2).
41	A_ATT_IN_1	Analog Attenuator Input (50Ω), Path 1. Requires a DC-blocking capacitor. Connect to D_ATT_OUT_1 through a 1000pF capacitor.
42	D4_1	16dB Attenuator Logic Input, Path 1. Logic 0 = disable, logic 1 = enable.
43	D_ATT_OUT_1	5-Bit Digital Attenuator Output (50Ω), Path 1. Requires a DC-blocking capacitor. Connect to A_ATT_IN_1 through a 1000pF capacitor.
44	D3_1	8dB Attenuator Logic Input, Path 1. Logic 0 = disable, logic 1 = enable.
45	D2_1	4dB Attenuator Logic Input, Path 1. Logic 0 = disable, logic 1 = enable.
46	D1_1	2dB Attenuator Logic Input, Path 1. Logic 0 = disable, logic 1 = enable.
47	D0_1	1dB Attenuator Logic Input, Path 1. Logic 0 = disable, logic 1 = enable.
—	EP	Exposed Pad. Internally connected to GND. Connect to GND for proper RF performance and enhanced thermal dissipation.

Detailed Description

The MAX2062 high-linearity analog/digital VGA is a general-purpose, high-performance amplifier designed to interface with 50Ω systems operating in the 50MHz to 1000MHz frequency range.

Each channel of the device integrates one digital attenuator and one analog attenuator to provide 64dB of total gain control, as well as a driver amplifier optimized to provide high gain, high IP3, low NF, and low power consumption.

Each digital attenuator is controlled as a slave peripheral using either the SPI-compatible interface, or a 5-bit parallel bus with 31dB total adjustment range in 1dB steps. An added feature allows rapid-fire gain selection among each of the four steps, preprogrammed by the user through the SPI-compatible interface. A separate 2-pin control lets the user quickly access any one of four customized attenuation states without reprogramming the SPI bus. Each analog attenuator is controlled using an external voltage or through the SPI-compatible interface using an on-chip 8-bit DAC. See the *Applications Information* section for attenuator programming details.

Because each of the three stages in the separate signal paths has its own RF input and RF output, this component can be configured to either optimize NF (amplifier configured first), OIP3 (amplifier last), or a compromise of NF and OIP3. The device's performance features include 24dB amplifier gain (amplifier only), 7.3dB NF at maximum gain (includes attenuator insertion losses),

and a high OIP3 level of +41dBm. Each of these features makes the device an ideal VGA for multipath receiver and transmitter applications.

In addition, the device operates from a single +5V supply with full performance, or a +3.3V supply for an enhanced power-savings mode with lower performance. The device is available in a compact 48-pin TQFN package (7mm x 7mm) with an exposed pad. Electrical performance is guaranteed over the extended temperature range (T_C = -40°C to +85°C).

Analog and 5-Bit Digital Attenuator Control

The device integrates two analog attenuators and two 5-bit digital attenuators to achieve a high level of dynamic range. Each analog attenuator has a 33dB range and is controlled using an external voltage or through the 3-wire SPI interface using an on-chip 8-bit DAC. Each digital attenuator has a 31dB control range, a 1dB step size, and is programmed either through the 3-wire SPI or through a separate 5-bit parallel bus. See the *Applications Information* section and Table 1 for attenuator programming details. The attenuators can be used for both static and dynamic power control.

Note that when the analog attenuators are controlled by the DACs through the SPI bus, the DAC output voltage shows on pins A_VCTL_1 and A_VCTL_2 (pins 39 and 22, respectively). Therefore, in SPI mode, the A_VCTL_1 and A_VCTL_2 pins must only connect to the resistor and capacitor to ground, as shown in the *Typical Application Circuit*.

MAX2062

Dual 50MHz to 1000MHz High-Linearity, Serial/Parallel-Controlled Analog/Digital VGA

Table 1. Control Logic

AA_SP	ANALOG ATTENUATOR	D/A CONVERTER
0	Controlled by external control voltage	Disabled
1	Controlled by on-chip DAC	Enabled (DAC output voltage shows on A_VCTL__ pins); DAC uses on-chip voltage reference
DA_SP	DIGITAL ATTENUATOR	
0	Parallel controlled	
1	SPI controlled (control voltages show up on the parallel control pins)	

Driver Amplifier

Each path of the device includes a high-performance driver with a fixed gain of 24dB. The driver amplifier circuits are optimized for high linearity for the 50MHz to 1000MHz frequency range.

Applications Information

Operating Modes

The device features an optional +3.3V supply voltage operation with reduced linearity performance. The AMPSET pin needs to be biased accordingly in each mode, as listed in Table 2. In addition, the driver amplifiers can be shut down independently to conserve DC power. See the biasing scheme outlined in Table 2 for details.

SPI Interface and Attenuator Settings

The digital attenuators can be programmed through the 3-wire SPI/MICROWIRE®-compatible serial interface using 5-bit words. Fifty-six bits of data are shifted in MSB first and are framed by \overline{CS} . The first 28 bits set the first attenuator and the following 28 bits set the second attenuator. When \overline{CS} is low, the clock is active and data is shifted on the rising edge of the clock. When \overline{CS} transitions high, the data is latched and the attenuator setting changes (Figure 1). See Table 3 for details on the SPI data format.

Table 2. Operating Modes

RESULT	V _{CC} (V)	AMPSET	PD_1	PD_2
All on	5	0	0	0
	3.3	1	0	0
AMP1 off AMP2 on	5	0	1	0
	3.3	1	1	0
AMP1 on AMP2 off	5	0	0	1
	3.3	1	0	1
All off	5	0	1	1
	3.3	1	1	1

Path 1 DAC and Digital Attenuator Programming

D0:D7	Sent to DAC register D0 = LSB, D7 = MSB
D8:D12	Preprogrammed Attenuation State 1 D8 = 1dB bit, D9 = 2dB Bit, D10 = 4dB bit, D11 = 8dB bit, D12 = 16dB bit
D13:D17	Preprogrammed Attenuation State 2 D13 = 1dB bit, D14 = 2dB bit, D15 = 4dB bit, D16 = 8dB bit, D17 = 16dB bit
D18:D22	Preprogrammed Attenuation State 3 D18 = 1dB bit, D19 = 2dB bit, D20 = 4dB bit, D21 = 8dB bit, D22 = 16dB bit
D23:D27	Preprogrammed Attenuation State 4 D23 = 1dB bit, D24 = 2dB bit, D25 = 4dB bit, D26 = 8dB bit, D27 = 16dB bit

Path 2 DAC and Digital Attenuator Programming

D28:D35	Sent to DAC register D28 = LSB, D35 = MSB
D36:D40	Preprogrammed Attenuation State 1 D36 = 1dB bit, D37 = 2dB bit, D38 = 4dB bit, D39 = 8dB bit, D40 = 16dB bit
D41:D45	Preprogrammed Attenuation State 2 D41 = 1dB bit, D42 = 2dB bit, D43 = 4dB bit, D44 = 8dB bit, D45 = 16dB bit
D46:D50	Preprogrammed Attenuation State 3 D46 = 1dB bit, D47 = 2dB bit, D48 = 4dB bit, D49 = 8dB bit, D50 = 16dB bit
D51:D55	Preprogrammed Attenuation State 4 D51 = 1dB bit, D52 = 2dB bit, D53 = 4dB bit, D54 = 8dB bit, D55 = 16dB bit

MICROWIRE is a registered trademark of National Semiconductor Corp.

Dual 50MHz to 1000MHz High-Linearity, Serial/Parallel-Controlled Analog/Digital VGA

Table 3. SPI Data Format

FUNCTION	BIT	DESCRIPTION
Digital Attenuator State 4 (Path 2)	D55 (MSB)	16dB step (MSB of the 5-bit word used to program the Path 2 digital attenuator state 4)
	D54	8dB step
	D53	4dB step
	D52	2dB step
	D51	1dB step
Digital Attenuator State 3 (Path 2)	D50	16dB step (MSB of the 5-bit word used to program the Path 2 digital attenuator state 3)
	D49	8dB step
	D48	4dB step
	D47	2dB step
	D46	1dB step
Digital Attenuator State 2 (Path 2)	D45	16dB step (MSB of the 5-bit word used to program the Path 2 digital attenuator state 2)
	D44	8dB step
	D43	4dB step
	D42	2dB step
	D41	1dB step
Digital Attenuator State 1 (Path 2)	D40	16dB step (MSB of the 5-bit word used to program the Path 2 digital attenuator state 1)
	D39	8dB step
	D38	4dB step
	D37	2dB step
	D36	1dB step
On-Chip DAC (Path 2)	D35	Bit 7 (MSB) of on-chip DAC used to program the Path 2 analog attenuator
	D34	Bit 6 of DAC
	D33	Bit 5 of DAC
	D32	Bit 4 of DAC
	D31	Bit 3 of DAC
	D30	Bit 2 of DAC
	D29	Bit 1 of DAC
	D28	Bit 0 (LSB) of DAC
Digital Attenuator State 4 (Path 1)	D27	16dB step (MSB of the 5-bit word used to program the Path 1 digital attenuator state 4)
	D26	8dB step
	D25	4dB step
	D24	2dB step
	D23	1dB step
Digital Attenuator State 3 (Path 1)	D22	16dB step (MSB of the 5-bit word used to program the Path 1 digital attenuator state 3)
	D21	8dB step
	D20	4dB step
	D19	2dB step
	D18	1dB step

MAX2062

Dual 50MHz to 1000MHz High-Linearity, Serial/Parallel-Controlled Analog/Digital VGA

Table 3. SPI Data Format (continued)

FUNCTION	BIT	DESCRIPTION
Digital Attenuator State 2 (Path 1)	D17	16dB step (MSB of the 5-bit word used to program the Path 1 digital attenuator state 2)
	D16	8dB step
	D15	4dB step
	D14	2dB step
	D13	1dB step
Digital Attenuator State 1 (Path 1)	D12	16dB step (MSB of the 5-bit word used to program the Path 1 digital attenuator state 1)
	D11	8dB step
	D10	4dB step
	D9	2dB step
	D8	1dB step
On-Chip DAC (Path 1)	D7	Bit 7 (MSB) of on-chip DAC used to program the Path 1 analog attenuator
	D6	Bit 6 of DAC
	D5	Bit 5 of DAC
	D4	Bit 4 of DAC
	D3	Bit 3 of DAC
	D2	Bit 2 of DAC
	D1	Bit 1 of DAC
	D0 (LSB)	Bit 0 (LSB) of DAC

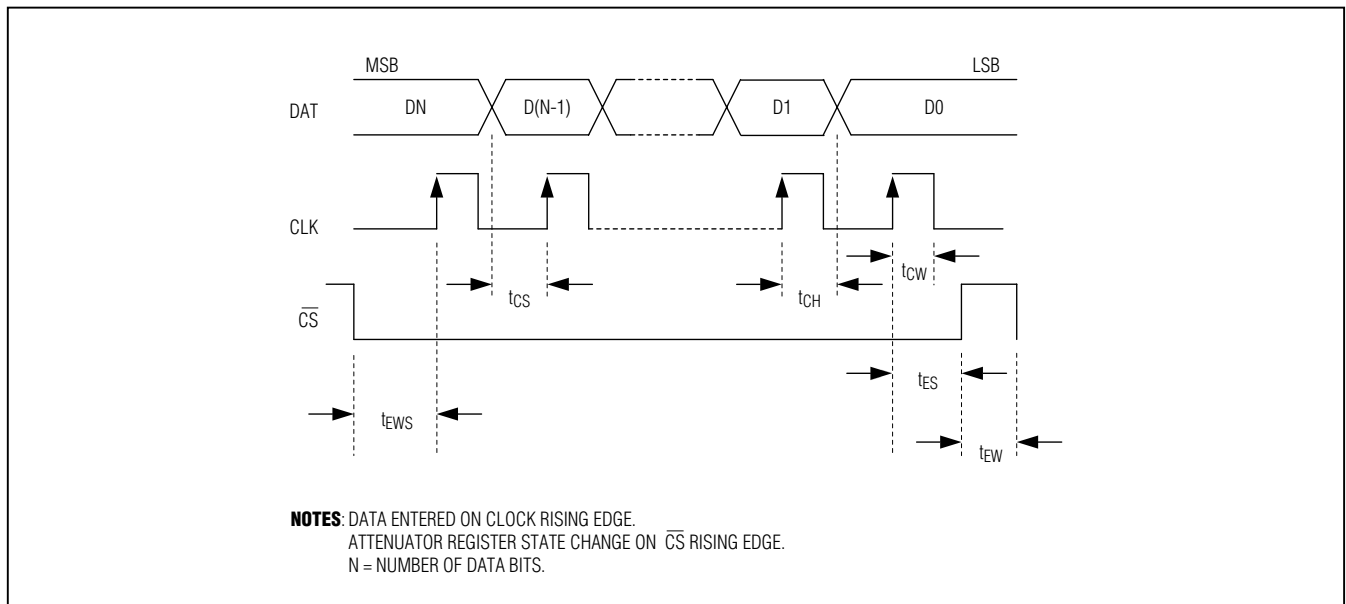

Figure 1. SPI Timing Diagram

Dual 50MHz to 1000MHz High-Linearity, Serial/Parallel-Controlled Analog/Digital VGA

Attenuator and DAC Operation

The two analog attenuators are controlled by an external control voltage applied at A_VCTL_1 and A_VCTL_2 (pins 39 and 22) or by the on-chip 8-bit DACs, while the digital attenuators are controlled through the SPI-compatible interface or through two independent, parallel 5-bit buses. The DAC enable/disable logic-input pin (AA_SP) and digital attenuator SPI/parallel control selection logic-input pin (DA_SP) determine how the attenuators are controlled.

Digital Attenuator Settings Using the Parallel Control Bus

To capitalize on its fast 25ns switching capability, the device offers a supplemental 5-bit parallel control interface. The digital logic attenuator control pins (D0–D4_) enable the attenuator stages (see Tables 3 and 4).

Direct access to these 5-bit buses enables the user to avoid any programming delays associated with the SPI interface. One of the limitations of any SPI bus is the speed at which commands can be clocked into each peripheral device. By offering direct access to the 5-bit parallel interface, the user can quickly shift between digital attenuator states needed for critical fast-attack automatic gain control (AGC) applications.

Note that when the digital attenuators are controlled by the SPI bus, the control voltages of each digital attenuator appears on the five parallel control pins (pins 14–17

and 19 for digital attenuator 2, pins 42 and 44–47 for digital attenuator 1). **When the digital attenuators are in SPI mode, the parallel control pins must be left unconnected.**

Rapid-Fire Preprogrammed Attenuation States

The device has an added feature that provides rapid-fire gain selection among four preprogrammed attenuation steps. As with the supplemental 5-bit buses previously mentioned, this rapid-fire gain selection allows the user to quickly access any one of four customized digital attenuation states without incurring the delays associated with reprogramming the device through the SPI bus.

The switching speed is comparable to that achieved using the supplemental 5-bit parallel buses. However, by employing this specific feature, the digital attenuator I/O is further reduced by a factor of either 5 or 2.5 (5 control bits vs. 1 or 2, respectively), depending on the number of states desired.

The user can employ the STA_A_1 and STA_B_1 (STA_A_2 and STA_B_2 for digital attenuator 2) logic-input pins to apply each step as required (see Tables 5 and 6). Toggling just the STA_A_1 pin (1 control bit) yields two preprogrammed attenuation states; toggling both the STA_A_1 and STA_B_1 pins together (2 control bits) yields four preprogrammed attenuation states.

Table 4. Digital Attenuator Settings (Parallel Control, DA_SP = 0)

INPUT	LOGIC = 0 (OR GROUND)	LOGIC = 1
D0	Disable 1dB attenuator	Enable 1dB attenuator
D1	Disable 2dB attenuator	Enable 2dB attenuator
D2	Disable 4dB attenuator	Enable 4dB attenuator
D3	Disable 8dB attenuator	Enable 8dB attenuator
D4	Disable 16dB attenuator	Enable 16dB attenuator

Table 5. Programmed Attenuation State Settings for Attenuator 1 (DA_SP = 1)

STA_A_1	STA_B_1	SETTING FOR DIGITAL ATTENUATOR 1*
0	0	Preprogrammed attenuation state 1
1	0	Preprogrammed attenuation state 2
0	1	Preprogrammed attenuation state 3
1	1	Preprogrammed attenuation state 4

*Defined by SPI programming bits D8:D27 (see Table 3 for details).

Table 6. Programmed Attenuation State Settings for Attenuator 2 (DA_SP = 1)

STA_A_2	STA_B_2	SETTING FOR DIGITAL ATTENUATOR 2**
0	0	Preprogrammed attenuation state 1
1	0	Preprogrammed attenuation state 2
0	1	Preprogrammed attenuation state 3
1	1	Preprogrammed attenuation state 4

**Defined by SPI programming bits D36:D55 (see Table 3 for details).

MAX2062

Dual 50MHz to 1000MHz High-Linearity, Serial/Parallel-Controlled Analog/Digital VGA

As an example, assume that the AGC application requires a static attenuation adjustment to trim out gain inconsistencies within a receiver lineup. The same AGC circuit can also be called upon to dynamically attenuate an unwanted blocker signal that could desensitize the receiver and lead to an ADC overdrive condition. In this example, the device would be preprogrammed (through the SPI bus) with two customized attenuation states—one to address the static gain-trim adjustment, the second to counter the unwanted blocker condition.

Toggling just the STA_A_1 control bit enables the user to switch quickly between the static and dynamic attenuation settings with only one I/O pin.

If desired, the user can also program two additional attenuation states by using the STA_B_1 control bit as a second I/O pin. These two additional attenuation settings are useful for software-defined radio applications where multiple static gain settings are needed to account for different frequencies of operation, or where multiple dynamic attenuation settings are needed to account for different blocker levels (as defined by multiple wireless standards).

Power-Supply Sequencing

The sequence to be used is:

- 1) Power supply
- 2) Control lines

Layout Considerations

The pin configuration of the device is optimized to facilitate a very compact physical layout of the device and its associated discrete components. The exposed pad (EP) of the device's 48-pin TQFN-EP package provides a low thermal-resistance path to the die. It is important that the PCB on which the device is mounted be designed to conduct heat from the EP. In addition, provide the EP with a low inductance path to electrical ground. The EP **MUST** be soldered to a ground plane on the PCB, either directly or through an array of plated via holes. The layout of the PCB should include proper top-layer ground shielding to isolate the amplifier's inputs and outputs from each other. Shielding between the paths (inputs and outputs) is important for channel-to-channel isolation.

Table 7. Typical Application Circuit Component Values

DESIGNATION	QTY	DESCRIPTION	COMPONENT SUPPLIER
C1, C2, C5, C6, C8, C9, C12, C13	8	1000pF ceramic capacitors (0402) GRM1555C1H102J	Murata Electronics North America, Inc.
C3, C10	2	150pF ceramic capacitors (0402) GRM1555C1H151J	Murata Electronics North America, Inc.
C4, C7, C11, C14, C16	5	10nF ceramic capacitors (0402) GRM155R71E103K	Murata Electronics North America, Inc.
C15	1	1μF ceramic capacitor (0603) GRM188R71C105K	Murata Electronics North America, Inc.
L1, L2*	2	820nH inductors (1008) Coilcraft 1008CS-821XJLC	Coilcraft, Inc.
R1, R2	2	47.5kΩ resistors (0402)	—
U1	1	48 TQFN-EP (7mm x 7mm) Maxim MAX2062ETM	Maxim Integrated Products, Inc.

*Select the inductors to ensure that self-resonance of the inductors is outside the band of operation.

MAX2062

Dual 50MHz to 1000MHz High-Linearity, Serial/Parallel-Controlled Analog/Digital VGA

Typical Application Circuit

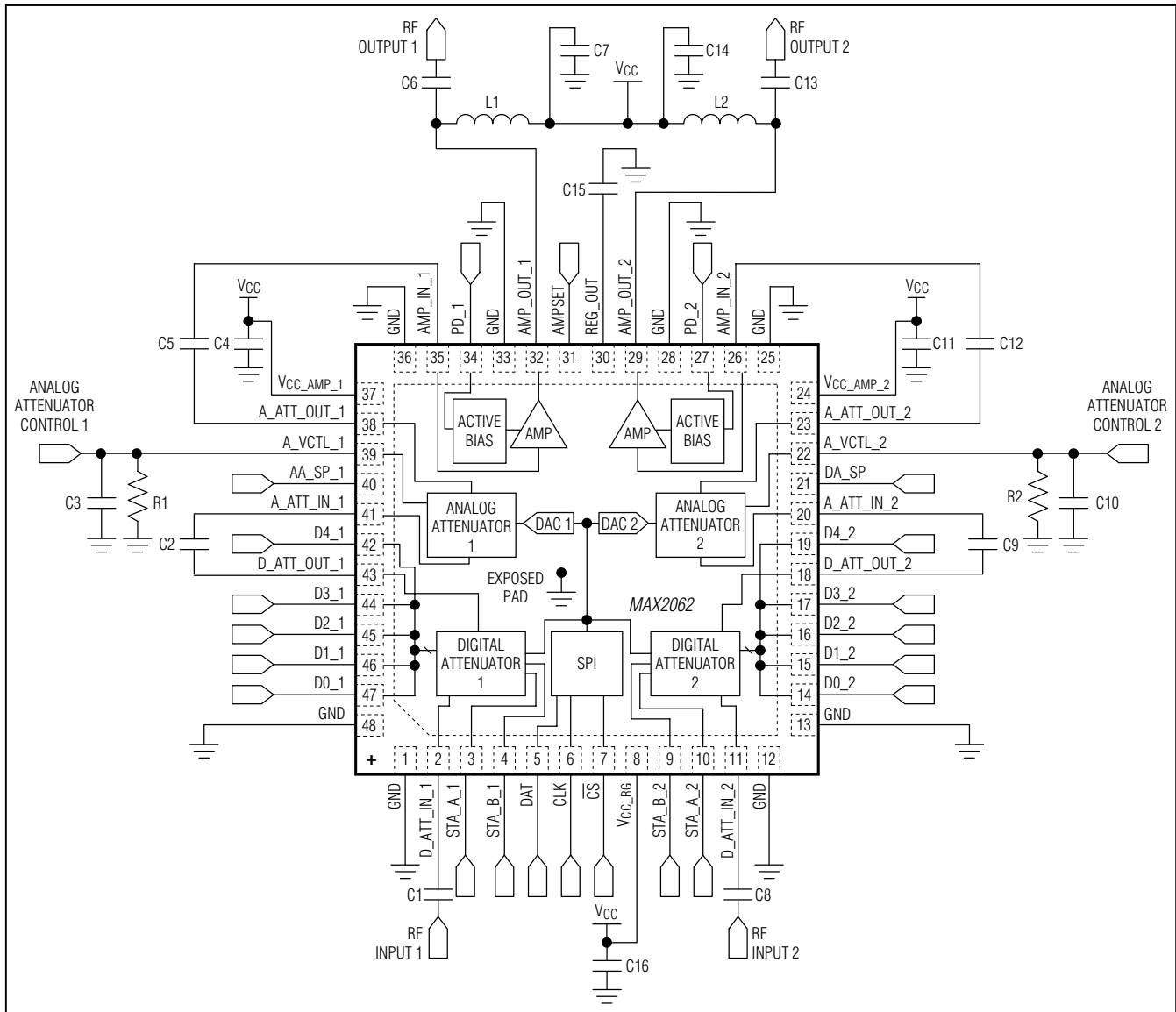

Chip Information

PROCESS: SiGe BiCMOS

Package Information

For the latest package outline information and land patterns, go to www.maximintegrated.com/packages. Note that a "+", "#", or "-" in the package code indicates RoHS status only. Package drawings may show a different suffix character, but the drawing pertains to the package regardless of RoHS status.

PACKAGE TYPE	PACKAGE CODE	OUTLINE NO.	LAND PATTERN NO.
48 TQFN-EP	T4877+7	21-0144	90-0133

MAX2062

Dual 50MHz to 1000MHz High-Linearity, Serial/Parallel-Controlled Analog/Digital VGA

Revision History

REVISION NUMBER	REVISION DATE	DESCRIPTION	PAGES CHANGED
0	9/10	Initial release	—
1	11/10	Updated <i>Output Voltage</i> specification	5
2	8/15	Removed military reference from <i>Applications</i>	1



Maxim Integrated cannot assume responsibility for use of any circuitry other than circuitry entirely embodied in a Maxim Integrated product. No circuit patent licenses are implied. Maxim Integrated reserves the right to change the circuitry and specifications without notice at any time. The parametric values (min and max limits) shown in the Electrical Characteristics table are guaranteed. Other parametric values quoted in this data sheet are provided for guidance.

Данный компонент на территории Российской Федерации

Вы можете приобрести в компании MosChip.

Для оперативного оформления запроса Вам необходимо перейти по данной ссылке:

<http://moschip.ru/get-element>

Вы можете разместить у нас заказ для любого Вашего проекта, будь то серийное производство или разработка единичного прибора.

В нашем ассортименте представлены ведущие мировые производители активных и пассивных электронных компонентов.

Нашей специализацией является поставка электронной компонентной базы двойного назначения, продукции таких производителей как XILINX, Intel (ex.ALTERA), Vicor, Microchip, Texas Instruments, Analog Devices, Mini-Circuits, Amphenol, Glenair.

Сотрудничество с глобальными дистрибьюторами электронных компонентов, предоставляет возможность заказывать и получать с международных складов практически любой перечень компонентов в оптимальные для Вас сроки.

На всех этапах разработки и производства наши партнеры могут получить квалифицированную поддержку опытных инженеров.

Система менеджмента качества компании отвечает требованиям в соответствии с ГОСТ Р ИСО 9001, ГОСТ РВ 0015-002 и ЭС РД 009

Офис по работе с юридическими лицами:

105318, г.Москва, ул.Щербаковская д.3, офис 1107, 1118, ДЦ «Щербаковский»

Телефон: +7 495 668-12-70 (многоканальный)

Факс: +7 495 668-12-70 (доб.304)

E-mail: info@moschip.ru

Skype отдела продаж:

moschip.ru

moschip.ru_4

moschip.ru_6

moschip.ru_9