

SLCD-3-KIT Serial LCD Driver

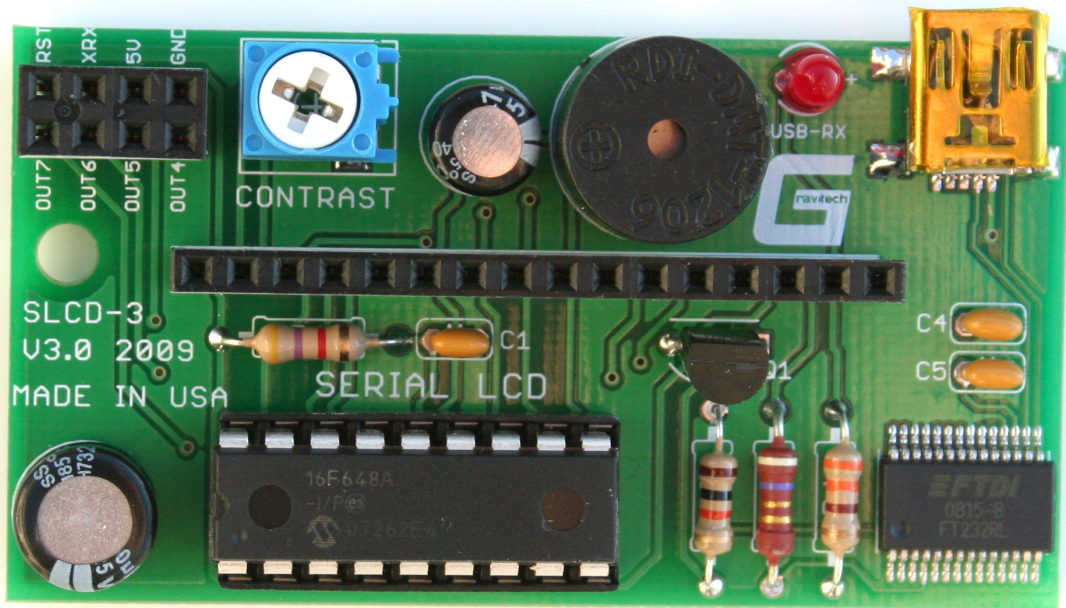

User Manual

Gravitech
2007 Copyright©
All Rights Reserved

Support: support@gravitech.us

V1.0
January 24, 2009



electronic experimental solutions

Table of Contents

	Copyrights and Disclaimer.....	3
1.	Introduction.....	4
2.	Connections.....	6
	Connector Pinout.....	6
	Power Connections.....	7
	Serial UART TTL Connections.....	8
	USB Communication.....	8
	General Purpose Outputs.....	9
	Beepers.....	9
	I/O LCD Connections.....	10
	Contrast Adjustment.....	10
	USB Communication Status LED.....	10
3.	Displaying Text.....	11
	General.....	11
	Built-In Character Font.....	11
	Writing Text to the Display.....	12
	Configure for LCD geometry	13
4.	Power up selftest and Special Characters.....	14
	Power Up Selftest.....	14
	Special Characters.....	14
5.	Big Number Mode.....	16
6.	Custom Text Screen.....	18
7.	Boot Screen Selection.....	18
8.	Miscellaneous Commands.....	19
9.	Appendix A: Command Summary.....	20
10.	Appendix B: Optional Parts.....	22

Copyrights

This documentation is copyright 2009 by Gravitech. By downloading or obtaining a printed copy of this documentation you agree that it is to be used exclusively with Gravitech products. Any other uses are not permitted and may represent a violation of Gravitech copyrights, legally punishable according to Federal copyright or intellectual property laws. Any duplication of this documentation for commercial uses is expressly prohibited by Gravitech.

Disclaimer

Gravitech is not responsible for special, incidental, or consequential damages under any legal theory, including lost profits, downtime, goodwill, damage to or replacement of equipment or property. Gravitech is also not responsible for any personal damage, including that to life and health, resulting from use of this product. The user takes full responsibility for each SLCD-3 application, no matter how life-threatening it may be.

Warranty

Gravitech warrants this product against defects in materials and workmanship for a period of 15 days. If you discover a defect, we will, at our option, repair, replace, or refund the purchase price. Return the product with a description of the problem. We will return your product or its replacement via standard shipping. Expedited shipping is available at the customer's expense. Please contact us at support@gravitech.us for a RMA# prior to send the return unit back.

- Note: Abusing the module, or attempting to repair or modify it, voids this warranty.

Trademarks

PIC® is a registered trademark of Microchip Technology Incorporated; BASIC Stamp® is a registered trademark of Parallax Inc. All trademarked names referenced herein are the property of their respective holders.



What's new!

New features of SLCD-3 including:

- Big Number Mode
- Custom Text Screen
- Boot Screen Selection

1. Introduction

Your SLCD-3 has the following features:

- Low cost
- Compatible with any industrial standard HD44780 Character LCD with single row connection.
- Configurable for many LCD geometry included: 2x16, 2x20, 2x24, 2x40, 4x16 and 4x20.
- Built-in font with provision for up to 8 user-defined characters
- Fixed baud rate at 9600
- Communicate over serial UART TTL (+5V and 0V) or USB interface
- On USB version, a feature of communicates over the USB with miniB USB connector is added. The unit can be powered directly from the USB port (no external power needed). Drivers are available for Windows 98, 98SE, ME, 2000, Server 2003, XP, Vista, XP Embedded and CE.NET 4.2 & 5.0. Mac OS8/9, OS-X and Linux 2.4 and greater are supported.
- Fully buffered up to 64 character so that no delays in transmission should be necessary
- Hardware controlled contrast
- Software controlled backlight intensity
- Master reset pin
- 4 general purpose outputs for a variety of applications
- Programmable tab size and cursor style
- On-board speaker (beeper)
- Big Number Mode
- Custom Text Screen

The SLCD-3 is designed as the display unit for an associated controller. The controller may be anything from a single board, special purpose microcontroller to a PC, depending on the application. This controller is responsible for what you see on the LCD screen.

The SLCD-3 provides a simple command structure to allow text to be displayed on the screen. Text fonts are built in, and use standard ASCII mapping. Provision is made for up to 8 user-defined characters.

On a non-USB version, the serial UART interface is TTL. That is, the idle state is a TTL logic one, or near +5VDC. This is often termed non-inverting or true. This provides direct compatibility with the UART associated with a PIC[®], 8051, 68HCxx, Z80, SerOut on a Basic Stamp[®], and Com3 on a BX24. The board rate is fixed at 9600. Virtually any application can support 9600 baud.

For a USB version, the feature of USB to serial UART is added. By connecting the unit with the computer via USB A to miniB cable, a virtual COM port on the computer is created. User may use any favorite terminal programs (i.e. Hyperterminal, Putty, TeraTerm or etc.) to communicate directly to SLCD-3 unit. A custom program can be written to communicate the SLCD-3 via a virtual COM port. Essentially this is a direct way to interface with a computer. The unit can also be powered with the USB port from the computer (hardware jumper).

The SLCD-3 is compatible with any industrial standard HD44780 Character LCD with single row connection. The software configuration supported many LCD geometry included: 2x16, 2x20, 2x24, 2x40, 4x16 and 4x20.

The SLCD-3 provides for variable backlight intensity. The backlight current is controlled by a MOSFET. The maximum backlight intensity is controlled with a series limiting resistor. Also, the contrast can be adjust through a potentiometer.

The SLCD-3 provides a 64 character buffer. However, to avoid framing errors, it is suggested the user initially provide a one millisecond delay between each character.

The SLCD-3 provides an on-board buzzer for 50 ms beeping.

A source of +5 VDC with a minimum current of 20 mA is required for this unit.

2. Connection

Connector Pinout

Please refer to the diagram below.

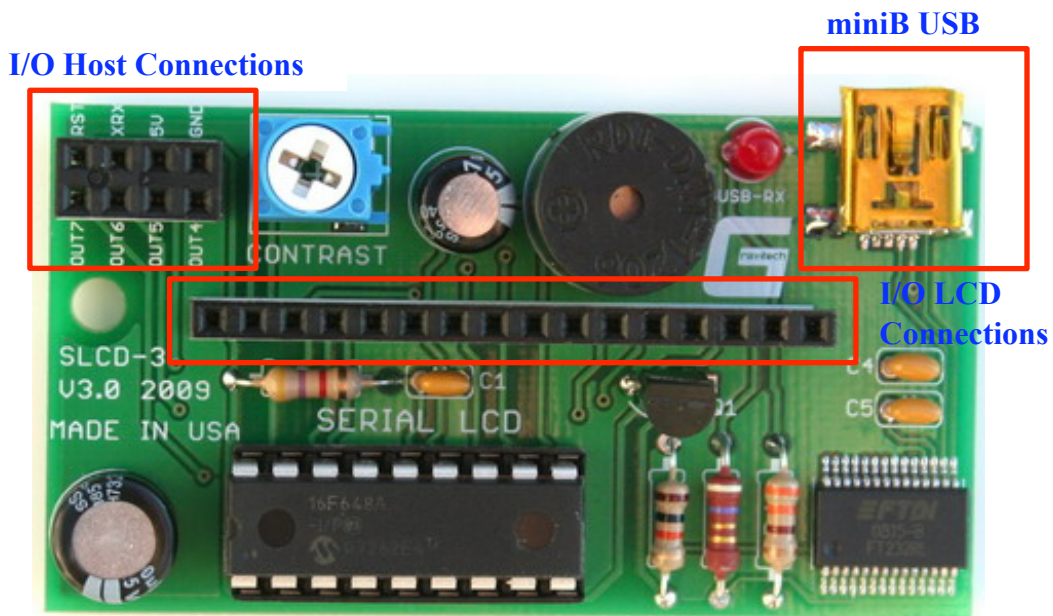

Fig. 1: Electrical Connections

The SLCD-3 has three connectors:

<u>Connector</u>	<u>Function</u>
8 pins dual row-host connections	Host Input/output interface
miniB USB	USB connection (USB version only)
16 pin header	Input/output LCD interface

Power Connections

For a non-USB version, the only way to power the unit is through pin6 (+5V) and pin8 (common ground) on the I/O host connections see Fig. 2. Make sure the “Power” jumper is on the “EXT” as shown in Fig. 3 (See assembly manual for more detail). Power requirement is +5 VDC +/- 0.25V @ 20mA minimum (depend on an LCD).

For a USB version, there are two ways to power the unit by using external or USB power. Follow above step for an external power. For USB power, make sure the “Power” jumper is on “USB” as shown in Fig.4.

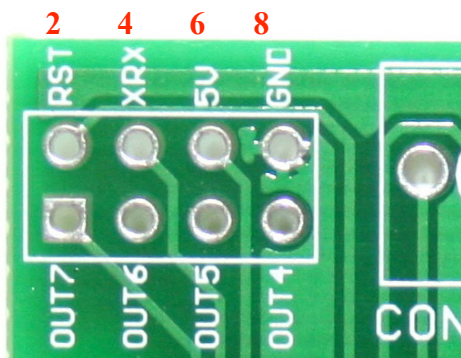

1 3 5 7
Fig. 2: Input/Output host interface

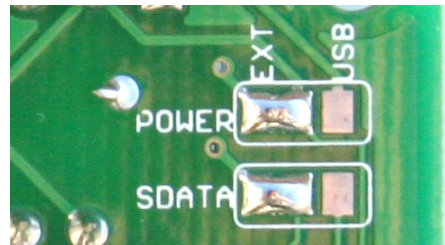

Fig. 3: External power jumper

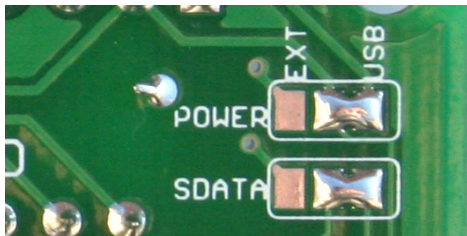

Fig. 4: USB power jumper

Warning:

- **Do not apply any power with reversed polarization.**
- **Do not apply any voltage other than the specified voltage.**

Serial UART TTL Connections

The serial TTL interface idle state is logic one, or near +5 VDC. This provides direct compatibility with the UART on variety of the microcontrollers (i.e. PIC, 8051, 68HCxx, Z80, AVR, SerOut on a Basic Stamp, Com3 on a BX24, etc.). Direct connection can be made via XR_x (pin4) and GND (pin8) on the I/O host connections as shown in Fig. 5. Make sure the “SDATA” jumper is on “EXT” as shown in Fig.3 and 9600 baud is use for communication.

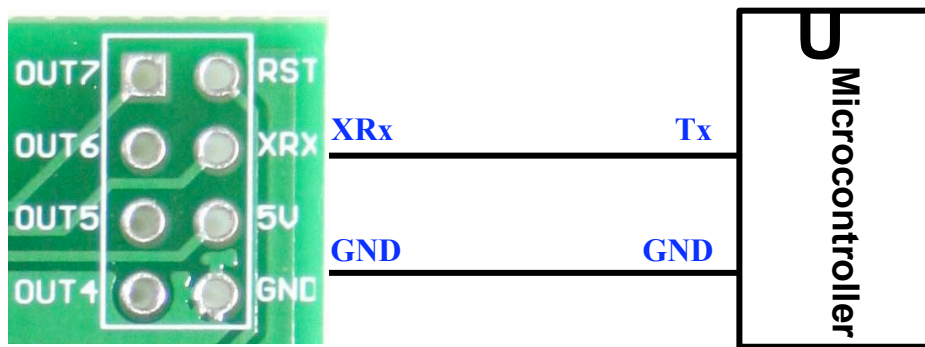

Fig. 5: UART connection

USB communication

Go to the FTDI website www.ftdichip.com and click on the “Drivers” tab. Choose VCP (Virtual COM Port) drivers. Save the appropriate .exe or .zip file for your operating system to disk. Remember the directory (path and folder). After the file has been downloads, double click on the .exe file and the installation process start automatically. Once the installation is completed, check and make sure the “SDATA” jumper is on “USB” as shown in Fig.4. You are ready to plug SLCD-3 to your computer. Open the Device Manger (for Windows XP, located in “Control Panel\System” then selects the “Hardware” tab and click “Device Manage”). Expand “Ports (COM and LPT)” by clicking on the “+” symbol. Note the number of the COM port for the USB Serial Port, see Fig.6.

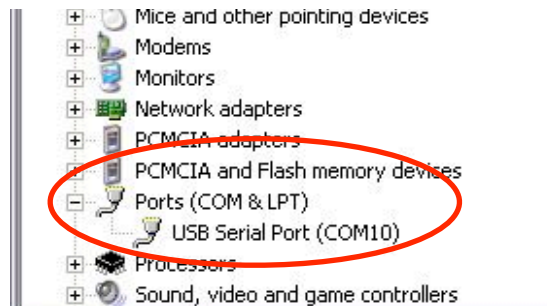

Fig. 6: Virtual COM Port number

General Purpose Outputs

The SLCD-3 has four general purpose TTL outputs. These are provided to control other electronic devices. This allows external devices to be turned on or off using your computer or microcontroller. Any of these outputs, OUT4-OUT7, may be brought high or low using the ‘H’ and ‘L’ commands. (See sections 5 for command syntax)

On power up, all outputs are at high impedance. As each output is addressed, it is taken out of the high impedance state. The initial high impedance state permits the user to use either pull up or pull down resistors to avoid “bounce” when the unit is powered.

General purpose outputs, OUT4-OUT7, are connecting via I/O Host Connections pin 7, 5, 3 and 1 respectively. (See Fig. 3 for I/O Host Connections pinout) **The current (source or sink) by any output should be limited to 15 mA. The common ground (pin8) must be connected to the device using OUT4-OUT7.**

Beeper

The SLCD-3 provided an on-board beeper. The beeper command causes a 50 ms burst of nominally 500 Hz on the beeper. This also causes the backlight to turn off for 50 ms. Care must be take when using this command, in order to protect the over run serial receive buffer, a 50 ms pause is required.

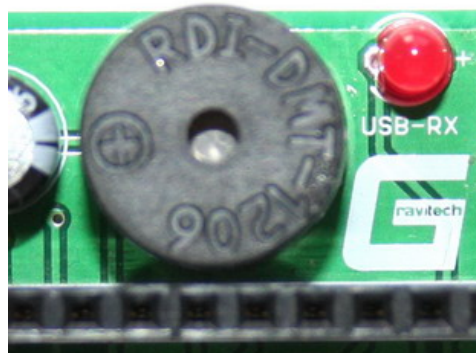

Fig. 7: On-board beeper

I/O LCD Connections

The SLCD-3 is compatible with an industry standard HD44780 Character LCD with single row connection. The software configuration supported many LCD geometry included: 2x16, 2x20, 2x24, 2x40, 4x16 and 4x20. The SLCD-3 is using a parallel 4 interface. Make sure to connect pin1 on the I/O LCD connections of the SLCD-3 to pin1 of the compatible LCD. Please consult the schematic for more detail.

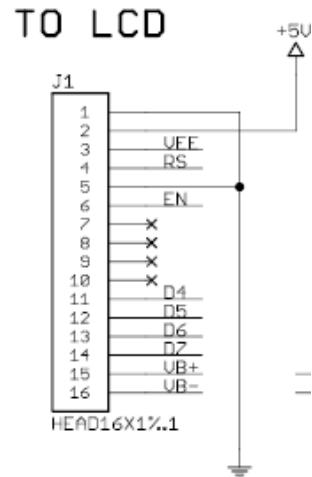

Fig. 8: Schematic of I/O LCD Connections

Contrast adjustment

The SLCD-3 provided the capability of contrast adjustment through a potentiometer. To adjust the contrast, tune the potentiometer with a small screw driver until the best contrast is displayed. Figure 9 shows the contrast potentiometer.



Fig. 9: Contrast potentiometer

USB Communication Status LED (USB version only)

The SLCD-3 provided a USB Communication Status LED. This is a red LED next to the USB connector. It is blinking once the serial data has been received. This is a great feature for diagnostic.

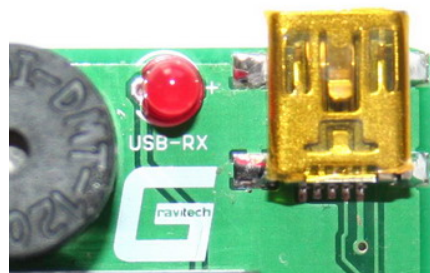

Fig. 10: USB Communication Status LED

3. Displaying Text

This chapter describes the various text-display commands in detail. A quick reference summary of all text commands is found in section 6.

General

Text is displayed on the SLCD-3 using built-in 5 x 7 dot matrix font (plus up to 8 user-defined characters).

The Built-In Character Font

The SLCD-3 includes a built-in 5 x 7 dot matrix font with the full range of ASCII characters plus a variety of extended characters, as shown in Fig. 11.

Lower 4 Bits \ Upper 4 Bits	0000	0001	0010	0011	0100	0101	0110	0111
xxxx0000	CG RAM (1)			0	@	P	`	P
xxxx0001	(2)		!	1	A	Q	a	q
xxxx0010	(3)		"	2	B	R	b	r
xxxx0011	(4)		#	3	C	S	c	s
xxxx0100	(5)		\$	4	D	T	d	t
xxxx0101	(6)		%	5	E	U	e	u
xxxx0110	(7)		&	6	F	V	f	v
xxxx0111	(8)		'	7	G	W	g	w
xxxx1000	(1)		(8	H	X	h	x
xxxx1001	(2))	9	I	Y	i	y
xxxx1010	(3)		*	:	J	Z	j	z
xxxx1011	(4)		+	;	K	L	k	l
xxxx1100	(5)		,	<	L	¥	l	l
xxxx1101	(6)		-	=	M	J	m	}
xxxx1110	(7)		.	>	N	^	n	+
xxxx1111	(8)		/	?	O	_	o	€

Fig. 11: Character Set

In addition to the built-in characters, users may define up to 8 special characters. The SLCD-3 does not have provision to download other fonts.

Writing Text to the Display

When the display receives a character, it displays that character at the position currently defined. The next character sent to the module then advances to the following position on the display. The unit built in with the automatic line wrapping. Note that this is not “word wrapping” and wraps may occur in the middle of a word. Characters are drawn using the built-in font, and only characters defined in the font are actually displayed.

The position where text is to be inserted is a character location stored in the SLCD-3 volatile memory and maintained internally by the SLCD-3 firmware. **The default is a tab size of 4, a full blinking cursor (3) and the eight special characters consisting of a single horizontal line, two horizontal lines, etc.**

All of these parameters may be modified. Note that when the modifications are made, the new values are written to the processor’s EEPROM. Thus, the user defined characters need only be modified one time. This position is manipulated by the commands shown in the following section.

Set cursor position (?x[column], ?y[row])

This command sets the cursor position to the [column] and [row] specified. Columns have values from 00 to 19 and rows have values of 0 to 3. (i.e. **?y2?x08** position the cursor at column 8 of line 2.)

Note that the line and column numbers begins with 0.

Send cursor home (?a)

This command moves the cursor position to the top left of the display area.

Cursor left (?h)

This command moves the cursor one position to the left but does not erase any character that may be in that position. Note: For a “destructive backspace”, use command **?b**.

Cursor right (?i)

This command moves the cursor one position to the right but does not erase any character that may be in that position.

Destructive backspace (?b)

This command moves the cursor one position to the left and erases any character that may be in that position.

Clear line (?l)

This command clears current line and leave cursor at the beginning of the line.

Clear screen (?f)

This command clears the LCD and leave cursor at home position (top left of the display area).

Cursor up (?k)

This command moves the cursor up one position but does not erase any character that may be in that position.

Cursor down (?j)

This command moves the cursor down one position but does not erase any character that may be in that position.

Carriage return (?m)

This command moves the cursor to the beginning of the line but does not erase any character that may be in that position.

New line (?n)

This command advances the cursor to the beginning of the line and clears this line.

Tab (?t)

This command advances the cursor one tab, and any characters in its path are overwritten with a space. For example, if the cursor is in column 3 and the tab size is 5, the cursor will advance to column 5. Anything in column 3 and 4 will be replaced with spaces.

Note that all of the commands are starting with ?, to display “?” character, ?? is used.

Configure for LCD geometry (?G)

This command configures LCD geometry. Supported formats are 2x16, 2x20, 2x24, 2x40, 4x16 and 4x20. (i.e. ?G216 configure driver for 2x16 LCD)

4. Power up selftest and Special Characters

Power up selftest

Once the power is applied to SLCD-3, the LCD displays the geometry of the LCD, the tab size, eight user defined characters and a blinking cursor. The unit is shipped with a 4 x 20 geometry, a tab size of 4, user defined characters of a single row of pixels, two rows, three rows, etc and a blinking cursor.

This screen message appears for about two seconds and the LCD is cleared and the cursor is positioned at the home position. The LCD is now awaiting the receipt of characters to display.

If the message does appear, it verifies that both the daughter and the LCD are operational and the associated wiring is correct.

Special Characters

The SLCD-3 allows user to define up to eight special characters. The characters may be defined or redefined at any time by issuing the commands shown in this section.

The SLCD-3 allows up to 8 user defined (custom) characters. Custom characters occupy a 5 x 8 pixel matrix.

The characters are defined by issuing the command **?D** followed by 8 bytes to define the character. Use Table 1 to help define the custom characters.

Table 1: Define a Custom Characters

D7	D6	D5	D4	D3	D2	D1	D0	Data Byte	HEX number
MSB							LSB		
*	*	*						Data Byte 1	
*	*	*						Data Byte 2	
*	*	*						Data Byte 3	
*	*	*						Data Byte 4	
*	*	*						Data Byte 5	
*	*	*						Data Byte 6	
*	*	*						Data Byte 7	
*	*	*						Data Byte 8	

A “1” bit indicates an on (black) pixel, a “0” bit indicates an off (clear) pixel. Table 2 shown the example of custom defines character.

Table 2: Example of a Custom Character

D7	D6	D5	D4	D3	D2	D1	D0	Data Byte	HEX number
MSB							LSB		
*	*	*						Data Byte 1	00
*	*	*						Data Byte 2	00
*	*	*		■		■		Data Byte 3	0a
*	*	*	■		■		■	Data Byte 4	15
*	*	*	■				■	Data Byte 5	11
*	*	*		■		■		Data Byte 6	0a
*	*	*			■			Data Byte 7	04
*	*	*						Data Byte 8	00

To define the example shown in Table 2 in user define character 3, the following command is used: **?D30000a15110a0400**

The number after the ‘D’ is the number associated with the user defined character, in this case user defined character 3. This is then followed by the eight data bytes expressed in two digit hexadecimal. **Note that the hexadecimal letters must be lower case.**

Thus, when user defined character 3 is displayed using the command **?3**, a character consisting of the heart shape will be displayed.

Each user defined character is saved in EEPROM. The design provides a 64 byte serial receive buffer. However, be careful. If one is defining all eight user defined characters, this involves sending 19 * 8 or 152 characters. Writing each of the eight bytes to EEPROM requires 15 ms or more and thus, one can easily over run buffer. Rather, provide a one second delay after defining each character.

User may use software, LCDCC.exe, to help create the user define characters. LCDCC is a property of Parallax Inc. and can be downloading for free from www.parallax.com. For convenient, version 0.95 (Beta) can be download from our product page. All of the software goods is credited to Parallax Inc. and intended to be used for educational purposes only.

5. Big Number Mode



The SLCD-3 design provides both three and four block wide characters. The big number mode is entered;

?>3 or ?>4

On receipt of either of the ?>3 or ?>4 commands, the processor will download to the LCD the special required to display the big numbers. These are probably different from any user defined characters which the user may have defined. Thus, don't display your user defined characters when displaying in the "big number" format.

The cursor is then located on the top row of the current column. Figure 12 shown example of big number mode.



Fig. 12: Big number mode

In the >3 mode, as each numeric digit is received, it will erase anything appearing in the three column wide by four high space and display the number in the big number format. In addition, it will clear the column to the right of the character. The cursor will then be located at the top row for display of the next digit. Note that for the three block wide mode, this is four columns to the right of the upper left of the previous character. Thus, each digit uses four columns, three for the display of the digit and one for the spacing between digits.

Display of the minus sign, colon and decimal point use two columns, one for the display of the symbol plus one space.

The >4 mode is similar, except that each digit is four wide plus one space.

There is no intelligent "wrapping" provision for the "big number" mode. Thus, if there are only two columns remaining before the end of the LCD and you attempt to display a "7", part of the "7" will appear on the right side of the LCD, and the rest on the beginning of the display.

The big number mode may be exited at any time:

?<

This may be used to display ordinary text along with the "big number" characters. For example, shown in Fig. 13, the message "4X4 Demo" appears. This might be done;

?y0?x164X4 ' row 0, beginning at column 16

?y1?x16Demo ' row 1, beginning at column 16

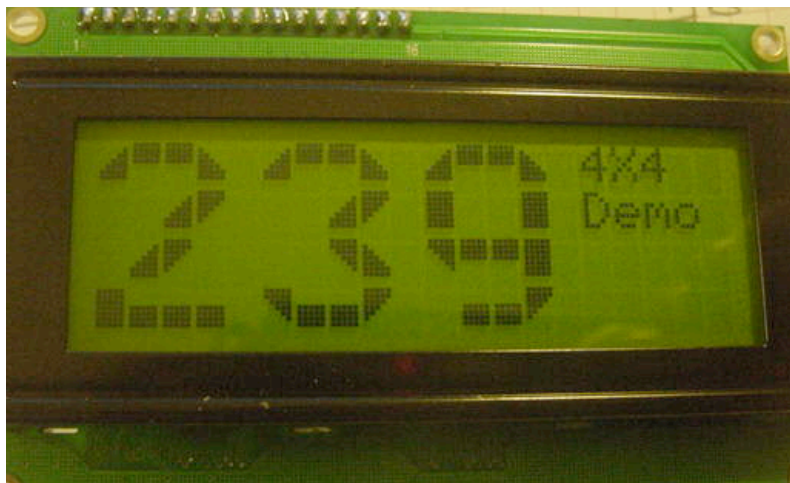

Fig. 13: Mixed big number and ordinary text mode

Note that the **?<** command simply exits the "big number" mode. It does not download the user defined characters that might be used for graphics.

If one later wishes to use the user defined characters;

?R ' restore the user defined characters.

Again, note that the characters associated with the display of the "big number" characters are not compatible with the user defined characters one might use for plotting and thus, "big numbers" and graphics type applications using specially defined characters cannot coexist on the display.

6. Custom Text Screen



The customized text screen may be an advertisement which is displayed on boot or a template which may be displayed at any time. It is set using the **?C** command, followed by the row, followed by the twenty characters which are to appear on the row. For example, the following sequence defines the custom screen shown in Fig. 14.

```
?C0abcdefghijklmnopqrst  
?C1ABCDEFGHIJKLMNQRST  
?C201234567890123456789  
?C398765432109876543210
```

Note that this custom screen may be displayed at any time;

?*



Fig. 14: Example of custom text screen

7. Boot Screen Selection



The screen which is displayed on boot may be specified using the **?S** command followed by a number, 0, 1 or 2.

- ?S0** ' display no screen on boot.
- ?S1** ' display the configuration setting on boot
- ?S2** ' display the user custom text screen on boot.

8. Miscellaneous Commands

The commands listed in this chapter do not readily fit in any of the other categories, or are used in more than one category.

Set tab size (?s[tab size])

This command sets the tab size. Valid values of the tab are 1-8. When this command is received by the processor, the new tab size is written to EEPROM and this value is used thereafter when executing the **?t** command. For example, **?s5** set tab size to five.

Set backlight intensity (?B[backlight intensity])

This command adjusts the intensity of an LED backlight on the display. The digits following the “B” are two digit hexadecimal, ranging from 00 (backlight off) to FF (backlight fully on). For example, **?B80** sets backlight intensity to half way on and **?BFF** or **?Bff** sets backlight intensity to fully on.

Set cursor style (?c[cursor style])

This command sets the cursor style. The number is in the range of 0-3. A 0 configures are no cursor, a 2 as a non blinking cursor and a 1 or 3 as a blinking cursor. The style of the cursor is saved to EEPROM.

General Purpose Outputs (?H[output port] and ?L[output port])

This command turns ON (high) and OFF (low) any of the General Purpose Outputs. The SLCD-3 provides four general purpose TTL outputs. Any of these outputs, 4-7, may be brought high or low using the ‘H’ and ‘L’ commands. For example, **?H4?L7** brings output 4 high and output 7 low. **Note that outputs 0, 1, 2 and 3 are not valid.**

Beep (?g)

This command causes a 50 ms burst of nominally 500 Hz on the on-board beeper. (See Fig. 7)

Direct Control of the LCD (?![command])

This command passes the direct command to the LCD. [command] is a two digit hexadecimal number. Caution: with all other commands the firmware keeps track of the current cursor position. This is not done with commands sent directly to the LCD using the **?!** command. Thus, if the user configures the LCD such that the cursor is located at some point, subsequent line feeds and similar will not work correctly as the program does not know the current cursor location. **CAUTION: Use of this command may give unpredictable results.**

9. Appendix A: Command Summary

Command	Syntax	Default	Notes
Set cursor position	?x[<i>col</i>] ?y[<i>row</i>]	Home	Move cursor to the specified column and row.
Send cursor home	?a		Moves the cursor to the top left of the display area.
Cursor left	?h		Moves the cursor one position to the left. If the cursor is already at the beginning of a line it will move to the end of the other line.
Cursor right	?i		Moves the cursor one position to the right. If the cursor is already at the end of a line it will move to the beginning of the other line.
Destructive backspace	?b		Moves the cursor one position to the left and erases any character that may be in that position.
Clear line	?l		Clears current line and leave cursor at the beginning of the line.
Clear screen	?f		Clears the LCD and leave cursor at home position (top left).
Cursor up	?k		Moves the cursor up one position.
Cursor down	?j		Moves the cursor down one position.
Carriage return	?m		Move the cursor to the beginning of the line.
New line	?n		Advances the cursor to the beginning of the line and clear this line.
Tab	?t		Advances the cursor one tab, and any characters in its path are overwritten with a space.
Set tab size	?s[<i>tab size</i>]	4	Sets the tab size. Valid [<i>tab size</i>] are 1-8.
Set backlight intensity	?B[<i>inten</i>]	00	Adjusts the intensity of an LED backlight on the display. [<i>inten</i>] are two digit hexadecimal, ranging from 00 (backlight off) to FF (backlight fully on).
Set cursor style	?c[<i>style</i>]	03	Sets the cursor style. [<i>style</i>] is range from 0-3. A 0 configures are no cursor, a 2 as a non blinking cursor and a 1 or 3 as a blinking cursor.

General purpose outputs	?H[port] ? L[port]	High impedance	Turns a general purpose output ON or OFF. [port] may be from 4 to 7. See section 2 for further details.
Beep	?g		Causes a 50 ms burst of nominally 500 Hz on I/O socket pin 13.
Define custom character	?D[n][8 bytes]	Horizontal line(s)	Defines on of 8 custom user characters. Character number is [n] between 0 to 7. The 8 bytes are described in section 4.
Use custom character	? [n]		Displays the custom user characters. Character number is [n] between 0 to 7.
Big number mode 3	?>3		Enter big number mode, three block wide.
Big number mode 4	?>4		Enter big number mode, four block wide.
Restore the user defined characters	?R		Restore the user defined characters after exit out of big number mode.
Custom text screen	?C[row] [20 bytes]		Customize text screen. [row] is a digit number between 0 to 3.
Display customized text screen	?*		Display customized text screen at any time.
Boot screen selection	?S[n]		Select the screen which is displayed on power up selftest. Character number is [n] between 0 to 3.
Direct control of the LCD	?! [byte]		Passes the direct control to the LCD. [byte] is a two digit hexadecimal number.
Configure for LCD geometry. Supported formats: 2x16, 2x20, 2x24, 2x40, 4x16 and 4x20.	?G	4x20	This command configures LCD geometry. (i.e. ?G216 configure driver for 2x16 LCD)

10. Appendix B: Optional parts (Optional part, doesn't come with the kit)

There are several ways to make connection to the SLCD-3 board.

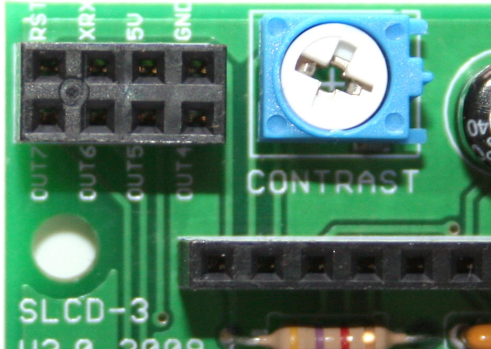

1) Use 4x2 female headers
(P/N [4Fx2-254mm](#)).

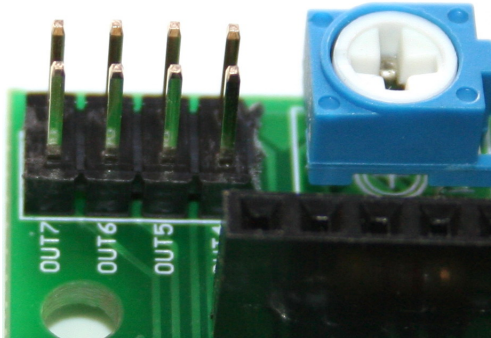

2) Use 4x2 male headers
(P/N [20Mx2-254mm](#))

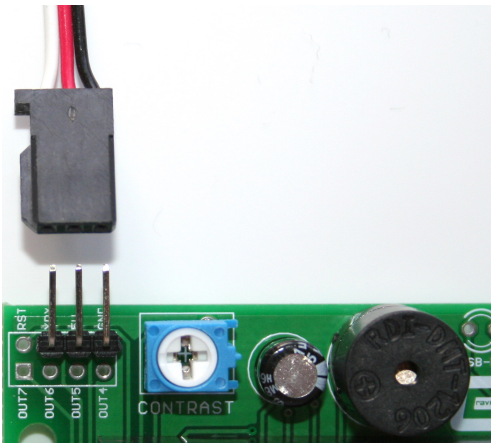

3) Use 3x1 right angle male headers
with servo cable.
(P/N [20Mx1RA-254mm](#) for the
headers)

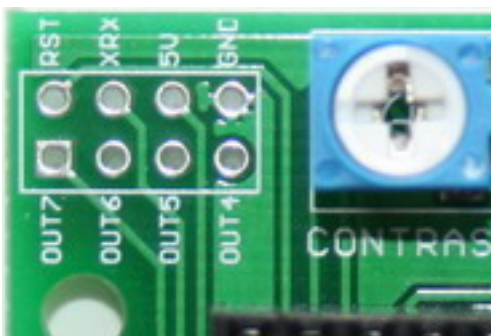

4) Solder wires directly to the pads.

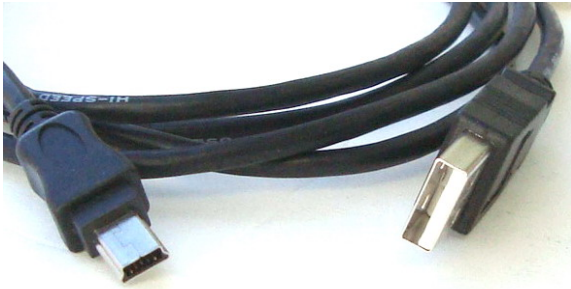

For USB version, USB A to miniB cable is needed.

[3Ft USB A to miniB cable](#)

[6Ft USB A to miniB cable](#)

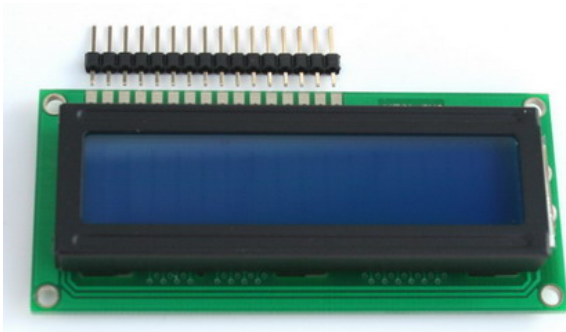

[16x2 Character Blue LCD with Backlight](#)

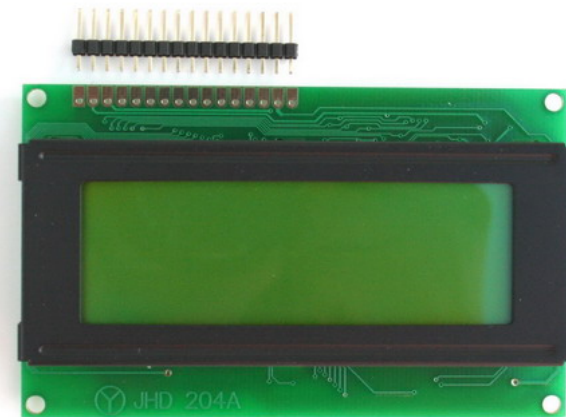

[20x4 Character Yellow/Green LCD with Backlight](#)

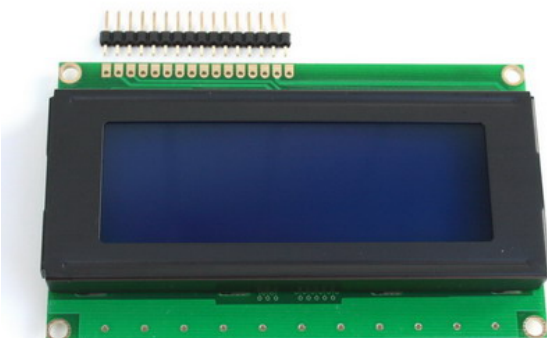

[20x4 Character Blue LCD with Backlight](#)

Данный компонент на территории Российской Федерации

Вы можете приобрести в компании MosChip.

Для оперативного оформления запроса Вам необходимо перейти по данной ссылке:

<http://moschip.ru/get-element>

Вы можете разместить у нас заказ для любого Вашего проекта, будь то серийное производство или разработка единичного прибора.

В нашем ассортименте представлены ведущие мировые производители активных и пассивных электронных компонентов.

Нашей специализацией является поставка электронной компонентной базы двойного назначения, продукции таких производителей как XILINX, Intel (ex.ALTERA), Vicor, Microchip, Texas Instruments, Analog Devices, Mini-Circuits, Amphenol, Glenair.

Сотрудничество с глобальными дистрибьюторами электронных компонентов, предоставляет возможность заказывать и получать с международных складов практически любой перечень компонентов в оптимальные для Вас сроки.

На всех этапах разработки и производства наши партнеры могут получить квалифицированную поддержку опытных инженеров.

Система менеджмента качества компании отвечает требованиям в соответствии с ГОСТ Р ИСО 9001, ГОСТ РВ 0015-002 и ЭС РД 009

Офис по работе с юридическими лицами:

105318, г.Москва, ул.Щербаковская д.3, офис 1107, 1118, ДЦ «Щербаковский»

Телефон: +7 495 668-12-70 (многоканальный)

Факс: +7 495 668-12-70 (доб.304)

E-mail: info@moschip.ru

Skype отдела продаж:

moschip.ru

moschip.ru_4

moschip.ru_6

moschip.ru_9