



Main

Range of product	OsiSense XU
Series name	Application packaging
Electronic sensor type	Photo-electric sensor
Sensor name	XUK
Sensor design	Compact 50 x 50
Detection system	Reflex
Material	Plastic
Type of output signal	Discrete
Supply circuit type	DC
Wiring technique	3-wire
Discrete output type	PNP or NPN
Discrete output function	1 NO or 1 NC programmable
Electrical connection	Cable
Cable length	6.56 ft (2 m)
Product specific application	Detection of transparent object
Emission	Red reflex
[Sn] nominal sensing distance	4.92 ft (1.5 m) reflex need reflector XUZC50

Complementary

Enclosure material	PC
Lens material	PMMA
Output type	Solid state
Output function governance	Dark
Add on output	Without
Cable composition	2 x 0.34 mm ²
Wire insulation material	PVC
Cable outer diameter	0.24 in (6 mm)
Status LED	1 LED output state
[Us] rated supply voltage	12...24 V DC with reverse polarity protection
Supply voltage limits	10...30 V AC/DC
Switching capacity in mA	<= 100 mA (overload and short-circuit protection)
Switching frequency	<= 1.5 kHz
Voltage drop	<= 2 V (closed state)
Current consumption	<= 35 mA (no-load)
Time delay range	0.1...5 s monostable, on-delay or off-delay (programmable) delay
Delay first up	<= 80 ms
Delay response	<= 0.3 ms
Delay recovery	<= 0.3 ms
Setting-up	Sensitivity adjustment by potentiometer
Depth	1.97 in (50 mm)
Height	1.97 in (50 mm)
Width	0.71 in (18 mm)
Product weight	0.08 lb(US) (0.035 kg)
Kit composition	Sensor Bracket XULZ41

Environment

product certifications	CE
------------------------	----

CSA
UL

ambient air temperature for operation	-13...131 °F (-25...55 °C)
ambient air temperature for storage	-40...158 °F (-40...70 °C)
vibration resistance	7 gn, amplitude = +/- 2 mm (f = 10...55 Hz) conforming to IEC 60068-2-6
shock resistance	20 gn (duration = 11 ms) conforming to IEC 60068-2-27
IP degree of protection	IP651 conforming to NF C 20-010 IP65 conforming to IEC 60529

Offer Sustainability

Not Green Premium product	Not Green Premium product
Compliant - since 0841 - Schneider Electric declaration of conformity	Compliant - since 0841 - Schneider Electric declaration of conformity
Available	Available
Available	Available
WARNING: This product can expose you to chemicals including:	WARNING: This product can expose you to chemicals including:
Diisononyl phthalate (DINP), which is known to the State of California to cause cancer, and	Diisononyl phthalate (DINP), which is known to the State of California to cause cancer, and
Di-isodecyl phthalate (DIDP), which is known to the State of California to cause birth defects or other reproductive harm.	Di-isodecyl phthalate (DIDP), which is known to the State of California to cause birth defects or other reproductive harm.
For more information go to www.p65warnings.ca.gov	For more information go to www.p65warnings.ca.gov

Contractual warranty

Warranty period	18 months
-----------------	-----------

Dimensions

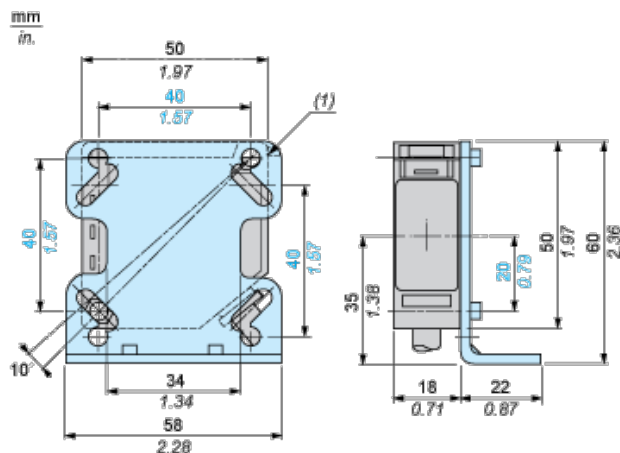

- (1) Cover locking tongue

Bracket Fixing

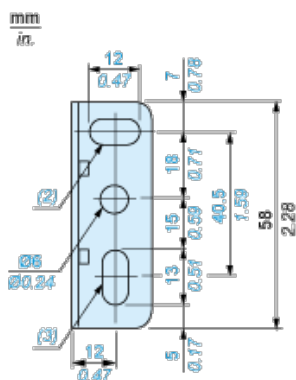

- (2) 1 elongated hole \varnothing 6 x 12
(3) 1 elongated hole \varnothing 6 x 13

Wiring Schemes

Connector Scheme

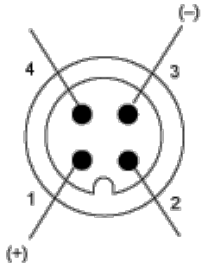

- 1 : (+)
- 2 : Alarm output
- 3 : (-)
- 4 : Output signal

NC Programmed

PNP programmed output

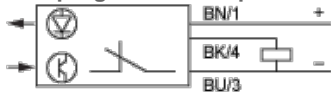

- BN : Brown
- BK : Black
- BU : Blue

NPN programmed output

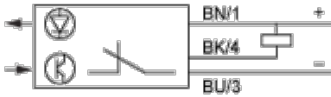

- BN : Brown
- BK : Black
- BU : Blue

NO Programmed

PNP programmed output

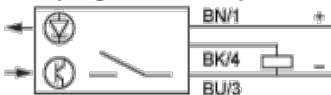

- BN : Brown
- BK : Black
- BU : Blue

NPN programmed output

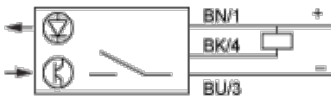

- BN : Brown
- BK : Black
- BU : Blue

Alarm Output

PNP programmed



- BN : Brown
- WH : White
- BU : Blue

NPN programmed

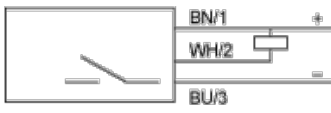

BN : Brown

WH :White

BU : Blue

Данный компонент на территории Российской Федерации

Вы можете приобрести в компании MosChip.

Для оперативного оформления запроса Вам необходимо перейти по данной ссылке:

<http://moschip.ru/get-element>

Вы можете разместить у нас заказ для любого Вашего проекта, будь то серийное производство или разработка единичного прибора.

В нашем ассортименте представлены ведущие мировые производители активных и пассивных электронных компонентов.

Нашей специализацией является поставка электронной компонентной базы двойного назначения, продукции таких производителей как XILINX, Intel (ex.ALTERA), Vicor, Microchip, Texas Instruments, Analog Devices, Mini-Circuits, Amphenol, Glenair.

Сотрудничество с глобальными дистрибьюторами электронных компонентов, предоставляет возможность заказывать и получать с международных складов практически любой перечень компонентов в оптимальные для Вас сроки.

На всех этапах разработки и производства наши партнеры могут получить квалифицированную поддержку опытных инженеров.

Система менеджмента качества компании отвечает требованиям в соответствии с ГОСТ Р ИСО 9001, ГОСТ РВ 0015-002 и ЭС РД 009

Офис по работе с юридическими лицами:

105318, г.Москва, ул.Щербаковская д.3, офис 1107, 1118, ДЦ «Щербаковский»

Телефон: +7 495 668-12-70 (многоканальный)

Факс: +7 495 668-12-70 (доб.304)

E-mail: info@moschip.ru

Skype отдела продаж:

moschip.ru

moschip.ru_4

moschip.ru_6

moschip.ru_9