

9155 MOBO® 3.0mm Pitch Right Angle Battery Connectors

GENERAL DESCRIPTION

A further addition to the battery connector range offered by AVX is a 90 degree version. On a 3mm pitch, offered in 2 to 5 contact positions and rated as with all of the battery range at 3 amps. The connector's design is small and compact to minimize its profile yet stable while having a contact point 4.61mm above the PCB.

The stability comes from the addition of extra SMT anchor brackets that are in between the SMT contact pads and both at the front of the connector and within the row of the contact SMT pads.

As with the other 9155 series of battery connectors offered by AVX the 90 degree version is rated at 3 amps and 5000 mating cycles, RoHS compliant and using high temperature plastic enables the connectors to be processed at up to 260°C.



APPLICATIONS

- Mobile phones
- Digital music players
- Hand held terminals
- Data terminals or any other small portable device

FEATURES AND BENEFITS

- Simple designed spring contact
- End to end stackable for larger pin counts
- Additional contact anchor brackets to added stability on the PCB
- Robust to shock and vibration
- Selectively plated contact area



HOW TO ORDER

00	9155	002	301	XXX																				
Prefix	Series	No. of Ways	Right Angle Battery Connector	Plating Option																				
		<table border="1"> <thead> <tr> <th>Code</th> <th>No. of Ways</th> </tr> </thead> <tbody> <tr> <td>002</td> <td>2</td> </tr> <tr> <td>003</td> <td>3</td> </tr> <tr> <td>004</td> <td>4</td> </tr> <tr> <td>005</td> <td>5</td> </tr> </tbody> </table>	Code	No. of Ways	002	2	003	3	004	4	005	5	<table border="1"> <thead> <tr> <th>Code</th> <th>Description</th> </tr> </thead> <tbody> <tr> <td>301</td> <td>Right Angle 3.00mm Battery Connector</td> </tr> </tbody> </table>	Code	Description	301	Right Angle 3.00mm Battery Connector	<table border="1"> <thead> <tr> <th>Code</th> <th>Description</th> </tr> </thead> <tbody> <tr> <td>006</td> <td>0.4µm Selective Gold, Pure Tin Tail</td> </tr> <tr> <td>008</td> <td>0.8µm Selective Gold, Pure Tin Tail</td> </tr> </tbody> </table>	Code	Description	006	0.4µm Selective Gold, Pure Tin Tail	008	0.8µm Selective Gold, Pure Tin Tail
Code	No. of Ways																							
002	2																							
003	3																							
004	4																							
005	5																							
Code	Description																							
301	Right Angle 3.00mm Battery Connector																							
Code	Description																							
006	0.4µm Selective Gold, Pure Tin Tail																							
008	0.8µm Selective Gold, Pure Tin Tail																							

9155 MOBO[®] 3.0mm Pitch Right Angle Battery Connectors



2 Way Right Angle Battery Connector

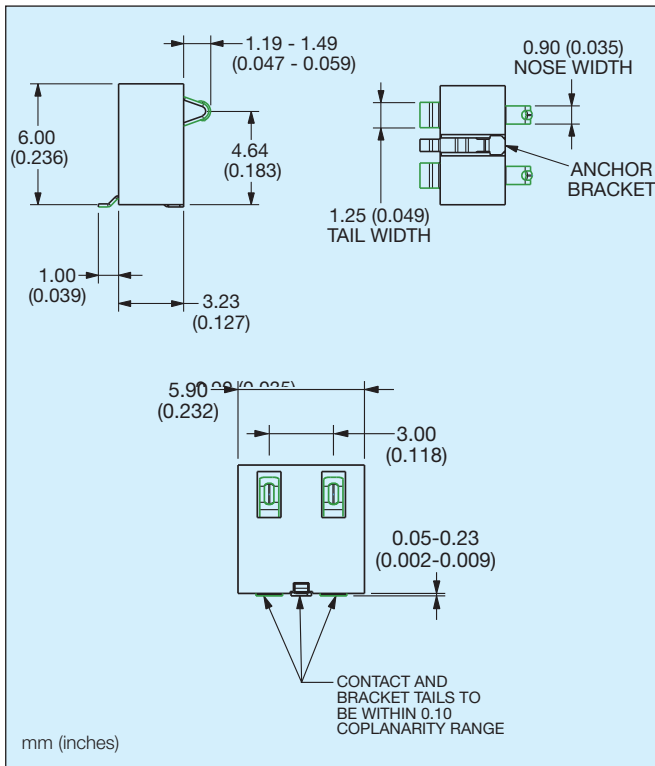

3 Way Right Angle Battery Connector

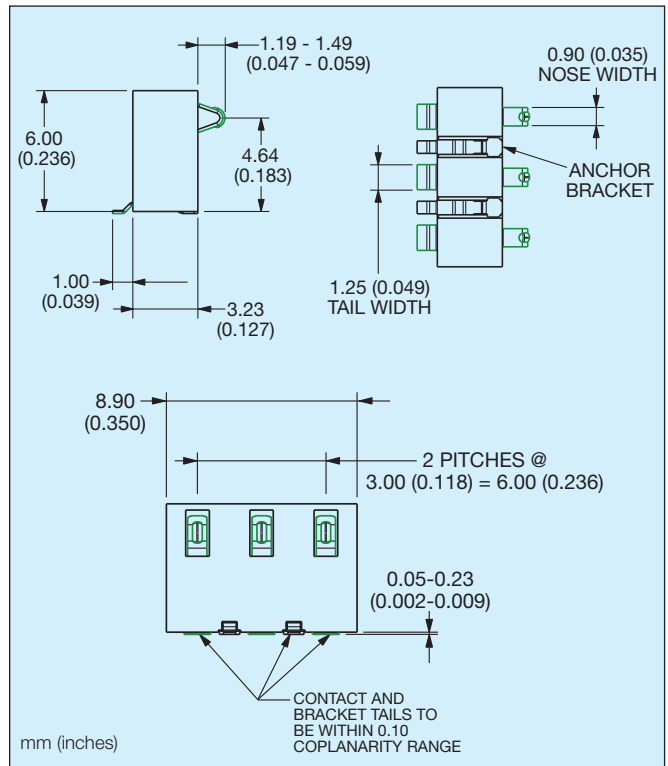

4 Way Right Angle Battery Connector

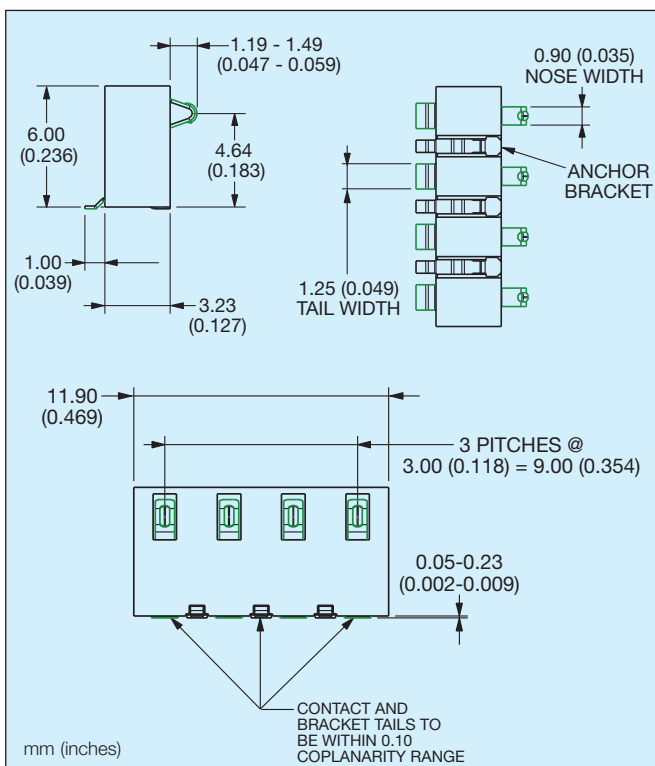

5 Way Right Angle Battery Connector

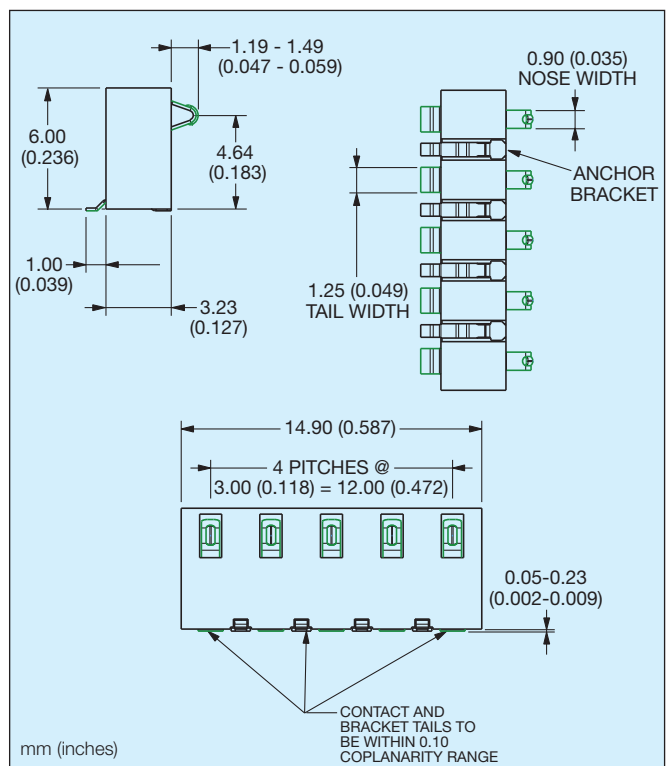

9155 MOBO® 3.0mm Pitch Right Angle Battery Connectors



2 Way Right Angle Battery Connector PCB Layout

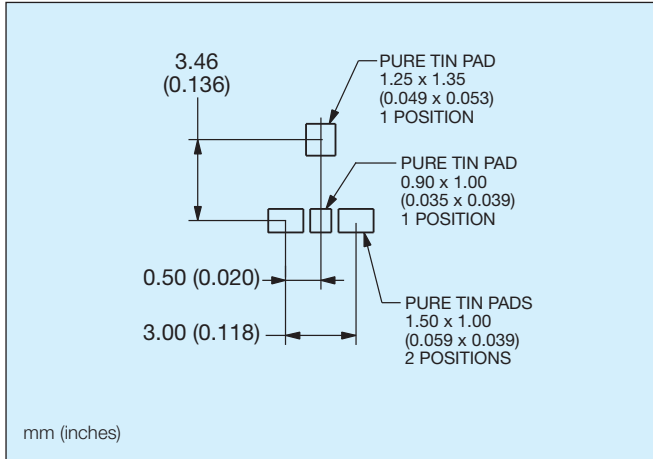

3 Way Right Angle Battery Connector PCB Layout

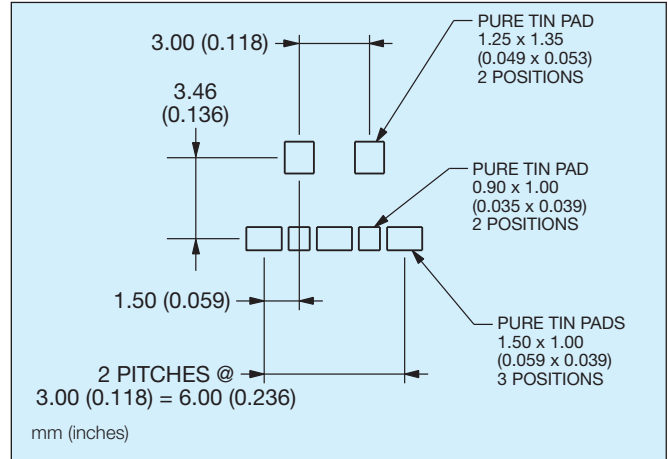

4 Way Right Angle Battery Connector PCB Layout

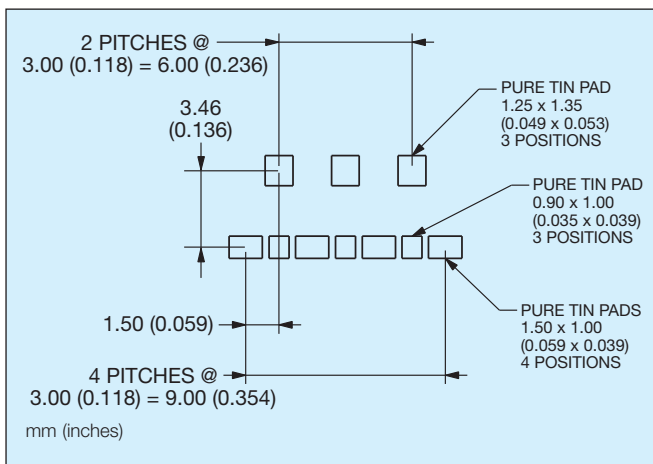

5 Way Right Angle Battery Connector PCB Layout

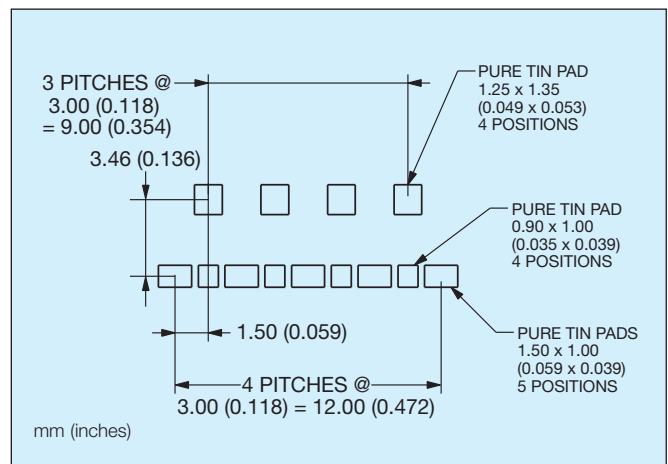

Данный компонент на территории Российской Федерации

Вы можете приобрести в компании MosChip.

Для оперативного оформления запроса Вам необходимо перейти по данной ссылке:

<http://moschip.ru/get-element>

Вы можете разместить у нас заказ для любого Вашего проекта, будь то серийное производство или разработка единичного прибора.

В нашем ассортименте представлены ведущие мировые производители активных и пассивных электронных компонентов.

Нашей специализацией является поставка электронной компонентной базы двойного назначения, продукции таких производителей как XILINX, Intel (ex.ALTERA), Vicor, Microchip, Texas Instruments, Analog Devices, Mini-Circuits, Amphenol, Glenair.

Сотрудничество с глобальными дистрибьюторами электронных компонентов, предоставляет возможность заказывать и получать с международных складов практически любой перечень компонентов в оптимальные для Вас сроки.

На всех этапах разработки и производства наши партнеры могут получить квалифицированную поддержку опытных инженеров.

Система менеджмента качества компании отвечает требованиям в соответствии с ГОСТ Р ИСО 9001, ГОСТ РВ 0015-002 и ЭС РД 009

Офис по работе с юридическими лицами:

105318, г.Москва, ул.Щербаковская д.3, офис 1107, 1118, ДЦ «Щербаковский»

Телефон: +7 495 668-12-70 (многоканальный)

Факс: +7 495 668-12-70 (доб.304)

E-mail: info@moschip.ru

Skype отдела продаж:

moschip.ru

moschip.ru_4

moschip.ru_6

moschip.ru_9