

Part Number: AM23ID-F

High Efficiency Red

### Features

- SOT-23 package surface mount LED lamp.
- Low power consumption.
- Long life - solid state reliability.
- Package: 2000pcs / reel.
- Moisture sensitivity level : level 3.
- RoHS compliant.

### Description

The High Efficiency Red source color devices are made with Gallium Arsenide Phosphide on Gallium Phosphide Orange Light Emitting Diode.

### Package Dimensions

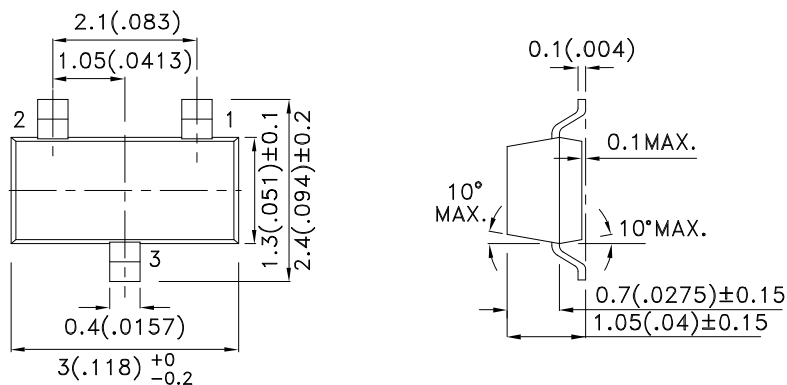

- 1 ANODE
- 2 N.C.
- 3 CATHODE

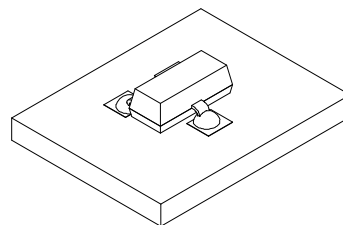

#### Notes:

1. All dimensions are in millimeters (inches).
2. Tolerance is  $\pm 0.25(0.01)$ " unless otherwise noted.
3. Lead spacing is measured where the lead emerge from the package.
4. The specifications, characteristics and technical data described in the datasheet are subject to change without prior notice.
5. The device has a single mounting surface. The device must be mounted according to the specifications.



## Selection Guide

Part No.	Dice	Lens Type	Iv (mcd) [2] @ 20mA		Viewing Angle [1]
			Min.	Typ.	2θ1/2
AM231D-F	High Efficiency Red (GaAsP/GaP)	Red Diffused	5	12	140°

Notes:

1. θ1/2 is the angle from optical centerline where the luminous intensity is 1/2 of the optical peak value.
2. Luminous intensity/ luminous Flux: +/-15%.

## Electrical / Optical Characteristics at TA=25°C

Symbol	Parameter	Device	Typ.	Max.	Units	Test Conditions
λ <sub>peak</sub>	Peak Wavelength	High Efficiency Red	627		nm	I <sub>F</sub> =20mA
λ <sub>D</sub> [1]	Dominant Wavelength	High Efficiency Red	625		nm	I <sub>F</sub> =20mA
Δλ <sub>1/2</sub>	Spectral Line Half-width	High Efficiency Red	45		nm	I <sub>F</sub> =20mA
C	Capacitance	High Efficiency Red	15		pF	V <sub>F</sub> =0V;f=1MHz
V <sub>F</sub> [2]	Forward Voltage	High Efficiency Red	2	2.5	V	I <sub>F</sub> =20mA
I <sub>R</sub>	Reverse Current	High Efficiency Red		10	uA	V <sub>R</sub> =5V

Notes:

1. Wavelength: +/-1nm.
2. Forward Voltage: +/-0.1V.

## Absolute Maximum Ratings at TA=25°C

Parameter	High Efficiency Red	Units
Power dissipation	75	mW
DC Forward Current	30	mA
Peak Forward Current [1]	160	mA
Reverse Voltage	5	V
Operating Temperature	-40°C To +85°C	
Storage Temperature	-40°C To +85°C	

Note:

1. 1/10 Duty Cycle, 0.1ms Pulse Width.



## High Efficiency Red AM23ID-F

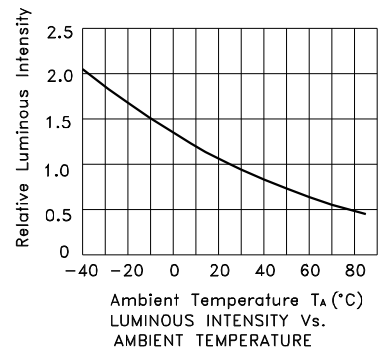
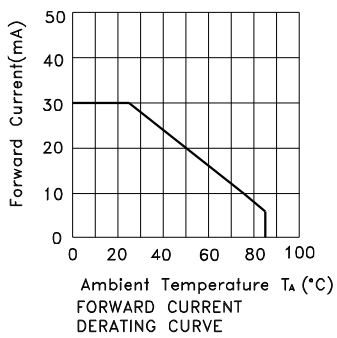
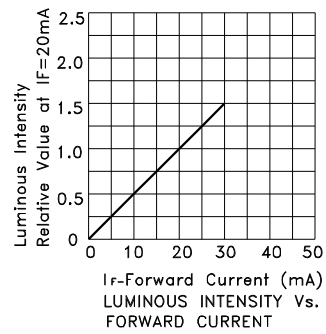
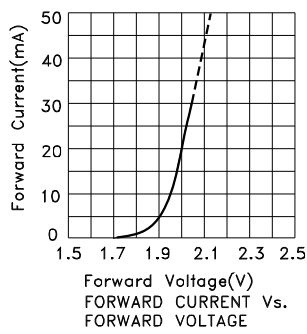

## AM23ID-F

Reflow soldering is recommended and the soldering profile is shown below.  
Other soldering methods are not recommended as they might cause damage to the product.

Reflow Soldering Profile For Lead-free SMT Process.



NOTES:

1. We recommend the reflow temperature 245°C(+/-5°C). The maximum soldering temperature should be limited to 260°C.
2. Don't cause stress to the epoxy resin while it is exposed to high temperature.
3. Number of reflow process shall be 2 times or less.

### Recommended Soldering Pattern (Units : mm; Tolerance: ± 0.1)

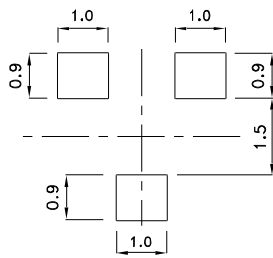

### Reel Dimension



### Tape Dimensions (Units : mm)

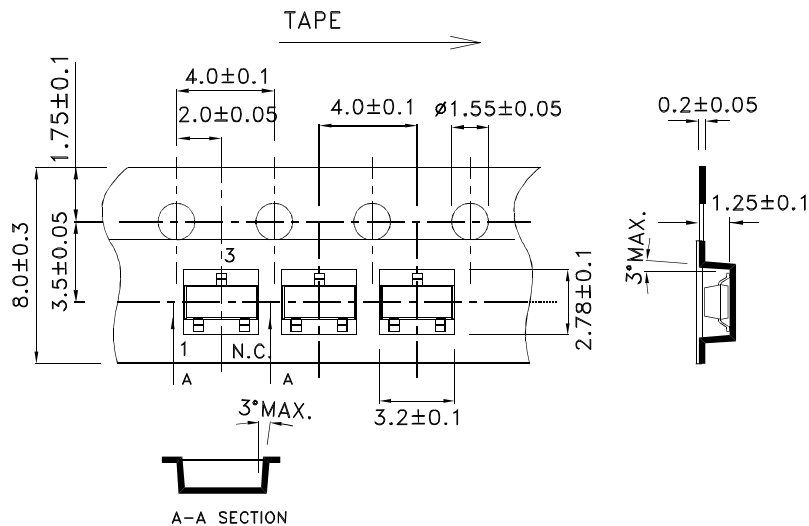

# Kingbright

## PACKING & LABEL SPECIFICATIONS

## AM23ID-F

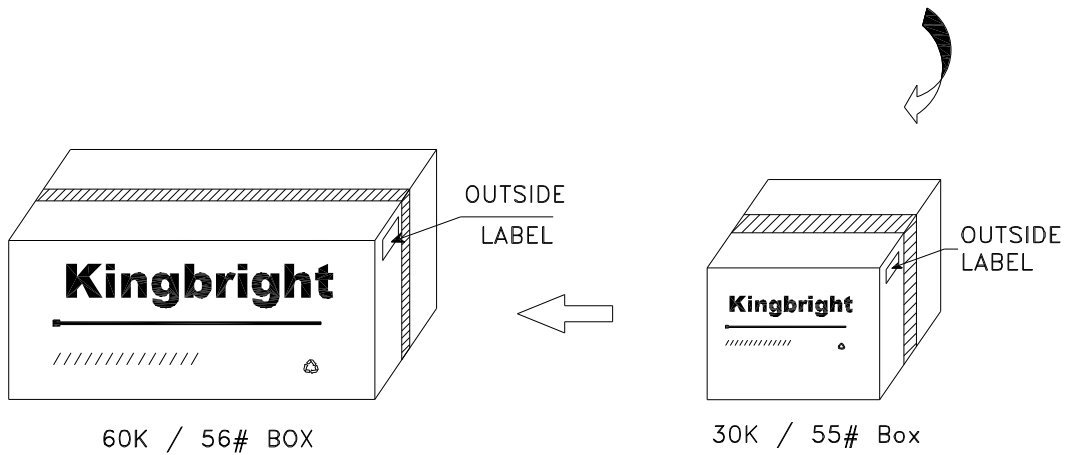
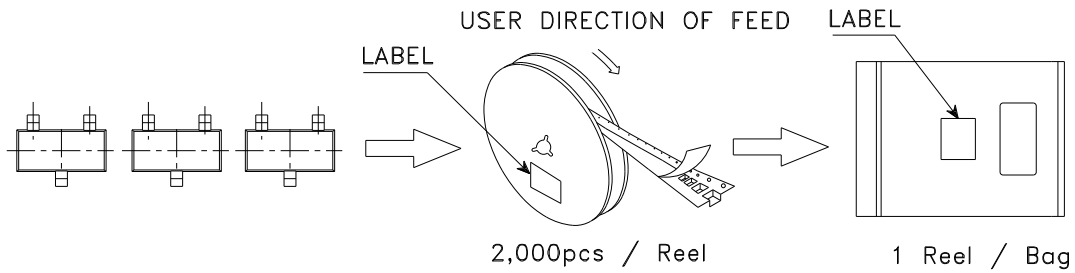

<h1>Kingbright</h1>	
P/NO: AM23xxx	
QTY: 2,000 pcs	Q.C. <span style="border: 1px solid black; border-radius: 50%; padding: 2px;">Q C xx xx xxxx PASSED</span>
S/N: XXXX	
CODE: XXX	
LOT NO:	
 xxxxxxxxxxxxxxxxxxxxxxxxxxxx	
RoHS Compliant	

## Данный компонент на территории Российской Федерации

### Вы можете приобрести в компании MosChip.

Для оперативного оформления запроса Вам необходимо перейти по данной ссылке:

<http://moschip.ru/get-element>

Вы можете разместить у нас заказ для любого Вашего проекта, будь то серийное производство или разработка единичного прибора.

В нашем ассортименте представлены ведущие мировые производители активных и пассивных электронных компонентов.

Нашей специализацией является поставка электронной компонентной базы двойного назначения, продукции таких производителей как XILINX, Intel (ex.ALTERA), Vicor, Microchip, Texas Instruments, Analog Devices, Mini-Circuits, Amphenol, Glenair.

Сотрудничество с глобальными дистрибьюторами электронных компонентов, предоставляет возможность заказывать и получать с международных складов практически любой перечень компонентов в оптимальные для Вас сроки.

На всех этапах разработки и производства наши партнеры могут получить квалифицированную поддержку опытных инженеров.

Система менеджмента качества компании отвечает требованиям в соответствии с ГОСТ Р ИСО 9001, ГОСТ РВ 0015-002 и ЭС РД 009

### Офис по работе с юридическими лицами:

105318, г.Москва, ул.Щербаковская д.3, офис 1107, 1118, ДЦ «Щербаковский»

Телефон: +7 495 668-12-70 (многоканальный)

Факс: +7 495 668-12-70 (доб.304)

E-mail: [info@moschip.ru](mailto:info@moschip.ru)

Skype отдела продаж:

moschip.ru

moschip.ru\_4

moschip.ru\_6

moschip.ru\_9