

LT Product Profile

00424

**LEADER
TECH** 
a HEICO company
The Leading Edge in EMI Shielding Technology



Board Shield Prototype Kit

If you are looking for a faster, easier and less expensive way to create a custom prototype of a high-performance Leader Tech circuit board shield, you need to get your hands on our newest Board Shield Prototype Kit or BSP. This ultimate do-it-yourself kit contains everything that you need to quickly create and assemble a one or two piece, production-quality circuit board shield without requiring special tools or experience.

We provide you with everything you will need to create your prototype shield. The BSP Kit includes a large selection of Leader Tech CBS fences, Tech Clips and SMS covers as well as customizable cover materials that you can cut and form to fit the exact shape and size of your board component. The instruction sheet even features assembly photos and step-by-step directions on how to make the perfect prototype board shield in just minutes.

Tech Clips

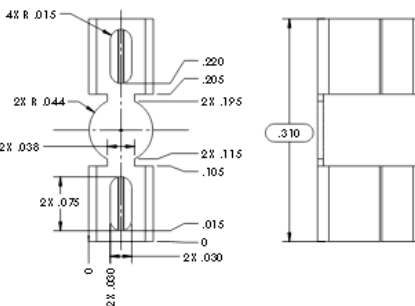
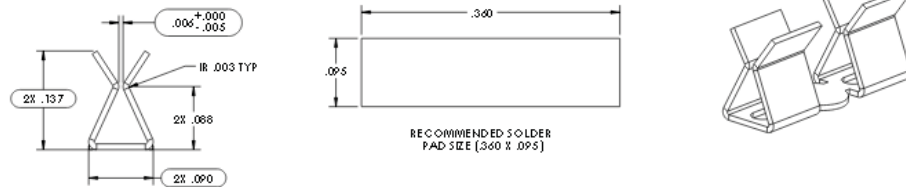

Standard Cover

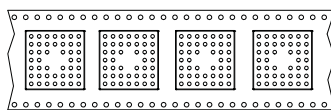

CARRIER TAPE

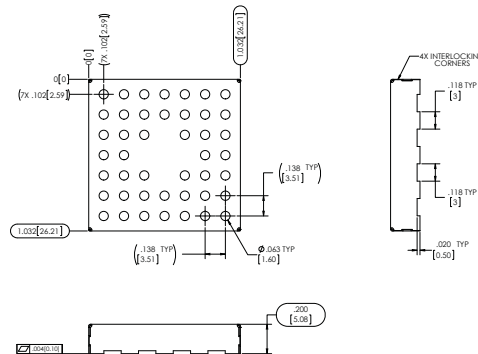

Included in Your Kit

- 1 - 12" x .130" 10-CBS Series Fence
- 1 - 12" x .200" 20-CBS Series Fence
- 1 - 12" x .400" 40-CBS Series Fence
- 1 - 12" x .500" 50-CBS Series Fence
- 1 - 12" x .800" 80-CBS Series Fence
- 20 - Tech Clips in standard tape and reel packaging
- 1 - 5" x 5" x .008" Tech Clip Cover
- 1 - 5" x 5" x .010" Tech Clip Cover
- 1 - 5" x 5" x .015" Tech Clip Cover
- 1 - 1.032" x 1.032" x .200" Standard Cover
- 1 - 6" Stainless Steel Ruler
- 1 - 1" x 12" Conductive Copper Foil Tape

Applications & Benefits

- Everything you need to assemble a high performance PCB shield prototype without special tools or experience.
- Fast and easy solution to streamline development and EMI test stages of your project saving you time and money.

Available Through Distribution



**BOARD SHIELD
PROTOTYPE KIT**

A passion in all we do
www.LeaderTechInc.com

ISO 9001: 2008
CERTIFIED

 RoHS
COMPLIANT

**LEADER
TECH** 
a HEICO company

Global EMI Shielding Technology Center
12420 Race Track Rd., Tampa, Florida 33626
866.TECH.EMI (866.832.4364) † 813.855.6921 ‡ 813.855.3291

STATEMENT OF LIEU OF WARRANTY: All technical information and data in this document is based on tests and is believed to be accurate and reliable. Nevertheless, since the products described herein are not provided to conform with mutually accepted specifications and the use thereof is unknown, the manufacturer and seller of the products do not guarantee results, freedom from patent infringement, or suitability of the products for any application thereof. The manufacturer and seller of the products described in this document will provide all possible technical assistance and will replace any products proven defective. No statement or recommendations made by the manufacturer or seller not contained herein shall have any force of effect unless in conformity with an agreement signed by an officer of the seller and manufacturer. Product testing by the purchaser is recommended in order to confirm expected results.

10 Series

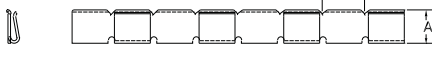

20 Series

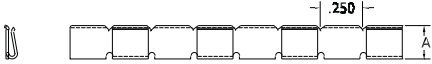

40 Series

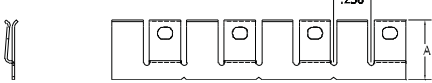

50 Series

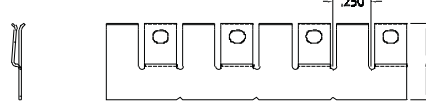

80 Series

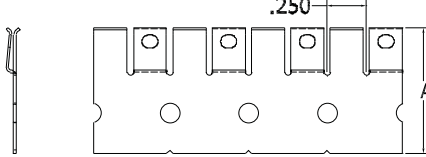

Tech Clip Cover .008"

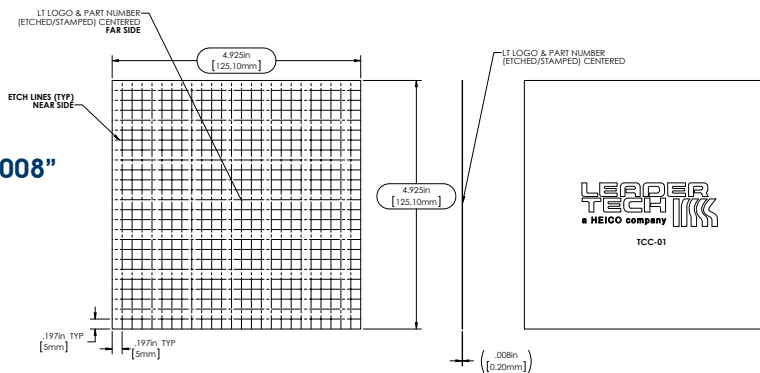

Tech Clip Cover .010"

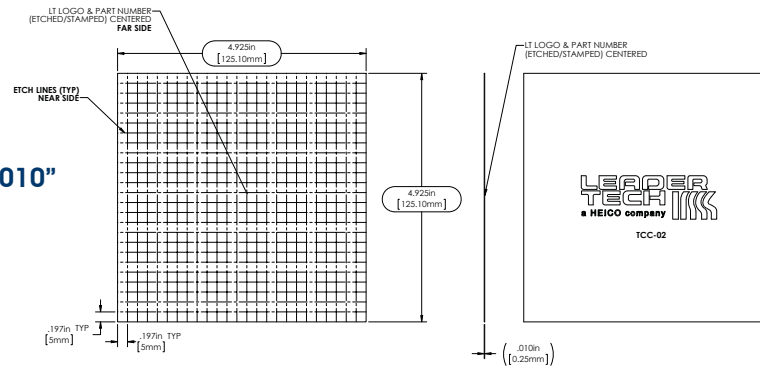

Tech Clip Cover .015"

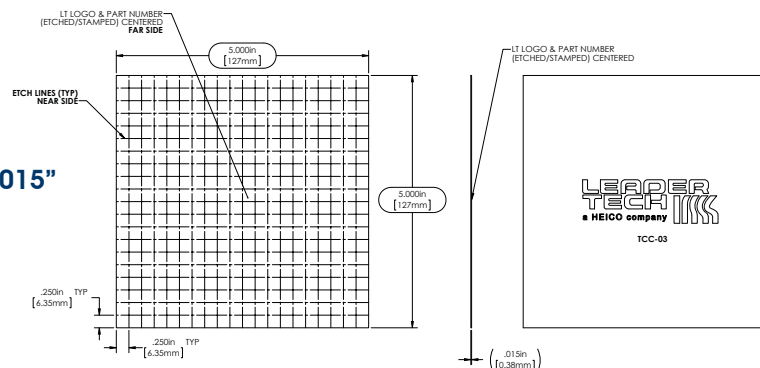

Global EMI Shielding Technology Center
12420 Race Track Rd., Tampa, Florida 33626
866.TECH.EMI (866.832.4364) † 813.855.6921 ‡ 813.855.3291

STATEMENT OF LIEU OF WARRANTY: All technical information and data in this document is based on tests and is believed to be accurate and reliable. Nevertheless, since the products described herein are not provided to conform with mutually accepted specifications and the use thereof is unknown, the manufacturer and seller of the products do not guarantee results, freedom from patent infringement, or suitability of the products for any application thereof. The manufacturer and seller of the products described in this document will provide all possible technical assistance and will replace any products proven defective. No statement or recommendations made by the manufacturer or seller not contained herein shall have any force of effect unless in conformity with an agreement signed by an officer of the seller and manufacturer. Product testing by the purchaser is recommended in order to confirm expected results.

Material

- Tech Clips - .008" Thick Pre-Tin Plated Phos. Bronze
- Tech Clip Covers - .008", .010", or .015" Thick Alloy 770
- CBS Series Fences - .015" Thick Pre-Tin Plated Steel
- Standard Cover - .008" Thick Pre-Tin Plated Steel
- Conductive Copper Foil Tape - 0.003" Thick Copper Foil Pressure Sensitive Adhesive

Assembly Directions



Availability

- In stock and ready to ship
- Full production quantities of your completed Tech Clip Cover can be made available in as little as 2 weeks.



**BOARD SHIELD
PROTOTYPE KIT**

A passion in all we do
www.LeaderTechInc.com



Данный компонент на территории Российской Федерации

Вы можете приобрести в компании MosChip.

Для оперативного оформления запроса Вам необходимо перейти по данной ссылке:

<http://moschip.ru/get-element>

Вы можете разместить у нас заказ для любого Вашего проекта, будь то серийное производство или разработка единичного прибора.

В нашем ассортименте представлены ведущие мировые производители активных и пассивных электронных компонентов.

Нашей специализацией является поставка электронной компонентной базы двойного назначения, продукции таких производителей как XILINX, Intel (ex.ALTERA), Vicor, Microchip, Texas Instruments, Analog Devices, Mini-Circuits, Amphenol, Glenair.

Сотрудничество с глобальными дистрибьюторами электронных компонентов, предоставляет возможность заказывать и получать с международных складов практически любой перечень компонентов в оптимальные для Вас сроки.

На всех этапах разработки и производства наши партнеры могут получить квалифицированную поддержку опытных инженеров.

Система менеджмента качества компании отвечает требованиям в соответствии с ГОСТ Р ИСО 9001, ГОСТ РВ 0015-002 и ЭС РД 009

Офис по работе с юридическими лицами:

105318, г.Москва, ул.Щербаковская д.3, офис 1107, 1118, ДЦ «Щербаковский»

Телефон: +7 495 668-12-70 (многоканальный)

Факс: +7 495 668-12-70 (доб.304)

E-mail: info@moschip.ru

Skype отдела продаж:

moschip.ru

moschip.ru_4

moschip.ru_6

moschip.ru_9