

## ADSP-BF522/ADSP-BF523/ADSP-BF524/ADSP-BF525/ADSP-BF526/ADSP-BF527

### FEATURES

- Up to 600 MHz high performance Blackfin processor
- Two 16-bit MACs, two 40-bit ALUs, four 8-bit video ALUs, 40-bit shifter
- RISC-like register and instruction model for ease of programming and compiler-friendly support
- Advanced debug, trace, and performance monitoring
- Accepts a wide range of supply voltages for internal and I/O operations. See [Specifications on Page 27](#)
- Programmable on-chip voltage regulator (ADSP-BF523/ADSP-BF525/ADSP-BF527 processors only)
- Qualified for Automotive Applications. See [Automotive Products on Page 86](#)
- 289-ball and 208-ball CSP\_BGA packages

### MEMORY

- 132K bytes of on-chip memory (See [Table 1 on Page 3](#) for L1 and L3 memory size details)
- External memory controller with glueless support for SDRAM and asynchronous 8-bit and 16-bit memories
- Flexible booting options from external flash, SPI, and TWI memory or from host devices including SPI, TWI, and UART
- Code security with Lockbox Secure Technology
- one-time-programmable (OTP) memory
- Memory management unit providing memory protection

### PERIPHERALS

- USB 2.0 high speed on-the-go (OTG) with integrated PHY
- IEEE 802.3-compliant 10/100 Ethernet MAC
- Parallel peripheral interface (PPI), supporting ITU-R 656 video data formats
- Host DMA port (HOSTDP)
- 2 dual-channel, full-duplex synchronous serial ports (SPORTs), supporting eight stereo I<sup>2</sup>S channels
- 12 peripheral DMAs, 2 mastered by the Ethernet MAC
- 2 memory-to-memory DMAs with external request lines
- Event handler with 54 interrupt inputs
- Serial peripheral interface (SPI) compatible port
- 2 UARTs with IrDA support
- 2-wire interface (TWI) controller
- Eight 32-bit timers/counters with PWM support
- 32-bit up/down counter with rotary support
- Real-time clock (RTC) and watchdog timer
- 32-bit core timer
- 48 general-purpose I/Os (GPIOs), with programmable hysteresis
- NAND flash controller (NFC)
- Debug/JTAG interface
- On-chip PLL capable of frequency multiplication



Figure 1. Processor Block Diagram

Blackfin and the Blackfin logo are registered trademarks of Analog Devices, Inc.

### Rev. C

Information furnished by Analog Devices is believed to be accurate and reliable. However, no responsibility is assumed by Analog Devices for its use, nor for any infringements of patents or other rights of third parties that may result from its use. Specifications subject to change without notice. No license is granted by implication or otherwise under any patent or patent rights of Analog Devices. Trademarks and registered trademarks are the property of their respective owners.

# ADSP-BF522/ADSP-BF523/ADSP-BF524/ADSP-BF525/ADSP-BF526/ADSP-BF527

## TABLE OF CONTENTS

Features .....	1	Booting Modes .....	18
Memory .....	1	Instruction Set Description .....	20
Peripherals .....	1	Development Tools .....	21
General Description .....	3	Designing an Emulator-Compatible Processor Board (Target) .....	21
Portable Low Power Architecture .....	3	Related Documents .....	21
System Integration .....	3	Related Signal Chains .....	21
Processor Peripherals .....	3	Lockbox Secure Technology Disclaimer .....	21
Blackfin Processor Core .....	4	Signal Descriptions .....	22
Memory Architecture .....	5	Specifications .....	27
DMA Controllers .....	9	Operating Conditions for ADSP-BF522/ADSP-BF524/ADSP-BF526 Processors .....	27
Host DMA Port .....	9	Operating Conditions for ADSP-BF523/ADSP-BF525/ADSP-BF527 Processors .....	29
Real-Time Clock .....	10	Electrical Characteristics .....	31
Watchdog Timer .....	10	Absolute Maximum Ratings .....	36
Timers .....	10	Package Information .....	37
Up/Down Counter and Thumbwheel Interface .....	10	ESD Sensitivity .....	37
Serial Ports .....	11	Timing Specifications .....	38
Serial Peripheral Interface (SPI) Port .....	11	Output Drive Currents .....	72
UART Ports .....	11	Test Conditions .....	74
TWI Controller Interface .....	12	Environmental Conditions .....	78
10/100 Ethernet MAC .....	12	289-Ball CSP_BGA Ball Assignment .....	79
Ports .....	12	208-Ball CSP_BGA Ball Assignment .....	82
Parallel Peripheral Interface (PPI) .....	13	Outline Dimensions .....	85
USB On-The-Go Dual-Role Device Controller .....	14	Surface-Mount Design .....	86
Code Security with Lockbox Secure Technology .....	14	Automotive Products .....	86
Dynamic Power Management .....	14	Ordering Guide .....	87
ADSP-BF523/ADSP-BF525/ADSP-BF527 Voltage Regulation .....	16		
ADSP-BF522/ADSP-BF524/ADSP-BF526 Voltage Regulation .....	16		
Clock Signals .....	16		

## REVISION HISTORY

### 3/12—Rev. B to Rev. C

Corrected USB_VREF and USB_VBUS function (DOC ID: DOC-881) descriptions in <a href="#">Signal Descriptions</a> .....	22	Replaced 289-Ball CSP_BGA (BC-289-2) .....	85
Corrected footnote on $V_{DDMEM}$ , <a href="#">Operating Conditions for ADSP-BF523/ADSP-BF525/ADSP-BF527 Processors</a> .....	29	Added the ADBF525WYBCZxxx model to <a href="#">Automotive Products</a> .....	86
Corrected footnotes and added parameters (DOC-ID: DOC-901) in <a href="#">Table 26, Absolute Maximum Ratings</a> .....	36	Added the ADSP-BF525ABCZ-5 and ADSP-BF525ABCZ-6 models to <a href="#">Ordering Guide</a> .....	87
Corrected footnote on <a href="#">Table 27, Maximum Duty Cycle for Input Transient Voltage</a> , .....	36		
Added <a href="#">Table 29, Maximum Duty Cycle for IOH/IOL Current Per Pin Group</a> .....	37		

## GENERAL DESCRIPTION

The ADSP-BF52x processors are members of the Blackfin family of products, incorporating the Analog Devices/Intel Micro Signal Architecture (MSA). Blackfin® processors combine a dual-MAC state-of-the-art signal processing engine, the advantages of a clean, orthogonal RISC-like microprocessor instruction set, and single-instruction, multiple-data (SIMD) multimedia capabilities into a single instruction-set architecture.

The ADSP-BF52x processors are completely code compatible with other Blackfin processors. The ADSP-BF523/ADSP-BF525/ADSP-BF527 processors offer performance up to 600 MHz. The ADSP-BF522/ADSP-BF524/ADSP-BF526 processors offer performance up to 400 MHz and reduced static power consumption. Differences with respect to peripheral combinations are shown in [Table 1](#).

**Table 1. Processor Comparison**

Feature	ADSP-BF522	ADSP-BF524	ADSP-BF526	ADSP-BF523	ADSP-BF525	ADSP-BF527
Host DMA	1	1	1	1	1	1
USB	-	1	1	-	1	1
Ethernet MAC	-	-	1	-	-	1
Internal Voltage Regulator	-	-	-	1	1	1
TWI	1	1	1	1	1	1
SPORTs	2	2	2	2	2	2
UARTs	2	2	2	2	2	2
SPI	1	1	1	1	1	1
GP Timers	8	8	8	8	8	8
GP Counter	1	1	1	1	1	1
Watchdog Timers	1	1	1	1	1	1
RTC	1	1	1	1	1	1
Parallel Peripheral Interface	1	1	1	1	1	1
GPIOs	48	48	48	48	48	48
Memory (bytes)						
L1 Instruction SRAM	48K	48K	48K	48K	48K	48K
L1 Instruction SRAM/Cache	16K	16K	16K	16K	16K	16K
L1 Data SRAM	32K	32K	32K	32K	32K	32K
L1 Data SRAM/Cache	32K	32K	32K	32K	32K	32K
L1 Scratchpad	4K	4K	4K	4K	4K	4K
L3 Boot ROM	32K	32K	32K	32K	32K	32K
Maximum Instruction Rate <sup>1</sup>	400 MHz			600 MHz		
Maximum System Clock Speed	100 MHz			133 MHz		
Package Options	289-Ball CSP_BGA 208-Ball CSP_BGA					

<sup>1</sup> Maximum instruction rate is not available with every possible SCLK selection.

By integrating a rich set of industry-leading system peripherals and memory, Blackfin processors are the platform of choice for next-generation applications that require RISC-like programmability, multimedia support, and leading-edge signal processing in one integrated package.

## PORTABLE LOW POWER ARCHITECTURE

Blackfin processors provide world-class power management and performance. They are produced with a low power and low voltage design methodology and feature on-chip dynamic power management, which is the ability to vary both the voltage and frequency of operation to significantly lower overall power consumption. This capability can result in a substantial reduction in power consumption, compared with just varying the frequency of operation. This allows longer battery life for portable appliances.

## SYSTEM INTEGRATION

The ADSP-BF52x processors are highly integrated system-on-a-chip solutions for the next generation of embedded network connected applications. By combining industry-standard interfaces with a high performance signal processing core, cost-effective applications can be developed quickly, without the need for costly external components. The system peripherals include an IEEE-compliant 802.3 10/100 Ethernet MAC, a USB 2.0 high speed OTG controller, a TWI controller, a NAND flash controller, two UART ports, an SPI port, two serial ports (SPORTs), eight general purpose 32-bit timers with PWM capability, a core timer, a real-time clock, a watchdog timer, a Host DMA (HOSTDP) interface, and a parallel peripheral interface (PPI).

## PROCESSOR PERIPHERALS

The ADSP-BF52x processors contain a rich set of peripherals connected to the core via several high bandwidth buses, providing flexibility in system configuration as well as excellent overall system performance (see the block diagram on [Page 1](#)).

These Blackfin processors contain dedicated network communication modules and high speed serial and parallel ports, an interrupt controller for flexible management of interrupts from the on-chip peripherals or external sources, and power management control functions to tailor the performance and power characteristics of the processor and system to many application scenarios.

All of the peripherals, except for the general-purpose I/O, TWI, real-time clock, and timers, are supported by a flexible DMA structure. There are also separate memory DMA channels dedicated to data transfers between the processor's various memory spaces, including external SDRAM and asynchronous memory. Multiple on-chip buses running at up to 133 MHz provide enough bandwidth to keep the processor core running along with activity on all of the on-chip and external peripherals.

The ADSP-BF523/ADSP-BF525/ADSP-BF527 processors include an on-chip voltage regulator in support of the processor's dynamic power management capability. The voltage

# ADSP-BF522/ADSP-BF523/ADSP-BF524/ADSP-BF525/ADSP-BF526/ADSP-BF527

regulator provides a range of core voltage levels when supplied from  $V_{DDEXT}$ . The voltage regulator can be bypassed at the user's discretion.

## BLACKFIN PROCESSOR CORE

As shown in Figure 2, the Blackfin processor core contains two 16-bit multipliers, two 40-bit accumulators, two 40-bit ALUs, four video ALUs, and a 40-bit shifter. The computation units process 8-, 16-, or 32-bit data from the register file.

The compute register file contains eight 32-bit registers. When performing compute operations on 16-bit operand data, the register file operates as 16 independent 16-bit registers. All operands for compute operations come from the multiported register file and instruction constant fields.

Each MAC can perform a 16-bit by 16-bit multiply in each cycle, accumulating the results into the 40-bit accumulators. Signed and unsigned formats, rounding, and saturation are supported.

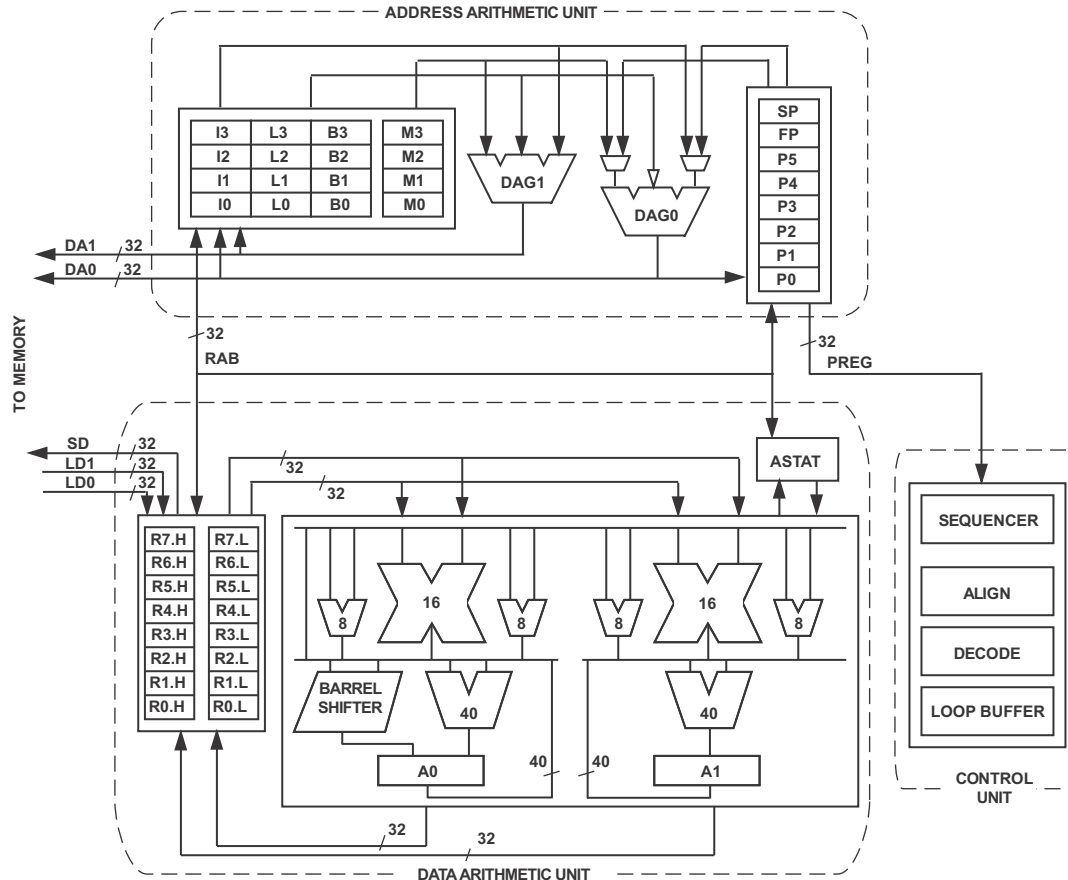

Figure 2. Blackfin Processor Core

The ALUs perform a traditional set of arithmetic and logical operations on 16-bit or 32-bit data. In addition, many special instructions are included to accelerate various signal processing tasks. These include bit operations such as field extract and population count, modulo  $2^{32}$  multiply, divide primitives, saturation and rounding, and sign/exponent detection. The set of video instructions include byte alignment and packing operations, 16-bit and 8-bit adds with clipping, 8-bit average operations, and 8-bit subtract/absolute value/accumulate (SAA) operations. Also provided are the compare/select and vector search instructions.

For certain instructions, two 16-bit ALU operations can be performed simultaneously on register pairs (a 16-bit high half and 16-bit low half of a compute register). If the second ALU is used, quad 16-bit operations are possible.

The 40-bit shifter can perform shifts and rotates and is used to support normalization, field extract, and field deposit instructions.

The program sequencer controls the flow of instruction execution, including instruction alignment and decoding. For program flow control, the sequencer supports PC relative and indirect conditional jumps (with static branch prediction), and subroutine calls. Hardware is provided to support zero-overhead looping. The architecture is fully interlocked, meaning that the programmer need not manage the pipeline when executing instructions with data dependencies.

The address arithmetic unit provides two addresses for simultaneous dual fetches from memory. It contains a multiported register file consisting of four sets of 32-bit index, modify,

length, and base registers (for circular buffering), and eight additional 32-bit pointer registers (for C-style indexed stack manipulation).

Blackfin processors support a modified Harvard architecture in combination with a hierarchical memory structure. Level 1 (L1) memories are those that typically operate at the full processor speed with little or no latency. At the L1 level, the instruction memory holds instructions only. The two data memories hold data, and a dedicated scratchpad data memory stores stack and local variable information.

In addition, multiple L1 memory blocks are provided, offering a configurable mix of SRAM and cache. The memory management unit (MMU) provides memory protection for individual tasks that may be operating on the core and can protect system registers from unintended access.

The architecture provides three modes of operation: user mode, supervisor mode, and emulation mode. User mode has restricted access to certain system resources, thus providing a protected software environment, while supervisor mode has unrestricted access to the system and core resources.

The Blackfin processor instruction set has been optimized so that 16-bit opcodes represent the most frequently used instructions, resulting in excellent compiled code density. Complex DSP instructions are encoded into 32-bit opcodes, representing fully featured multifunction instructions. Blackfin processors support a limited multi-issue capability, where a 32-bit instruction can be issued in parallel with two 16-bit instructions, allowing the programmer to use many of the core resources in a single instruction cycle.

The Blackfin processor assembly language uses an algebraic syntax for ease of coding and readability. The architecture has been optimized for use in conjunction with the C/C++ compiler, resulting in fast and efficient software implementations.

## MEMORY ARCHITECTURE

The Blackfin processor views memory as a single unified 4G byte address space, using 32-bit addresses. All resources, including internal memory, external memory, and I/O control registers, occupy separate sections of this common address space. The memory portions of this address space are arranged in a hierarchical structure to provide a good cost/performance balance of some very fast, low-latency on-chip memory as cache or SRAM, and larger, lower-cost and performance off-chip memory systems. See [Figure 3](#).

The on-chip L1 memory system is the highest-performance memory available to the Blackfin processor. The off-chip memory system, accessed through the external bus interface unit (EBIU), provides expansion with SDRAM, flash memory, and SRAM, optionally accessing up to 132M bytes of physical memory.

The memory DMA controller provides high-bandwidth data-movement capability. It can perform block transfers of code or data between the internal memory and the external memory spaces.

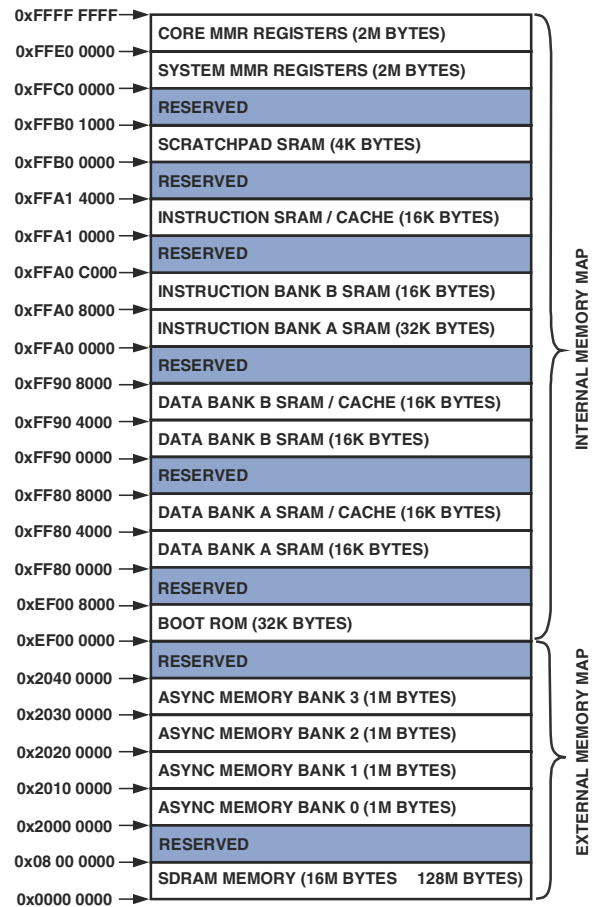

Figure 3. Internal/External Memory Map

### Internal (On-Chip) Memory

The processor has three blocks of on-chip memory providing high-bandwidth access to the core.

The first block is the L1 instruction memory, consisting of 64K bytes SRAM, of which 16K bytes can be configured as a four-way set-associative cache. This memory is accessed at full processor speed.

The second on-chip memory block is the L1 data memory, consisting of up to two banks of up to 32K bytes each. Each memory bank is configurable, offering both cache and SRAM functionality. This memory block is accessed at full processor speed.

The third memory block is a 4K byte scratchpad SRAM which runs at the same speed as the L1 memories, but is only accessible as data SRAM and cannot be configured as cache memory.

### External (Off-Chip) Memory

External memory is accessed via the EBIU. This 16-bit interface provides a glueless connection to a bank of synchronous DRAM (SDRAM), as well as up to four banks of asynchronous memory devices including flash, EPROM, ROM, SRAM, and memory mapped I/O devices.

The SDRAM controller can be programmed to interface to up to 128M bytes of SDRAM. A separate row can be open for each SDRAM internal bank and the SDRAM controller supports up to 4 internal SDRAM banks, improving overall performance.

The asynchronous memory controller can be programmed to control up to four banks of devices with very flexible timing requirements for a wide variety of devices. Each bank occupies a 1M byte segment regardless of the size of the devices used, so that these banks are only contiguous if each is fully populated with 1M byte of memory.

## **NAND Flash Controller (NFC)**

The ADSP-BF52x processors provide a NAND flash controller (NFC). NAND flash devices provide high-density, low-cost memory. However, NAND flash devices also have long random access times, invalid blocks, and lower reliability over device lifetimes. Because of this, NAND flash is often used for read-only code storage. In this case, all DSP code can be stored in NAND flash and then transferred to a faster memory (such as SDRAM or SRAM) before execution. Another common use of NAND flash is for storage of multimedia files or other large data segments. In this case, a software file system may be used to manage reading and writing of the NAND flash device. The file system selects memory segments for storage with the goal of avoiding bad blocks and equally distributing memory accesses across all address locations. Hardware features of the NFC include:

- Support for page program, page read, and block erase of NAND flash devices, with accesses aligned to page boundaries.
- Error checking and correction (ECC) hardware that facilitates error detection and correction.
- A single 8-bit external bus interface for commands, addresses, and data.
- Support for SLC (single level cell) NAND flash devices unlimited in size, with page sizes of 256 and 512 bytes. Larger page sizes can be supported in software.
- Capability of releasing external bus interface pins during long accesses.
- Support for internal bus requests of 16 bits.
- DMA engine to transfer data between internal memory and NAND flash device.

## **One-Time Programmable Memory**

The processor has 64K bits of one-time programmable non-volatile memory that can be programmed by the developer only one time. It includes the array and logic to support read access and programming. Additionally, its pages can be write protected.

OTP enables developers to store both public and private data on-chip. In addition to storing public and private key data for applications requiring security, it also allows developers to store completely user-definable data such as customer ID, product

ID, MAC address, etc. Hence, generic parts can be shipped, which are then programmed and protected by the developer within this non-volatile memory.

## **I/O Memory Space**

The processor does not define a separate I/O space. All resources are mapped through the flat 32-bit address space. On-chip I/O devices have their control registers mapped into memory-mapped registers (MMRs) at addresses near the top of the 4G byte address space. These are separated into two smaller blocks, one which contains the control MMRs for all core functions, and the other which contains the registers needed for setup and control of the on-chip peripherals outside of the core. The MMRs are accessible only in supervisor mode and appear as reserved space to on-chip peripherals.

## **Booting**

The processor contains a small on-chip boot kernel, which configures the appropriate peripheral for booting. If the processor is configured to boot from boot ROM memory space, the processor starts executing from the on-chip boot ROM. For more information, see [Booting Modes on Page 18](#).

## **Event Handling**

The event controller on the processor handles all asynchronous and synchronous events to the processor. The processor provides event handling that supports both nesting and prioritization. Nesting allows multiple event service routines to be active simultaneously. Prioritization ensures that servicing of a higher-priority event takes precedence over servicing of a lower-priority event. The controller provides support for five different types of events:

- Emulation — An emulation event causes the processor to enter emulation mode, allowing command and control of the processor via the JTAG interface.
- $\overline{\text{RESET}}$  — This event resets the processor.
- Nonmaskable Interrupt (NMI) — The NMI event can be generated by the software watchdog timer or by the  $\overline{\text{NMI}}$  input signal to the processor. The NMI event is frequently used as a power-down indicator to initiate an orderly shut-down of the system.
- Exceptions — Events that occur synchronously to program flow (in other words, the exception is taken before the instruction is allowed to complete). Conditions such as data alignment violations and undefined instructions cause exceptions.
- Interrupts — Events that occur asynchronously to program flow. They are caused by input signals, timers, and other peripherals, as well as by an explicit software instruction.

Each event type has an associated register to hold the return address and an associated return-from-event instruction. When an event is triggered, the state of the processor is saved on the supervisor stack.

The processor event controller consists of two stages, the core event controller (CEC) and the system interrupt controller (SIC). The core event controller works with the system interrupt

# ADSP-BF522/ADSP-BF523/ADSP-BF524/ADSP-BF525/ADSP-BF526/ADSP-BF527

controller to prioritize and control all system events. Conceptually, interrupts from the peripherals enter into the SIC and are then routed directly into the general-purpose interrupts of the CEC.

### Core Event Controller (CEC)

The CEC supports nine general-purpose interrupts (IVG15–7), in addition to the dedicated interrupt and exception events. Of these general-purpose interrupts, the two lowest-priority interrupts (IVG15–14) are recommended to be reserved for software interrupt handlers, leaving seven prioritized interrupt inputs to support the peripherals of the processor. [Table 2](#) describes the inputs to the CEC, identifies their names in the event vector table (EVT), and lists their priorities.

### System Interrupt Controller (SIC)

The system interrupt controller provides the mapping and routing of events from the many peripheral interrupt sources to the prioritized general-purpose interrupt inputs of the CEC. Although the processor provides a default mapping, the user can alter the mappings and priorities of interrupt events by writing the appropriate values into the interrupt assignment registers (SIC\_IARx). [Table 3](#) describes the inputs into the SIC and the default mappings into the CEC.

**Table 2. Core Event Controller (CEC)**

Priority (0 is Highest)	Event Class	EVT Entry
0	Emulation/Test Control	EMU
1	$\overline{\text{RESET}}$	RST
2	Nonmaskable Interrupt	$\overline{\text{NMI}}$
3	Exception	EVX
4	Reserved	—
5	Hardware Error	IVHW
6	Core Timer	IVTMR
7	General-Purpose Interrupt 7	IVG7
8	General-Purpose Interrupt 8	IVG8
9	General-Purpose Interrupt 9	IVG9
10	General-Purpose Interrupt 10	IVG10
11	General-Purpose Interrupt 11	IVG11
12	General-Purpose Interrupt 12	IVG12
13	General-Purpose Interrupt 13	IVG13
14	General-Purpose Interrupt 14	IVG14
15	General-Purpose Interrupt 15	IVG15

**Table 3. System Interrupt Controller (SIC)**

Peripheral Interrupt Event	General Purpose Interrupt (at $\overline{\text{RESET}}$ )	Peripheral Interrupt ID	Default Core Interrupt ID	SIC Registers	
PLL Wakeup Interrupt	IVG7	0	0	IAR0	IMASK0, ISR0, IWRO
DMA Error 0 (generic)	IVG7	1	0	IAR0	IMASK0, ISR0, IWRO
DMAR0 Block Interrupt	IVG7	2	0	IAR0	IMASK0, ISR0, IWRO
DMAR1 Block Interrupt	IVG7	3	0	IAR0	IMASK0, ISR0, IWRO
DMAR0 Overflow Error	IVG7	4	0	IAR0	IMASK0, ISR0, IWRO
DMAR1 Overflow Error	IVG7	5	0	IAR0	IMASK0, ISR0, IWRO
PPI Error	IVG7	6	0	IAR0	IMASK0, ISR0, IWRO
MAC Status	IVG7	7	0	IAR0	IMASK0, ISR0, IWRO
SPORT0 Status	IVG7	8	0	IAR1	IMASK0, ISR0, IWRO
SPORT1 Status	IVG7	9	0	IAR1	IMASK0, ISR0, IWRO
Reserved	IVG7	10	0	IAR1	IMASK0, ISR0, IWRO
Reserved	IVG7	11	0	IAR1	IMASK0, ISR0, IWRO
UART0 Status	IVG7	12	0	IAR1	IMASK0, ISR0, IWRO
UART1 Status	IVG7	13	0	IAR1	IMASK0, ISR0, IWRO
RTC	IVG8	14	1	IAR1	IMASK0, ISR0, IWRO
DMA Channel 0 (PPI/NFC)	IVG8	15	1	IAR1	IMASK0, ISR0, IWRO
DMA Channel 3 (SPORT0 RX)	IVG9	16	2	IAR2	IMASK0, ISR0, IWRO
DMA Channel 4 (SPORT0 TX)	IVG9	17	2	IAR2	IMASK0, ISR0, IWRO
DMA Channel 5 (SPORT1 RX)	IVG9	18	2	IAR2	IMASK0, ISR0, IWRO
DMA Channel 6 (SPORT1 TX)	IVG9	19	2	IAR2	IMASK0, ISR0, IWRO
TWI	IVG10	20	3	IAR2	IMASK0, ISR0, IWRO
DMA Channel 7 (SPI)	IVG10	21	3	IAR2	IMASK0, ISR0, IWRO
DMA Channel 8 (UART0 RX)	IVG10	22	3	IAR2	IMASK0, ISR0, IWRO
DMA Channel 9 (UART0 TX)	IVG10	23	3	IAR2	IMASK0, ISR0, IWRO
DMA Channel 10 (UART1 RX)	IVG10	24	3	IAR3	IMASK0, ISR0, IWRO
DMA Channel 11 (UART1 TX)	IVG10	25	3	IAR3	IMASK0, ISR0, IWRO

# ADSP-BF522/ADSP-BF523/ADSP-BF524/ADSP-BF525/ADSP-BF526/ADSP-BF527

**Table 3. System Interrupt Controller (SIC) (Continued)**

Peripheral Interrupt Event	General Purpose Interrupt (at RESET)	Peripheral Interrupt ID	Default Core Interrupt ID	SIC Registers	
OTP Memory Interrupt	IVG11	26	4	IAR3	IMASK0, ISR0, IWR0
GP Counter	IVG11	27	4	IAR3	IMASK0, ISR0, IWR0
DMA Channel 1 (MAC RX/HOSTDP)	IVG11	28	4	IAR3	IMASK0, ISR0, IWR0
Port H Interrupt A	IVG11	29	4	IAR3	IMASK0, ISR0, IWR0
DMA Channel 2 (MAC TX/NFC)	IVG11	30	4	IAR3	IMASK0, ISR0, IWR0
Port H Interrupt B	IVG11	31	4	IAR3	IMASK0, ISR0, IWR0
Timer 0	IVG12	32	5	IAR4	IMASK1, ISR1, IWR1
Timer 1	IVG12	33	5	IAR4	IMASK1, ISR1, IWR1
Timer 2	IVG12	34	5	IAR4	IMASK1, ISR1, IWR1
Timer 3	IVG12	35	5	IAR4	IMASK1, ISR1, IWR1
Timer 4	IVG12	36	5	IAR4	IMASK1, ISR1, IWR1
Timer 5	IVG12	37	5	IAR4	IMASK1, ISR1, IWR1
Timer 6	IVG12	38	5	IAR4	IMASK1, ISR1, IWR1
Timer 7	IVG12	39	5	IAR4	IMASK1, ISR1, IWR1
Port G Interrupt A	IVG12	40	5	IAR5	IMASK1, ISR1, IWR1
Port G Interrupt B	IVG12	41	5	IAR5	IMASK1, ISR1, IWR1
MDMA Stream 0	IVG13	42	6	IAR5	IMASK1, ISR1, IWR1
MDMA Stream 1	IVG13	43	6	IAR5	IMASK1, ISR1, IWR1
Software Watchdog Timer	IVG13	44	6	IAR5	IMASK1, ISR1, IWR1
Port F Interrupt A	IVG13	45	6	IAR5	IMASK1, ISR1, IWR1
Port F Interrupt B	IVG13	46	6	IAR5	IMASK1, ISR1, IWR1
SPI Status	IVG7	47	0	IAR5	IMASK1, ISR1, IWR1
NFC Status	IVG7	48	0	IAR6	IMASK1, ISR1, IWR1
HOSTDP Status	IVG7	49	0	IAR6	IMASK1, ISR1, IWR1
Host Read Done	IVG7	50	0	IAR6	IMASK1, ISR1, IWR1
Reserved	IVG10	51	3	IAR6	IMASK1, ISR1, IWR1
USB_INT0 Interrupt	IVG10	52	3	IAR6	IMASK1, ISR1, IWR1
USB_INT1 Interrupt	IVG10	53	3	IAR6	IMASK1, ISR1, IWR1
USB_INT2 Interrupt	IVG10	54	3	IAR6	IMASK1, ISR1, IWR1
USB_DMAINT Interrupt	IVG10	55	3	IAR6	IMASK1, ISR1, IWR1

## Event Control

The processor provides a very flexible mechanism to control the processing of events. In the CEC, three registers are used to coordinate and control events. Each register is 16 bits wide.

- CEC interrupt latch register (ILAT) — Indicates when events have been latched. The appropriate bit is set when the processor has latched the event and cleared when the event has been accepted into the system. This register is updated automatically by the controller, but it may be written only when its corresponding IMASK bit is cleared.
- CEC interrupt mask register (IMASK) — Controls the masking and unmasking of individual events. When a bit is set in the IMASK register, that event is unmasked and is processed by the CEC when asserted. A cleared bit in the IMASK register masks the event, preventing the processor from servicing the event even though the event may be latched in the ILAT register. This register may be read or

written while in supervisor mode. (Note that general-purpose interrupts can be globally enabled and disabled with the STI and CLI instructions, respectively.)

- CEC interrupt pending register (IPEND) — The IPEND register keeps track of all nested events. A set bit in the IPEND register indicates the event is currently active or nested at some level. This register is updated automatically by the controller but may be read while in supervisor mode.

The SIC allows further control of event processing by providing three pairs of 32-bit interrupt control and status registers. Each register contains a bit corresponding to each of the peripheral interrupt events shown in [Table 3 on Page 7](#).

- SIC interrupt mask registers (SIC\_IMASKx) — Control the masking and unmasking of each peripheral interrupt event. When a bit is set in these registers, that peripheral event is



unmasked and is processed by the system when asserted. A cleared bit in the register masks the peripheral event, preventing the processor from servicing the event.

- SIC interrupt status registers (SIC\_ISRx) — As multiple peripherals can be mapped to a single event, these registers allow the software to determine which peripheral event source triggered the interrupt. A set bit indicates the peripheral is asserting the interrupt, and a cleared bit indicates the peripheral is not asserting the event.
- SIC interrupt wakeup enable registers (SIC\_IWRx) — By enabling the corresponding bit in these registers, a peripheral can be configured to wake up the processor, should the core be idled or in sleep mode when the event is generated. For more information see [Dynamic Power Management on Page 14](#).

Because multiple interrupt sources can map to a single general-purpose interrupt, multiple pulse assertions can occur simultaneously, before or during interrupt processing for an interrupt event already detected on this interrupt input. The IPEND register contents are monitored by the SIC as the interrupt acknowledgement.

The appropriate ILAT register bit is set when an interrupt rising edge is detected (detection requires two core clock cycles). The bit is cleared when the respective IPEND register bit is set. The IPEND bit indicates that the event has entered into the processor pipeline. At this point the CEC recognizes and queues the next rising edge event on the corresponding event input. The minimum latency from the rising edge transition of the general-purpose interrupt to the IPEND output asserted is three core clock cycles; however, the latency can be much higher, depending on the activity within and the state of the processor.

## DMA CONTROLLERS

The processor has multiple, independent DMA channels that support automated data transfers with minimal overhead for the processor core. DMA transfers can occur between the processor's internal memories and any of its DMA-capable peripherals. Additionally, DMA transfers can be accomplished between any of the DMA-capable peripherals and external devices connected to the external memory interfaces, including the SDRAM controller and the asynchronous memory controller. DMA-capable peripherals include the Ethernet MAC, NFC, HOSTDP, USB, SPORTs, SPI port, UARTs, and PPI. Each individual DMA-capable peripheral has at least one dedicated DMA channel.

The processor DMA controller supports both one-dimensional (1-D) and two-dimensional (2-D) DMA transfers. DMA transfer initialization can be implemented from registers or from sets of parameters called descriptor blocks.

The 2-D DMA capability supports arbitrary row and column sizes up to 64K elements by 64K elements, and arbitrary row and column step sizes up to  $\pm 32K$  elements. Furthermore, the column step size can be less than the row step size, allowing implementation of interleaved data streams. This feature is especially useful in video applications where data can be de-interleaved on the fly.

Examples of DMA types supported by the processor DMA controller include:

- A single, linear buffer that stops upon completion.
- A circular, auto-refreshing buffer that interrupts on each full or fractionally full buffer.
- 1-D or 2-D DMA using a linked list of descriptors.
- 2-D DMA using an array of descriptors, specifying only the base DMA address within a common page.

In addition to the dedicated peripheral DMA channels, there are two memory DMA channels provided for transfers between the various memories of the processor system. This enables transfers of blocks of data between any of the memories—including external SDRAM, ROM, SRAM, and flash memory—with minimal processor intervention. Memory DMA transfers can be controlled by a very flexible descriptor-based methodology or by a standard register-based autobuffer mechanism.

The processor also has an external DMA controller capability via dual external DMA request pins when used in conjunction with the external bus interface unit (EBIU). This functionality can be used when a high speed interface is required for external FIFOs and high bandwidth communications peripherals such as USB 2.0. It allows control of the number of data transfers for memory DMA. The number of transfers per edge is programmable. This feature can be programmed to allow memory DMA to have an increased priority on the external bus relative to the core.

## HOST DMA PORT

The host port interface allows an external host to be a DMA master to transfer data in and out of the device. The host device masters the transactions and the Blackfin processor is the DMA slave.

The host port is enabled through the PAB interface. Once enabled, the DMA is controlled by the external host, which can then program the DMA to send/receive data to any valid internal or external memory location.

The host port interface controller has the following features.

- Allows external master to configure DMA read/write data transfers and read port status.
- Uses asynchronous memory protocol for external interface.
- 8-/16-bit external data interface to host device.
- Half duplex operation.
- Little-/big-endian data transfer.
- Acknowledge mode allows flow control on host transactions.
- Interrupt mode guarantees a burst of FIFO depth host transactions.

## REAL-TIME CLOCK

The real-time clock (RTC) provides a robust set of digital watch features, including current time, stopwatch, and alarm. The RTC is clocked by a 32.768 kHz crystal external to the Blackfin processor. Connect RTC pins RTXI and RTXO with external

# ADSP-BF522/ADSP-BF523/ADSP-BF524/ADSP-BF525/ADSP-BF526/ADSP-BF527

components as shown in Figure 4.

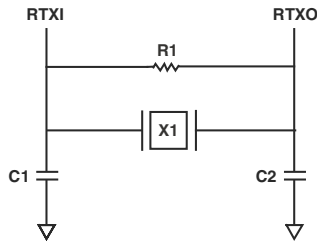

#### SUGGESTED COMPONENTS:

X1 = ECLIPTEK EC38J (THROUGH-HOLE PACKAGE) OR  
EPSON MC405 12 pF LOAD (SURFACE-MOUNT PACKAGE)

C1 = 22 pF

C2 = 22 pF

R1 = 10 MΩ

NOTE: C1 AND C2 ARE SPECIFIC TO CRYSTAL SPECIFIED FOR X1.  
CONTACT CRYSTAL MANUFACTURER FOR DETAILS. C1 AND C2  
SPECIFICATIONS ASSUME BOARD TRACE CAPACITANCE OF 3 pF.

Figure 4. External Components for RTC

The RTC peripheral has dedicated power supply pins so that it can remain powered up and clocked even when the rest of the processor is in a low power state. The RTC provides several programmable interrupt options, including interrupt per second, minute, hour, or day clock ticks, interrupt on programmable stopwatch countdown, or interrupt at a programmed alarm time.

The 32.768 kHz input clock frequency is divided down to a 1 Hz signal by a prescaler. The counter function of the timer consists of four counters: a 60-second counter, a 60-minute counter, a 24-hour counter, and an 32,768-day counter.

When enabled, the alarm function generates an interrupt when the output of the timer matches the programmed value in the alarm control register. There are two alarms: The first alarm is for a time of day. The second alarm is for a day and time of that day.

The stopwatch function counts down from a programmed value, with one-second resolution. When the stopwatch is enabled and the counter underflows, an interrupt is generated.

Like the other peripherals, the RTC can wake up the processor from sleep mode upon generation of any RTC wake-up event. Additionally, an RTC wakeup event can wake up the processor from deep sleep mode or cause a transition from the hibernate state.

## WATCHDOG TIMER

The processor includes a 32-bit timer that can be used to implement a software watchdog function. A software watchdog can improve system availability by forcing the processor to a known state through generation of a hardware reset, nonmaskable interrupt (NMI), or general-purpose interrupt, if the timer expires before being reset by software. The programmer initializes the count value of the timer, enables the appropriate interrupt, then enables the timer. Thereafter, the software must reload the counter before it counts to zero from the programmed value. This protects the system from remaining in an

unknown state where software, which would normally reset the timer, has stopped running due to an external noise condition or software error.

If configured to generate a hardware reset, the watchdog timer resets both the core and the processor peripherals. After a reset, software can determine if the watchdog was the source of the hardware reset by interrogating a status bit in the watchdog timer control register.

The timer is clocked by the system clock (SCLK), at a maximum frequency of  $f_{SCLK}$ .

## TIMERS

There are nine general-purpose programmable timer units in the processors. Eight timers have an external pin that can be configured either as a pulse width modulator (PWM) or timer output, as an input to clock the timer, or as a mechanism for measuring pulse widths and periods of external events. These timers can be synchronized to an external clock input to the several other associated PF pins, an external clock input to the PPI\_CLK input pin, or to the internal SCLK.

The timer units can be used in conjunction with the two UARTs to measure the width of the pulses in the data stream to provide a software auto-baud detect function for the respective serial channels.

The timers can generate interrupts to the processor core providing periodic events for synchronization, either to the system clock or to a count of external signals.

In addition to the eight general-purpose programmable timers, a ninth timer is also provided. This extra timer is clocked by the internal processor clock and is typically used as a system tick clock for generation of operating system periodic interrupts.

## UP/DOWN COUNTER AND THUMBWHEEL INTERFACE

A 32-bit up/down counter is provided that can sense 2-bit quadrature or binary codes as typically emitted by industrial drives or manual thumb wheels. The counter can also operate in general-purpose up/down count modes. Then, count direction is either controlled by a level-sensitive input pin or by two edge detectors.

A third input can provide flexible zero marker support and can alternatively be used to input the push-button signal of thumb wheels. All three pins have a programmable debouncing circuit.

An internal signal forwarded to the timer unit enables one timer to measure the intervals between count events. Boundary registers enable auto-zero operation or simple system warning by interrupts when programmable count values are exceeded.

## SERIAL PORTS

The processors incorporate two dual-channel synchronous serial ports (SPORT0 and SPORT1) for serial and multiprocessor communications. The SPORTs support the following features:

- I<sup>2</sup>S capable operation.

- Bidirectional operation — Each SPORT has two sets of independent transmit and receive pins, enabling eight channels of I<sup>2</sup>S stereo audio.
- Buffered (8-deep) transmit and receive ports — Each port has a data register for transferring data words to and from other processor components and shift registers for shifting data in and out of the data registers.
- Clocking — Each transmit and receive port can either use an external serial clock or generate its own, in frequencies ranging from ( $f_{SCLK}/131,070$ ) Hz to ( $f_{SCLK}/2$ ) Hz.
- Word length — Each SPORT supports serial data words from 3 to 32 bits in length, transferred most-significant-bit first or least-significant-bit first.
- Framing — Each transmit and receive port can run with or without frame sync signals for each data word. Frame sync signals can be generated internally or externally, active high or low, and with either of two pulse widths and early or late frame sync.
- Companding in hardware — Each SPORT can perform A-law or  $\mu$ -law companding according to ITU recommendation G.711. Companding can be selected on the transmit and/or receive channel of the SPORT without additional latencies.
- DMA operations with single-cycle overhead — Each SPORT can automatically receive and transmit multiple buffers of memory data. The processor can link or chain sequences of DMA transfers between a SPORT and memory.
- Interrupts — Each transmit and receive port generates an interrupt upon completing the transfer of a data word or after transferring an entire data buffer, or buffers, through DMA.
- Multichannel capability — Each SPORT supports 128 channels out of a 1024-channel window and is compatible with the H.100, H.110, MVIP-90, and HMVIP standards.

## SERIAL PERIPHERAL INTERFACE (SPI) PORT

The processors have an SPI-compatible port that enables the processor to communicate with multiple SPI-compatible devices.

The SPI interface uses three pins for transferring data: two data pins (Master Output-Slave Input, MOSI, and Master Input-Slave Output, MISO) and a clock pin (serial clock, SCK). An SPI chip select input pin ( $\overline{SPISS}$ ) lets other SPI devices select the processor, and seven SPI chip select output pins ( $SPISEL7-1$ ) let the processor select other SPI devices. The SPI select pins are reconfigured general-purpose I/O pins. Using these pins, the SPI port provides a full-duplex, synchronous serial interface, which supports both master/slave modes and multimaster environments.

The SPI port's baud rate and clock phase/polarities are programmable, and it has an integrated DMA channel, configurable to support transmit or receive data streams. The SPI's DMA channel can only service unidirectional accesses at any given time.

The SPI port's clock rate is calculated as:

$$SPI\ Clock\ Rate = \frac{f_{SCLK}}{2 \times SPI\_BAUD}$$

Where the 16-bit SPI\_BAUD register contains a value of 2 to 65,535.

During transfers, the SPI port simultaneously transmits and receives by serially shifting data in and out on its two serial data lines. The serial clock line synchronizes the shifting and sampling of data on the two serial data lines.

## UART PORTS

The processors provide two full-duplex universal asynchronous receiver/transmitter (UART) ports, which are fully compatible with PC-standard UARTs. Each UART port provides a simplified UART interface to other peripherals or hosts, supporting full-duplex, DMA-supported, asynchronous transfers of serial data. A UART port includes support for five to eight data bits, one or two stop bits, and none, even, or odd parity. Each UART port supports two modes of operation:

- PIO (programmed I/O) — The processor sends or receives data by writing or reading I/O mapped UART registers. The data is double-buffered on both transmit and receive.
- DMA (direct memory access) — The DMA controller transfers both transmit and receive data. This reduces the number and frequency of interrupts required to transfer data to and from memory. The UART has two dedicated DMA channels, one for transmit and one for receive. These DMA channels have lower default priority than most DMA channels because of their relatively low service rates.

Each UART port's baud rate, serial data format, error code generation and status, and interrupts are programmable:

- Supporting bit rates ranging from ( $f_{SCLK}/1,048,576$ ) to ( $f_{SCLK}/16$ ) bits per second.
- Supporting data formats from seven to 12 bits per frame.
- Both transmit and receive operations can be configured to generate maskable interrupts to the processor.

The UART port's clock rate is calculated as:

$$UART\ Clock\ Rate = \frac{f_{SCLK}}{16 \times UART\_Divisor}$$

Where the 16-bit UART\_Divisor comes from the UART\_DLH (most significant 8 bits) and UART\_DLL (least significant 8 bits) registers.

In conjunction with the general-purpose timer functions, auto-baud detection is supported.

The capabilities of the UARTs are further extended with support for the infrared data association (IrDA<sup>®</sup>) serial infrared physical layer link specification (SIR) protocol.

## TWI CONTROLLER INTERFACE

The processors include a 2-wire interface (TWI) module for providing a simple exchange method of control data between multiple devices. The TWI is compatible with the widely used I<sup>2</sup>C<sup>®</sup> bus standard. The TWI module offers the capabilities of simultaneous master and slave operation and support for both 7-bit addressing and multimedia data arbitration. The TWI interface utilizes two pins for transferring clock (SCL) and data (SDA) and supports the protocol at speeds up to 400k bits/sec. The TWI interface pins are compatible with 5 V logic levels.

Additionally, the TWI module is fully compatible with serial camera control bus (SCCB) functionality for easier control of various CMOS camera sensor devices.

## 10/100 ETHERNET MAC

The ADSP-BF526 and ADSP-BF527 processors offer the capability to directly connect to a network by way of an embedded Fast Ethernet Media Access Controller (MAC) that supports both 10-BaseT (10M bits/sec) and 100-BaseT (100M bits/sec) operation. The 10/100 Ethernet MAC peripheral on the processor is fully compliant to the IEEE 802.3-2002 standard and it provides programmable features designed to minimize supervision, bus use, or message processing by the rest of the processor system.

Some standard features are:

- Support of MII and RMII protocols for external PHYs.
- Full duplex and half duplex modes.
- Data framing and encapsulation: generation and detection of preamble, length padding, and FCS.
- Media access management (in half-duplex operation): collision and contention handling, including control of retransmission of collision frames and of back-off timing.
- Flow control (in full-duplex operation): generation and detection of PAUSE frames.
- Station management: generation of MDC/MDIO frames for read-write access to PHY registers.
- Operating range for active and sleep operating modes, see [Table 58 on Page 67](#) and [Table 59 on Page 67](#).
- Internal loopback from Tx to Rx.

Some advanced features are:

- Buffered crystal output to external PHY for support of a single crystal system.
- Automatic checksum computation of IP header and IP payload fields of Rx frames.
- Independent 32-bit descriptor-driven Rx and Tx DMA channels.
- Frame status delivery to memory via DMA, including frame completion semaphores, for efficient buffer queue management in software.
- Tx DMA support for separate descriptors for MAC header and payload to eliminate buffer copy operations.

- Convenient frame alignment modes support even 32-bit alignment of encapsulated Rx or Tx IP packet data in memory after the 14-byte MAC header.
- Programmable Ethernet event interrupt supports any combination of:
  - Any selected Rx or Tx frame status conditions.
  - PHY interrupt condition.
  - Wake-up frame detected.
  - Any selected MAC management counter(s) at half-full.
  - DMA descriptor error.
- 47 MAC management statistics counters with selectable clear-on-read behavior and programmable interrupts on half maximum value.
- Programmable Rx address filters, including a 64-bin address hash table for multicast and/or unicast frames, and programmable filter modes for broadcast, multicast, unicast, control, and damaged frames.
- Advanced power management supporting unattended transfer of Rx and Tx frames and status to/from external memory via DMA during low power sleep mode.
- System wakeup from sleep operating mode upon magic packet or any of four user-definable wakeup frame filters.
- Support for 802.3Q tagged VLAN frames.
- Programmable MDC clock rate and preamble suppression.
- In RMII operation, seven unused pins may be configured as GPIO pins for other purposes.

## PORTS

Because of the rich set of peripherals, the processor groups the many peripheral signals to four ports—Port F, Port G, Port H, and Port J. Most of the associated pins are shared by multiple signals. The ports function as multiplexer controls.

### General-Purpose I/O (GPIO)

The processor has 48 bidirectional, general-purpose I/O (GPIO) pins allocated across three separate GPIO modules—PORTFIO, PORTGIO, and PORTHIO, associated with Port F, Port G, and Port H, respectively. Port J does not provide GPIO functionality. Each GPIO-capable pin shares functionality with other processor peripherals via a multiplexing scheme; however, the GPIO functionality is the default state of the device upon power-up. Neither GPIO output nor input drivers are active by default. Each general-purpose port pin can be individually controlled by manipulation of the port control, status, and interrupt registers:

- GPIO direction control register — Specifies the direction of each individual GPIO pin as input or output.
- GPIO control and status registers — The processor employs a “write one to modify” mechanism that allows any combination of individual GPIO pins to be modified in a single instruction, without affecting the level of any other GPIO pins. Four control registers are provided. One regis-

ter is written in order to set pin values, one register is written in order to clear pin values, one register is written in order to toggle pin values, and one register is written in order to specify a pin value. Reading the GPIO status register allows software to interrogate the sense of the pins.

- GPIO interrupt mask registers — The two GPIO interrupt mask registers allow each individual GPIO pin to function as an interrupt to the processor. Similar to the two GPIO control registers that are used to set and clear individual pin values, one GPIO interrupt mask register sets bits to enable interrupt function, and the other GPIO interrupt mask register clears bits to disable interrupt function. GPIO pins defined as inputs can be configured to generate hardware interrupts, while output pins can be triggered by software interrupts.
- GPIO interrupt sensitivity registers — The two GPIO interrupt sensitivity registers specify whether individual pins are level- or edge-sensitive and specify—if edge-sensitive—whether just the rising edge or both the rising and falling edges of the signal are significant. One register selects the type of sensitivity, and one register selects which edges are significant for edge-sensitivity.

## PARALLEL PERIPHERAL INTERFACE (PPI)

The processor provides a parallel peripheral interface (PPI) that can connect directly to parallel analog-to-digital and digital-to-analog converters, video encoders and decoders, and other general-purpose peripherals. The PPI consists of a dedicated input clock pin, up to three frame synchronization pins, and up to 16 data pins. The input clock supports parallel data rates up to half the system clock rate, and the synchronization signals can be configured as either inputs or outputs.

The PPI supports a variety of general-purpose and ITU-R 656 modes of operation. In general-purpose mode, the PPI provides half-duplex, bidirectional data transfer with up to 16 bits of data. Up to three frame synchronization signals are also provided. In ITU-R 656 mode, the PPI provides half-duplex bidirectional transfer of 8- or 10-bit video data. Additionally, on-chip decode of embedded start-of-line (SOL) and start-of-field (SOF) preamble packets is supported.

### General-Purpose Mode Descriptions

The general-purpose modes of the PPI are intended to suit a wide variety of data capture and transmission applications. Three distinct submodes are supported:

1. Input mode — Frame syncs and data are inputs into the PPI.
2. Frame capture mode — Frame syncs are outputs from the PPI, but data are inputs.
3. Output mode — Frame syncs and data are outputs from the PPI.

### Input Mode

Input mode is intended for ADC applications, as well as video communication with hardware signaling. In its simplest form, PPI\_FS1 is an external frame sync input that controls when to

read data. The PPI\_DELAY MMR allows for a delay (in PPI\_CLK cycles) between reception of this frame sync and the initiation of data reads. The number of input data samples is user programmable and defined by the contents of the PPI\_COUNT register. The PPI supports 8-bit and 10-bit through 16-bit data, programmable in the PPI\_CONTROL register.

### Frame Capture Mode

Frame capture mode allows the video source(s) to act as a slave (for frame capture for example). The ADSP-BF52x processors control when to read from the video source(s). PPI\_FS1 is an HSYNC output, and PPI\_FS2 is a VSYNC output.

### Output Mode

Output mode is used for transmitting video or other data with up to three output frame syncs. Typically, a single frame sync is appropriate for data converter applications, whereas two or three frame syncs could be used for sending video with hardware signaling.

### ITU-R 656 Mode Descriptions

The ITU-R 656 modes of the PPI are intended to suit a wide variety of video capture, processing, and transmission applications. Three distinct submodes are supported:

1. Active video only mode
2. Vertical blanking only mode
3. Entire field mode

### Active Video Mode

Active video only mode is used when only the active video portion of a field is of interest and not any of the blanking intervals. The PPI does not read in any data between the end of active video (EAV) and start of active video (SAV) preamble symbols, or any data present during the vertical blanking intervals. In this mode, the control byte sequences are not stored to memory; they are filtered by the PPI. After synchronizing to the start of Field 1, the PPI ignores incoming samples until it sees an SAV code. The user specifies the number of active video lines per frame (in PPI\_COUNT register).

### Vertical Blanking Interval Mode

In this mode, the PPI only transfers vertical blanking interval (VBI) data.

### Entire Field Mode

In this mode, the entire incoming bit stream is read in through the PPI. This includes active video, control preamble sequences, and ancillary data that may be embedded in horizontal and vertical blanking intervals. Data transfer starts immediately after synchronization to Field 1. Data is transferred to or from the synchronous channels through eight DMA engines that work autonomously from the processor core.

## USB ON-THE-GO DUAL-ROLE DEVICE CONTROLLER

The USB OTG dual-role device controller (USBDRD) provides a low-cost connectivity solution for consumer mobile devices such as cell phones, digital still cameras, and MP3 players, allowing these devices to transfer data using a point-to-point USB connection without the need for a PC host. The USBDRD module can operate in a traditional USB peripheral-only mode as well as the host mode presented in the On-the-Go (OTG) supplement to the USB 2.0 specification. In host mode, the USB module supports transfers at high speed (480 Mbps), full speed (12 Mbps), and low speed (1.5 Mbps) rates. Peripheral-only mode supports the high- and full-speed transfer rates.

The USB clock (USB\_XI) is provided through a dedicated external crystal or crystal oscillator. See [Universal Serial Bus \(USB\) On-The-Go—Receive and Transmit Timing on Page 59](#) for related timing requirements. If using a crystal to provide the USB clock, use a parallel-resonant, fundamental mode, micro-processor-grade crystal.

The USB on-the-go dual-role device controller includes a phase locked loop with programmable multipliers to generate the necessary internal clocking frequency for USB. The multiplier value should be programmed based on the USB\_XI frequency to achieve the necessary 480 MHz internal clock for USB high speed operation. For example, for a USB\_XI crystal frequency of 24 MHz, the USB\_PLLOSC\_CTRL register should be programmed with a multiplier value of 20 to generate a 480 MHz internal clock.

## CODE SECURITY WITH LOCKBOX SECURE TECHNOLOGY

A security system consisting of a blend of hardware and software provides customers with a flexible and rich set of code security features with Lockbox™ Secure Technology. Key features include:

- OTP memory
- Unique chip ID
- Code authentication
- Secure mode of operation

The security scheme is based upon the concept of authentication of digital signatures using standards-based algorithms and provides a secure processing environment in which to execute code and protect assets. See [Lockbox Secure Technology Disclaimer on Page 21](#).

## DYNAMIC POWER MANAGEMENT

The processor provides five operating modes, each with a different performance/power profile. In addition, dynamic power management provides the control functions to dynamically alter the processor core supply voltage, further reducing power dissipation. When configured for a 0 V core supply voltage, the processor enters the hibernate state. Control of clocking to each of the processor peripherals also reduces power consumption.

See [Table 4](#) for a summary of the power settings for each mode.

**Table 4. Power Settings**

Mode/State	PLL	PLL Bypassed	Core Clock (CCLK)	System Clock (SCLK)	Core Power
Full-On	Enabled	No	Enabled	Enabled	On
Active	Enabled/Disabled	Yes	Enabled	Enabled	On
Sleep	Enabled	—	Disabled	Enabled	On
Deep Sleep	Disabled	—	Disabled	Disabled	On
Hibernate	Disabled	—	Disabled	Disabled	Off

### Full-On Operating Mode—Maximum Performance

In the full-on mode, the PLL is enabled and is not bypassed, providing capability for maximum operational frequency. This is the power-up default execution state in which maximum performance can be achieved. The processor core and all enabled peripherals run at full speed.

### Active Operating Mode—Moderate Dynamic Power Savings

In the active mode, the PLL is enabled but bypassed. Because the PLL is bypassed, the processor's core clock (CCLK) and system clock (SCLK) run at the input clock (CLKIN) frequency. DMA access is available to appropriately configured L1 memories.

In the active mode, it is possible to disable the control input to the PLL by setting the PLL\_OFF bit in the PLL control register. This register can be accessed with a user-callable routine in the on-chip ROM called `bfrom_SysControl()`. If disabled, the PLL control input must be re-enabled before transitioning to the full-on or sleep modes.

For more information about PLL controls, see the “Dynamic Power Management” chapter in the ADSP-BF52x Blackfin Processor Hardware Reference.

### Sleep Operating Mode—High Dynamic Power Savings

The sleep mode reduces dynamic power dissipation by disabling the clock to the processor core (CCLK). The PLL and system clock (SCLK), however, continue to operate in this mode. Typically, an external event or RTC activity wakes up the processor. When in the sleep mode, asserting a wakeup enabled in the SIC\_IWRx registers causes the processor to sense the value of the BYPASS bit in the PLL control register (PLL\_CTL). If BYPASS is disabled, the processor transitions to the full-on mode. If BYPASS is enabled, the processor transitions to the active mode.

System DMA access to L1 memory is not supported in sleep mode.

### Deep Sleep Operating Mode—Maximum Dynamic Power Savings

The deep sleep mode maximizes dynamic power savings by disabling the clocks to the processor core (CCLK) and to all synchronous peripherals (SCLK). Asynchronous peripherals,

such as the RTC, may still be running but cannot access internal resources or external memory. This powered-down mode can only be exited by assertion of the reset interrupt (RESET) or by an asynchronous interrupt generated by the RTC. When in deep sleep mode, an RTC asynchronous interrupt causes the processor to transition to the Active mode. Assertion of RESET while in deep sleep mode causes the processor to transition to the full on mode.

### Hibernate State—Maximum Static Power Savings

The hibernate state maximizes static power savings by disabling the voltage and clocks to the processor core (CCLK) and to all of the synchronous peripherals (SCLK). The internal voltage regulator (ADSP-BF523/ADSP-BF525/ADSP-BF527 only) for the processor can be shut off by writing b#00 to the `FREQ` bits of the `VR_CTL` register, using the `bfrom_SysControl()` function. This setting sets the internal power supply voltage ( $V_{DDINT}$ ) to 0 V to provide the lowest static power dissipation. Any critical information stored internally (for example, memory contents, register contents, and other information) must be written to a non volatile storage device prior to removing power if the processor state is to be preserved. Writing b#00 to the `FREQ` bits also causes `EXT_WAKE0` and `EXT_WAKE1` to transition low, which can be used to signal an external voltage regulator to shut down.

Since  $V_{DDEXT}$  and  $V_{DDMEM}$  can still be supplied in this mode, all of the external pins three-state, unless otherwise specified. This allows other devices that may be connected to the processor to still have power applied without drawing unwanted current.

The Ethernet or USB modules can wake up the internal supply regulator (ADSP-BF525 and ADSP-BF527 only) or signal an external regulator to wake up using `EXT_WAKE0` or `EXT_WAKE1`. If PG15 does not connect as a `PHYINT` signal to an external PHY device, PG15 can be pulled low by any other device to wake the processor up. The processor can also be woken up by a real-time clock wakeup event or by asserting the `RESET` pin. All hibernate wake-up events initiate the hardware reset sequence. Individual sources are enabled by the `VR_CTL` register. The `EXT_WAKEx` signals are provided to indicate the occurrence of wake-up events.

As long as  $V_{DDEXT}$  is applied, the `VR_CTL` register maintains its state during hibernation. All other internal registers and memories, however, lose their content in the hibernate state. State variables may be held in external SRAM or SDRAM. The `SCKELOW` bit in the `VR_CTL` register controls whether or not SDRAM operates in self-refresh mode, which allows it to retain its content while the processor is in hibernate and through the subsequent reset sequence.

### Power Savings

As shown in Table 5, the processor supports six different power domains, which maximizes flexibility while maintaining compliance with industry standards and conventions. By isolating the internal logic of the processor into its own power domain, separate from the RTC and other I/O, the processor can take advantage of dynamic power management without affecting the RTC or other I/O devices. There are no sequencing require-

ments for the various power domains, but all domains must be powered according to the appropriate Specifications table for processor Operating Conditions; even if the feature/peripheral is not used.

**Table 5. Power Domains**

Power Domain	V <sub>DD</sub> Range
All internal logic, except RTC, Memory, USB, OTP	V <sub>DDINT</sub>
RTC internal logic and crystal I/O	V <sub>DDRTC</sub>
Memory logic	V <sub>DDMEM</sub>
USB PHY logic	V <sub>DDUSB</sub>
OTP logic	V <sub>DDOTP</sub>
All other I/O	V <sub>DDEXT</sub>

The dynamic power management feature of the processor allows both the processor's input voltage ( $V_{DDINT}$ ) and clock frequency ( $f_{CCLK}$ ) to be dynamically controlled.

The power dissipated by a processor is largely a function of its clock frequency and the square of the operating voltage. For example, reducing the clock frequency by 25% results in a 25% reduction in dynamic power dissipation, while reducing the voltage by 25% reduces dynamic power dissipation by more than 40%. Further, these power savings are additive, in that if the clock frequency and supply voltage are both reduced, the power savings can be dramatic, as shown in the following equations.

*Power Savings Factor*

$$= \frac{f_{CCLKRED}}{f_{CCLKNOM}} \times \left( \frac{V_{DDINTRED}}{V_{DDINTNOM}} \right)^2 \times \left( \frac{T_{RED}}{T_{NOM}} \right)$$

$$\% \text{ Power Savings} = (1 - \text{Power Savings Factor}) \times 100\%$$

where the variables in the equations are:

$f_{CCLKNOM}$  is the nominal core clock frequency

$f_{CCLKRED}$  is the reduced core clock frequency

$V_{DDINTNOM}$  is the nominal internal supply voltage

$V_{DDINTRED}$  is the reduced internal supply voltage

$T_{NOM}$  is the duration running at  $f_{CCLKNOM}$

$T_{RED}$  is the duration running at  $f_{CCLKRED}$

## ADSP-BF523/ADSP-BF525/ADSP-BF527 VOLTAGE REGULATION

The ADSP-BF523/ADSP-BF525/ADSP-BF527 provides an on-chip voltage regulator that can generate processor core voltage levels from an external supply. Figure 5 shows the typical external components required to complete the power management system.

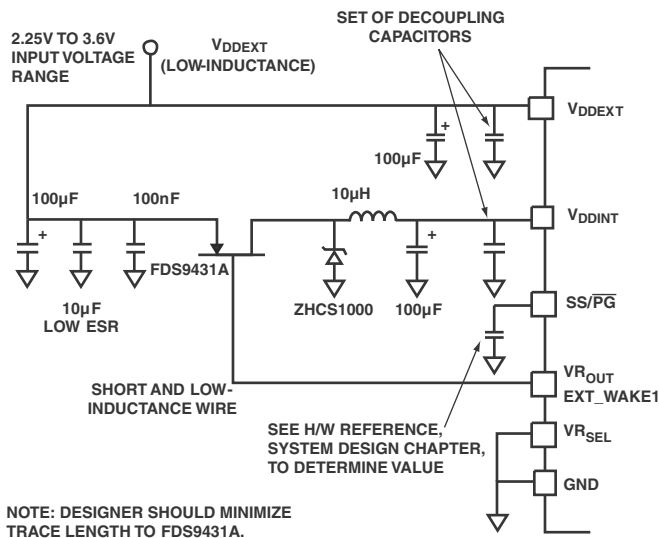

Figure 5. ADSP-BF523/ADSP-BF525/ADSP-BF527 Voltage Regulator Circuit

The regulator controls the internal logic voltage levels and is programmable with the voltage regulator control register (VR\_CTL) in increments of 50 mV. This register can be accessed using the `bfrom_SysControl()` function in the on-chip ROM. To reduce standby power consumption, the internal voltage regulator can be programmed to remove power to the processor core while keeping I/O power supplied. While in the hibernate state, all external supplies ( $V_{DDEXT}$ ,  $V_{DDMEM}$ ,  $V_{DDUSB}$ ,  $V_{DDOTP}$ ) can still be applied, eliminating the need for external buffers.  $V_{DDRTC}$  must be applied at all times for correct hibernate operation. The voltage regulator can be activated from this power-down state either through an RTC wakeup, a USB wakeup, an ethernet wake-up, or by asserting the RESET pin, each of which then initiates a boot sequence. The regulator can also be disabled and bypassed at the user's discretion.

The voltage regulator has two modes set by the VR\_SEL pin—the normal pulse width control of an external FET and the external supply mode which can signal a power down during hibernate to an external regulator. Set VR\_SEL to  $V_{DDEXT}$  to use an external regulator or set VR\_SEL to GND to use the internal regulator. In the external mode VR\_OUT becomes EXT\_WAKE1. If the internal regulator is used, EXT\_WAKE0 can control other power sources in the system during the hibernate state. Both signals are high-true for power-up and may be connected directly to the low-true shutdown input of many common regulators. The mode of the SS/P̄G (Soft Start/Power Good) signal also changes according to the state of VR\_SEL. When using an internal regulator, the SS/P̄G pin is Soft Start, and when using an external

regulator, it is Power Good. The Soft Start feature is recommended to reduce the inrush currents and to reduce  $V_{DDINT}$  voltage overshoot when coming out of hibernate or changing voltage levels. The Power Good (P̄G) input signal allows the processor to start only after the internal voltage has reached a chosen level. In this way, the startup time of the external regulator is detected after hibernation. For a complete description of Soft Start and Power Good functionality, refer to the *ADSP-BF52x Blackfin Processor Hardware Reference*.

## ADSP-BF522/ADSP-BF524/ADSP-BF526 VOLTAGE REGULATION

The ADSP-BF522/ADSP-BF524/ADSP-BF526 processor requires an external voltage regulator to power the  $V_{DDINT}$  domain. To reduce standby power consumption, the external voltage regulator can be signaled through EXT\_WAKE0 or EXT\_WAKE1 to remove power from the processor core. These identical signals are high-true for power-up and may be connected directly to the low-true shut down input of many common regulators. While in the hibernate state, all external supplies ( $V_{DDEXT}$ ,  $V_{DDMEM}$ ,  $V_{DDUSB}$ ,  $V_{DDOTP}$ ) can still be applied, eliminating the need for external buffers.  $V_{DDRTC}$  must be applied at all times for correct hibernate operation. The external voltage regulator can be activated from this power down state either through an RTC wakeup, a USB wakeup, an ethernet wakeup, or by asserting the RESET pin, each of which then initiates a boot sequence. EXT\_WAKE0 or EXT\_WAKE1 indicate a wakeup to the external voltage regulator. The Power Good (P̄G) input signal allows the processor to start only after the internal voltage has reached a chosen level. In this way, the startup time of the external regulator is detected after hibernation. For a complete description of the Power Good functionality, refer to the *ADSP-BF52x Blackfin Processor Hardware Reference*.

## CLOCK SIGNALS

The processor can be clocked by an external crystal, a sine wave input, or a buffered, shaped clock derived from an external clock oscillator.

If an external clock is used, it should be a TTL compatible signal and must not be halted, changed, or operated below the specified frequency during normal operation. This signal is connected to the processor's CLKIN pin. When an external clock is used, the XTAL pin must be left unconnected.

Alternatively, because the processor includes an on-chip oscillator circuit, an external crystal may be used. For fundamental frequency operation, use the circuit shown in Figure 6. A parallel-resonant, fundamental frequency, microprocessor-grade crystal is connected across the CLKIN and XTAL pins. The on-chip resistance between CLKIN and the XTAL pin is in the 500 kΩ range. Further parallel resistors are typically not recommended. The two capacitors and the series resistor shown in Figure 6 fine tune phase and amplitude of the sine frequency.

The capacitor and resistor values shown in Figure 6 are typical values only. The capacitor values are dependent upon the crystal manufacturers' load capacitance recommendations and the PCB physical layout. The resistor value depends on the drive level



# ADSP-BF522/ADSP-BF523/ADSP-BF524/ADSP-BF525/ADSP-BF526/ADSP-BF527

specified by the crystal manufacturer. The user should verify the customized values based on careful investigations on multiple devices over temperature range.



NOTE: VALUES MARKED WITH \* MUST BE CUSTOMIZED, DEPENDING ON THE CRYSTAL AND LAYOUT. PLEASE ANALYZE CAREFULLY. FOR FREQUENCIES ABOVE 33 MHz, THE SUGGESTED CAPACITOR VALUE OF 18 pF SHOULD BE TREATED AS A MAXIMUM, AND THE SUGGESTED RESISTOR VALUE SHOULD BE REDUCED TO 0  $\Omega$ .

Figure 6. External Crystal Connections

A third-overtone crystal can be used for frequencies above 25 MHz. The circuit is then modified to ensure crystal operation only at the third overtone by adding a tuned inductor circuit as shown in Figure 6. A design procedure for third-overtone operation is discussed in detail in application note (EE-168) *Using Third Overtone Crystals with the ADSP-218x DSP* on the Analog Devices website ([www.analog.com](http://www.analog.com))—use site search on “EE-168.”

The CLKBUF pin is an output pin, which is a buffered version of the input clock. This pin is particularly useful in Ethernet applications to limit the number of required clock sources in the system. In this type of application, a single 25 MHz or 50 MHz crystal may be applied directly to the processor. The 25 MHz or 50 MHz output of CLKBUF can then be connected to an external Ethernet MII or RMII PHY device. If, instead of a crystal, an external oscillator is used at CLKIN, CLKBUF will not have the 40/60 duty cycle required by some devices. The CLKBUF output is active by default and can be disabled for power savings reasons using the VR\_CTL register.

The Blackfin core runs at a different clock rate than the on-chip peripherals. As shown in Figure 7, the core clock (CCLK) and system peripheral clock (SCLK) are derived from the input clock (CLKIN) signal. An on-chip PLL is capable of multiplying the CLKIN signal by a programmable multiplication factor (bounded by specified minimum and maximum VCO frequencies). The default multiplier can be modified by a software instruction sequence. This sequence is managed by the bfrom\_SysControl() function in the on-chip ROM.

On-the-fly CCLK and SCLK frequency changes can be applied by using the bfrom\_SysControl() function in the on-chip ROM. The maximum allowed CCLK and SCLK rates depend on the applied voltages  $V_{DDINT}$ ,  $V_{DDEXT}$ , and  $V_{DDMEM}$ ; the VCO is always

permitted to run up to the frequency specified by the part’s maximum instruction rate. The CLKOUT pin reflects the SCLK frequency to the off-chip world. It is part of the SDRAM interface, but it functions as a reference signal in other timing specifications as well. While active by default, it can be disabled using the EBIU\_SDGCTL and EBIU\_AMGCTL registers.



Figure 7. Frequency Modification Methods

All on-chip peripherals are clocked by the system clock (SCLK). The system clock frequency is programmable by means of the SSEL3–0 bits of the PLL\_DIV register. The values programmed into the SSEL fields define a divide ratio between the PLL output (VCO) and the system clock. SCLK divider values are 1 through 15. Table 6 illustrates typical system clock ratios.

Note that the divisor ratio must be chosen to limit the system clock frequency to its maximum of  $f_{SCLK}$ . The SSEL value can be dynamically changed without any PLL lock latencies by writing the appropriate values to the PLL divisor register (PLL\_DIV) using the bfrom\_SysControl() function in the on-chip ROM.

Table 6. Example System Clock Ratios

Signal Name SSEL3–0	Divider Ratio VCO/SCLK	Example Frequency Ratios (MHz)	
		VCO	SCLK
0001	1:1	100	100
0110	6:1	300	50
1010	10:1	500	50

The core clock (CCLK) frequency can also be dynamically changed by means of the CSEL1–0 bits of the PLL\_DIV register. Supported CCLK divider ratios are 1, 2, 4, and 8, as shown in Table 7. This programmable core clock capability is useful for fast core frequency modifications.

Table 7. Core Clock Ratios

Signal Name CSEL1–0	Divider Ratio VCO/CCLK	Example Frequency Ratios (MHz)	
		VCO	CCLK
00	1:1	300	300
01	2:1	300	150
10	4:1	500	125
11	8:1	200	25

# ADSP-BF522/ADSP-BF523/ADSP-BF524/ADSP-BF525/ADSP-BF526/ADSP-BF527

The maximum CCLK frequency not only depends on the part's maximum instruction rate (see Page 87). This frequency also depends on the applied  $V_{DDINT}$  voltage. See Table 12 and Table 15 for details. The maximal system clock rate (SCLK) depends on the chip package and the applied  $V_{DDINT}$ ,  $V_{DDEXT}$ , and  $V_{DDMEM}$  voltages (see Table 14 and Table 17).

## BOOTING MODES

The processor has several mechanisms (listed in Table 8) for automatically loading internal and external memory after a reset. The boot mode is defined by four BMODE input pins dedicated to this purpose. There are two categories of boot modes. In master boot modes the processor actively loads data from parallel or serial memories. In slave boot modes the processor receives data from external host devices.

The boot modes listed in Table 8 provide a number of mechanisms for automatically loading the processor's internal and external memories after a reset. By default, all boot modes use the slowest meaningful configuration settings. Default settings can be altered via the initialization code feature at boot time or by proper OTP programming at pre-boot time. The BMODE pins of the reset configuration register, sampled during power-on resets and software-initiated resets, implement the modes shown in Table 8.

Table 8. Booting Modes

BMODE3-0	Description
0000	Idle — No boot
0001	Boot from 8- or 16-bit external flash memory
0010	Boot from 16-bit asynchronous FIFO
0011	Boot from serial SPI memory (EEPROM or flash)
0100	Boot from SPI host device
0101	Boot from serial TWI memory (EEPROM/flash)
0110	Boot from TWI host
0111	Boot from UART0 Host
1000	Boot from UART1 Host
1001	Reserved
1010	Boot from SDRAM
1011	Boot from OTP memory
1100	Boot from 8-bit NAND flash via NFC using PORTF data pins
1101	Boot from 8-bit NAND flash via NFC using PORTH data pins
1110	Boot from 16-Bit Host DMA
1111	Boot from 8-Bit Host DMA

- Idle/no boot mode (BMODE = 0x0) — In this mode, the processor goes into idle. The idle boot mode helps recover from illegal operating modes, such as when the OTP memory has been misconfigured.
- Boot from 8-bit or 16-bit external flash memory (BMODE = 0x1) — In this mode, the boot kernel loads the first block header from address 0x2000 0000, and (depending on instructions contained in the header) the boot

kernel performs an 8- or 16-bit boot or starts program execution at the address provided by the header. By default, all configuration settings are set for the slowest device possible (3-cycle hold time, 15-cycle R/W access times, 4-cycle setup).

The ARDY is not enabled by default, but it can be enabled through OTP programming. Similarly, all interface behavior and timings can be customized through OTP programming. This includes activation of burst-mode or page-mode operation. In this mode, all asynchronous interface signals are enabled at the port muxing level.

- Boot from 16-bit asynchronous FIFO (BMODE = 0x2) — In this mode, the boot kernel starts booting from address 0x2030 0000. Every 16-bit word that the boot kernel has to read from the FIFO must be requested by placing a low pulse on the DMAR1 pin.
- Boot from serial SPI memory, EEPROM or flash (BMODE = 0x3) — 8-, 16-, 24-, or 32-bit addressable devices are supported. The processor uses the PG1 GPIO pin to select a single SPI EEPROM/flash device and submits a read command and successive address bytes (0x00) until a valid 8-, 16-, 24-, or 32-bit addressable device is detected. Pull-up resistors are required on the  $\overline{\text{SPISEL1}}$  and MISO pins. By default, a value of 0x85 is written to the SPI\_BAUD register.
- Boot from SPI host device (BMODE = 0x4) — The processor operates in SPI slave mode and is configured to receive the bytes of the LDR file from an SPI host (master) agent. The HWAIT signal must be interrogated by the host before every transmitted byte. A pull-up resistor is required on the  $\overline{\text{SPISS}}$  input. A pull-down on the serial clock (SCK) may improve signal quality and booting robustness.
- Boot from serial TWI memory, EEPROM/flash (BMODE = 0x5) — The processor operates in master mode and selects the TWI slave connected to the TWI with the unique ID 0xA0.

The processor submits successive read commands to the memory device starting at internal address 0x0000 and begins clocking data into the processor. The TWI memory device should comply with the Philips I<sup>2</sup>C<sup>®</sup> Bus Specification version 2.1 and should be able to auto-increment its internal address counter such that the contents of the memory device can be read sequentially. By default, a PRESCALE value of 0xA and a TWI\_CLKDIV value of 0x0811 are used. Unless altered by OTP settings, an I<sup>2</sup>C memory that takes two address bytes is assumed. The development tools ensure that data booted to memories that cannot be accessed by the Blackfin core is written to an intermediate storage location and then copied to the final destination via memory DMA.

- Boot from TWI host (BMODE = 0x6) — The TWI host selects the slave with the unique ID 0x5F.

The processor replies with an acknowledgement and the host then downloads the boot stream. The TWI host agent should comply with the Philips I<sup>2</sup>C Bus Specification

version 2.1. An I<sup>2</sup>C multiplexer can be used to select one processor at a time when booting multiple processors from a single TWI.

- Boot from UART0 host on Port G (BMODE = 0x7) — Using an autobaud handshake sequence, a boot-stream formatted program is downloaded by the host. The host selects a bit rate within the UART clocking capabilities.

When performing the autobaud, the UART expects a “@” (0x40) character (eight bits data, one start bit, one stop bit, no parity bit) on the UART0RX pin to determine the bit rate. The UART then replies with an acknowledgement composed of 4 bytes (0xBF, the value of UART0\_DLL, the value of UART0\_DLH, then 0x00). The host can then download the boot stream. To hold off the host the Blackfin processor signals the host with the boot host wait (HWAIT) signal. Therefore, the host must monitor HWAIT before every transmitted byte.

- Boot from UART1 host on Port F (BMODE = 0x8). Same as BMODE = 0x7 except that the UART1 port is used.
- Boot from SDRAM (BMODE = 0xA) This is a warm boot scenario, where the boot kernel starts booting from address 0x0000 0010. The SDRAM is expected to contain a valid boot stream and the SDRAM controller must be configured by the OTP settings.
- Boot from OTP memory (BMODE = 0xB) — This provides a stand-alone booting method. The boot stream is loaded from on-chip OTP memory. By default, the boot stream is expected to start from OTP page 0x40 and can occupy all public OTP memory up to page 0xDF. This is 2560 bytes. Since the start page is programmable, the maximum size of the boot stream can be extended to 3072 bytes.
- Boot from 8-bit external NAND flash memory (BMODE = 0xC and BMODE = 0xD) — In this mode, auto detection of the NAND flash device is performed.

BMODE = 0xC, the processor configures PORTF GPIO pins PF7:0 for the NAND data pins and PORTH pins PH15:10 for the NAND control signals.

BMODE = 0xD, the processor configures PORTH GPIO pins PH7:0 for the NAND data pins and PORTH pins PH15:10 for the NAND control signals.

For correct device operation pull-up resistors are required on both  $\overline{ND\_CE}$  (PH10) and  $\overline{ND\_BUSY}$  (PH13) signals. By default, a value of 0x0033 is written to the NFC\_CTL register. The booting procedure always starts by booting from byte 0 of block 0 of the NAND flash device.

NAND flash boot supports the following features:

- Device Auto Detection
- Error Detection & Correction for maximum reliability
- No boot stream size limitation
- Peripheral DMA providing efficient transfer of all data (excluding the ECC parity data)

- Software-configurable boot mode for booting from boot streams spanning multiple blocks, including bad blocks

- Software-configurable boot mode for booting from multiple copies of the boot stream, allowing for handling of bad blocks and uncorrectable errors

- Configurable timing via OTP memory

Small page NAND flash devices must have a 512-byte page size, 32 pages per block, a 16-byte spare area size, and a bus configuration of 8 bits. By default, all read requests from the NAND flash are followed by four address cycles. If the NAND flash device requires only three address cycles, the device must be capable of ignoring the additional address cycles.

The small page NAND flash device must comply with the following command set:

- Reset: 0xFF
- Read lower half of page: 0x00
- Read upper half of page: 0x01
- Read spare area: 0x50

For large-page NAND-flash devices, the four-byte electronic signature is read in order to configure the kernel for booting, which allows support for multiple large-page devices. The fourth byte of the electronic signature must comply with the specification in [Table 9 on Page 20](#).

Any NAND flash array configuration from [Table 9](#), excluding 16-bit devices, that also complies with the command set listed below are directly supported by the boot kernel. There are no restrictions on the page size or block size as imposed by the small-page boot kernel.

For devices consisting of a five-byte signature, only four are read. The fourth must comply as outlined above.

Large page devices must support the following command set:

- Reset: 0xFF
- Read Electronic Signature: 0x90
- Read: 0x00, 0x30 (confirm command)

Large-page devices must not support or react to NAND flash command 0x50. This is a small-page NAND flash command used for device auto detection.

By default, the boot kernel will always issue five address cycles; therefore, if a large page device requires only four cycles, the device must be capable of ignoring the additional address cycles.

- Boot from 16-Bit Host DMA (BMODE = 0xE) — In this mode, the host DMA port is configured in 16-bit Acknowledge mode, with little endian data formatting. Unlike other modes, the host is responsible for interpreting the boot stream. It writes data blocks individually into the Host DMA port. Before configuring the DMA settings for each block, the host may either poll the ALLOW\_CONFIG bit in HOST\_STATUS or wait to be interrupted by the HWAIT

signal. When using HWAIT, the host must still check ALLOW\_CONFIG at least once before beginning to configure the Host DMA Port. After completing the configuration, the host is required to poll the READY bit in HOST\_STATUS before beginning to transfer data. When the host sends an HIRQ control command, the boot kernel issues a CALL instruction to address 0xFFA0 0000. It is the host's responsibility to ensure that valid code has been placed at this address. The routine at 0xFFA0 0000 can be a simple initialization routine to configure internal resources, such as the SDRAM controller, which then returns using an RTS instruction. The routine may also be the final application, which will never return to the boot kernel.

- **Boot from 8-Bit Host DMA (BMODE = 0xF)** — In this mode, the Host DMA port is configured in 8-bit interrupt mode, with little endian data formatting. Unlike other modes, the host is responsible for interpreting the boot stream. It writes data blocks individually into the Host DMA port. Before configuring the DMA settings for each block, the host may either poll the ALLOW\_CONFIG bit in HOST\_STATUS or wait to be interrupted by the HWAIT signal. When using HWAIT, the host must still check ALLOW\_CONFIG at least once before beginning to configure the Host DMA Port. The host will receive an interrupt from the HOST\_ACK signal every time it is allowed to send the next FIFO depths worth (sixteen 32-bit words) of information. When the host sends an HIRQ control command, the boot kernel issues a CALL instruction to address 0xFFA0 0000. It is the host's responsibility to ensure valid code has been placed at this address. The routine at 0xFFA0 0000 can be a simple initialization routine to configure internal resources, such as the SDRAM controller, which then returns using an RTS instruction. The routine may also be the final application, which will never return to the boot kernel.

## INSTRUCTION SET DESCRIPTION

The Blackfin processor family assembly language instruction set employs an algebraic syntax designed for ease of coding and readability. The instructions have been specifically tuned to provide a flexible, densely encoded instruction set that compiles to a very small final memory size. The instruction set also provides fully featured multifunction instructions that allow the programmer to use many of the processor core resources in a single instruction. Coupled with many features more often seen on microcontrollers, this instruction set is very efficient when compiling C and C++ source code. In addition, the architecture supports both user (algorithm/application code) and supervisor (O/S kernel, device drivers, debuggers, ISRs) modes of operation, allowing multiple levels of access to core processor resources.

The assembly language, which takes advantage of the processor's unique architecture, offers the following advantages:

- Seamlessly integrated DSP/MCU features are optimized for both 8-bit and 16-bit operations.
- A multi-issue load/store modified-Harvard architecture, which supports two 16-bit MAC or four 8-bit ALU + two load/store + two pointer updates per cycle.
- All registers, I/O, and memory are mapped into a unified 4G byte memory space, providing a simplified programming model.
- Microcontroller features, such as arbitrary bit and bit-field manipulation, insertion, and extraction; integer operations on 8-, 16-, and 32-bit data-types; and separate user and supervisor stack pointers.
- Code density enhancements, which include intermixing of 16-bit and 32-bit instructions (no mode switching, no code segregation). Frequently used instructions are encoded in 16 bits.

## DEVELOPMENT TOOLS

The processor is supported with a complete set of CROSSCORE® software and hardware development tools, including Analog Devices emulators and VisualDSP++® development environment. The same emulator hardware that supports other Blackfin processors also fully emulates the ADSP-BF52x processors.

### ***EZ-KIT Lite Evaluation Board***

For evaluation of ADSP-BF52x processors, use the EZ-KIT Lite® boards available from Analog Devices. Order using part numbers ADZS-BF526-EZLITE or ADZS-BF527-EZLITE. The boards come with on-chip emulation capabilities and are equipped to enable software development. Multiple daughter cards are available.

## DESIGNING AN EMULATOR-COMPATIBLE PROCESSOR BOARD (TARGET)

The Analog Devices family of emulators are tools that every system developer needs in order to test and debug hardware and software systems. Analog Devices has supplied an IEEE 1149.1

**Table 9. Fourth Byte for Large Page Devices**

Bit	Parameter	Value	Meaning
D1:D0	Page Size (excluding spare area)	00	1K byte
		01	2K byte
		10	4K byte
		11	8K byte
D2	Spare Area Size	00	8 byte/512 byte
		01	16 byte/512 byte
D5:D4	Block Size (excluding spare area)	00	64K byte
		01	128K byte
		10	256K byte
		11	512K byte
D6	Bus width	00	x8
		01	not supported
D3, D7	Not Used for configuration		

JTAG Test Access Port (TAP) on each JTAG processor. The emulator uses the TAP to access the internal features of the processor, allowing the developer to load code, set breakpoints, observe variables, observe memory, and examine registers. The processor must be halted to send data and commands, but once an operation has been completed by the emulator, the processor system is set running at full speed with no impact on system timing.

To use these emulators, the target board must include a header that connects the processor's JTAG port to the emulator.

For details on target board design issues including mechanical layout, single processor connections, multiprocessor scan chains, signal buffering, signal termination, and emulator pod logic, see (*EE-68 Analog Devices JTAG Emulation Technical Reference* on the Analog Devices website ([www.analog.com](http://www.analog.com)))—use site search on “EE-68.” This document is updated regularly to keep pace with improvements to emulator support.

## RELATED DOCUMENTS

The following publications that describe the ADSP-BF52x processors (and related processors) can be ordered from any Analog Devices sales office or accessed electronically on our website:

- *Getting Started With Blackfin Processors*
- *ADSP-BF52x Blackfin Processor Hardware Reference* (volumes 1 and 2)
- *Blackfin Processor Programming Reference*
- *ADSP-BF522/ADSP-BF524/ADSP-BF526 Blackfin Processor Anomaly List*
- *ADSP-BF523/ADSP-BF525/ADSP-BF527 Blackfin Processor Anomaly List*

## RELATED SIGNAL CHAINS

A *signal chain* is a series of signal-conditioning electronic components that receive input (data acquired from sampling either real-time phenomena or from stored data) in tandem, with the output of one portion of the chain supplying input to the next. Signal chains are often used in signal processing applications to gather and process data or to apply system controls based on analysis of real-time phenomena. For more information about this term and related topics, see the “signal chain” entry in [Wikipedia](#) or the [Glossary of EE Terms](#) on the Analog Devices website.

Analog Devices eases signal processing system development by providing signal processing components that are designed to work together well. A tool for viewing relationships between specific applications and related components is available on the [www.analog.com](http://www.analog.com) website.

The Application Signal Chains page in the Circuits from the Lab™ site (<http://www.analog.com/signalchains>) provides:

- Graphical circuit block diagram presentation of signal chains for a variety of circuit types and applications
- Drill down links for components in each chain to selection guides and application information
- Reference designs applying best practice design techniques

## LOCKBOX SECURE TECHNOLOGY DISCLAIMER

Analog Devices products containing Lockbox Secure Technology are warranted by Analog Devices as detailed in the Analog Devices Standard Terms and Conditions of Sale. To our knowledge, the Lockbox Secure Technology, when used in accordance with the data sheet and hardware reference manual specifications, provides a secure method of implementing code and data safeguards. However, Analog Devices does not guarantee that this technology provides absolute security.

ACCORDINGLY, ANALOG DEVICES HEREBY DISCLAIMS ANY AND ALL EXPRESS AND IMPLIED WARRANTIES THAT THE LOCKBOX SECURE TECHNOLOGY CANNOT BE BREACHED, COMPROMISED, OR OTHERWISE CIRCUMVENTED AND IN NO EVENT SHALL ANALOG DEVICES BE LIABLE FOR ANY LOSS, DAMAGE, DESTRUCTION, OR RELEASE OF DATA, INFORMATION, PHYSICAL PROPERTY, OR INTELLECTUAL PROPERTY.

## SIGNAL DESCRIPTIONS

Signal definitions for the ADSP-BF52x processors are listed in [Table 10](#). In order to maintain maximum function and reduce package size and ball count, some balls have dual, multiplexed functions. In cases where ball function is reconfigurable, the default state is shown in plain text, while the alternate function is shown in italics.

All pins are three-stated during and immediately after reset, with the exception of the external memory interface, asynchronous and synchronous memory control, and the buffered XTAL output pin (CLKBUF). On the external memory interface, the control and address lines are driven high, with the exception of CLKOUT, which toggles at the system clock rate. During hibernate, all outputs are three-stated unless otherwise noted in [Table 10](#).

All I/O pins have their input buffers disabled with the exception of the pins that need pull-ups or pull-downs, as noted in [Table 10](#).

It is strongly advised to use the available IBIS models to ensure that a given board design meets overshoot/undershoot and signal integrity requirements. If no IBIS simulation is performed, it is strongly recommended to add series resistor terminations for all Driver Types A, C and D.

The termination resistors should be placed near the processor to reduce transients and improve signal integrity. The resistance value, typically 33  $\Omega$  or 47  $\Omega$ , should be chosen to match the average board trace impedance.

Additionally, adding a parallel termination to CLKOUT may prove useful in further enhancing signal integrity. Be sure to verify overshoot/undershoot and signal integrity specifications on actual hardware.

**Table 10. Signal Descriptions**

Signal Name	Type	Function	Driver Type <sup>1</sup>
<i>EBIU</i>			
ADDR19-1	O	Address Bus	A
DATA15-0	I/O	Data Bus	A
<i>ABE1-0/SDQM1-0</i>	O	Byte Enables/ <i>Data Mask</i>	A
<i>AMS3-0</i>	O	Asynchronous Memory Bank Selects (Require pull-ups if hibernate is used.)	A
ARDY	I	Hardware Ready Control	
<i>AOE</i>	O	Asynchronous Output Enable	A
<i>ARE</i>	O	Asynchronous Read Enable	A
<i>AWE</i>	O	Asynchronous Write Enable	A
<i>SRA<math>\bar{S}</math></i>	O	SDRAM Row Address Strobe	A
<i>SCAS</i>	O	SDRAM Column Address Strobe	A
<i>SWE</i>	O	SDRAM Write Enable	A
SCKE	O	SDRAM Clock Enable (Requires a pull-down if hibernate with SDRAM self-refresh is used.)	A
CLKOUT	O	SDRAM Clock Output	B
SA10	O	SDRAM A10 Signal	A
<i>SMS</i>	O	SDRAM Bank Select	A

# ADSP-BF522/ADSP-BF523/ADSP-BF524/ADSP-BF525/ADSP-BF526/ADSP-BF527

**Table 10. Signal Descriptions (Continued)**

Signal Name	Type	Function	Driver Type <sup>1</sup>
<i>USB 2.0 HS OTG</i>			
USB_DP	I/O	Data + (This ball should be pulled low when USB is unused or not present.)	F
USB_DM	I/O	Data – (This ball should be pulled low when USB is unused or not present.)	F
USB_XI	I	USB Crystal Input (This ball should be pulled low when USB is unused or not present.)	
USB_XO	O	USB Crystal Output (This ball should be left unconnected when USB is unused or not present.)	F
USB_ID	I	USB OTG mode (This ball should be pulled low when USB is unused or not present.)	
USB_VREF	A	USB voltage reference (Connect to GND through a 0.1 μF capacitor or leave unconnected when not used.)	
USB_RSET	A	USB resistance set. (This ball should be left unconnected.)	
USB_VBUS	I/O 5V	USB VBUS. USB_VBUS is an output only in peripheral mode during SRP signaling. Host mode requires that an external voltage source of 5 V at 8 mA or more (per the OTG specification) be applied to VBUS. The voltage source needs to be able to charge and discharge VBUS, thus an ON/OFF switch is required to control the voltage source. A GPIO can be used for this purpose (This ball should be pulled low when USB is unused or not present.)	F
<i>Port F: GPIO and Multiplexed Peripherals</i>			
PF0/PPI D0/DR0PRI/ND_D0A	I/O	GPIO/PPI Data 0/SPORT0 Primary Receive Data /NAND Alternate Data 0	C
PF1/PPI D1/RFS0/ND_D1A	I/O	GPIO/PPI Data 1/SPORT0 Receive Frame Sync /NAND Alternate Data 1	C
PF2/PPI D2/RSCLK0/ND_D2A	I/O	GPIO/PPI Data 2/SPORT0 Receive Serial Clock /NAND Alternate Data 2/Alternate Capture Input 0	D
PF3/PPI D3/DT0PRI/ND_D3A	I/O	GPIO/PPI Data 3/SPORT0 Transmit Primary Data /NAND Alternate Data 3	C
PF4/PPI D4/TFS0/ND_D4A/TACKL0	I/O	GPIO/PPI Data 4/SPORT0 Transmit Frame Sync /NAND Alternate Data 4/Alternate Timer Clock 0	C
PF5/PPI D5/TSCLK0/ND_D5A/TACKL1	I/O	GPIO/PPI Data 5/SPORT0 Transmit Serial Clock /NAND Alternate Data 5/Alternate Timer Clock 1	D
PF6/PPI D6/DT0SEC/ND_D6A/TACI0	I/O	GPIO/PPI Data 6/SPORT0 Transmit Secondary Data /NAND Alternate Data 6/Alternate Capture Input 0	C
PF7/PPI D7/DR0SEC/ND_D7A/TACI1	I/O	GPIO/PPI Data 7/SPORT0 Receive Secondary Data /NAND Alternate Data 7/Alternate Capture Input 1	C
PF8/PPI D8/DR1PRI	I/O	GPIO/PPI Data 8/SPORT1 Primary Receive Data	C
PF9/PPI D9/RSCLK1/ <u>SPISEL6</u>	I/O	GPIO/PPI Data 9/SPORT1 Receive Serial Clock/SPI Slave Select 6	D
PF10/PPI D10/RFS1/ <u>SPISEL7</u>	I/O	GPIO/PPI Data 10/SPORT1 Receive Frame Sync/SPI Slave Select 7	C
PF11/PPI D11/TFS1/CZM	I/O	GPIO/PPI Data 11/SPORT1 Transmit Frame Sync/Counter Zero Marker	C
PF12/PPI D12/DT1PRI/ <u>SPISEL2</u> /CDG	I/O	GPIO/PPI Data 12/SPORT1 Transmit Primary Data/SPI Slave Select 2/Counter Down Gate	C
PF13/PPI D13/TSCLK1/ <u>SPISEL3</u> /CUD	I/O	GPIO/PPI Data 13/SPORT1 Transmit Serial Clock/SPI Slave Select 3/Counter Up Direction	D
PF14/PPI D14/DT1SEC/UART1TX	I/O	GPIO/PPI Data 14/SPORT1 Transmit Secondary Data/UART1 Transmit	C
PF15/PPI D15/DR1SEC/UART1RX/TACI3	I/O	GPIO/PPI Data 15/SPORT1 Receive Secondary Data /UART1 Receive /Alternate Capture Input 3	C

# ADSP-BF522/ADSP-BF523/ADSP-BF524/ADSP-BF525/ADSP-BF526/ADSP-BF527

**Table 10. Signal Descriptions (Continued)**

Signal Name	Type	Function	Driver Type <sup>1</sup>
<i>Port G: GPIO and Multiplexed Peripherals</i>			
PG0/HWAIT	I/O	GPIO/Boot Host Wait <sup>2</sup>	C
PG1/ <u>SPISS</u> /SPISEL1	I/O	GPIO/SPI Slave Select Input/SPI Slave Select 1	C
PG2/SCK	I/O	GPIO/SPI Clock	D
PG3/MISO/DR0SECA	I/O	GPIO/SPI Master In Slave Out/Sport 0 Alternate Receive Data Secondary	C
PG4/MOSI/DT0SECA	I/O	GPIO/SPI Master Out Slave In/Sport 0 Alternate Transmit Data Secondary	C
PG5/TMR1/PPI_FS2	I/O	GPIO/Timer1/PPI Frame Sync2	C
PG6/DT0PRIA/TMR2/PPI_FS3	I/O	GPIO/SPORT0 Alternate Primary Transmit Data / Timer2 / PPI Frame Sync3	C
PG7/TMR3/DR0PRIA/UART0TX	I/O	GPIO/Timer3/Sport 0 Alternate Receive Data Primary/UART0 Transmit	C
PG8/TMR4/RFS0A/UART0RX/TACI4	I/O	GPIO/Timer 4/Sport 0 Alternate Receive Clock/Frame Sync /UART0 Receive/Alternate Capture Input 4	C
PG9/TMR5/RSCLK0A/TACI5	I/O	GPIO/Timer5/Sport 0 Alternate Receive Clock /Alternate Capture Input 5	D
PG10/TMR6/TSCLK0A/TACI6	I/O	GPIO/Timer 6 /Sport 0 Alternate Transmit /Alternate Capture Input 6	D
PG11/TMR7/ <u>HOST_WR</u>	I/O	GPIO/Timer7/Host DMA Write Enable	C
PG12/DMAR1/UART1TXA/HOST_ACK	I/O	GPIO/DMA Request 1/Alternate UART1 Transmit/Host DMA Acknowledge	C
PG13/DMAR0/UART1RXA/HOST_ADDR/TACI2	I/O	GPIO/DMA Request 0/Alternate UART1 Receive/Host DMA Address/Alternate Capture Input 2	C
PG14/TSCLK0A1/MDC/ <u>HOST_RD</u>	I/O	GPIO/SPORT0 Alternate 1 Transmit/Ethernet Management Channel Clock /Host DMA Read Enable	D
PG15 <sup>3</sup> /TFS0A/MII PHYINT/RMII MDINT/ <u>HOST_CE</u>	I/O	GPIO/SPORT0 Alternate Transmit Frame Sync/Ethernet/MII PHY Interrupt/RMII Management Channel Data Interrupt/Host DMA Chip Enable	C
<i>Port H: GPIO and Multiplexed Peripherals</i>			
PH0/ND_D0/MII CRS/RMIICRS/DV/HOST_D0	I/O	GPIO/NAND D0/Ethernet MII or RMII Carrier Sense/Host DMA D0	C
PH1/ND_D1/ERxER/HOST_D1	I/O	GPIO/NAND D1/Ethernet MII or RMII Receive Error/Host DMA D1	C
PH2/ND_D2/MDIO/HOST_D2	I/O	GPIO/NAND D2/Ethernet Management Channel Serial Data/Host DMA D2	C
PH3/ND_D3/ETxEN/HOST_D3	I/O	GPIO/NAND D3/Ethernet MII Transmit Enable/Host DMA D3	C
PH4/ND_D4/MIIxCLK/RMIIREF_CLK/HOST_D4	I/O	GPIO/NAND D4/Ethernet MII or RMII Reference Clock/Host D4	C
PH5/ND_D5/ETxD0/HOST_D5	I/O	GPIO/NAND D5/Ethernet MII or RMII Transmit D0/Host DMA D5	C
PH6/ND_D6/ERxD0/HOST_D6	I/O	GPIO/NAND D6/Ethernet MII or RMII Receive D0/Host DMA D6	C
PH7/ND_D7/ETxD1/HOST_D7	I/O	GPIO/NAND D7/Ethernet MII or RMII Transmit D1/Host DMA D7	C
PH8/ <u>SPISEL4</u> /ERxD1/HOST_D8/TACLK2	I/O	GPIO/Alternate Timer Clock 2/Ethernet MII or RMII Receive D1/Host DMA D8 /SPI Slave Select 4	C
PH9/ <u>SPISEL5</u> /ETxD2/HOST_D9/TACLK3	I/O	GPIO/SPI Slave Select 5/Ethernet MII Transmit D2/Host DMA D9 /Alternate Timer Clock 3	C
PH10/ <u>ND_CE</u> /ERxD2/HOST_D10	I/O	GPIO/NAND Chip Enable/Ethernet MII Receive D2/Host DMA D10	C
PH11/ <u>ND_WE</u> /ETxD3/HOST_D11	I/O	GPIO/NAND Write Enable/Ethernet MII Transmit D3/Host DMA D11	C
PH12/ <u>ND_RE</u> /ERxD3/HOST_D12	I/O	GPIO/NAND Read Enable/Ethernet MII Receive D3/Host DMA D12	C
PH13/ <u>ND_BUSY</u> /ERxCLK/HOST_D13	I/O	GPIO/NAND Busy/Ethernet MII Receive Clock/Host DMA D13	C
PH14/ND_CLE/ERxDV/HOST_D14	I/O	GPIO/NAND Command Latch Enable/Ethernet MII or RMII Receive Data Valid/Host DMA D14	C
PH15/ND_ALE/COL/HOST_D15	I/O	GPIO/NAND Address Latch Enable/Ethernet MII Collision/Host DMA Data 15	C



# ADSP-BF522/ADSP-BF523/ADSP-BF524/ADSP-BF525/ADSP-BF526/ADSP-BF527

**Table 10. Signal Descriptions (Continued)**

Signal Name	Type	Function	Driver Type <sup>1</sup>
<i>Port J: Multiplexed Peripherals</i>			
PJ0: PPI_FS1/TMR0	I/O	PPI Frame Sync1/Timer0	C
PJ1: PPI_CLK/TMRCLK	I	PPI Clock/Timer Clock	
PJ2: SCL	I/O 5V	TWI Serial Clock (This pin is an open-drain output and requires a pull-up resistor. <sup>4</sup> )	E
PJ3: SDA	I/O 5V	TWI Serial Data (This pin is an open-drain output and requires a pull-up resistor. <sup>4</sup> )	E
<i>Real Time Clock</i>			
RTXI	I	RTC Crystal Input (This ball should be pulled low when not used.)	
RTXO	O	RTC Crystal Output (Does not three-state during hibernate.)	
<i>JTAG Port</i>			
TCK	I	JTAG Clock	
TDO	O	JTAG Serial Data Out	C
TDI	I	JTAG Serial Data In	
TMS	I	JTAG Mode Select	
$\overline{\text{TRST}}$	I	JTAG Reset (This ball should be pulled low if the JTAG port is not used.)	
$\overline{\text{EMU}}$	O	Emulation Output	C
<i>Clock</i>			
CLKIN	I	Clock/Crystal Input	
XTAL	O	Crystal Output (If CLKBUF is enabled, does not three-state during hibernate.)	
CLKBUF	O	Buffered XTAL Output (If enabled, does not three-state during hibernate.)	C
<i>Mode Controls</i>			
$\overline{\text{RESET}}$	I	Reset	
$\overline{\text{NMI}}$	I	Nonmaskable Interrupt (This ball should be pulled high when not used.)	
BMODE3-0	I	Boot Mode Strap 3-0	
<i>ADSP-BF523/ADSP-BF525/ADSP-BF527 Voltage Regulation I/F</i>			
VR <sub>SEL</sub>	I	Internal/External Voltage Regulator Select	
VR <sub>OUT</sub> /EXT_WAKE1	O	External FET Drive/Wake up Indication 1 (Does not three-state during hibernate.)	G
EXT_WAKE0	O	Wake up Indication 0 (Does not three-state during hibernate.)	C
SS/ $\overline{\text{PG}}$	A	Soft Start/Power Good	
<i>ADSP-BF522/ADSP-BF524/ADSP-BF526 Voltage Regulation I/F</i>			
EXT_WAKE1	O	Wake up Indication 1 (Does not three-state during hibernate.)	C
EXT_WAKE0	O	Wake up Indication 0 (Does not three-state during hibernate.)	C
$\overline{\text{PG}}$	A	Power Good (This signal should be pulled low when not used.)	

# ADSP-BF522/ADSP-BF523/ADSP-BF524/ADSP-BF525/ADSP-BF526/ADSP-BF527

**Table 10. Signal Descriptions (Continued)**

Signal Name	Type	Function	Driver Type <sup>1</sup>
<i>Power Supplies</i>		<b>ALL SUPPLIES MUST BE POWERED</b> See <a href="#">Operating Conditions for ADSP-BF523/ADSP-BF525/ADSP-BF527 Processors on Page 29</a> , and see <a href="#">Operating Conditions for ADSP-BF522/ADSP-BF524/ADSP-BF526 Processors on Page 27</a> .	
V <sub>DDEXT</sub>	P	I/O Power Supply	
V <sub>DDINT</sub>	P	Internal Power Supply	
V <sub>DDRTC</sub>	P	Real Time Clock Power Supply	
V <sub>DDUSB</sub>	P	3.3 V USB Phy Power Supply	
V <sub>DDMEM</sub>	P	MEM Power Supply	
V <sub>DDOTP</sub>	P	OTP Power Supply	
V <sub>PPOTP</sub>	P	OTP Programming Voltage	
GND	G	Ground for All Supplies	

<sup>1</sup> See [Output Drive Currents on Page 72](#) for more information about each driver type.

<sup>2</sup> HWAIT must be pulled high or low to configure polarity. It is driven as an output and toggle during processor boot. See [Booting Modes on Page 18](#).

<sup>3</sup> When driven low, this ball can be used to wake up the processor from the hibernate state, either in normal GPIO mode or in Ethernet mode as MII PHYINT. If the ball is used for wake up, enable the feature with the PHYWE bit in the VR\_CTL register, and pull-up the ball with a resistor.

<sup>4</sup> Consult version 2.1 of the I<sup>2</sup>C specification for the proper resistor value.

# ADSP-BF522/ADSP-BF523/ADSP-BF524/ADSP-BF525/ADSP-BF526/ADSP-BF527

## SPECIFICATIONS

Specifications are subject to change without notice.

### OPERATING CONDITIONS FOR ADSP-BF522/ADSP-BF524/ADSP-BF526 PROCESSORS

Parameter	Conditions	Min	Nominal	Max	Unit
V <sub>DDINT</sub>	Internal Supply Voltage	1.235		1.47	V
V <sub>DDEXT</sub>	External Supply Voltage <sup>1</sup>	1.7	1.8	1.9	V
V <sub>DDEXT</sub>	External Supply Voltage <sup>1</sup>	2.25	2.5	2.75	V
V <sub>DDEXT</sub>	External Supply Voltage <sup>1</sup>	3	3.3	3.6	V
V <sub>DDRTC</sub>	RTC Power Supply Voltage <sup>2</sup>	2.25		3.6	V
V <sub>DDMEM</sub>	MEM Supply Voltage <sup>1, 3</sup>	1.7	1.8	1.9	V
V <sub>DDMEM</sub>	MEM Supply Voltage <sup>1, 3</sup>	2.25	2.5	2.75	V
V <sub>DDMEM</sub>	MEM Supply Voltage <sup>1, 3</sup>	3	3.3	3.6	V
V <sub>DDOTP</sub>	OTP Supply Voltage <sup>1</sup>	2.25	2.5	2.75	V
V <sub>PPOTP</sub>	OTP Programming Voltage <sup>1</sup>				
	For Reads	2.25	2.5	2.75	V
	For Writes <sup>4</sup>	6.9	7.0	7.1	V
V <sub>DDUSB</sub>	USB Supply Voltage <sup>5</sup>	3.0	3.3	3.6	V
V <sub>IH</sub>	High Level Input Voltage <sup>6,7</sup>	V <sub>DDEXT</sub> /V <sub>DDMEM</sub> = 1.90 V	1.1		V
V <sub>IH</sub>	High Level Input Voltage <sup>6,7</sup>	V <sub>DDEXT</sub> /V <sub>DDMEM</sub> = 2.75 V	1.7		V
V <sub>IH</sub>	High Level Input Voltage <sup>6,7</sup>	V <sub>DDEXT</sub> /V <sub>DDMEM</sub> = 3.6 V	2.0		V
V <sub>IHTWI</sub> <sup>8</sup>	High Level Input Voltage	V <sub>DDEXT</sub> = 1.90 V/2.75 V/3.6 V	0.7 × V <sub>BUSTWI</sub>	V <sub>BUSTWI</sub>	V
V <sub>IL</sub>	Low Level Input Voltage <sup>6,7</sup>	V <sub>DDEXT</sub> /V <sub>DDMEM</sub> = 1.7 V		0.6	V
V <sub>IL</sub>	Low Level Input Voltage <sup>6,7</sup>	V <sub>DDEXT</sub> /V <sub>DDMEM</sub> = 2.25 V		0.7	V
V <sub>IL</sub>	Low Level Input Voltage <sup>6,7</sup>	V <sub>DDEXT</sub> /V <sub>DDMEM</sub> = 3.0 V		0.8	V
V <sub>ILTWI</sub>	Low Level Input Voltage	V <sub>DDEXT</sub> = Minimum		0.3 × V <sub>BUSTWI</sub> <sup>9</sup>	V
T <sub>J</sub>	Junction Temperature	289-Ball CSP_BGA @ T <sub>AMBIENT</sub> = 0°C to +70°C	0	+105	°C
T <sub>J</sub>	Junction Temperature	208-Ball CSP_BGA @ T <sub>AMBIENT</sub> = 0°C to +70°C	0	+105	°C
T <sub>J</sub>	Junction Temperature	208-Ball CSP_BGA @ T <sub>AMBIENT</sub> = -40°C to +85°C	-40	+105	°C

<sup>1</sup> Must remain powered (even if the associated function is not used).

<sup>2</sup> If not used, power with V<sub>DDEXT</sub>.

<sup>3</sup> Balls that use V<sub>DDMEM</sub> are DATA15-0, ADDR19-1, ABE1-0, ARE, AWE, AOE, AMS3-0, ARDY, SA10, SWE, SCAS, CLKOUT, SRAS, SMS, SCKE. These balls are not tolerant to voltages higher than V<sub>DDMEM</sub>.

<sup>4</sup> The V<sub>PPOTP</sub> voltage for writes must only be applied when programming OTP memory. There is a finite amount of cumulative time that this voltage may be applied (dependent on voltage and junction temperature) over the lifetime of the part. Please see Table 30 on Page 37 for details.

<sup>5</sup> When not using the USB peripheral on the ADSP-BF524/ADSP-BF526 or terminating V<sub>DDUSB</sub> on the ADSP-BF522, V<sub>DDUSB</sub> must be powered by V<sub>DDEXT</sub>.

<sup>6</sup> Bidirectional balls (PF15-0, PG15-0, PH15-0) and input balls (RTXI, TCK, TDI, TMS, TRST, CLKIN, RESET, NMI, and BMODE3-0) of the ADSP-BF52x processors are 3.3 V tolerant (always accept up to 3.6 V maximum V<sub>IH</sub>). Voltage compliance (on outputs, V<sub>OH</sub>) is limited by the V<sub>DDEXT</sub> supply voltage.

<sup>7</sup> Parameter value applies to all input and bidirectional balls, except USB\_DP, USB\_DM, USB\_VBUS, SDA, and SCL.

<sup>8</sup> The V<sub>IHTWI</sub> min and max value vary with the selection in the TWI\_DT field of the NONGPIO\_DRIVE register. See V<sub>BUSTWI</sub> min and max values in Table 11.

<sup>9</sup> SDA and SCL are pulled up to V<sub>BUSTWI</sub>. See Table 11.

# ADSP-BF522/ADSP-BF523/ADSP-BF524/ADSP-BF525/ADSP-BF526/ADSP-BF527

Table 11 shows settings for TWI\_DT in the NONGPIO\_DRIVE register. Set this register prior to using the TWI port.

**Table 11. TWI\_DT Field Selections and  $V_{DDEXT}/V_{BUSTWI}$**

TWI_DT	$V_{DDEXT}$ Nominal	$V_{BUSTWI}$ Min	$V_{BUSTWI}$ Nominal	$V_{BUSTWI}$ Max	Unit
000 (default) <sup>1</sup>	3.3	2.97	3.3	3.63	V
001	1.8	1.7	1.8	1.98	V
010	2.5	2.97	3.3	3.63	V
011	1.8	2.97	3.3	3.63	V
100	3.3	4.5	5	5.5	V
101	1.8	2.25	2.5	2.75	V
110	2.5	2.25	2.5	2.75	V
111 (reserved)	–	–	–	–	–

<sup>1</sup> Designs must comply with the  $V_{DDEXT}$  and  $V_{BUSTWI}$  voltages specified for the default TWI\_DT setting for correct JTAG boundary scan operation during reset.

## Clock Related Operating Conditions for ADSP-BF522/ADSP-BF524/ADSP-BF526 Processors

Table 12 describes the core clock timing requirements for the ADSP-BF522/ADSP-BF524/ADSP-BF526 processors. Take care in selecting MSEL, SSEL, and CSEL ratios so as not to exceed the maximum core clock and system clock (see Table 14). Table 13 describes phase-locked loop operating conditions.

**Table 12. Core Clock (CCLK) Requirements (All Instruction Rates<sup>1</sup>) for ADSP-BF522/ADSP-BF524/ADSP-BF526 Processors**

Parameter	Nominal Voltage Setting	Max	Unit
$f_{CCLK}$ Core Clock Frequency ( $V_{DDINT} = 1.33$ V minimum)	1.40 V	400 <sup>2</sup>	MHz
$f_{CCLK}$ Core Clock Frequency ( $V_{DDINT} = 1.235$ V minimum)	1.30 V	300	MHz

<sup>1</sup> See the Ordering Guide on Page 87.

<sup>2</sup> Applies to 400 MHz models only. See the Ordering Guide on Page 87.

**Table 13. Phase-Locked Loop Operating Conditions for ADSP-BF522/ADSP-BF524/ADSP-BF526 Processors**

Parameter	Min	Max	Unit
$f_{VCO}$ Voltage Controlled Oscillator (VCO) Frequency	70	Instruction Rate <sup>1</sup>	MHz

<sup>1</sup> See the Ordering Guide on Page 87.

**Table 14. SCLK Conditions for ADSP-BF522/ADSP-BF524/ADSP-BF526 Processors**

Parameter		$V_{DDEXT}/V_{DDMEM}$ 1.8 V Nominal <sup>1</sup>	$V_{DDEXT}/V_{DDMEM}$ 2.5 V or 3.3 V Nominal	Unit
		Max	Max	
$f_{SCLK}$	CLKOUT/SCLK Frequency ( $V_{DDINT} \geq 1.33$ V) <sup>2</sup>	80	100	MHz
$f_{SCLK}$	CLKOUT/SCLK Frequency ( $V_{DDINT} < 1.33$ V)	80	80	MHz

<sup>1</sup> If either  $V_{DDEXT}$  or  $V_{DDMEM}$  are operating at 1.8V nominal,  $f_{SCLK}$  is constrained to 80 MHz.

<sup>2</sup>  $f_{SCLK}$  must be less than or equal to  $f_{CCLK}$  and is subject to additional restrictions for SDRAM interface operation. See Table 37 on Page 46.

# ADSP-BF522/ADSP-BF523/ADSP-BF524/ADSP-BF525/ADSP-BF526/ADSP-BF527

## OPERATING CONDITIONS FOR ADSP-BF523/ADSP-BF525/ADSP-BF527 PROCESSORS

Parameter	Conditions	Min	Nominal	Max	Unit
V <sub>DDINT</sub>	Internal Supply Voltage <sup>1</sup>	Nonautomotive models <sup>2</sup>		1.26	V
V <sub>DDINT</sub>	Internal Supply Voltage <sup>1</sup>	Automotive 533 MHz models <sup>3</sup>	1.093	1.26	V
V <sub>DDINT</sub>	Internal Supply Voltage <sup>1</sup>	Automotive 400 MHz models <sup>3</sup>	1.045	1.20	V
V <sub>DDEXT</sub>	External Supply Voltage <sup>4,5</sup>	Nonautomotive models, Internal Voltage Regulator Disabled	1.7	1.9	V
V <sub>DDEXT</sub>	External Supply Voltage <sup>4,5</sup>	Nonautomotive models	2.25	2.75	V
V <sub>DDEXT</sub>	External Supply Voltage <sup>4,5</sup>	Nonautomotive models	3	3.6	V
V <sub>DDEXT</sub>	External Supply Voltage <sup>4,5</sup>	Automotive models	2.7	3.6	V
V <sub>DDRTC</sub>	RTC Power Supply Voltage <sup>6</sup>	Nonautomotive models	2.25	3.6	V
V <sub>DDRTC</sub>	RTC Power Supply Voltage <sup>6</sup>	Automotive models	2.7	3.6	V
V <sub>DDMEM</sub>	MEM Supply Voltage <sup>4,7</sup>	Nonautomotive models	1.7	1.9	V
V <sub>DDMEM</sub>	MEM Supply Voltage <sup>4,7</sup>	Nonautomotive models	2.25	2.75	V
V <sub>DDMEM</sub>	MEM Supply Voltage <sup>4,7</sup>	Nonautomotive models	3	3.6	V
V <sub>DDMEM</sub>	MEM Supply Voltage <sup>4,7</sup>	Automotive models	2.7	3.6	V
V <sub>DDOTP</sub>	OTP Supply Voltage <sup>4</sup>		2.25	2.75	V
V <sub>PPOTP</sub>	OTP Programming Voltage <sup>4</sup>		2.25	2.75	V
V <sub>DDUSB</sub>	USB Supply Voltage <sup>8</sup>		3.0	3.6	V
V <sub>IH</sub>	High Level Input Voltage <sup>9,10</sup>	V <sub>DDEXT</sub> /V <sub>DDMEM</sub> = 1.90 V	1.1		V
V <sub>IH</sub>	High Level Input Voltage <sup>9,10</sup>	V <sub>DDEXT</sub> /V <sub>DDMEM</sub> = 2.75 V	1.7		V
V <sub>IH</sub>	High Level Input Voltage <sup>9,10</sup>	V <sub>DDEXT</sub> /V <sub>DDMEM</sub> = 3.6 V	2.0		V
V <sub>IHTWI</sub> <sup>11</sup>	High Level Input Voltage	V <sub>DDEXT</sub> = 1.90 V/2.75 V/3.6 V	0.7 × V <sub>BUSTWI</sub>	V <sub>BUSTWI</sub>	V
V <sub>IL</sub>	Low Level Input Voltage <sup>9,10</sup>	V <sub>DDEXT</sub> /V <sub>DDMEM</sub> = 1.7 V		0.6	V
V <sub>IL</sub>	Low Level Input Voltage <sup>9,10</sup>	V <sub>DDEXT</sub> /V <sub>DDMEM</sub> = 2.25 V		0.7	V
V <sub>IL</sub>	Low Level Input Voltage <sup>9,10</sup>	V <sub>DDEXT</sub> /V <sub>DDMEM</sub> = 3.0 V		0.8	V
V <sub>ILTWI</sub>	Low Level Input Voltage	V <sub>DDEXT</sub> = Minimum		0.3 × V <sub>BUSTWI</sub> <sup>12</sup>	V
T <sub>J</sub>	Junction Temperature	289-Ball CSP_BGA @ T <sub>AMBIENT</sub> = 0°C to +70°C	0	+105	°C
T <sub>J</sub>	Junction Temperature	289-Ball CSP_BGA @ T <sub>AMBIENT</sub> = -40°C to +70°C	-40	+105	°C
T <sub>J</sub>	Junction Temperature	208-Ball CSP_BGA @ T <sub>AMBIENT</sub> = 0°C to +70°C	0	+105	°C
T <sub>J</sub>	Junction Temperature	208-Ball CSP_BGA @ T <sub>AMBIENT</sub> = -40°C to +85°C	-40	+105	°C

<sup>1</sup> The voltage regulator can generate V<sub>DDINT</sub> at levels of 1.00 V to 1.20 V with -5% to +5% tolerance when VRCTL is programmed with the bfrom\_SysControl() API. This specification is only guaranteed when the API is used.

<sup>2</sup> See [Ordering Guide on Page 87](#).

<sup>3</sup> See [Automotive Products on Page 86](#).

<sup>4</sup> Must remain powered (even if the associated function is not used).

<sup>5</sup> V<sub>DDEXT</sub> is the supply to the voltage regulator and GPIO.

<sup>6</sup> If not used, power with V<sub>DDEXT</sub>.

<sup>7</sup> Balls that use V<sub>DDMEM</sub> are DATA15-0, ADDR19-1, ABE1-0, ARE, AWE, AOE, AMS3-0, ARDY, SA10, SWE, SCAS, CLKOUT, SRAS, SMS, SCKE. These balls are not tolerant to voltages higher than V<sub>DDMEM</sub>.

<sup>8</sup> When not using the USB peripheral on the ADSP-BF525/ADSP-BF527 or terminating V<sub>DDUSB</sub> on the ADSP-BF523, V<sub>DDUSB</sub> must be powered by V<sub>DDEXT</sub>.

<sup>9</sup> Bidirectional balls (PF15-0, PG15-0, PH15-0) and input balls (RTXI, TCK, TDI, TMS, TRST, CLKIN, RESET, NMI, and BMODE3-0) of the ADSP-BF52x processors are 3.3 V tolerant (always accept up to 3.6 V maximum V<sub>IH</sub>). Voltage compliance (on outputs, V<sub>OH</sub>) is limited by the V<sub>DDEXT</sub> supply voltage.

<sup>10</sup> Parameter value applies to all input and bidirectional balls, except USB\_DP, USB\_DM, USB\_VBUS, SDA, and SCL.

<sup>11</sup> The V<sub>IHTWI</sub> min and max value vary with the selection in the TWL\_DT field of the NONGPIO\_DRIVE register. See V<sub>BUSTWI</sub> min and max values in [Table 11 on Page 28](#).

<sup>12</sup> SDA and SCL are pulled up to V<sub>BUSTWI</sub>. See [Table 11 on Page 28](#).

# ADSP-BF522/ADSP-BF523/ADSP-BF524/ADSP-BF525/ADSP-BF526/ADSP-BF527

## Clock Related Operating Conditions for ADSP-BF523/ADSP-BF525/ADSP-BF527 Processors

Table 15 describes the core clock timing requirements for the ADSP-BF523/ADSP-BF525/ADSP-BF527 processors. Take care in selecting MSEL, SSEL, and CSEL ratios so as not to exceed the maximum core clock and system clock (see Table 17). Table 16 describes phase-locked loop operating conditions.

Use the nominal voltage setting (Table 15) for internal and external regulators.

**Table 15. Core Clock (CCLK) Requirements (All Instruction Rates<sup>1</sup>) for ADSP-BF523/ADSP-BF525/ADSP-BF527 Processors**

Parameter		Nominal Voltage Setting	Max	Unit
f <sub>CCLK</sub>	Core Clock Frequency (V <sub>DDINT</sub> = 1.14 V minimum)	1.20 V	600 <sup>2</sup>	MHz
f <sub>CCLK</sub>	Core Clock Frequency (V <sub>DDINT</sub> = 1.093 V minimum)	1.15 V	533 <sup>3</sup>	MHz
f <sub>CCLK</sub>	Core Clock Frequency (V <sub>DDINT</sub> = 1.045 V minimum) <sup>4</sup>	1.10 V	400	MHz
f <sub>CCLK</sub>	Core Clock Frequency (V <sub>DDINT</sub> = 0.95 V minimum)	1.0 V	400	MHz

<sup>1</sup> See the Ordering Guide on Page 87.

<sup>2</sup> Applies to 600 MHz models only. See the Ordering Guide on Page 87.

<sup>3</sup> Applies to 533 MHz and 600 MHz models only. See the Ordering Guide on Page 87.

<sup>4</sup> Applies only to automotive products. See Automotive Products on Page 86.

**Table 16. Phase-Locked Loop Operating Conditions for ADSP-BF523/ADSP-BF525/ADSP-BF527 Processors**

Parameter		Min	Max	Unit
f <sub>VCO</sub>	Voltage Controlled Oscillator (VCO) Frequency (Commercial/Industrial Models)	60	Instruction Rate <sup>1</sup>	MHz
f <sub>VCO</sub>	Voltage Controlled Oscillator (VCO) Frequency (Automotive Models)	70	Instruction Rate <sup>1</sup>	MHz

<sup>1</sup> See the Ordering Guide on Page 87.

**Table 17. SCLK Conditions for ADSP-BF523/ADSP-BF525/ADSP-BF527 Processors**

Parameter		V <sub>DDEXT</sub> /V <sub>DDMEM</sub> 1.8 V Nominal <sup>1</sup>	V <sub>DDEXT</sub> /V <sub>DDMEM</sub> 2.5 V or 3.3 V Nominal	Unit
		Max	Max	
f <sub>SCLK</sub>	CLKOUT/SCLK Frequency (V <sub>DDINT</sub> ≥ 1.14 V) <sup>2</sup>	100	133 <sup>3</sup>	MHz
f <sub>SCLK</sub>	CLKOUT/SCLK Frequency (V <sub>DDINT</sub> < 1.14 V) <sup>2</sup>	100	100	MHz

<sup>1</sup> If either V<sub>DDEXT</sub> or V<sub>DDMEM</sub> are operating at 1.8V nominal, f<sub>SCLK</sub> is constrained to 100 MHz.

<sup>2</sup> f<sub>SCLK</sub> must be less than or equal to f<sub>CCLK</sub> and is subject to additional restrictions for SDRAM interface operation. See Table 38 on Page 46.

<sup>3</sup> Rounded number. Actual test specification is SCLK period of 7.5 ns. See Table 38 on Page 46.

# ADSP-BF522/ADSP-BF523/ADSP-BF524/ADSP-BF525/ADSP-BF526/ADSP-BF527

## ELECTRICAL CHARACTERISTICS

Table 18. Common Electrical Characteristics for All ADSP-BF52x Processors

Parameter	Test Conditions	Min	Typical	Max	Unit
V <sub>OH</sub>	High Level Output Voltage V <sub>DDEXT</sub> /V <sub>DDMEM</sub> = 1.7 V, I <sub>OH</sub> = -0.5 mA	1.35			V
V <sub>OH</sub>	High Level Output Voltage V <sub>DDEXT</sub> /V <sub>DDMEM</sub> = 2.25 V, I <sub>OH</sub> = -0.5 mA	2.0			V
V <sub>OH</sub>	High Level Output Voltage V <sub>DDEXT</sub> /V <sub>DDMEM</sub> = 3.0 V, I <sub>OH</sub> = -0.5 mA	2.4			V
V <sub>OL</sub>	Low Level Output Voltage V <sub>DDEXT</sub> /V <sub>DDMEM</sub> = 1.7/2.25/3.0 V, I <sub>OL</sub> = 2.0 mA			0.4	V
I <sub>IH</sub>	High Level Input Current <sup>1</sup> V <sub>DDEXT</sub> /V <sub>DDMEM</sub> = 3.6 V, V <sub>IN</sub> = 3.6 V			10.0	μA
I <sub>IL</sub>	Low Level Input Current <sup>1</sup> V <sub>DDEXT</sub> /V <sub>DDMEM</sub> = 3.6 V, V <sub>IN</sub> = 0 V			10.0	μA
I <sub>IHP</sub>	High Level Input Current JTAG <sup>2</sup> V <sub>DDEXT</sub> = 3.6 V, V <sub>IN</sub> = 3.6 V			75.0	μA
I <sub>OZH</sub>	Three-State Leakage Current <sup>3</sup> V <sub>DDEXT</sub> /V <sub>DDMEM</sub> = 3.6 V, V <sub>IN</sub> = 3.6 V			10.0	μA
I <sub>OZHTWI</sub>	Three-State Leakage Current <sup>4</sup> V <sub>DDEXT</sub> = 3.0 V, V <sub>IN</sub> = 5.5 V			10.0	μA
I <sub>OZL</sub>	Three-State Leakage Current <sup>3</sup> V <sub>DDEXT</sub> /V <sub>DDMEM</sub> = 3.6 V, V <sub>IN</sub> = 0 V			10.0	μA
C <sub>IN</sub>	Input Capacitance <sup>5,6</sup> f <sub>IN</sub> = 1 MHz, T <sub>AMBIENT</sub> = 25°C, V <sub>IN</sub> = 2.5 V		5	8	pF
C <sub>INTWI</sub>	Input Capacitance <sup>4,6</sup> f <sub>IN</sub> = 1 MHz, T <sub>AMBIENT</sub> = 25°C, V <sub>IN</sub> = 2.5 V			15	pF

<sup>1</sup> Applies to input balls.

<sup>2</sup> Applies to JTAG input balls (TCK, TDI, TMS, TRST).

<sup>3</sup> Applies to three-statable balls.

<sup>4</sup> Applies to bidirectional balls SCL and SDA.

<sup>5</sup> Applies to all signal balls, except SCL and SDA.

<sup>6</sup> Guaranteed, but not tested.

# ADSP-BF522/ADSP-BF523/ADSP-BF524/ADSP-BF525/ADSP-BF526/ADSP-BF527

**Table 19. Electrical Characteristics for ADSP-BF522/ADSP-BF524/ADSP-BF526 Processors**

Parameter	Test Conditions	Min	Typical	Max	Unit
$I_{DDDEEPSLEEP}^1$	$V_{DDINT}$ Current in Deep Sleep Mode		2		mA
$I_{DDESLEEP}$	$V_{DDINT}$ Current in Sleep Mode		13		mA
$I_{DDIDLE}$	$V_{DDINT}$ Current in Idle		44		mA
$I_{DD-TYP}$	$V_{DDINT}$ Current		83		mA
$I_{DD-TYP}$	$V_{DDINT}$ Current		114		mA
$I_{DDHIBERNATE}^{1,2}$	Hibernate State Current		40		$\mu$ A
$I_{DDRTC}$	$V_{DDRTC}$ Current		20		$\mu$ A
$I_{DDUSB-FS}$	$V_{DDUSB}$ Current in Full/Low Speed Mode		9		mA
$I_{DDUSB-HS}$	$V_{DDUSB}$ Current in High Speed Mode		25		mA
$I_{DDESLEEP}^{1,3}$	$V_{DDINT}$ Current in Sleep Mode	$f_{CCLK} = 0$ MHz, $f_{SCLK} > 0$ MHz		Table 22 + $(0.52 \times V_{DDINT} \times f_{SCLK})^4$	mA <sup>4</sup>
$I_{DDDEEPSLEEP}^{1,3}$	$V_{DDINT}$ Current in Deep Sleep Mode	$f_{CCLK} = 0$ MHz, $f_{SCLK} = 0$ MHz		Table 22	mA
$I_{DDINT}^{3,5}$	$V_{DDINT}$ Current	$f_{CCLK} > 0$ MHz, $f_{SCLK} \geq 0$ MHz		Table 22 + $(Table\ 23 \times ASF) + (0.52 \times V_{DDINT} \times f_{SCLK})$	mA
$I_{DDOTP}$	$V_{DDOTP}$ Current	$V_{DDOTP} = 2.5$ V, $T_J = 25^\circ$ C, OTP Memory Read	2		mA
$I_{DDOTP}$	$V_{DDOTP}$ Current	$V_{DDOTP} = 2.5$ V, $T_J = 25^\circ$ C, OTP Memory Write	2		mA
$I_{PPOTP}$	$V_{PPOTP}$ Current	$V_{PPOTP} = 2.5$ V, $T_J = 25^\circ$ C, OTP Memory Read	100		$\mu$ A
$I_{PPOTP}$	$V_{PPOTP}$ Current	$V_{PPOTP} =$ see Table 30, $T_J = 25^\circ$ C, OTP Memory Write	3		mA

<sup>1</sup> See the ADSP-BF52x Blackfin Processor Hardware Reference Manual for definition of sleep, deep sleep, and hibernate operating modes.

<sup>2</sup> Includes current on  $V_{DDEXT}$ ,  $V_{DDUSB}$ ,  $V_{DDMEM}$ ,  $V_{DDOTP}$ , and  $V_{PPOTP}$  supplies. Clock inputs are tied high or low.

<sup>3</sup> Guaranteed maximum specifications.

<sup>4</sup> Unit for  $V_{DDINT}$  is V (Volts). Unit for  $f_{SCLK}$  is MHz. Example: 1.4 V, 75 MHz would be  $0.52 \times 1.4 \times 75$  MHz = 54.6 mA adder.

<sup>5</sup> See Table 21 for the list of  $I_{DDINT}$  power vectors covered.



# ADSP-BF522/ADSP-BF523/ADSP-BF524/ADSP-BF525/ADSP-BF526/ADSP-BF527

**Table 20. Electrical Characteristics for ADSP-BF523/ADSP-BF525/ADSP-BF527 Processors**

Parameter	Test Conditions	Min	Typical	Max	Unit
$I_{DDDEEPSLEEP}^1$	$V_{DDINT}$ Current in Deep Sleep Mode $V_{DDINT} = 1.0\text{ V}$ , $f_{CCLK} = 0\text{ MHz}$ , $f_{SCLK} = 0\text{ MHz}$ , $T_j = 25^\circ\text{C}$ , $ASF = 0.00$		10		mA
$I_{DDSLLEEP}$	$V_{DDINT}$ Current in Sleep Mode $V_{DDINT} = 1.0\text{ V}$ , $f_{SCLK} = 25\text{ MHz}$ , $T_j = 25^\circ\text{C}$		20		mA
$I_{DD-IDLE}$	$V_{DDINT}$ Current in Idle $V_{DDINT} = 1.0\text{ V}$ , $f_{CCLK} = 400\text{ MHz}$ , $f_{SCLK} = 25\text{ MHz}$ , $T_j = 25^\circ\text{C}$ , $ASF = 0.44$		53		mA
$I_{DD-TYP}$	$V_{DDINT}$ Current $V_{DDINT} = 1.0\text{ V}$ , $f_{CCLK} = 400\text{ MHz}$ , $f_{SCLK} = 25\text{ MHz}$ , $T_j = 25^\circ\text{C}$ , $ASF = 1.00$		94		mA
$I_{DD-TYP}$	$V_{DDINT}$ Current $V_{DDINT} = 1.15\text{ V}$ , $f_{CCLK} = 533\text{ MHz}$ , $f_{SCLK} = 25\text{ MHz}$ , $T_j = 25^\circ\text{C}$ , $ASF = 1.00$		144		mA
$I_{DD-TYP}$	$V_{DDINT}$ Current $V_{DDINT} = 1.2\text{ V}$ , $f_{CCLK} = 600\text{ MHz}$ , $f_{SCLK} = 25\text{ MHz}$ , $T_j = 25^\circ\text{C}$ , $ASF = 1.00$		170		mA
$I_{DDHIBERNATE}^{1,2}$	Hibernate State Current $V_{DDEXT} = V_{DDMEM} = V_{DDRTC} = V_{DDUSB} = 3.30\text{ V}$ , $V_{DDOTP} = V_{PPOTP} = 2.5\text{ V}$ , $T_j = 25^\circ\text{C}$ , $CLKIN = 0\text{ MHz}$ with voltage regulator off ( $V_{DDINT} = 0\text{ V}$ )		40		$\mu\text{A}$
$I_{DDRTC}$	$V_{DDRTC}$ Current $V_{DDRTC} = 3.3\text{ V}$ , $T_j = 25^\circ\text{C}$		20		$\mu\text{A}$
$I_{DDUSB-FS}$	$V_{DDUSB}$ Current in Full/Low Speed Mode $V_{DDUSB} = 3.3\text{ V}$ , $T_j = 25^\circ\text{C}$ , Full Speed USB Transmit		9		mA
$I_{DDUSB-HS}$	$V_{DDUSB}$ Current in High Speed Mode $V_{DDUSB} = 3.3\text{ V}$ , $T_j = 25^\circ\text{C}$ , High Speed USB Transmit		25		mA
$I_{DDSLLEEP}^{1,3}$	$V_{DDINT}$ Current in Sleep Mode $f_{CCLK} = 0\text{ MHz}$ , $f_{SCLK} > 0\text{ MHz}$			Table 24 + $(0.61 \times V_{DDINT} \times f_{SCLK})^4$	mA <sup>4</sup>
$I_{DDDEEPSLEEP}^{1,3}$	$V_{DDINT}$ Current in Deep Sleep Mode $f_{CCLK} = 0\text{ MHz}$ , $f_{SCLK} = 0\text{ MHz}$			Table 24	mA
$I_{DDINT}^{3,5}$	$V_{DDINT}$ Current $f_{CCLK} > 0\text{ MHz}$ , $f_{SCLK} \geq 0\text{ MHz}$			Table 24 + (Table 25 $\times ASF$ ) + $(0.61 \times V_{DDINT} \times f_{SCLK})$	mA
$I_{DDOTP}$	$V_{DDOTP}$ Current $V_{DDOTP} = 2.5\text{ V}$ , $T_j = 25^\circ\text{C}$ , OTP Memory Read		1		mA
$I_{DDOTP}$	$V_{DDOTP}$ Current $V_{DDOTP} = 2.5\text{ V}$ , $T_j = 25^\circ\text{C}$ , OTP Memory Write		25		mA
$I_{PPOTP}$	$V_{PPOTP}$ Current $V_{PPOTP} = 2.5\text{ V}$ , $T_j = 25^\circ\text{C}$ , OTP Memory Read		0		mA
$I_{PPOTP}$	$V_{PPOTP}$ Current $V_{PPOTP} = 2.5\text{ V}$ , $T_j = 25^\circ\text{C}$ , OTP Memory Write		0		mA

<sup>1</sup> See the *ADSP-BF52x Blackfin Processor Hardware Reference Manual* for definition of sleep, deep sleep, and hibernate operating modes.

<sup>2</sup> Includes current on  $V_{DDEXT}$ ,  $V_{DDUSB}$ ,  $V_{DDMEM}$ ,  $V_{DDOTP}$ , and  $V_{PPOTP}$  supplies. Clock inputs are tied high or low.

<sup>3</sup> Guaranteed maximum specifications.

<sup>4</sup> Unit for  $V_{DDINT}$  is V (Volts). Unit for  $f_{SCLK}$  is MHz. Example:  $1.2\text{ V}$ ,  $75\text{ MHz}$  would be  $0.61 \times 1.2 \times 75 = 54.9\text{ mA}$  adder.

<sup>5</sup> See [Table 21](#) for the list of  $I_{DDINT}$  power vectors covered.

# ADSP-BF522/ADSP-BF523/ADSP-BF524/ADSP-BF525/ADSP-BF526/ADSP-BF527

## Total Power Dissipation

Total power dissipation has two components:

1. Static, including leakage current
2. Dynamic, due to transistor switching characteristics

Many operating conditions can also affect power dissipation, including temperature, voltage, operating frequency, and processor activity. [Electrical Characteristics on Page 31](#) shows the current dissipation for internal circuitry ( $V_{DDINT}$ ).  $I_{DDDEEPSLEEP}$  specifies static power dissipation as a function of voltage ( $V_{DDINT}$ ) and temperature (see [Table 22](#) or [Table 24](#)), and  $I_{DDINT}$  specifies the total power specification for the listed test conditions, including the dynamic component as a function of voltage ( $V_{DDINT}$ ) and frequency ([Table 23](#) or [Table 25](#)).

There are two parts to the dynamic component. The first part is due to transistor switching in the core clock (CCLK) domain. This part is subject to an Activity Scaling Factor (ASF) which represents application code running on the processor core and L1 memories ([Table 21](#)).

The ASF is combined with the CCLK Frequency and  $V_{DDINT}$  dependent data in [Table 23](#) or [Table 25](#) to calculate this part. The second part is due to transistor switching in the system clock (SCLK) domain, which is included in the  $I_{DDINT}$  specification equation.

**Table 21. Activity Scaling Factors (ASF)<sup>1</sup>**

$I_{DDINT}$ Power Vector	Activity Scaling Factor (ASF)
$I_{DD-PEAK}$	1.29
$I_{DD-HIGH}$	1.26
$I_{DD-TYP}$	1.00
$I_{DD-APP}$	0.88
$I_{DD-NOP}$	0.72
$I_{DD-IDLE}$	0.44

<sup>1</sup> See *Estimating Power for ADSP-BF534/BF536/BF537 Blackfin Processors (EE-297)*. The power vector information also applies to the ADSP-BF52x processors.

**Table 22. Static Current —  $I_{DD-DEEPSLEEP}$  (mA) for ADSP-BF522/ADSP-BF524/ADSP-BF526 Processors**

$T_J$ (°C) <sup>1</sup>	Voltage ( $V_{DDINT}$ ) <sup>1</sup>						
	1.2 V	1.25 V	1.3 V	1.35 V	1.4 V	1.45 V	1.5 V
-40	1.47	1.42	1.50	1.64	1.85	2.12	2.09
-20	1.67	1.81	1.89	1.95	2.01	2.07	2.12
0	1.97	2.07	2.15	2.22	2.30	2.39	2.47
25	2.49	2.66	2.79	2.92	3.07	3.20	3.36
40	3.12	3.37	3.57	3.75	3.96	4.18	4.40
55	4.07	4.47	4.82	5.11	5.41	5.73	6.06
70	5.77	6.28	6.71	7.17	7.61	8.09	8.60
85	8.32	8.88	9.56	10.25	10.94	11.63	12.36
100	12.11	12.93	13.94	14.76	15.76	16.77	17.83
105	13.78	14.72	15.74	16.81	17.91	19.06	20.27

<sup>1</sup> Valid temperature and voltage ranges are model-specific. See [Operating Conditions for ADSP-BF522/ADSP-BF524/ADSP-BF526 Processors on Page 27](#).

**Table 23. Dynamic Current in CCLK Domain (mA, with ASF = 1.0)<sup>1</sup> for ADSP-BF522/ADSP-BF524/ADSP-BF526 Processors**

$f_{CCLK}$ (MHz) <sup>2</sup>	Voltage ( $V_{DDINT}$ ) <sup>2</sup>						
	1.2 V	1.25 V	1.3 V	1.35 V	1.4 V	1.45 V	1.5 V
400	N/A	N/A	91.41	95.7	100.11	104.51	109.01
350	N/A	N/A	80.56	84.37	88.26	92.17	96.17
300	63.31	66.51	69.78	73.09	76.51	79.93	83.42
250	53.36	56.10	58.88	61.72	64.64	67.56	70.55
200	43.49	45.76	48.08	50.44	52.86	55.28	57.77
100	23.6	24.93	26.29	27.68	29.12	30.56	32.04

<sup>1</sup> The values are not guaranteed as standalone maximum specifications. They must be combined with static current per the equations of [Electrical Characteristics on Page 31](#).

<sup>2</sup> Valid frequency and voltage ranges are model-specific. See [Operating Conditions for ADSP-BF522/ADSP-BF524/ADSP-BF526 Processors on Page 27](#).

# ADSP-BF522/ADSP-BF523/ADSP-BF524/ADSP-BF525/ADSP-BF526/ADSP-BF527

**Table 24. Static Current —  $I_{DD-DEEPSLEEP}$  (mA) for ADSP-BF523/ADSP-BF525/ADSP-BF527 Processors**

$T_J$ (°C) <sup>1</sup>	Voltage ( $V_{DDINT}$ ) <sup>1</sup>							
	0.95 V	1.00 V	1.05 V	1.10 V	1.15 V	1.20 V	1.25 V	1.30 V
-40	6.5	7.8	9.3	11.1	13.1	15.4	18.0	21.0
-20	9.0	10.6	12.4	14.6	17.0	19.8	22.9	26.4
0	13.2	15.2	17.7	20.4	23.5	27.0	30.9	35.3
25	22.3	25.4	28.9	32.8	37.2	42.1	47.6	53.7
40	30.8	34.8	39.2	44.1	49.6	55.7	62.5	70.0
55	42.9	47.9	53.6	59.9	66.9	74.6	83.2	92.6
70	59.1	65.6	72.9	80.8	89.7	99.4	110.2	122.0
85	80.4	88.6	97.9	107.8	119.2	131.5	145.1	159.8
100	109.3	118.7	130.5	143.2	157.4	172.8	189.7	208.1
105	120.8	132.1	144.7	158.8	174.2	190.9	209.3	229.2
115	144.4	157.5	172.3	188.4	206.0	225.3	246.4	269.2
125	173.9	189.1	206.4	224.9	245.4	267.8	292.2	318.7

<sup>1</sup> Valid temperature and voltage ranges are model-specific. See [Operating Conditions for ADSP-BF523/ADSP-BF525/ADSP-BF527 Processors on Page 29](#).

**Table 25. Dynamic Current in CCLK Domain (mA, with ASF = 1.0)<sup>1</sup> for ADSP-BF523/ADSP-BF525/ADSP-BF527 Processors**

$f_{CCLK}$ (MHz) <sup>2</sup>	Voltage ( $V_{DDINT}$ ) <sup>2</sup>							
	0.95 V	1.00 V	1.05 V	1.10 V	1.15 V	1.20 V	1.25 V	1.30 V
600	N/A	N/A	N/A	N/A	130.4	137.6	145.1	152.5
533	N/A	N/A	N/A	110.3	116.7	123.3	129.8	136.4
500	N/A	N/A	97.3	103.1	109.1	115.0	121.3	127.7
400	69.8	74.3	78.9	83.6	88.5	93.5	98.6	103.9
300	53.4	56.9	60.4	64.1	68.0	71.8	75.8	80.0
200	36.9	39.4	41.9	44.6	47.4	50.1	53.0	56.0
100	20.5	22.0	23.6	25.3	27.0	28.8	30.6	32.5

<sup>1</sup> The values are not guaranteed as standalone maximum specifications. They must be combined with static current per the equations of [Electrical Characteristics on Page 31](#).

<sup>2</sup> Valid frequency and voltage ranges are model-specific. See [Operating Conditions for ADSP-BF523/ADSP-BF525/ADSP-BF527 Processors on Page 29](#).

# ADSP-BF522/ADSP-BF523/ADSP-BF524/ADSP-BF525/ADSP-BF526/ADSP-BF527

## ABSOLUTE MAXIMUM RATINGS

Stresses greater than those listed in Table 26 may cause permanent damage to the device. These are stress ratings only. Functional operation of the device at these or any other condi-

tions greater than those indicated in the operational sections of this specification is not implied. Exposure to absolute maximum rating conditions for extended periods may affect device reliability.

Table 26. Absolute Maximum Ratings

Parameter	Rating
Internal Supply Voltage ( $V_{DDINT}$ ) for ADSP-BF523/ADSP-BF525/ADSP-BF527 processors	-0.3 V to +1.26 V
Internal Supply Voltage ( $V_{DDINT}$ ) for ADSP-BF522/ADSP-BF524/ADSP-BF526 processors	-0.3 V to +1.47 V
External (I/O) Supply Voltage ( $V_{DDEXT}/V_{DDMEM}$ )	-0.3 V to +3.8 V
Real-Time Clock Supply Voltage ( $V_{DDRTC}$ )	-0.5 V to +3.8 V
OTP Supply Voltage ( $V_{DDOTP}$ )	-0.5 V to +3.0 V
OTP Programming Voltage ( $V_{PPOTP}$ ) <sup>1</sup>	-0.5 V to +3.0 V
OTP Programming Voltage ( $V_{PPOTP}$ ) <sup>2</sup>	-0.5 V to +7.1 V
USB PHY Supply Voltage ( $V_{DDUSB}$ )	-0.5 V to +3.8 V
Input Voltage <sup>3, 4, 5</sup>	-0.5 V to +3.8 V
Input Voltage <sup>3, 4, 6</sup>	-0.5 V to +5.5 V
Input Voltage <sup>3, 4, 7</sup>	-0.5 V to +5.25 V
Output Voltage Swing	-0.5 V to $V_{DDEXT}/V_{DDMEM} + 0.5$ V
$I_{OH}/I_{OL}$ Current per Pin Group <sup>3, 8</sup>	82 mA (max)
Storage Temperature Range	-65°C to +150°C
Junction Temperature While Biased	+110°C

<sup>1</sup> Applies to OTP memory reads and writes for ADSP-BF523/ADSP-BF525/ADSP-BF527 processors and to OTP memory reads for ADSP-BF522/ADSP-BF524/ADSP-BF526 processors.

<sup>2</sup> Applies only to OTP memory writes for ADSP-BF522/ADSP-BF524/ADSP-BF526 processors.

<sup>3</sup> Applies to 100% transient duty cycle.

<sup>4</sup> Applies only when  $V_{DDEXT}$  is within specifications. When  $V_{DDEXT}$  is outside specifications, the range is  $V_{DDEXT} \pm 0.2$  V.

<sup>5</sup> For other duty cycles see Table 27.

<sup>6</sup> Applies to balls SCL and SDA.

<sup>7</sup> Applies to balls USB\_DP, USB\_DM, and USB\_VBUS.

<sup>8</sup> For pin group information, see Table 28. For other duty cycles see Table 29.

Table 27. Maximum Duty Cycle for Input Transient Voltage<sup>1, 2</sup>

Maximum Duty Cycle <sup>3</sup>	$V_{IN}$ Min (V) <sup>4</sup>	$V_{IN}$ Max (V) <sup>6</sup>
100%	-0.50	+3.80
40%	-0.70	+4.00
25%	-0.80	+4.10
15%	-0.90	+4.20
10%	-1.00	+4.30

<sup>1</sup> Applies to all signal balls with the exception of CLKIN, XTAL,  $V_{ROUT}/EXT\_WAKE1$ , SCL, SDA, USB\_DP, USB\_DM, and USB\_VBUS.

<sup>2</sup> Applies only when  $V_{DDEXT}$  is within specifications. When  $V_{DDEXT}$  is outside specifications, the range is  $V_{DDEXT} \pm 0.2$  V.

<sup>3</sup> Duty cycle refers to the percentage of time the signal exceeds the value for the 100% case. This is equivalent to the measured duration of a single instance of overshoot or undershoot as a percentage of the period of occurrence.

<sup>4</sup> The individual values cannot be combined for analysis of a single instance of overshoot or undershoot. The worst case observed value must fall within one of the voltages specified, and the total duration of the overshoot or undershoot (exceeding the 100% case) must be less than or equal to the corresponding duty cycle.

Table 26 specifies the maximum total source/sink ( $I_{OH}/I_{OL}$ ) current for a group of pins. Permanent damage can occur if this value is exceeded. To understand this specification, if pins PH4, PH3, PH2, PH1, and PH0 from group 1 in Table 28 were sourcing or sinking 2 mA each, the total current for those pins would be 10 mA. This would allow up to 72 mA total that could be sourced or sunk by the remaining pins in the group without damaging the device. For a list of all groups and their pins, see the Table 28 table. For duty cycles that are less than 100%, see Table 29. Note that the  $V_{OH}$  and  $V_{OL}$  specifications have separate per-pin maximum current requirements (see Table 19 on Page 32 and Table 20 on Page 33).

Table 28. Total Current Pin Groups

Group	Pins in Group
1	PH4, PH3, PH2, PH1, PH0, PF15, PF14, PF13
2	PF12, SDA, SCL, PF11, PF10, PF9, PF8, PF7
3	PF6, PF5, PF4, PF3, PF2, PF1, PF0, PPI_FS1
4	PPI_CLK, PG15, PG14, PG13, PG12, PG11, PG10, PG9
5	PG8, PG7, PG6, PG5, PG4, BMODE3, BMODE2, BMODE1

# ADSP-BF522/ADSP-BF523/ADSP-BF524/ADSP-BF525/ADSP-BF526/ADSP-BF527

**Table 28. Total Current Pin Groups (Continued)**

Group	Pins in Group
6	BMODE0, PG3, PG2, PG1, PG0, TDI, TDO, $\overline{\text{EMU}}$
7	TCK, $\overline{\text{TRST}}$ , TMS
8	PH12, PH11, PH10, PH9, PH8, PH7, PH6, PH5
9	PH15, PH14, PH13, CLKBUF, $\overline{\text{NMI}}$ , $\overline{\text{RESET}}$
10	DATA15, DATA14, DATA13, DATA12, DATA11, DATA10
11	DATA9, DATA8, DATA7, DATA6, DATA5, DATA4
12	DATA3, DATA2, DATA1, DATA0, ADDR19, ADDR18
13	ADDR17, ADDR16, ADDR15, ADDR14, ADDR13
14	ADDR12, ADDR11, ADDR10, ADDR9, ADDR8, ADDR7
15	ADDR6, ADDR5, ADDR4, ADDR3, ADDR2, ADDR1
16	$\overline{\text{ABE1}}$ , $\overline{\text{ABE0}}$ , SA10, $\overline{\text{SWE}}$ , $\overline{\text{SCAS}}$ , $\overline{\text{SRAS}}$
17	$\overline{\text{SMS}}$ , SCKE, ARDY, $\overline{\text{AWE}}$ , $\overline{\text{ARE}}$ , $\overline{\text{AOE}}$
18	$\overline{\text{AMS3}}$ , $\overline{\text{AMS2}}$ , $\overline{\text{AMS1}}$ , $\overline{\text{AMS0}}$ , CLKOUT

**Table 29. Maximum Duty Cycle for  $I_{OH}/I_{OL}$  Current Per Pin Group**

Maximum Duty Cycle	RMS Current (mA)
100%	82
80%	92
60%	106
40%	130
25%	165
10%	261

When programming OTP memory on the ADSP-BF522/ADSP-BF524/ADSP-BF526 processors, the VPPOTP ball must be set to the write value specified in the [Operating Conditions for ADSP-BF522/ADSP-BF524/ADSP-BF526 Processors on Page 27](#). There is a finite amount of cumulative time that the write voltage may be applied (dependent on voltage and junction temperature) to VPPOTP over the lifetime of the part. Therefore, maximum OTP memory programming time for the ADSP-BF522/ADSP-BF524/ADSP-BF526 processors is shown in [Table 30](#). The ADSP-BF523/ADSP-BF525/ADSP-BF527 processors do not have a similar restriction.

**Table 30. Maximum OTP Memory Programming Time for ADSP-BF522/ADSP-BF524/ADSP-BF526 Processors**

$V_{PPOTP}$ Voltage (V)	Temperature ( $T_j$ )		
	25°C	85°C	105°C
6.9	6000 sec	100 sec	25 sec
7.0	2400 sec	44 sec	12 sec
7.1	1000 sec	18 sec	4.5 sec

## PACKAGE INFORMATION

The information presented in [Figure 8](#) and [Table 31](#) provides details about the package branding for the ADSP-BF52x processors. For a complete listing of product availability, see [Ordering Guide on Page 87](#).



Figure 8. Product Information on Package

**Table 31. Package Brand Information<sup>1</sup>**

Brand Key	Field Description
ADSP-BF52x	Product Name <sup>2</sup>
t	Temperature Range
pp	Package Type
Z	Lead Free Option
ccc	See Ordering Guide
vvvvv.x	Assembly Lot Code
n.n	Silicon Revision
#	RoHS Compliance Designator
yyww	Date Code

<sup>1</sup> Non Automotive only. For branding information specific to Automotive products, contact Analog Devices Inc.

<sup>2</sup> See product names in the [Ordering Guide on Page 87](#).

## ESD SENSITIVITY

	<p><b>ESD (electrostatic discharge) sensitive device.</b> Charged devices and circuit boards can discharge without detection. Although this product features patented or proprietary protection circuitry, damage may occur on devices subjected to high energy ESD. Therefore, proper ESD precautions should be taken to avoid performance degradation or loss of functionality.</p>
--	---

# ADSP-BF522/ADSP-BF523/ADSP-BF524/ADSP-BF525/ADSP-BF526/ADSP-BF527

## TIMING SPECIFICATIONS

Specifications are subject to change without notice.

### Clock and Reset Timing

Table 32 and Figure 9 describe clock and reset operations. Per the CCLK and SCLK timing specifications in Table 12 to Table 17, combinations of CLKIN and clock multipliers must not select core/peripheral clocks in excess of the processor's maximum instruction rate.

Table 32. Clock and Reset Timing

Parameter		Min	Max	Unit
<i>Timing Requirements</i>				
$f_{CKIN}$	CLKIN Frequency (Commercial/ Industrial Models) <sup>1,2,3,4</sup>	12	50	MHz
	CLKIN Frequency (Automotive Models) <sup>1,2,3,4</sup>	14	50	MHz
$t_{CKINL}$	CLKIN Low Pulse <sup>1</sup>	10		ns
$t_{CKINH}$	CLKIN High Pulse <sup>1</sup>	10		ns
$t_{WRST}$	$\overline{RESET}$ Asserted Pulse Width Low <sup>5</sup>	$11 \times t_{CKIN}$		ns
<i>Switching Characteristic</i>				
$t_{BUFDLAY}$	CLKIN to CLKBUF Delay		10	ns

<sup>1</sup> Applies to PLL bypass mode and PLL nonbypass mode.

<sup>2</sup> Combinations of the CLKIN frequency and the PLL clock multiplier must not exceed the allowed  $f_{VCO}$ ,  $f_{CLK}$ , and  $f_{SCLK}$  settings discussed in Table 12 on Page 28 through Table 14 on Page 28 and Table 15 on Page 30 through Table 17 on Page 30.

<sup>3</sup> The  $t_{CKIN}$  period (see Figure 9) equals  $1/f_{CKIN}$ .

<sup>4</sup> If the DF bit in the PLL\_CTL register is set, the minimum  $f_{CKIN}$  specification is 24 MHz for commercial/industrial models and 28 MHz for automotive models.

<sup>5</sup> Applies after power-up sequence is complete. See Table 33 and Figure 10 for power-up reset timing.

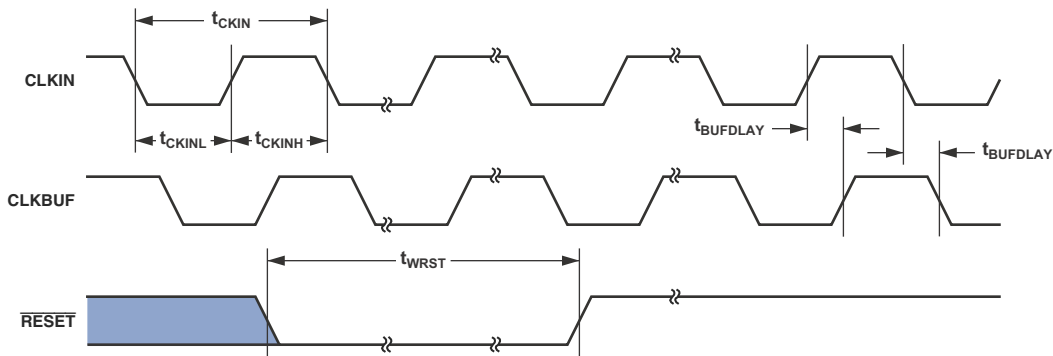
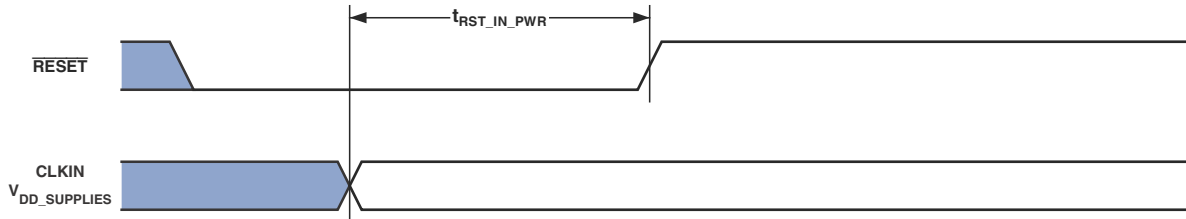

Figure 9. Clock and Reset Timing

# ADSP-BF522/ADSP-BF523/ADSP-BF524/ADSP-BF525/ADSP-BF526/ADSP-BF527

**Table 33. Power-Up Reset Timing**

Parameter	Min	Max	Unit
<i>Timing Requirements</i>			
$t_{RST\_IN\_PWR}$ $\overline{RESET}$ Deasserted after the $V_{DDINT}$ , $V_{DDEXT}$ , $V_{DDRTC}$ , $V_{DDUSB}$ , $V_{DDMEM}$ , $V_{DDOTP}$ , and CLKIN Pins are Stable and Within Specification	$3500 \times t_{CKIN}$		ns



In Figure 10,  $V_{DD\_SUPPLIES}$  is  $V_{DDINT}$ ,  $V_{DDEXT}$ ,  $V_{DDRTC}$ ,  $V_{DDUSB}$ ,  $V_{DDMEM}$ , and  $V_{DDOTP}$ .

Figure 10. Power-Up Reset Timing

# ADSP-BF522/ADSP-BF523/ADSP-BF524/ADSP-BF525/ADSP-BF526/ADSP-BF527

## Asynchronous Memory Read Cycle Timing

Table 34. Asynchronous Memory Read Cycle Timing

Parameter	ADSP-BF522/ADSP-BF524/ ADSP-BF526				ADSP-BF523/ADSP-BF525/ ADSP-BF527				Unit		
	$V_{DDMEM}$ 1.8 V Nominal		$V_{DDMEM}$ 2.5 V or 3.3 V Nominal		$V_{DDMEM}$ 1.8 V Nominal		$V_{DDMEM}$ 2.5 V or 3.3 V Nominal				
	Min	Max	Min	Max	Min	Max	Min	Max			
<i>Timing Requirements</i>											
$t_{SDAT}$	DATA15-0 Setup Before CLKOUT		2.1		2.1		2.1		2.1		ns
$t_{HDAT}$	DATA15-0 Hold After CLKOUT		1.2		0.8		0.9		0.8		ns
$t_{SARDY}$	ARDY Setup Before CLKOUT		4.0		4.0		4.0		4.0		ns
$t_{HARDY}$	ARDY Hold After CLKOUT		0.2		0.2		0.2		0.2		ns
<i>Switching Characteristics</i>											
$t_{DO}$	Output Delay After CLKOUT <sup>1</sup>			6.0		6.0		6.0		6.0	ns
$t_{HO}$	Output Hold After CLKOUT <sup>1</sup>		0.8		0.8		0.8		0.8		ns

<sup>1</sup> Output balls include  $\overline{AMS3-0}$ ,  $\overline{ABE1-0}$ ,  $\overline{ADDR19-1}$ ,  $\overline{AOE}$ ,  $\overline{ARE}$ .

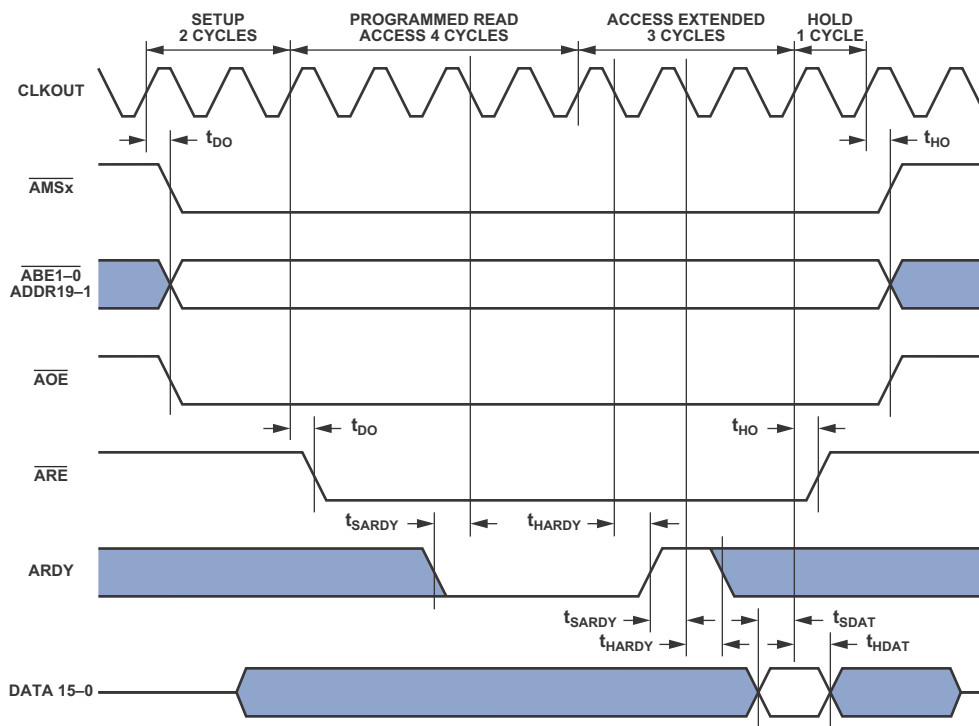

Figure 11. Asynchronous Memory Read Cycle Timing



# ADSP-BF522/ADSP-BF523/ADSP-BF524/ADSP-BF525/ADSP-BF526/ADSP-BF527

## Asynchronous Memory Write Cycle Timing

Table 35. Asynchronous Memory Write Cycle Timing

Parameter		ADSP-BF522/ADSP-BF524/ ADSP-BF526				ADSP-BF523/ADSP-BF525/ ADSP-BF527				Unit
		$V_{DDMEM}$ 1.8 V Nominal		$V_{DDMEM}$ 2.5 V or 3.3 V Nominal		$V_{DDMEM}$ 1.8 V Nominal		$V_{DDMEM}$ 2.5 V or 3.3 V Nominal		
		Min	Max	Min	Max	Min	Max	Min	Max	
<i>Timing Requirements</i>										
$t_{SARDY}$	ARDY Setup Before CLKOUT	4.0		4.0		4.0		4.0		ns
$t_{HARDY}$	ARDY Hold After CLKOUT	0.2		0.2		0.2		0.2		ns
<i>Switching Characteristics</i>										
$t_{DDAT}$	DATA15–0 Disable After CLKOUT		6.0		6.0		6.0		6.0	ns
$t_{ENDAT}$	DATA15–0 Enable After CLKOUT	0.0		0.0		0.0		0.0		ns
$t_{DO}$	Output Delay After CLKOUT <sup>1</sup>		6.0		6.0		6.0		6.0	ns
$t_{HO}$	Output Hold After CLKOUT <sup>1</sup>	0.8		0.8		0.8		0.8		ns

<sup>1</sup> Output balls include AMS3–0, ABE1–0, ADDR19–1, DATA15–0, AWE.



Figure 12. Asynchronous Memory Write Cycle Timing

# ADSP-BF522/ADSP-BF523/ADSP-BF524/ADSP-BF525/ADSP-BF526/ADSP-BF527

## NAND Flash Controller Interface Timing

Table 36 and Figure 13 on Page 43 through Figure 17 on Page 45 describe NAND Flash Controller Interface operations.

**Table 36. NAND Flash Controller Interface Timing**

Parameter		$V_{DDEXT}$ 1.8 V Nominal	$V_{DDEXT}$ 2.5 V or 3.3 V Nominal	Unit
		Min	Min	
<b>Write Cycle</b>				
<i>Switching Characteristics</i>				
$t_{CWL}$	$\overline{ND\_CE}$ Setup Time to $\overline{AWE}$ Low	$1.0 \times t_{SCLK} - 4$	$1.0 \times t_{SCLK} - 4$	ns
$t_{CH}$	$\overline{ND\_CE}$ Hold Time From $\overline{AWE}$ High	$3.0 \times t_{SCLK} - 4$	$3.0 \times t_{SCLK} - 4$	ns
$t_{CLEWL}$	$\overline{ND\_CLE}$ Setup Time to $\overline{AWE}$ Low	0.0	0.0	ns
$t_{CLH}$	$\overline{ND\_CLE}$ Hold Time From $\overline{AWE}$ high	$2.5 \times t_{SCLK} - 4$	$2.5 \times t_{SCLK} - 4$	ns
$t_{ALEWL}$	$\overline{ND\_ALE}$ Setup Time to $\overline{AWE}$ Low	0.0	0.0	ns
$t_{ALH}$	$\overline{ND\_ALE}$ Hold Time From $\overline{AWE}$ High	$2.5 \times t_{SCLK} - 4$	$2.5 \times t_{SCLK} - 4$	ns
$t_{WP}^1$	$\overline{AWE}$ Low to $\overline{AWE}$ high	$(WR\_DLY + 1.0) \times t_{SCLK} - 4$	$(WR\_DLY + 1.0) \times t_{SCLK} - 4$	ns
$t_{WHWL}$	$\overline{AWE}$ High to $\overline{AWE}$ Low	$4.0 \times t_{SCLK} - 4$	$4.0 \times t_{SCLK} - 4$	ns
$t_{WC}^1$	$\overline{AWE}$ Low to $\overline{AWE}$ Low	$(WR\_DLY + 5.0) \times t_{SCLK} - 4$	$(WR\_DLY + 5.0) \times t_{SCLK} - 4$	ns
$t_{DWS}^1$	Data Setup Time for a Write Access	$(WR\_DLY + 1.5) \times t_{SCLK} - 4$	$(WR\_DLY + 1.5) \times t_{SCLK} - 4$	ns
$t_{DWH}$	Data Hold Time for a Write Access	$2.5 \times t_{SCLK} - 4$	$2.5 \times t_{SCLK} - 4$	ns
<b>Read Cycle</b>				
<i>Switching Characteristics</i>				
$t_{CRL}$	$\overline{ND\_CE}$ Setup Time to $\overline{ARE}$ Low	$1.0 \times t_{SCLK} - 4$	$1.0 \times t_{SCLK} - 4$	ns
$t_{CRH}$	$\overline{ND\_CE}$ Hold Time From $\overline{ARE}$ High	$3.0 \times t_{SCLK} - 4$	$3.0 \times t_{SCLK} - 4$	ns
$t_{RP}^1$	$\overline{ARE}$ Low to $\overline{ARE}$ High	$(RD\_DLY + 1.0) \times t_{SCLK} - 4$	$(RD\_DLY + 1.0) \times t_{SCLK} - 4$	ns
$t_{RHRL}$	$\overline{ARE}$ High to $\overline{ARE}$ Low	$4.0 \times t_{SCLK} - 4$	$4.0 \times t_{SCLK} - 4$	ns
$t_{RC}^1$	$\overline{ARE}$ Low to $\overline{ARE}$ Low	$(RD\_DLY + 5.0) \times t_{SCLK} - 4$	$(RD\_DLY + 5.0) \times t_{SCLK} - 4$	ns
<i>Timing Requirements (ADSP-BF522/ADSP-BF524/ADSP-BF526)</i>				
$t_{DRS}$	Data Setup Time for a Read Transaction	14.0	10.0	ns
$t_{DRH}$	Data Hold Time for a Read Transaction	0.0	0.0	ns
<i>Timing Requirements (ADSP-BF523/ADSP-BF525/ADSP-BF527)</i>				
$t_{DRS}$	Data Setup Time for a Read Transaction	11.0	8.0	ns
$t_{DRH}$	Data Hold Time for a Read Transaction	0.0	0.0	ns
<b>Write Followed by Read</b>				
<i>Switching Characteristics</i>				
$t_{WHRL}$	$\overline{AWE}$ High to $\overline{ARE}$ Low	$5.0 \times t_{SCLK} - 4$	$5.0 \times t_{SCLK} - 4$	ns

<sup>1</sup> WR\_DLY and RD\_DLY are defined in the NFC\_CTL register.



In Figure 13, ND\_DATA is ND\_D0–D7.

Figure 13. NAND Flash Controller Interface Timing — Command Write Cycle



In Figure 14, ND\_DATA is ND\_D0–D7.

Figure 14. NAND Flash Controller Interface Timing — Address Write Cycle



In Figure 15, ND\_DATA is ND\_D0–D7.

Figure 15. NAND Flash Controller Interface Timing — Data Write Operation



In Figure 16, ND\_DATA is ND\_D0–D7.

Figure 16. NAND Flash Controller Interface Timing — Data Read Operation



In Figure 17,  $\text{ND\_DATA}$  is  $\text{ND\_D0-D7}$ .

Figure 17. NAND Flash Controller Interface Timing — Write Followed by Read Operation

# ADSP-BF522/ADSP-BF523/ADSP-BF524/ADSP-BF525/ADSP-BF526/ADSP-BF527

## SDRAM Interface Timing

**Table 37. SDRAM Interface Timing for ADSP-BF522/ADSP-BF524/ADSP-BF526 Processors**

Parameter	$V_{DDMEM}$ 1.8V Nominal		$V_{DDMEM}$ 2.5V or 3.3V Nominal		Unit
	Min	Max	Min	Max	
<i>Timing Requirements</i>					
$t_{SSDAT}$	Data Setup Before CLKOUT		1.5	1.5	ns
$t_{HSDAT}$	Data Hold After CLKOUT		1.3	0.8	ns
<i>Switching Characteristics</i>					
$t_{SCLK}$	CLKOUT Period <sup>1</sup>		12.5	10	ns
$t_{SCLKH}$	CLKOUT Width High		5.0	4.0	ns
$t_{SCLKL}$	CLKOUT Width Low		5.0	4.0	ns
$t_{DCAD}$	Command, Address, Data Delay After CLKOUT <sup>2</sup>			4.0	ns
$t_{HCAD}$	Command, Address, Data Hold After CLKOUT <sup>2</sup>		1.0		ns
$t_{DSDAT}$	Data Disable After CLKOUT			5.0	ns
$t_{ENSDAT}$	Data Enable After CLKOUT		0.0	0.0	ns

<sup>1</sup>The  $t_{SCLK}$  value is the inverse of the  $f_{SCLK}$  specification discussed in Table 14 and Table 17. Package type and reduced supply voltages affect the best-case values listed here.

<sup>2</sup>Command balls include: SRAS, SCAS, SWE, SDQM, SMS, SA10, SCKE.

**Table 38. SDRAM Interface Timing for ADSP-BF523/ADSP-BF525/ADSP-BF527 Processors**

Parameter	$V_{DDMEM}$ 1.8V Nominal		$V_{DDMEM}$ 2.5V or 3.3V Nominal		Unit
	Min	Max	Min	Max	
<i>Timing Requirements</i>					
$t_{SSDAT}$	Data Setup Before CLKOUT		1.5	1.5	ns
$t_{HSDAT}$	Data Hold After CLKOUT		1.0	0.8	ns
<i>Switching Characteristics</i>					
$t_{SCLK}$	CLKOUT Period <sup>1</sup>		10	7.5	ns
$t_{SCLKH}$	CLKOUT Width High		2.5	2.5	ns
$t_{SCLKL}$	CLKOUT Width Low		2.5	2.5	ns
$t_{DCAD}$	Command, Address, Data Delay After CLKOUT <sup>2</sup>			4.0	ns
$t_{HCAD}$	Command, Address, Data Hold After CLKOUT <sup>2</sup>		1.0	1.0	ns
$t_{DSDAT}$	Data Disable After CLKOUT			4.0	ns
$t_{ENSDAT}$	Data Enable After CLKOUT		0.0	0.0	ns

<sup>1</sup>The  $t_{SCLK}$  value is the inverse of the  $f_{SCLK}$  specification discussed in Table 14 and Table 17. Package type and reduced supply voltages affect the best-case values listed here.

<sup>2</sup>Command balls include: SRAS, SCAS, SWE, SDQM, SMS, SA10, SCKE.



NOTE: COMMAND =  $\overline{SRAS}$ ,  $\overline{SCAS}$ ,  $\overline{SWE}$ ,  $SDQM$ ,  $\overline{SMS}$ , SA10, SCKE.

Figure 18. SDRAM Interface Timing

# ADSP-BF522/ADSP-BF523/ADSP-BF524/ADSP-BF525/ADSP-BF526/ADSP-BF527

## External DMA Request Timing

Table 40 and Figure 19 describe the External DMA Request operations.

**Table 39. External DMA Request Timing for ADSP-BF522/ADSP-BF524/ADSP-BF526 Processors<sup>1</sup>**

Parameter	$V_{DDEXT}/V_{DDMEM}$ 1.8 V Nominal		$V_{DDEXT}/V_{DDMEM}$ 2.5 V or 3.3 V Nominal		Unit
	Min	Max	Min	Max	
<i>Timing Requirements</i>					
$t_{DS}$	DMARx Asserted to CLKOUT High Setup		9.0	6.0	ns
$t_{DH}$	CLKOUT High to DMARx Deasserted Hold Time		0.0	0.0	ns
$t_{DMARACT}$	DMARx Active Pulse Width		$1.0 \times t_{SCLK}$	$1.0 \times t_{SCLK}$	ns
$t_{DMARINACT}$	DMARx Inactive Pulse Width		$1.75 \times t_{SCLK}$	$1.75 \times t_{SCLK}$	ns

<sup>1</sup> Because the external DMA control pins are part of the  $V_{DDEXT}$  power domain and the CLKOUT signal is part of the  $V_{DDMEM}$  power domain, systems in which  $V_{DDEXT}$  and  $V_{DDMEM}$  are NOT equal may require level shifting logic for correct operation.

**Table 40. External DMA Request Timing for ADSP-BF523/ADSP-BF525/ADSP-BF527 Processors<sup>1</sup>**

Parameter	$V_{DDEXT}/V_{DDMEM}$ 1.8 V Nominal		$V_{DDEXT}/V_{DDMEM}$ 2.5 V or 3.3 V Nominal		Unit
	Min	Max	Min	Max	
<i>Timing Requirements</i>					
$t_{DS}$	DMARx Asserted to CLKOUT High Setup		8.0	6.0	ns
$t_{DH}$	CLKOUT High to DMARx Deasserted Hold Time		0.0	0.0	ns
$t_{DMARACT}$	DMARx Active Pulse Width		$1.0 \times t_{SCLK}$	$1.0 \times t_{SCLK}$	ns
$t_{DMARINACT}$	DMARx Inactive Pulse Width		$1.75 \times t_{SCLK}$	$1.75 \times t_{SCLK}$	ns

<sup>1</sup> Because the external DMA control pins are part of the  $V_{DDEXT}$  power domain and the CLKOUT signal is part of the  $V_{DDMEM}$  power domain, systems in which  $V_{DDEXT}$  and  $V_{DDMEM}$  are NOT equal may require level shifting logic for correct operation.



Figure 19. External DMA Request Timing



# ADSP-BF522/ADSP-BF523/ADSP-BF524/ADSP-BF525/ADSP-BF526/ADSP-BF527

## Parallel Peripheral Interface Timing

Table 41 and Figure 20 on Page 50, Figure 24 on Page 54, and Figure 27 on Page 56 describe parallel peripheral interface operations.

**Table 41. Parallel Peripheral Interface Timing for ADSP-BF522/ADSP-BF524/ADSP-BF526 Processors**

Parameter	V <sub>DDEXT</sub> 1.8V Nominal		V <sub>DDEXT</sub> 2.5 V or 3.3 V Nominal		Unit
	Min	Max	Min	Max	
<i>Timing Requirements</i>					
t <sub>PCLKW</sub>	PPI_CLK Width <sup>1</sup>		6.4	6.4	ns
t <sub>PCLK</sub>	PPI_CLK Period <sup>1</sup>		25.0	20.0	ns
<i>Timing Requirements - GP Input and Frame Capture Modes</i>					
t <sub>SFSPE</sub>	External Frame Sync Setup Before PPI_CLK (Nonsampling Edge for Rx, Sampling Edge for Tx)		6.7	6.7	ns
t <sub>HFSPE</sub>	External Frame Sync Hold After PPI_CLK		1.2	1.2	ns
t <sub>SDRPE</sub>	Receive Data Setup Before PPI_CLK		4.1	3.5	ns
t <sub>HDRPE</sub>	Receive Data Hold After PPI_CLK		2.0	1.6	ns
<i>Switching Characteristics - GP Output and Frame Capture Modes</i>					
t <sub>DFSPE</sub>	Internal Frame Sync Delay After PPI_CLK			8.0	ns
t <sub>HOFSPPE</sub>	Internal Frame Sync Hold After PPI_CLK		1.7	1.7	ns
t <sub>DDTPE</sub>	Transmit Data Delay After PPI_CLK			8.0	ns
t <sub>HDTPE</sub>	Transmit Data Hold After PPI_CLK		2.3	1.9	ns

<sup>1</sup> PPI\_CLK frequency cannot exceed f<sub>CLK</sub>/2

**Table 42. Parallel Peripheral Interface Timing for ADSP-BF523/ADSP-BF525/ADSP-BF527 Processors**

Parameter	V <sub>DDEXT</sub> 1.8V Nominal		V <sub>DDEXT</sub> 2.5 V or 3.3 V Nominal		Unit
	Min	Max	Min	Max	
<i>Timing Requirements</i>					
t <sub>PCLKW</sub>	PPI_CLK Width <sup>1</sup>		6.0	6.0	ns
t <sub>PCLK</sub>	PPI_CLK Period <sup>1</sup>		20.0	15.0	ns
<i>Timing Requirements - GP Input and Frame Capture Modes</i>					
t <sub>SFSPE</sub>	External Frame Sync Setup Before PPI_CLK (Nonsampling Edge for Rx, Sampling Edge for Tx)		6.7	6.7	ns
t <sub>HFSPE</sub>	External Frame Sync Hold After PPI_CLK		1.0	1.0	ns
t <sub>SDRPE</sub>	Receive Data Setup Before PPI_CLK		3.5	3.5	ns
t <sub>HDRPE</sub>	Receive Data Hold After PPI_CLK		2.0	1.6	ns
<i>Switching Characteristics - GP Output and Frame Capture Modes</i>					
t <sub>DFSPE</sub>	Internal Frame Sync Delay After PPI_CLK			8.0	ns
t <sub>HOFSPPE</sub>	Internal Frame Sync Hold After PPI_CLK		1.7	1.7	ns
t <sub>DDTPE</sub>	Transmit Data Delay After PPI_CLK			8.0	ns
t <sub>HDTPE</sub>	Transmit Data Hold After PPI_CLK		2.3	1.9	ns

<sup>1</sup> PPI\_CLK frequency cannot exceed f<sub>CLK</sub>/2

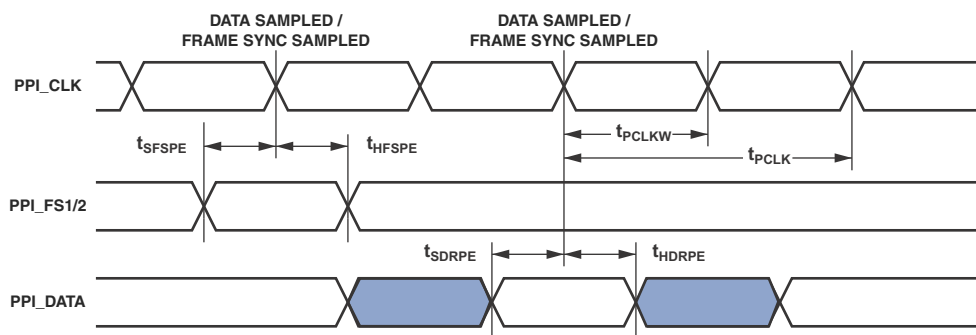

Figure 20. PPI GP Rx Mode with External Frame Sync Timing

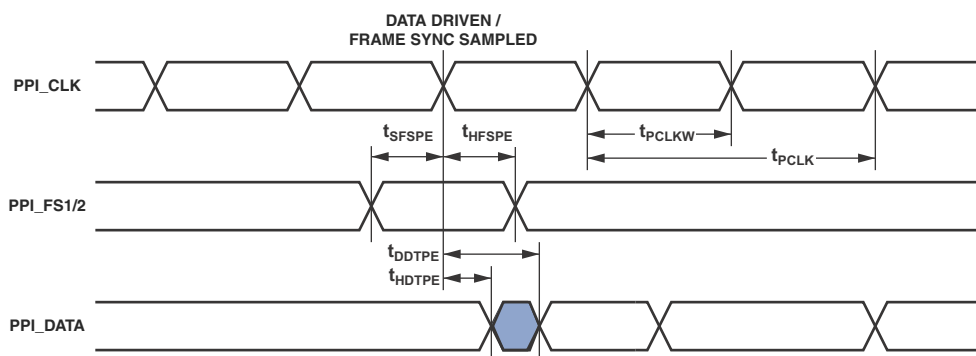

Figure 21. PPI GP Tx Mode with External Frame Sync Timing

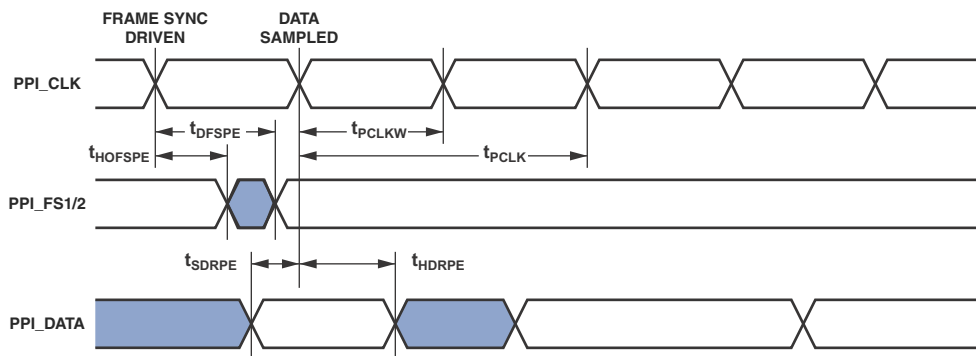

Figure 22. PPI GP Rx Mode with Internal Frame Sync Timing



Figure 23. PPI GP Tx Mode with Internal Frame Sync Timing

# ADSP-BF522/ADSP-BF523/ADSP-BF524/ADSP-BF525/ADSP-BF526/ADSP-BF527

## Serial Ports

Table 43 through Table 47 on Page 56 and Figure 24 on Page 54 through Figure 27 on Page 56 describe serial port operations.

**Table 43. Serial Ports—External Clock**

Parameter	ADSP-BF522/ADSP-BF524/ADSP-BF526				ADSP-BF523/ADSP-BF525/ ADSP-BF527				Unit
	$V_{DDEXT}$ 1.8V Nominal		$V_{DDEXT}$ 2.5V or 3.3V Nominal		$V_{DDEXT}$ 1.8V Nominal		$V_{DDEXT}$ 2.5V or 3.3V Nominal		
	Min	Max	Min	Max	Min	Max	Min	Max	
<i>Timing Requirements</i>									
$t_{SFSE}$ TFSx/RFSx Setup Before TSCLKx RSCLKx <sup>1</sup>	3.0		3.0		3.0		3.0		ns
$t_{HFSE}$ TFSx/RFSx Hold After TSCLKx/RSCLKx <sup>1</sup>	3.0		3.0		3.0		3.0		ns
$t_{SDRE}$ Receive Data Setup Before RSCLKx <sup>1</sup>	3.0		3.0		3.0		3.0		ns
$t_{HDRE}$ Receive Data Hold After RSCLKx <sup>1</sup>	3.5		3.0		3.5		3.0		ns
$t_{SCLKEW}$ TSCLKx/RSCLKx Width	7.0		4.5		7.0		4.5		ns
$t_{SCLKE}$ TSCLKx/RSCLKx Period	$2.0 \times t_{SCLK}$		$2.0 \times t_{SCLK}$		$2.0 \times t_{SCLK}$		$2.0 \times t_{SCLK}$		ns
$t_{SUDE}$ Start-Up Delay From SPORT Enable To First External TFSx <sup>2</sup>	$4.0 \times t_{SCLKE}$		$4.0 \times t_{SCLKE}$		$4.0 \times t_{SCLKE}$		$4.0 \times t_{SCLKE}$		ns
$t_{SUDRE}$ Start-Up Delay From SPORT Enable To First External RFSx <sup>2</sup>	$4.0 \times t_{SCLKE}$		$4.0 \times t_{SCLKE}$		$4.0 \times t_{SCLKE}$		$4.0 \times t_{SCLKE}$		ns
<i>Switching Characteristics</i>									
$t_{DFSE}$ TFSx/RFSx Delay After TSCLKx/RSCLKx (Internally Generated TFSx/RFSx) <sup>3</sup>		10.0		10.0		10.0		10.0	ns
$t_{HOFSE}$ TFSx/RFSx Hold After TSCLKx/RSCLKx (Internally Generated TFSx/RFSx) <sup>3</sup>	0.0		0.0		0.0		0.0		ns
$t_{DDTE}$ Transmit Data Delay After TSCLKx <sup>3</sup>		10.0		10.0		10.0		10.0	ns
$t_{HDTE}$ Transmit Data Hold After TSCLKx <sup>3</sup>	0.0		0.0		0.0		0.0		ns

<sup>1</sup> Referenced to sample edge.

<sup>2</sup> Verified in design but untested.

<sup>3</sup> Referenced to drive edge.

# ADSP-BF522/ADSP-BF523/ADSP-BF524/ADSP-BF525/ADSP-BF526/ADSP-BF527

**Table 44. Serial Ports—Internal Clock for ADSP-BF522/ADSP-BF524/ADSP-BF526 Processors**

Parameter	V <sub>DDEXT</sub> 1.8V Nominal		V <sub>DDEXT</sub> 2.5V or 3.3V Nominal		Unit
	Min	Max	Min	Max	
<i>Timing Requirements</i>					
t <sub>SFSI</sub> TFSx/RFSx Setup Before TSCLKx/RSCLKx <sup>1</sup>	11.0		9.6		ns
t <sub>HFSI</sub> TFSx/RFSx Hold After TSCLKx/RSCLKx <sup>1</sup>	-1.5		-1.5		ns
t <sub>SDRI</sub> Receive Data Setup Before RSCLKx <sup>1</sup>	11.0		9.6		ns
t <sub>HDRI</sub> Receive Data Hold After RSCLKx <sup>1</sup>	-1.5		-1.5		ns
<i>Switching Characteristics</i>					
t <sub>SCLKIW</sub> TSCLKx/RSCLKx Width	10.0		8.0		ns
t <sub>DFSI</sub> TFSx/RFSx Delay After TSCLKx/RSCLKx (Internally Generated TFSx/RFSx) <sup>2</sup>		3.0		3.0	ns
t <sub>HOFSI</sub> TFSx/RFSx Hold After TSCLKx/RSCLKx (Internally Generated TFSx/RFSx) <sup>2</sup>	-2.0		-1.0		ns
t <sub>DDTI</sub> Transmit Data Delay After TSCLKx <sup>2</sup>		3.0		3.0	ns
t <sub>HDTI</sub> Transmit Data Hold After TSCLKx <sup>2</sup>	-1.8		-1.5		ns

<sup>1</sup> Referenced to sample edge.

<sup>2</sup> Referenced to drive edge.

**Table 45. Serial Ports—Internal Clock for ADSP-BF523/ADSP-BF525/ADSP-BF527 Processors**

Parameter	V <sub>DDEXT</sub> 1.8V Nominal		V <sub>DDEXT</sub> 2.5V or 3.3V Nominal		Unit
	Min	Max	Min	Max	
<i>Timing Requirements</i>					
t <sub>SFSI</sub> TFSx/RFSx Setup Before TSCLKx/RSCLKx <sup>1</sup>	11.0		9.6		ns
t <sub>HFSI</sub> TFSx/RFSx Hold After TSCLKx/RSCLKx <sup>1</sup>	-1.5		-1.5		ns
t <sub>SDRI</sub> Receive Data Setup Before RSCLKx <sup>1</sup>	11.0		9.6		ns
t <sub>HDRI</sub> Receive Data Hold After RSCLKx <sup>1</sup>	-1.5		-1.5		ns
<i>Switching Characteristics</i>					
t <sub>SCLKIW</sub> TSCLKx/RSCLKx Width	4.5		4.5		ns
t <sub>DFSI</sub> TFSx/RFSx Delay After TSCLKx/RSCLKx (Internally Generated TFSx/RFSx) <sup>2</sup>		3.0		3.0	ns
t <sub>HOFSI</sub> TFSx/RFSx Hold After TSCLKx/RSCLKx (Internally Generated TFSx/RFSx) <sup>2</sup>	-1.0		-1.0		ns
t <sub>DDTI</sub> Transmit Data Delay After TSCLKx <sup>2</sup>		3.0		3.0	ns
t <sub>HDTI</sub> Transmit Data Hold After TSCLKx <sup>2</sup>	-1.8		-1.5		ns

<sup>1</sup> Referenced to sample edge.

<sup>2</sup> Referenced to drive edge.

# ADSP-BF522/ADSP-BF523/ADSP-BF524/ADSP-BF525/ADSP-BF526/ADSP-BF527



Figure 24. Serial Ports



Figure 25. Serial Port Start Up with External Clock and Frame Sync

# ADSP-BF522/ADSP-BF523/ADSP-BF524/ADSP-BF525/ADSP-BF526/ADSP-BF527

**Table 46. Serial Ports—Enable and Three-State**

Parameter	ADSP-BF522/ADSP-BF524/ADSP-BF526				ADSP-BF523/ADSP-BF525/ADSP-BF527				Unit		
	$V_{DDEXT}$ 1.8 V Nominal		$V_{DDEXT}$ 2.5 V or 3.3 V Nominal		$V_{DDEXT}$ 1.8 V Nominal		$V_{DDEXT}$ 2.5 V or 3.3 V Nominal				
	Min	Max	Min	Max	Min	Max	Min	Max			
<i>Switching Characteristics</i>											
$t_{DTENE}$	Data Enable Delay from External TSCLKx <sup>1</sup>		0.0		0.0		0.0		0.0		ns
$t_{DDTTE}$	Data Disable Delay from External TSCLKx <sup>1</sup>			$t_{SCLK} + 1$		$t_{SCLK} + 1$		$t_{SCLK} + 1$		$t_{SCLK} + 1$	ns
$t_{DTENI}$	Data Enable Delay from Internal TSCLKx <sup>1</sup>		-2.0		-2.0		-2.0		-2.0		ns
$t_{DDTTI}$	Data Disable Delay from Internal TSCLKx <sup>1</sup>			$t_{SCLK} + 1$		$t_{SCLK} + 1$		$t_{SCLK} + 1$		$t_{SCLK} + 1$	ns

<sup>1</sup> Referenced to drive edge.



Figure 26. Serial Ports — Enable and Three-State

# ADSP-BF522/ADSP-BF523/ADSP-BF524/ADSP-BF525/ADSP-BF526/ADSP-BF527

**Table 47. Serial Ports — External Late Frame Sync**

Parameter	ADSP-BF522/ADSP-BF524/ ADSP-BF526				ADSP-BF523/ADSP-BF525/ ADSP-BF527				Unit	
	$V_{DDEXT}$ 1.8V Nominal		$V_{DDEXT}$ 2.5V or 3.3V Nominal		$V_{DDEXT}$ 1.8V Nominal		$V_{DDEXT}$ 2.5V or 3.3V Nominal			
	Min	Max	Min	Max	Min	Max	Min	Max		
<i>Switching Characteristics</i>										
$t_{DDTLFSE}$	Data Delay from Late External TFSx or External RFSx in multi-channel mode with $MFD = 0^{1,2}$				12.0				ns	
$t_{DTENLFSE}$	Data Enable from External RFSx in multi-channel mode with $MFD = 0^{1,2}$				0.0				ns	

<sup>1</sup>When in multi-channel mode, TFSx enable and TFSx valid follow  $t_{DTENLFSE}$  and  $t_{DDTLFSE}$ .

<sup>2</sup>If external RFSx/TFSx setup to  $RSCLKx/TSCLKx > t_{SCLK}/2$  then  $t_{DDTTE/I}$  and  $t_{DTENE/I}$  apply, otherwise  $t_{DDTLFSE}$  and  $t_{DTENLFSE}$  apply.



Figure 27. Serial Ports — External Late Frame Sync



# ADSP-BF522/ADSP-BF523/ADSP-BF524/ADSP-BF525/ADSP-BF526/ADSP-BF527

## Serial Peripheral Interface (SPI) Port—Master Timing

Table 48 and Figure 28 describe SPI port master operations.

**Table 48. Serial Peripheral Interface (SPI) Port—Master Timing**

Parameter	ADSP-BF522/ADSP-BF524/ ADSP-BF526				ADSP-BF523/ADSP-BF525/ ADSP-BF527				Unit	
	$V_{DDEXT}$ 1.8V Nominal		$V_{DDEXT}$ 2.5 V or 3.3V Nominal		$V_{DDEXT}$ 1.8V Nominal		$V_{DDEXT}$ 2.5 V or 3.3V Nominal			
	Min	Max	Min	Max	Min	Max	Min	Max		
<i>Timing Requirements</i>										
$t_{SSPIDM}$ Data Input Valid to SCK Edge (Data Input Setup)	11.6		9.6		11.6		9.6		ns	
$t_{HSPIDM}$ SCK Sampling Edge to Data Input Invalid	-1.5		-1.5		-1.5		-1.5		ns	
<i>Switching Characteristics</i>										
$t_{SDSCIM}$ $\overline{SPISELx}$ low to First SCK Edge	$2 \times t_{SCLK} - 1.5$		$2 \times t_{SCLK} - 1.5$		$2 \times t_{SCLK} - 1.5$		$2 \times t_{SCLK} - 1.5$		ns	
$t_{SPICHM}$ Serial Clock High Period	$2 \times t_{SCLK} - 1.5$		$2 \times t_{SCLK} - 1.5$		$2 \times t_{SCLK} - 1.5$		$2 \times t_{SCLK} - 1.5$		ns	
$t_{SPICLM}$ Serial Clock Low Period	$2 \times t_{SCLK} - 1.5$		$2 \times t_{SCLK} - 1.5$		$2 \times t_{SCLK} - 1.5$		$2 \times t_{SCLK} - 1.5$		ns	
$t_{SPICLK}$ Serial Clock Period	$4 \times t_{SCLK} - 1.5$		$4 \times t_{SCLK} - 1.5$		$4 \times t_{SCLK} - 1.5$		$4 \times t_{SCLK} - 1.5$		ns	
$t_{HDSM}$ Last SCK Edge to $\overline{SPISELx}$ High	$2 \times t_{SCLK} - 1.5$		$2 \times t_{SCLK} - 1.5$		$2 \times t_{SCLK} - 1.5$		$2 \times t_{SCLK} - 1.5$		ns	
$t_{SPITDM}$ Sequential Transfer Delay	$2 \times t_{SCLK} - 1.5$		$2 \times t_{SCLK} - 1.5$		$2 \times t_{SCLK} - 1.5$		$2 \times t_{SCLK} - 1.5$		ns	
$t_{DDSPIDM}$ SCK Edge to Data Out Valid (Data Out Delay)		6		6		6		6	ns	
$t_{HDSPIDM}$ SCK Edge to Data Out Invalid (Data Out Hold)	-1.0		-1.0		-1.0		-1.0		ns	



Figure 28. Serial Peripheral Interface (SPI) Port—Master Timing

# ADSP-BF522/ADSP-BF523/ADSP-BF524/ADSP-BF525/ADSP-BF526/ADSP-BF527

## Serial Peripheral Interface (SPI) Port—Slave Timing

Table 49 and Figure 29 describe SPI port slave operations.

**Table 49. Serial Peripheral Interface (SPI) Port—Slave Timing**

Parameter	ADSP-BF522/ADSP-BF524/ ADSP-BF526				ADSP-BF523/ADSP-BF525/ ADSP-BF527				Unit		
	$V_{DDEXT}$ 1.8V Nominal		$V_{DDEXT}$ 2.5 V or 3.3 V Nominal		$V_{DDEXT}$ 1.8V Nominal		$V_{DDEXT}$ 2.5 V or 3.3 V Nominal				
	Min	Max	Min	Max	Min	Max	Min	Max			
<i>Timing Requirements</i>											
$t_{SPICHS}$	Serial Clock High Period		$2 \times t_{SCLK} - 1.5$		$2 \times t_{SCLK} - 1.5$		$2 \times t_{SCLK} - 1.5$		$2 \times t_{SCLK} - 1.5$		ns
$t_{SPICLS}$	Serial Clock Low Period		$2 \times t_{SCLK} - 1.5$		$2 \times t_{SCLK} - 1.5$		$2 \times t_{SCLK} - 1.5$		$2 \times t_{SCLK} - 1.5$		ns
$t_{SPICLK}$	Serial Clock Period		$4 \times t_{SCLK} - 1.5$		$4 \times t_{SCLK} - 1.5$		$4 \times t_{SCLK} - 1.5$		$4 \times t_{SCLK} - 1.5$		ns
$t_{HDS}$	Last SCK Edge to $\overline{SPISS}$ Not Asserted		$2 \times t_{SCLK} - 1.5$		$2 \times t_{SCLK} - 1.5$		$2 \times t_{SCLK} - 1.5$		$2 \times t_{SCLK} - 1.5$		ns
$t_{SPITDS}$	Sequential Transfer Delay		$2 \times t_{SCLK} - 1.5$		$2 \times t_{SCLK} - 1.5$		$2 \times t_{SCLK} - 1.5$		$2 \times t_{SCLK} - 1.5$		ns
$t_{SDSCI}$	$\overline{SPISS}$ Assertion to First SCK Edge		$2 \times t_{SCLK} - 1.5$		$2 \times t_{SCLK} - 1.5$		$2 \times t_{SCLK} - 1.5$		$2 \times t_{SCLK} - 1.5$		ns
$t_{SSPID}$	Data Input Valid to SCK Edge (Data Input Setup)		1.6		1.6		1.6		1.6		ns
$t_{HSPID}$	SCK Sampling Edge to Data Input Invalid		2.0		1.6		1.6		1.6		ns
<i>Switching Characteristics</i>											
$t_{DSOE}$	$\overline{SPISS}$ Assertion to Data Out Active		0		12.0		0		12.0		ns
$t_{DSDHI}$	$\overline{SPISS}$ Deassertion to Data High Impedance		0		11.0		0		8		ns
$t_{DDSPID}$	SCK Edge to Data Out Valid (Data Out Delay)				10		10		10		ns
$t_{HDSPID}$	SCK Edge to Data Out Invalid (Data Out Hold)		0		0		0		0		ns



Figure 29. Serial Peripheral Interface (SPI) Port—Slave Timing

# ADSP-BF522/ADSP-BF523/ADSP-BF524/ADSP-BF525/ADSP-BF526/ADSP-BF527

## Universal Serial Bus (USB) On-The-Go—Receive and Transmit Timing

Table 50 describes the USB On-The-Go receive and transmit operations.

**Table 50. USB On-The-Go—Receive and Transmit Timing**

Parameter	ADSP-BF522/ADSP-BF524/ADSP-BF526				ADSP-BF523/ADSP-BF525/ ADSP-BF527				Unit		
	$V_{DDEXT}$ 1.8 V Nominal		$V_{DDEXT}$ 2.5 V or 3.3 V Nominal		$V_{DDEXT}$ 1.8 V Nominal		$V_{DDEXT}$ 2.5 V or 3.3 V Nominal				
	Min	Max	Min	Max	Min	Max	Min	Max			
<i>Timing Requirements</i>											
$f_{USBS}$	USB_XI Frequency		12	33.3	12	33.3	9	33.3	9	33.3	MHz
$FS_{USB}$	USB_XI Clock Frequency Stability		-50	50	-50	50	-50	50	-50	50	ppm

# ADSP-BF522/ADSP-BF523/ADSP-BF524/ADSP-BF525/ADSP-BF526/ADSP-BF527

## Universal Asynchronous Receiver-Transmitter (UART) Ports—Receive and Transmit Timing

For information on the UART port receive and transmit operations, see the *ADSP-BF52x Hardware Reference Manual*.

### General-Purpose Port Timing

Table 51 and Figure 30 describe general-purpose port operations.

**Table 51. General-Purpose Port Timing for ADSP-BF522/ADSP-BF524/ADSP-BF526 Processors**

Parameter	$V_{DDEXT}$ 1.8V Nominal		$V_{DDEXT}$ 2.5 V or 3.3 V Nominal		Unit
	Min	Max	Min	Max	
<i>Timing Requirement</i>					
$t_{WFI}$ General-Purpose Port Ball Input Pulse Width	$t_{SCLK} + 1$		$t_{SCLK} + 1$		ns
<i>Switching Characteristics</i>					
$t_{GPOD}$ General-Purpose Port Ball Output Delay from CLKOUT Low	0	11.0	0	8.2	ns

**Table 52. General-Purpose Port Timing for ADSP-BF523/ADSP-BF525/ADSP-BF527 Processors**

Parameter	$V_{DDEXT}$ 1.8V Nominal		$V_{DDEXT}$ 2.5 V or 3.3 V Nominal		Unit
	Min	Max	Min	Max	
<i>Timing Requirement</i>					
$t_{WFI}$ General-Purpose Port Ball Input Pulse Width	$t_{SCLK} + 1$		$t_{SCLK} + 1$		ns
<i>Switching Characteristics</i>					
$t_{GPOD}$ General-Purpose Port Ball Output Delay from CLKOUT Low	0	8.2	0	6.5	ns



Figure 30. General-Purpose Port Timing

# ADSP-BF522/ADSP-BF523/ADSP-BF524/ADSP-BF525/ADSP-BF526/ADSP-BF527

## Timer Cycle Timing

Table 53 and Figure 31 describe timer expired operations. The input signal is asynchronous in “width capture mode” and “external clock mode” and has an absolute maximum input frequency of ( $f_{SCLK}/2$ ) MHz.

**Table 53. Timer Cycle Timing**

Parameter	ADSP-BF522/ADSP-BF524/ADSP-BF526				ADSP-BF523/ADSP-BF525/ADSP-BF527				Unit
	$V_{DDEXT}$ 1.8 V Nominal		$V_{DDEXT}$ 2.5 V or 3.3 V Nominal		$V_{DDEXT}$ 1.8 V Nominal		$V_{DDEXT}$ 2.5 V or 3.3 V Nominal		
	Min	Max	Min	Max	Min	Max	Min	Max	
<i>Timing Requirements</i>									
$t_{WL}$ Timer Pulse Width Input Low (Measured In SCLK Cycles) <sup>1</sup>	$t_{SCLK}$		$t_{SCLK}$		$t_{SCLK}$		$t_{SCLK}$		ns
$t_{WH}$ Timer Pulse Width Input High (Measured In SCLK Cycles) <sup>1</sup>	$t_{SCLK}$		$t_{SCLK}$		$t_{SCLK}$		$t_{SCLK}$		ns
$t_{TIS}$ Timer Input Setup Time Before CLKOUT Low <sup>2</sup>	10		7		8.1		6.2		ns
$t_{TIH}$ Timer Input Hold Time After CLKOUT Low <sup>2</sup>	-2		-2		-2		-2		ns
<i>Switching Characteristics</i>									
$t_{HTO}$ Timer Pulse Width Output (Measured In SCLK Cycles)	$t_{SCLK} - 1.5$	$(2^{32} - 1)t_{SCLK}$	$t_{SCLK} - 1$	$(2^{32} - 1)t_{SCLK}$	$t_{SCLK} - 1$	$(2^{32} - 1)t_{SCLK}$	$t_{SCLK} - 1$	$(2^{32} - 1)t_{SCLK}$	ns
$t_{TOD}$ Timer Output Update Delay After CLKOUT High		6		6		6		6	ns

<sup>1</sup> The minimum pulse widths apply for TMRx signals in width capture and external clock modes. They also apply to the PF15 or PPI\_CLK signals in PWM output mode.

<sup>2</sup> Either a valid setup and hold time or a valid pulse width is sufficient. There is no need to resynchronize programmable flag inputs.

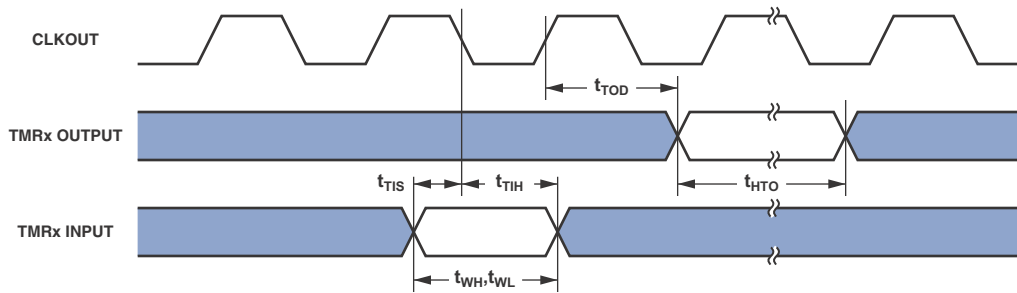

Figure 31. Timer Cycle Timing

# ADSP-BF522/ADSP-BF523/ADSP-BF524/ADSP-BF525/ADSP-BF526/ADSP-BF527

## Timer Clock Timing

Table 54 and Figure 32 describe timer clock timing.

Table 54. Timer Clock Timing

Parameter	$V_{DDEXT}$ 1.8V Nominal		$V_{DDEXT}$ 2.5 V or 3.3 V Nominal		Unit
	Min	Max	Min	Max	
<i>Switching Characteristic</i>					
$t_{TODP}$	Timer Output Update Delay After PPI_CLK High		12.0	12.0	ns

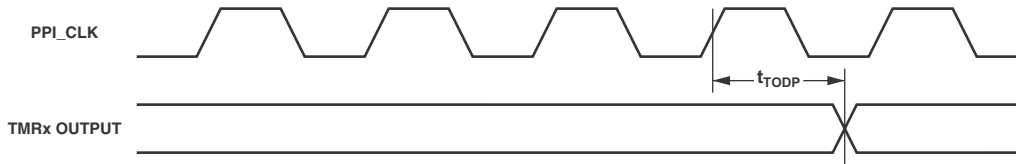

Figure 32. Timer Clock Timing

## Up/Down Counter/Rotary Encoder Timing

Table 55. Up/Down Counter/Rotary Encoder Timing

Parameter	$V_{DDEXT}$ 1.8V Nominal		$V_{DDEXT}$ 2.5 V or 3.3 V Nominal		Unit
	Min	Max	Min	Max	
<i>Timing Requirements</i>					
$t_{WCOUNT}$	Up/Down Counter/Rotary Encoder Input Pulse Width		$t_{SCLK} + 1$	$t_{SCLK} + 1$	ns
$t_{CIS}$	Counter Input Setup Time Before CLKOUT High <sup>1</sup>		9.0	7.0	ns
$t_{CIH}$	Counter Input Hold Time After CLKOUT High <sup>1</sup>		0	0	ns

<sup>1</sup> Either a valid setup and hold time or a valid pulse width is sufficient. There is no need to resynchronize counter inputs.

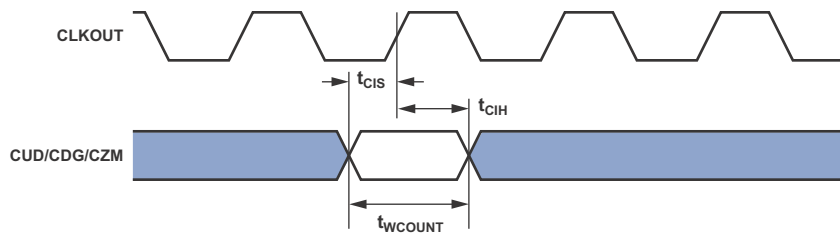

Figure 33. Up/Down Counter/Rotary Encoder Timing

# ADSP-BF522/ADSP-BF523/ADSP-BF524/ADSP-BF525/ADSP-BF526/ADSP-BF527

## HOSTDP A/C Timing- Host Read Cycle

Table 56 describes the HOSTDP A/C Host Read Cycle timing requirements.

**Table 56. Host Read Cycle Timing Requirements**

Parameter	ADSP-BF522/ADSP-BF524/ ADSP-BF526				ADSP-BF523/ADSP-BF525/ ADSP-BF527				Unit
	V <sub>DDEXT</sub> 1.8V Nominal		V <sub>DDEXT</sub> 2.5 V or 3.3 V Nominal		V <sub>DDEXT</sub> 1.8V Nominal		V <sub>DDEXT</sub> 2.5 V or 3.3 V Nominal		
	Min	Max	Min	Max	Min	Max	Min	Max	
<i>Timing Requirements</i>									
t <sub>SADDRDL</sub>	HOST_ADDR and $\overline{\text{HOST\_CE}}$ Setup before $\overline{\text{HOST\_RD}}$ falling edge		4		4		4		ns
t <sub>HADDRDH</sub>	HOST_ADDR and $\overline{\text{HOST\_CE}}$ Hold after $\overline{\text{HOST\_RD}}$ rising edge		2.5		2.5		2.5		ns
t <sub>RDWL</sub>	HOST_RD pulse width low (ACK mode)		t <sub>DRDYRDL</sub> + t <sub>RDYPRD</sub> + t <sub>DRDHRDY</sub>		t <sub>DRDYRDL</sub> + t <sub>RDYPRD</sub> + t <sub>DRDHRDY</sub>		t <sub>DRDYRDL</sub> + t <sub>RDYPRD</sub> + t <sub>DRDHRDY</sub>		ns
t <sub>RDWL</sub>	$\overline{\text{HOST\_RD}}$ pulse width low (INT mode)		1.5 × t <sub>SCLK</sub> + 8.7		1.5 × t <sub>SCLK</sub> + 8.7		1.5 × t <sub>SCLK</sub> + 8.7		ns
t <sub>RDWH</sub>	$\overline{\text{HOST\_RD}}$ pulse width high or time between $\overline{\text{HOST\_RD}}$ rising edge and $\overline{\text{HOST\_WR}}$ falling edge		2 × t <sub>SCLK</sub>		2 × t <sub>SCLK</sub>		2 × t <sub>SCLK</sub>		ns
t <sub>DRDHRDY</sub>	$\overline{\text{HOST\_RD}}$ rising edge delay after HOST_ACK rising edge (ACK mode)		2.0		0		0		ns
<i>Switching Characteristics</i>									
t <sub>SDATRDY</sub>	Data valid prior HOST_ACK rising edge (ACK mode)		4.5		3.5		4.5		ns
t <sub>DRDYRDL</sub>	Host_ACK falling edge after $\overline{\text{HOST\_CE}}$ (ACK mode)		12.5		11.25		11.25		ns
t <sub>RDYPRD</sub>	HOST_ACK low pulse-width for Read access (ACK mode)		NM <sup>1</sup>		NM <sup>1</sup>		NM <sup>1</sup>		ns
t <sub>DDARWH</sub>	Data disable after $\overline{\text{HOST\_RD}}$		11.0		9.0		9.0		ns
t <sub>ACC</sub>	Data valid after $\overline{\text{HOST\_RD}}$ falling edge (INT mode)		1.5 × t <sub>SCLK</sub>		1.5 × t <sub>SCLK</sub>		1.5 × t <sub>SCLK</sub>		ns
t <sub>HDARWH</sub>	Data hold after $\overline{\text{HOST\_RD}}$ rising edge		1.0		1.0		1.0		ns

<sup>1</sup> NM (Not Measured) — This parameter is based on t<sub>SCLK</sub>. It is not measured because the number of SCLK cycles for which HOST\_ACK is low depends on the Host DMA FIFO status and is system design dependent.



In Figure 34, HOST\_DATA is HOST\_D0-D15.

Figure 34. HOSTDP A/C-Host Read Cycle



# ADSP-BF522/ADSP-BF523/ADSP-BF524/ADSP-BF525/ADSP-BF526/ADSP-BF527

## HOSTDP A/C Timing- Host Write Cycle

Table 57 describes the HOSTDP A/C Host Write Cycle timing requirements.

**Table 57. Host Write Cycle Timing Requirements**

Parameter	ADSP-BF522/ADSP-BF524/ ADSP-BF526				ADSP-BF523/ADSP-BF525/ ADSP-BF527				Unit
	$V_{DDEXT}$ 1.8V Nominal		$V_{DDEXT}$ 2.5 V or 3.3V Nominal		$V_{DDEXT}$ 1.8V Nominal		$V_{DDEXT}$ 2.5 V or 3.3V Nominal		
	Min	Max	Min	Max	Min	Max	Min	Max	
<i>Timing Requirements</i>									
$t_{SADWRL}$ HOST_ADDR/HOST_CE Setup before HOST_WR falling edge	4		4		4		4		ns
$t_{HADWRH}$ HOST_ADDR/HOST_CE Hold after HOST_WR rising edge	2.5		2.5		2.5		2.5		ns
$t_{WRWL}$ HOST_WR pulse width low (ACK mode)	$t_{DRDYWRL} + t_{RDYPRD} + t_{DWRHRDY}$		$t_{DRDYWRL} + t_{RDYPRD} + t_{DWRHRDY}$		$t_{DRDYWRL} + t_{RDYPRD} + t_{DWRHRDY}$		$t_{DRDYWRL} + t_{RDYPRD} + t_{DWRHRDY}$		ns
HOST_WR pulse width low (INT mode)	$1.5 \times t_{SCLK} + 8.7$		$1.5 \times t_{SCLK} + 8.7$		$1.5 \times t_{SCLK} + 8.7$		$1.5 \times t_{SCLK} + 8.7$		ns
$t_{WRWH}$ HOST_WR pulse width high or time between HOST_WR rising edge and HOST_RD falling edge	$2 \times t_{SCLK}$		$2 \times t_{SCLK}$		$2 \times t_{SCLK}$		$2 \times t_{SCLK}$		ns
$t_{DWRHRDY}$ HOST_WR rising edge delay after HOST_ACK rising edge (ACK mode)	2.0		2.0		0		0		ns
$t_{HDATWH}$ Data Hold after HOST_WR rising edge	2.5		2.5		2.5		2.5		ns
$t_{SDATWH}$ Data Setup before HOST_WR rising edge	3.5		2.5		2.5		2.5		ns
<i>Switching Characteristics</i>									
$t_{DRDYWRL}$ HOST_ACK falling edge after HOST_CE asserted (ACK mode)		12.5		11.5		11.5		11.5	ns
$t_{RDYPWR}$ HOST_ACK low pulse-width for Write access (ACK mode)		NM <sup>1</sup>		NM <sup>1</sup>		NM <sup>1</sup>		NM <sup>1</sup>	ns

<sup>1</sup> NM (Not Measured) — This parameter is based on  $t_{SCLK}$ . It is not measured because the number of SCLK cycles for which HOST\_ACK is low depends on the Host DMA FIFO status and is system design dependent.



In Figure 35, HOST\_DATA is HOST\_D0-D15.

Figure 35. HOSTDP A/C- Host Write Cycle

# ADSP-BF522/ADSP-BF523/ADSP-BF524/ADSP-BF525/ADSP-BF526/ADSP-BF527

## 10/100 Ethernet MAC Controller Timing

Table 58 through Table 63 and Figure 36 through Figure 41 describe the 10/100 Ethernet MAC Controller operations.

**Table 58. 10/100 Ethernet MAC Controller Timing: MII Receive Signal**

Parameter <sup>1</sup>	V <sub>DDEXT</sub> 1.8V Nominal		V <sub>DDEXT</sub> 2.5 V or 3.3V Nominal		Unit
	Min	Max	Min	Max	
<i>Timing Requirements</i>					
t <sub>ERXCLKF</sub>	ERxCLK Frequency (f <sub>SCLK</sub> = SCLK Frequency)		None	25 + 1%	MHz
t <sub>ERXCLKW</sub>	ERxCLK Width (t <sub>ERXCLK</sub> = ERxCLK Period)		t <sub>ERXCLK</sub> × 40%	t <sub>ERXCLK</sub> × 60%	ns
t <sub>ERXCLKIS</sub>	Rx Input Valid to ERxCLK Rising Edge (Data In Setup)		7.5	7.5	ns
t <sub>ERXCLKIH</sub>	ERxCLK Rising Edge to Rx Input Invalid (Data In Hold)		7.5	7.5	ns

<sup>1</sup> MII inputs synchronous to ERxCLK are ERxD3–0, ERxDV, and ERxER.



Figure 36. 10/100 Ethernet MAC Controller Timing: MII Receive Signal

**Table 59. 10/100 Ethernet MAC Controller Timing: MII Transmit Signal**

Parameter <sup>1</sup>	V <sub>DDEXT</sub> 1.8V Nominal		V <sub>DDEXT</sub> 2.5 V or 3.3V Nominal		Unit
	Min	Max	Min	Max	
<i>Switching Characteristics</i>					
t <sub>ETXCLKF</sub>	ETxCLK Frequency (f <sub>SCLK</sub> = SCLK Frequency)		None	25 + 1%	MHz
t <sub>ETXCLKW</sub>	ETxCLK Width (t <sub>ETXCLK</sub> = ETxCLK Period)		t <sub>ETXCLK</sub> × 40%	t <sub>ETXCLK</sub> × 60%	ns
t <sub>ETXCLKOV</sub>	ETxCLK Rising Edge to Tx Output Valid (Data Out Valid)		0	20	ns
t <sub>ETXCLKOH</sub>	ETxCLK Rising Edge to Tx Output Invalid (Data Out Hold)		0	0	ns

<sup>1</sup> MII outputs synchronous to ETxCLK are ETxD3–0.

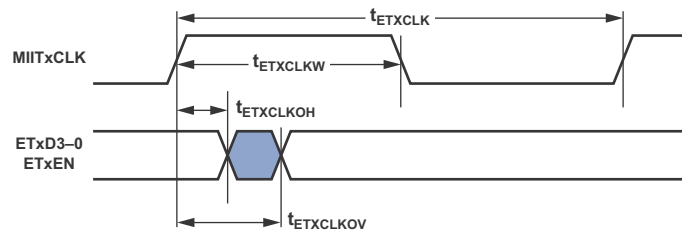

Figure 37. 10/100 Ethernet MAC Controller Timing: MII Transmit Signal

# ADSP-BF522/ADSP-BF523/ADSP-BF524/ADSP-BF525/ADSP-BF526/ADSP-BF527

**Table 60. 10/100 Ethernet MAC Controller Timing: RMI Receive Signal**

Parameter <sup>1</sup>	V <sub>DDEXT</sub> 1.8V Nominal		V <sub>DDEXT</sub> 2.5 V or 3.3V Nominal		Unit
	Min	Max	Min	Max	
<i>Timing Requirements</i>					
t <sub>REFCLKF</sub>	None		50 + 1%		MHz
t <sub>REFCLKW</sub>	t <sub>REFCLK</sub> × 40%		t <sub>REFCLK</sub> × 60%		ns
t <sub>REFCLKIS</sub>	4		4		ns
t <sub>REFCLKIH</sub>	2		2		ns

<sup>1</sup> RMI inputs synchronous to RMI REF\_CLK are ERxD1-0, RMI CRS\_DV, and ERxER.



Figure 38. 10/100 Ethernet MAC Controller Timing: RMI Receive Signal

**Table 61. 10/100 Ethernet MAC Controller Timing: RMI Transmit Signal**

Parameter <sup>1</sup>	ADSP-BF522/ADSP-BF524/ ADSP-BF526				ADSP-BF523/ADSP-BF525/ ADSP-BF527				Unit	
	V <sub>DDEXT</sub> 1.8V Nominal		V <sub>DDEXT</sub> 2.5 V or 3.3V Nominal		V <sub>DDEXT</sub> 1.8V Nominal		V <sub>DDEXT</sub> 2.5 V or 3.3V Nominal			
	Min	Max	Min	Max	Min	Max	Min	Max		
<i>Switching Characteristics</i>										
t <sub>REFCLKOV</sub>	8.1		8.1		7.5		7.5		ns	
t <sub>REFCLKOH</sub>	2		2		2		2		ns	

<sup>1</sup> RMI outputs synchronous to RMI REF\_CLK are ETxD1-0.

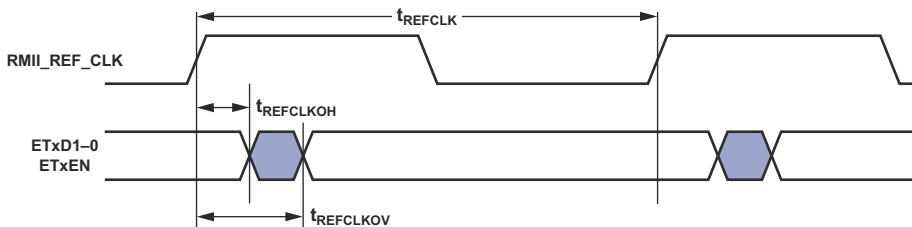

Figure 39. 10/100 Ethernet MAC Controller Timing: RMI Transmit Signal

# ADSP-BF522/ADSP-BF523/ADSP-BF524/ADSP-BF525/ADSP-BF526/ADSP-BF527

**Table 62. 10/100 Ethernet MAC Controller Timing: MII/RMII Asynchronous Signal**

Parameter	$V_{DDEXT}$ 1.8V Nominal		$V_{DDEXT}$ 2.5 V or 3.3V Nominal		Unit
	Min	Max	Min	Max	
<i>Timing Requirements</i>					
$t_{ECOLH}$	COL Pulse Width High <sup>1</sup>		$t_{ETxCLK} \times 1.5$ $t_{ERxCLK} \times 1.5$	$t_{ETxCLK} \times 1.5$ $t_{ERxCLK} \times 1.5$	ns
$t_{ECOLL}$	COL Pulse Width Low <sup>1</sup>		$t_{ETxCLK} \times 1.5$ $t_{ERxCLK} \times 1.5$	$t_{ETxCLK} \times 1.5$ $t_{ERxCLK} \times 1.5$	ns
$t_{ECRSH}$	CRS Pulse Width High <sup>2</sup>		$t_{ETxCLK} \times 1.5$	$t_{ETxCLK} \times 1.5$	ns
$t_{ECRSL}$	CRS Pulse Width Low <sup>2</sup>		$t_{ETxCLK} \times 1.5$	$t_{ETxCLK} \times 1.5$	ns

<sup>1</sup> MII/RMII asynchronous signals are COL and CRS. These signals are applicable in both MII and RMII modes. The asynchronous COL input is synchronized separately to both the ETxCLK and the ERxCLK, and the COL input must have a minimum pulse width high or low at least 1.5 times the period of the slower of the two clocks.

<sup>2</sup> The asynchronous CRS input is synchronized to the ETxCLK, and the CRS input must have a minimum pulse width high or low at least 1.5 times the period of ETxCLK.

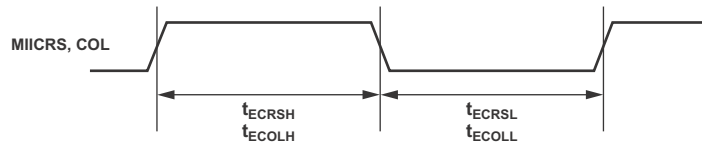

Figure 40. 10/100 Ethernet MAC Controller Timing: Asynchronous Signal

**Table 63. 10/100 Ethernet MAC Controller Timing: MII Station Management**

Parameter <sup>1</sup>	ADSP-BF522/ADSP-BF524/ ADSP-BF526				ADSP-BF523/ADSP-BF525/ ADSP-BF527				Unit	
	$V_{DDEXT}$ 1.8V Nominal		$V_{DDEXT}$ 2.5 V or 3.3V Nominal		$V_{DDEXT}$ 1.8V Nominal		$V_{DDEXT}$ 2.5 V or 3.3V Nominal			
	Min	Max	Min	Max	Min	Max	Min	Max		
<i>Timing Requirements</i>										
$t_{MDIOS}$	MDIO Input Valid to MDC Rising Edge (Setup)		11.5	11.5	10	10	10	10	ns	
$t_{MDCIH}$	MDC Rising Edge to MDIO Input Invalid (Hold)		11.5	11.5	10	10	10	10	ns	
<i>Switching Characteristics</i>										
$t_{MDCOV}$	MDC Falling Edge to MDIO Output Valid			25		25		25	ns	
$t_{MDCOH}$	MDC Falling Edge to MDIO Output Invalid (Hold)		-1	-1	-1	-1	-1	-1	ns	

<sup>1</sup> MDC/MDIO is a 2-wire serial bidirectional port for controlling one or more external PHYs. MDC is an output clock whose minimum period is programmable as a multiple of the system clock SCLK. MDIO is a bidirectional data line.

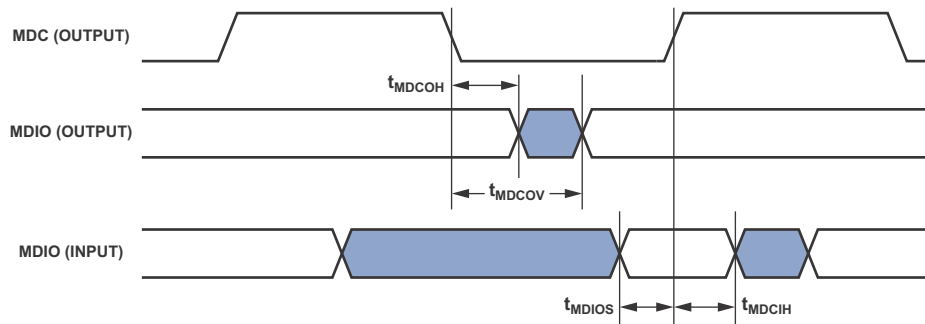

Figure 41. 10/100 Ethernet MAC Controller Timing: MII Station Management

# ADSP-BF522/ADSP-BF523/ADSP-BF524/ADSP-BF525/ADSP-BF526/ADSP-BF527

## JTAG Test And Emulation Port Timing

Table 64 and Figure 42 describe JTAG port operations.

**Table 64. JTAG Port Timing**

Parameter	$V_{DDEXT}$ 1.8V Nominal		$V_{DDEXT}$ 2.5 V or 3.3V Nominal		Unit
	Min	Max	Min	Max	
<i>Timing Requirements</i>					
$t_{TCK}$	TCK Period		20	20	ns
$t_{STAP}$	TDI, TMS Setup Before TCK High		4	4	ns
$t_{HTAP}$	TDI, TMS Hold After TCK High		4	4	ns
$t_{SSYS}$	System Inputs Setup Before TCK High <sup>1</sup>		12	12	ns
$t_{HSYS}$	System Inputs Hold After TCK High <sup>1</sup>		5	5	ns
$t_{TRSTW}$	$\overline{TRST}$ Pulse Width <sup>2</sup> (measured in TCK cycles)		4	4	TCK
<i>Switching Characteristics</i>					
$t_{DTDO}$	TDO Delay from TCK Low			10	ns
$t_{DSYS}$	System Outputs Delay After TCK Low <sup>3</sup>			12	ns

<sup>1</sup> System Inputs = DATA15-0, ARDY, SCL, SDA, PF15-0, PG15-0, PH15-0,  $\overline{RESET}$ ,  $\overline{NMI}$ , BMODE3-0.

<sup>2</sup> 50 MHz Maximum

<sup>3</sup> System Outputs = DATA15-0, ADDR19-1,  $\overline{ABE1-0}$ ,  $\overline{AOE}$ ,  $\overline{ARE}$ ,  $\overline{AWE}$ ,  $\overline{AMS3-0}$ ,  $\overline{SRAS}$ ,  $\overline{SCAS}$ ,  $\overline{SWE}$ ,  $\overline{SCKE}$ , CLKOUT, SA10,  $\overline{SMS}$ , SCL, SDA, PF15-0, PG15-0, PH15-0.



Figure 42. JTAG Port Timing

## OUTPUT DRIVE CURRENTS

Figure 43 through Figure 57 show typical current-voltage characteristics for the output drivers of the ADSP-BF52x processors.

The curves represent the current drive capability of the output drivers. See Table 10 on Page 22 for information about which driver type corresponds to a particular ball.



Figure 43. Driver Type A Current ( $3.3V_{DDEXT}/V_{DDMEM}$ )



Figure 46. Driver Type B Current ( $3.3V_{DDEXT}/V_{DDMEM}$ )

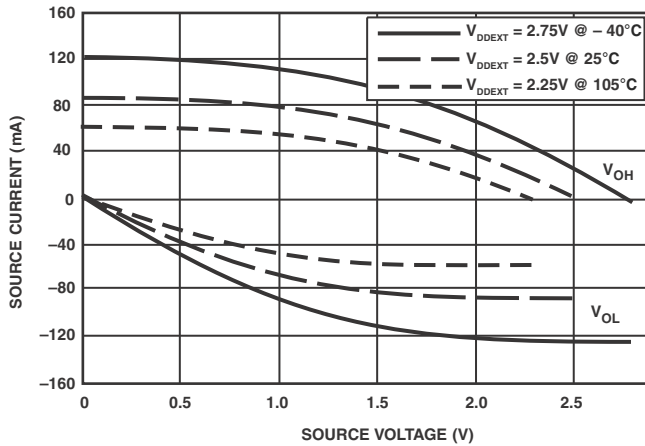

Figure 44. Driver Type A Current ( $2.5V_{DDEXT}/V_{DDMEM}$ )



Figure 47. Driver Type B Current ( $2.5V_{DDEXT}/V_{DDMEM}$ )



Figure 45. Driver Type A Current ( $1.8V_{DDEXT}/V_{DDMEM}$ )



Figure 48. Driver Type B Current ( $1.8V_{DDEXT}/V_{DDMEM}$ )



# ADSP-BF522/ADSP-BF523/ADSP-BF524/ADSP-BF525/ADSP-BF526/ADSP-BF527



Figure 49. Driver Type C Current ( $3.3V V_{DDEXT}/V_{DDMEM}$ )



Figure 52. Driver Type D Current ( $3.3V V_{DDEXT}/V_{DDMEM}$ )



Figure 50. Drive Type C Current ( $2.5V V_{DDEXT}/V_{DDMEM}$ )



Figure 53. Driver Type D Current ( $2.5V V_{DDEXT}/V_{DDMEM}$ )



Figure 51. Driver Type C Current ( $1.8V V_{DDEXT}/V_{DDMEM}$ )



Figure 54. Driver Type D Current ( $1.8V V_{DDEXT}/V_{DDMEM}$ )

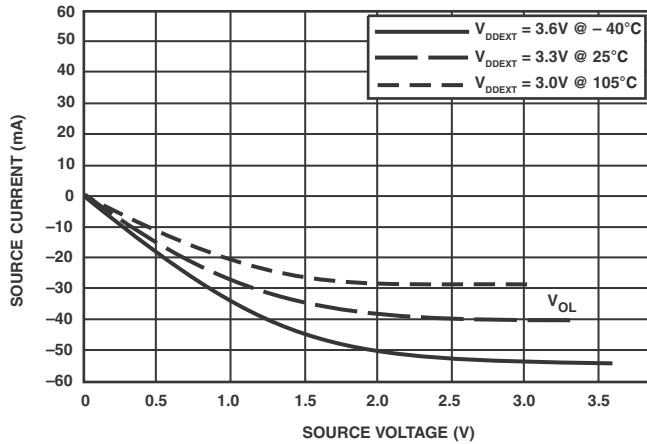

Figure 55. Driver Type E Current ( $3.3V V_{DDEXT}/V_{DDMEM}$ )



Figure 56. Driver Type E Current ( $2.5V V_{DDEXT}/V_{DDMEM}$ )



Figure 57. Driver Type E Current ( $1.8V V_{DDEXT}/V_{DDMEM}$ )

## TEST CONDITIONS

All Timing Requirements appearing in this data sheet were measured under the conditions described in this section.

Figure 58 shows the measurement point for AC measurements (except output enable/disable). The measurement point  $V_{MEAS}$  is  $V_{DDEXT}/2$  or  $V_{DDMEM}/2$  for  $V_{DDEXT}/V_{DDMEM}$  (nominal) = 1.8 V/2.5 V/3.3 V.



Figure 58. Voltage Reference Levels for AC Measurements (Except Output Enable/Disable)

## Output Enable Time Measurement

Output balls are considered to be enabled when they have made a transition from a high impedance state to the point when they start driving.

The output enable time  $t_{ENA}$  is the interval from the point when a reference signal reaches a high or low voltage level to the point when the output starts driving as shown on the right side of Figure 59.

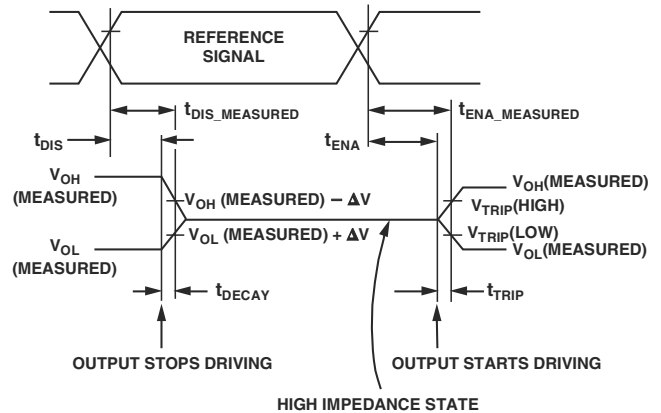

Figure 59. Output Enable/Disable

The time  $t_{ENA\_MEASURED}$  is the interval from when the reference signal switches to when the output voltage reaches  $V_{TRIP}(high)$  or  $V_{TRIP}(low)$ . For  $V_{DDEXT}/V_{DDMEM}$  (nominal) = 1.8 V,  $V_{TRIP}(high)$  is 1.05 V, and  $V_{TRIP}(low)$  is 0.75 V. For  $V_{DDEXT}/V_{DDMEM}$  (nominal) = 2.5 V,  $V_{TRIP}(high)$  is 1.5 V and  $V_{TRIP}(low)$  is 1.0 V. For  $V_{DDEXT}/V_{DDMEM}$  (nominal) = 3.3 V,  $V_{TRIP}(high)$  is 1.9 V, and  $V_{TRIP}(low)$  is 1.4 V. Time  $t_{TRIP}$  is the interval from when the output starts driving to when the output reaches the  $V_{TRIP}(high)$  or  $V_{TRIP}(low)$  trip voltage.

Time  $t_{ENA}$  is calculated as shown in the equation:

$$t_{ENA} = t_{ENA\_MEASURED} - t_{TRIP}$$

If multiple balls (such as the data bus) are enabled, the measurement value is that of the first ball to start driving.

## Output Disable Time Measurement

Output balls are considered to be disabled when they stop driving, go into a high impedance state, and start to decay from their output high or low voltage. The output disable time  $t_{DIS}$  is the difference between  $t_{DIS\_MEASURED}$  and  $t_{DECAY}$  as shown on the left side of Figure 59.

$$t_{DIS} = t_{DIS\_MEASURED} - t_{DECAY}$$

The time for the voltage on the bus to decay by  $\Delta V$  is dependent on the capacitive load  $C_L$  and the load current  $I_L$ . This decay time can be approximated by the equation:

$$t_{DECAY} = (C_L \Delta V) / I_L$$

The time  $t_{DECAY}$  is calculated with test loads  $C_L$  and  $I_L$ , and with  $\Delta V$  equal to 0.25 V for  $V_{DDEXT}/V_{DDMEM}$  (nominal) = 2.5 V/3.3 V and 0.15 V for  $V_{DDEXT}/V_{DDMEM}$  (nominal) = 1.8V.

The time  $t_{DIS\_MEASURED}$  is the interval from when the reference signal switches, to when the output voltage decays  $\Delta V$  from the measured output high or output low voltage.

### Example System Hold Time Calculation

To determine the data output hold time in a particular system, first calculate  $t_{DECAY}$  using the equation given above. Choose  $\Delta V$  to be the difference between the processor's output voltage and the input threshold for the device requiring the hold time.  $C_L$  is the total bus capacitance (per data line), and  $I_L$  is the total leakage or three-state current (per data line). The hold time will be  $t_{DECAY}$  plus the various output disable times as specified in the Timing Specifications on Page 38 (for example  $t_{DSDAT}$  for an SDRAM write cycle as shown in SDRAM Interface Timing on Page 46).

### Capacitive Loading

Output delays and holds are based on standard capacitive loads of an average of 6 pF on all balls (see Figure 60).  $V_{LOAD}$  is equal to  $(V_{DDEXT}/V_{DDMEM}) / 2$ . The graphs of Figure 61 through Figure 72 show how output rise time varies with capacitance. The delay and hold specifications given should be derated by a factor derived from these figures. The graphs in these figures may not be linear outside the ranges shown.



NOTES:  
THE WORST CASE TRANSMISSION LINE DELAY IS SHOWN AND CAN BE USED FOR THE OUTPUT TIMING ANALYSIS TO REFLECT THE TRANSMISSION LINE EFFECT AND MUST BE CONSIDERED. THE TRANSMISSION LINE (TD) IS FOR LOAD ONLY AND DOES NOT AFFECT THE DATA SHEET TIMING SPECIFICATIONS.

ANALOG DEVICES RECOMMENDS USING THE IBIS MODEL TIMING FOR A GIVEN SYSTEM REQUIREMENT. IF NECESSARY, A SYSTEM MAY INCORPORATE EXTERNAL DRIVERS TO COMPENSATE FOR ANY TIMING DIFFERENCES.

Figure 60. Equivalent Device Loading for AC Measurements (Includes All Fixtures)



Figure 61. Driver Type A Typical Rise and Fall Times (10%–90%) vs. Load Capacitance (1.8V  $V_{DDEXT}/V_{DDMEM}$ )

# ADSP-BF522/ADSP-BF523/ADSP-BF524/ADSP-BF525/ADSP-BF526/ADSP-BF527



Figure 62. Driver Type A Typical Rise and Fall Times (10%–90%) vs. Load Capacitance ( $2.5V V_{DDEXT}/V_{DDMEM}$ )



Figure 65. Driver Type B Typical Rise and Fall Times (10%–90%) vs. Load Capacitance ( $2.5V V_{DDEXT}/V_{DDMEM}$ )



Figure 63. Driver Type A Typical Rise and Fall Times (10%–90%) vs. Load Capacitance ( $3.3V V_{DDEXT}/V_{DDMEM}$ )



Figure 66. Driver Type B Typical Rise and Fall Times (10%–90%) vs. Load Capacitance ( $3.3V V_{DDEXT}/V_{DDMEM}$ )



Figure 64. Driver Type B Typical Rise and Fall Times (10%–90%) vs. Load Capacitance ( $1.8V V_{DDEXT}/V_{DDMEM}$ )



Figure 67. Driver Type C Typical Rise and Fall Times (10%–90%) vs. Load Capacitance ( $1.8V V_{DDEXT}/V_{DDMEM}$ )

# ADSP-BF522/ADSP-BF523/ADSP-BF524/ADSP-BF525/ADSP-BF526/ADSP-BF527



Figure 68. Driver Type C Typical Rise and Fall Times (10%–90%) vs. Load Capacitance ( $2.5V V_{DDEXT}/V_{DDMEM}$ )

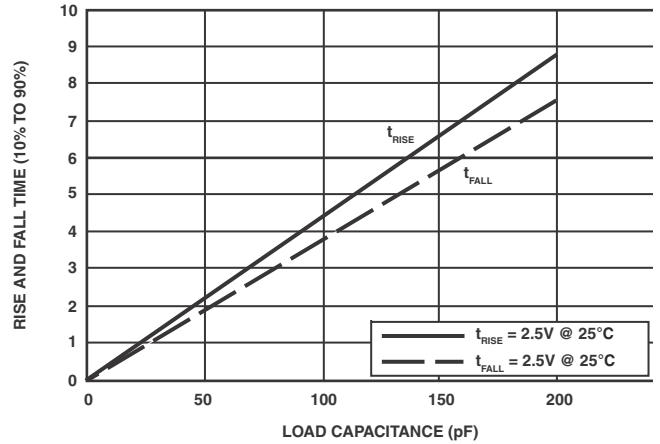

Figure 71. Driver Type D Typical Rise and Fall Times (10%–90%) vs. Load Capacitance ( $2.5V V_{DDEXT}/V_{DDMEM}$ )



Figure 69. Driver Type C Typical Rise and Fall Times (10%–90%) vs. Load Capacitance ( $3.3V V_{DDEXT}/V_{DDMEM}$ )

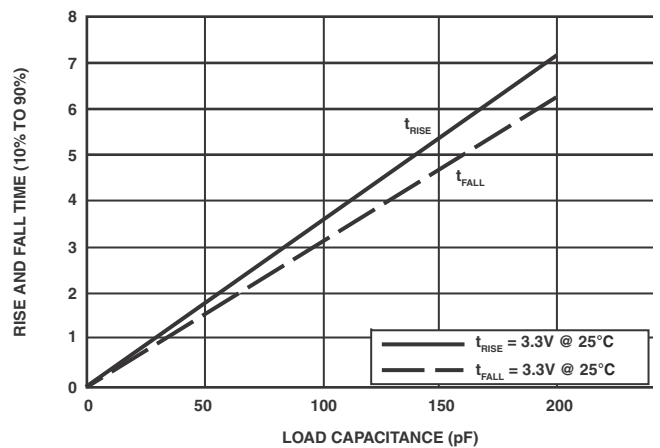

Figure 72. Driver Type D Typical Rise and Fall Times (10%–90%) vs. Load Capacitance ( $3.3V V_{DDEXT}/V_{DDMEM}$ )



Figure 70. Driver Type D Typical Rise and Fall Times (10%–90%) vs. Load Capacitance ( $1.8V V_{DDEXT}/V_{DDMEM}$ )

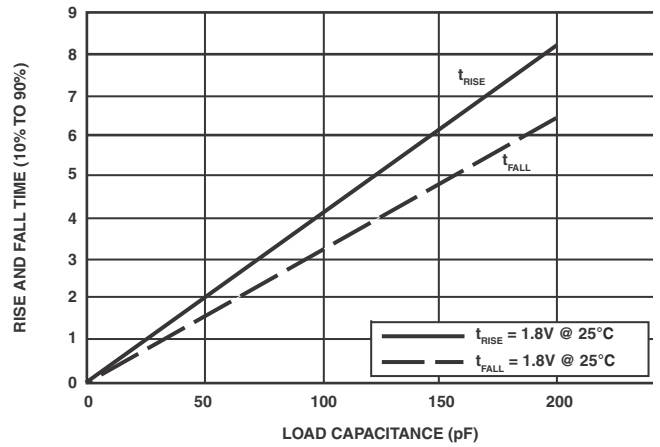

Figure 73. Driver Type G Typical Rise and Fall Times (10%–90%) vs. Load Capacitance ( $1.8V V_{DDEXT}/V_{DDMEM}$ )

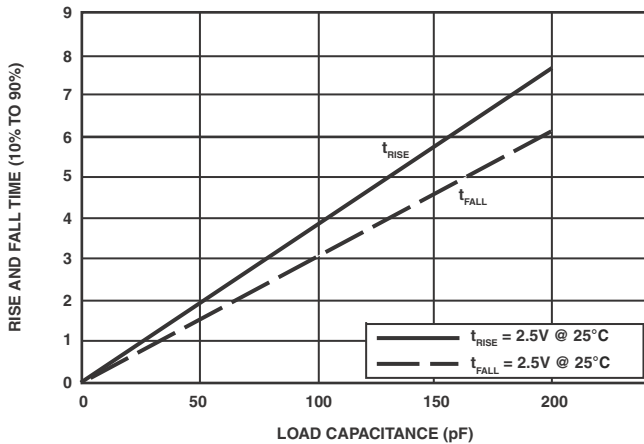

Figure 74. Driver Type G Typical Rise and Fall Times (10%–90%) vs. Load Capacitance (2.5V  $V_{DDEXT}/V_{DDMEM}$ )

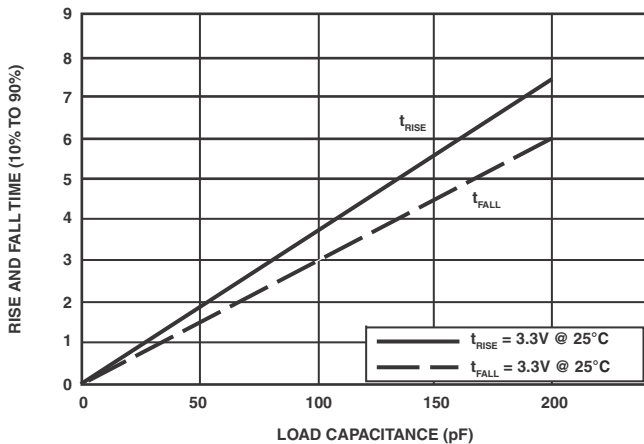

Figure 75. Driver Type G Typical Rise and Fall Times (10%–90%) vs. Load Capacitance (3.3V  $V_{DDEXT}/V_{DDMEM}$ )

## ENVIRONMENTAL CONDITIONS

To determine the junction temperature on the application printed circuit board use:

$$T_J = T_{CASE} + (\Psi_{JT} \times P_D)$$

where:

$T_J$  = Junction temperature (°C)

$T_{CASE}$  = Case temperature (°C) measured by customer at top center of package.

$\Psi_{JT}$  = From Table 66

$P_D$  = Power dissipation — For a description, see [Total Power Dissipation on Page 34](#).

Values of  $\theta_{JA}$  are provided for package comparison and printed circuit board design considerations.  $\theta_{JA}$  can be used for a first order approximation of  $T_J$  by the equation:

$$T_J = T_A + (\theta_{JA} \times P_D)$$

where:

$T_A$  = Ambient temperature (°C)

Values of  $\theta_{JC}$  are provided for package comparison and printed circuit board design considerations when an external heat sink is required.

Values of  $\theta_{JB}$  are provided for package comparison and printed circuit board design considerations.

In [Table 66](#), airflow measurements comply with JEDEC standards JESD51-2 and JESD51-6, and the junction-to-board measurement complies with JESD51-8. The junction-to-case measurement complies with MIL-STD-883 (Method 1012.1). All measurements use a 2S2P JEDEC test board.

Table 65. Thermal Characteristics for BC-208-1 Package

Parameter	Condition	Typical	Unit
$\theta_{JA}$	0 linear m/s air flow	23.20	°C/W
$\theta_{JMA}$	1 linear m/s air flow	20.20	°C/W
$\theta_{JMA}$	2 linear m/s air flow	19.20	°C/W
$\theta_{JB}$		13.05	°C/W
$\theta_{JC}$		6.92	°C/W
$\Psi_{JT}$	0 linear m/s air flow	0.18	°C/W
$\Psi_{JT}$	1 linear m/s air flow	0.27	°C/W
$\Psi_{JT}$	2 linear m/s air flow	0.32	°C/W

Table 66. Thermal Characteristics for BC-289-2 Package

Parameter	Condition	Typical	Unit
$\theta_{JA}$	0 linear m/s air flow	34.5	°C/W
$\theta_{JMA}$	1 linear m/s air flow	31.1	°C/W
$\theta_{JMA}$	2 linear m/s air flow	29.8	°C/W
$\theta_{JB}$		20.3	°C/W
$\theta_{JC}$		8.8	°C/W
$\Psi_{JT}$	0 linear m/s air flow	0.24	°C/W
$\Psi_{JT}$	1 linear m/s air flow	0.44	°C/W
$\Psi_{JT}$	2 linear m/s air flow	0.53	°C/W

# ADSP-BF522/ADSP-BF523/ADSP-BF524/ADSP-BF525/ADSP-BF526/ADSP-BF527

## 289-BALL CSP\_BGA BALL ASSIGNMENT

Table 67 lists the CSP\_BGA balls by signal mnemonic.

Table 68 on Page 80 lists the CSP\_BGA by ball number.

**Table 67. 289-Ball CSP\_BGA Ball Assignment (Alphabetically by Signal)**

Signal	Ball No.	Signal	Ball No.	Signal	Ball No.	Signal	Ball No.	Signal	Ball No.	Signal	Ball No.	Signal	Ball No.
ABE0/SDQM0	AB9	DATA6	T2	GND	M10	NC	D23	PH0	A11	USB_XO	AA23	V <sub>DDINT</sub>	R8
ABE1/SDQM1	AC9	DATA7	T1	GND	M11	NC	E22	PH1	A12	V <sub>DDEXT</sub>	G7	V <sub>DDINT</sub>	R16
ADDR1	AB8	DATA8	R1	GND	M12	NC	E23	PH2	A13	V <sub>DDEXT</sub>	G8	V <sub>DDINT</sub>	T8
ADDR2	AC8	DATA9	P1	GND	M13	NC	F22	PH3	B14	V <sub>DDEXT</sub>	G9	V <sub>DDINT</sub>	T9
ADDR3	AB7	DATA10	P2	GND	M14	NC	F23	PH4	A14	V <sub>DDEXT</sub>	G10	V <sub>DDINT</sub>	T10
ADDR4	AC7	DATA11	R2	GND	M15	NC	G22	PH5	K23	V <sub>DDEXT</sub>	G11	V <sub>DDINT</sub>	T11
ADDR5	AC6	DATA12	N1	GND	N9	NC	H23	PH6	K22	V <sub>DDEXT</sub>	G12	V <sub>DDINT</sub>	T12
ADDR6	AB6	DATA13	N2	GND	N10	NC	J23	PH7	L23	V <sub>DDEXT</sub>	G13	V <sub>DDINT</sub>	T13
ADDR7	AB4	DATA14	M2	GND	N11	NMI	U22	PH8	L22	V <sub>DDEXT</sub>	G14	V <sub>DDINT</sub>	T14
ADDR8	AB5	DATA15	M1	GND	N12	VPPOTP	AB11	PH9	T23	V <sub>DDEXT</sub>	G15	V <sub>DDINT</sub>	T15
ADDR9	AC5	EMU	J2	GND	N13	PF0	A7	PH10	M22	V <sub>DDEXT</sub>	H7	V <sub>DDINT</sub>	T16
ADDR10	AC4	EXT_WAKE0	AC19	GND	N14	PF1	B8	PH11	R22	V <sub>DDEXT</sub>	J17	V <sub>DDMEM</sub>	J7
ADDR11	AB3	GND	A1	GND	N15	PF2	A8	PH12	M23	V <sub>DDEXT</sub>	K17	V <sub>DDMEM</sub>	K7
ADDR12	AC3	GND	A23	GND	P9	PF3	B9	PH13	N22	V <sub>DDEXT</sub>	L17	V <sub>DDMEM</sub>	L7
ADDR13	AB2	GND	B6	GND	P10	PF4	B11	PH14	N23	V <sub>DDEXT</sub>	M17	V <sub>DDMEM</sub>	M7
ADDR14	AC2	GND <sup>1</sup>	G16	GND	P11	PF5	B10	PH15	P22	V <sub>DDEXT</sub>	N17	V <sub>DDMEM</sub>	N7
ADDR15	AA2	GND	G17	GND	P12	PF6	B12	PPI_CLK/TMRCLK	A6	V <sub>DDEXT</sub>	P17	V <sub>DDMEM</sub>	P7
ADDR16	W2	GND <sup>1</sup>	H17	GND	P13	PF7	B13	PPI_FS1/TMR0	B7	V <sub>DDEXT</sub>	R17	V <sub>DDMEM</sub>	R7
ADDR17	Y2	GND	H22	GND	P14	PF8	B16	RESET	V22	V <sub>DDEXT</sub>	T17	V <sub>DDMEM</sub>	T7
ADDR18	AA1	GND <sup>1</sup>	J22	GND	P15	PF9	A20	RTXI	U23	V <sub>DDEXT</sub>	U17	V <sub>DDMEM</sub>	U7
ADDR19	AB1	GND	J9	GND	R9	PF10	B15	RTXO	V23	V <sub>DDINT</sub>	B5	V <sub>DDMEM</sub>	U8
AMS0	AC17	GND	J10	GND	R10	PF11	B17	SA10	AC10	V <sub>DDINT</sub>	H8	V <sub>DDMEM</sub>	U9
AMS1	AB16	GND	J11	GND	R11	PF12	B18	SCAS	AC11	V <sub>DDINT</sub>	H9	V <sub>DDMEM</sub>	U10
AMS2	AC16	GND	J12	GND	R12	PF13	B19	SCKE	AB13	V <sub>DDINT</sub>	H10	V <sub>DDMEM</sub>	U11
AMS3	AB15	GND	J13	GND	R13	PF14	A9	SCL	B22	V <sub>DDINT</sub>	H11	V <sub>DDMEM</sub>	U12
AOE	AC15	GND	J14	GND	R14	PF15	A10	SDA	C22	V <sub>DDINT</sub>	H12	V <sub>DDMEM</sub>	U13
ARDY	AC14	GND	J15	GND	R15	PG0	H2	SMS	AC13	V <sub>DDINT</sub>	H13	V <sub>DDMEM</sub>	U14
ARE	AB17	GND	K9	GND	T22	PG1	G1	SRAS	AB12	V <sub>DDINT</sub>	H14	V <sub>DDMEM</sub>	U15
AWE	AB14	GND	K10	GND	AC1	PG2	H1	SS/PG	AC20	V <sub>DDINT</sub>	H15	V <sub>DDMEM</sub>	U16
BMODE0	G2	GND	K11	GND	AC23	PG3	F1	SWE	AB10	V <sub>DDINT</sub>	H16	V <sub>DDOTP</sub>	AC12
BMODE1	F2	GND	K12	NC	A15	PG4	D1	TCK	L1	V <sub>DDINT</sub>	J8	V <sub>DDRTC</sub>	W23
BMODE2	E1	GND	K13	NC	A16	PG5	D2	TDI	J1	V <sub>DDINT</sub>	J16	V <sub>DDUSB</sub>	W22
BMODE3	E2	GND	K14	NC	A17	PG6	C2	TDO	K1	V <sub>DDINT</sub>	K8	V <sub>DDUSB</sub>	Y23
CLKBUF	AB19	GND	K15	NC	A18	PG7	B1	TMS	L2	V <sub>DDINT</sub>	K16	NC	G23
CLKIN	R23	GND	L9	NC	A19	PG8	C1	TRST	K2	V <sub>DDINT</sub>	L8	V <sub>R<sub>OUT</sub></sub> /EXT_WAKE1	AC18
CLKOUT	AB18	GND	L10	NC	A21	PG9	B2	USB_DM	AB21	V <sub>DDINT</sub>	L16	V <sub>R<sub>SEL</sub></sub> /V <sub>DDEXT</sub>	AB22
DATA0	Y1	GND	L11	NC	A22	PG10	B4	USB_DP	AA22	V <sub>DDINT</sub>	M8	XTAL	P23
DATA1	V2	GND	L12	NC	B20	PG11	B3	USB_ID	Y22	V <sub>DDINT</sub>	M16		
DATA2	W1	GND	L13	NC	B21	PG12	A2	USB_RSET	AC21	V <sub>DDINT</sub>	N8		
DATA3	U2	GND	L14	NC	B23	PG13	A3	USB_VBUS	AB20	V <sub>DDINT</sub>	N16		
DATA4	V1	GND	L15	NC	C23	PG14	A4	USB_VREF	AC22	V <sub>DDINT</sub>	P8		
DATA5	U1	GND	M9	NC	D22	PG15	A5	USB_XI	AB23	V <sub>DDINT</sub>	P16		

**NOTE:** In this table, **BOLD TYPE** indicates the sole signal/function for that ball on ADSP-BF522/ADSP-BF524/ADSP-BF526 processors.

<sup>1</sup> For ADSP-BF52xC compatibility, connect this ball to V<sub>DDEXT</sub>.

# ADSP-BF522/ADSP-BF523/ADSP-BF524/ADSP-BF525/ADSP-BF526/ADSP-BF527

**Table 68. 289-Ball CSP\_BGA Ball Assignment (Numerically by Ball Number)**

Ball No.	Signal	Ball No.	Signal	Ball No.	Signal	Ball No.	Signal	Ball No.	Signal	Ball No.	Signal		
A1	GND	B20	NC	H12	V <sub>DDINT</sub>	L9	GND	P2	DATA10	T22	GND	AB10	SWE
A2	PG12	B21	NC	H13	V <sub>DDINT</sub>	L10	GND	P7	V <sub>DDMEM</sub>	T23	PH9	AB11	VPPOTP
A3	PG13	B22	SCL	H14	V <sub>DDINT</sub>	L11	GND	P8	V <sub>DDINT</sub>	U1	DATA5	AB12	SRA <sub>S</sub>
A4	PG14	B23	NC	H15	V <sub>DDINT</sub>	L12	GND	P9	GND	U2	DATA3	AB13	SCKE
A5	PG15	C1	PG8	H16	V <sub>DDINT</sub>	L13	GND	P10	GND	U7	V <sub>DDMEM</sub>	AB14	AWE
A6	PPI_CLK/TMRCLK	C2	PG6	H17	GND <sup>1</sup>	L14	GND	P11	GND	U8	V <sub>DDMEM</sub>	AB15	AMS <sub>3</sub>
A7	PF0	C22	SDA	H22	GND	L15	GND	P12	GND	U9	V <sub>DDMEM</sub>	AB16	AMST
A8	PF2	C23	NC	H23	NC	L16	V <sub>DDINT</sub>	P13	GND	U10	V <sub>DDMEM</sub>	AB17	ARE
A9	PF14	D1	PG4	J1	TDI	L17	V <sub>DDEXT</sub>	P14	GND	U11	V <sub>DDMEM</sub>	AB18	CLKOUT
A10	PF15	D2	PG5	J2	EMU	L22	PH8	P15	GND	U12	V <sub>DDMEM</sub>	AB19	CLKBUF
A11	PH0	D22	NC	J7	V <sub>DDMEM</sub>	L23	PH7	P16	V <sub>DDINT</sub>	U13	V <sub>DDMEM</sub>	AB20	USB_VBUS
A12	PH1	D23	NC	J8	V <sub>DDINT</sub>	M1	DATA15	P17	V <sub>DDEXT</sub>	U14	V <sub>DDMEM</sub>	AB21	USB_DM
A13	PH2	E1	BMODE2	J9	GND	M2	DATA14	P22	PH15	U15	V <sub>DDMEM</sub>	AB22	VR <sub>SEL</sub> /V <sub>DDEXT</sub>
A14	PH4	E2	BMODE3	J10	GND	M7	V <sub>DDMEM</sub>	P23	XTAL	U16	V <sub>DDMEM</sub>	AB23	USB_XI
A15	NC	E22	NC	J11	GND	M8	V <sub>DDINT</sub>	R1	DATA8	U17	V <sub>DDEXT</sub>	AC1	GND
A16	NC	E23	NC	J12	GND	M9	GND	R2	DATA11	U22	NMI	AC2	ADDR14
A17	NC	F1	PG3	J13	GND	M10	GND	R7	V <sub>DDMEM</sub>	U23	RTXI	AC3	ADDR12
A18	NC	F2	BMODE1	J14	GND	M11	GND	R8	V <sub>DDINT</sub>	V1	DATA4	AC4	ADDR10
A19	NC	F22	NC	J15	GND	M12	GND	R9	GND	V2	DATA1	AC5	ADDR9
A20	PF9	F23	NC	J16	V <sub>DDINT</sub>	M13	GND	R10	GND	V22	RESET	AC6	ADDR5
A21	NC	G1	PG1	J17	V <sub>DDEXT</sub>	M14	GND	R11	GND	V23	RTXO	AC7	ADDR4
A22	NC	G2	BMODE0	J22	GND <sup>1</sup>	M15	GND	R12	GND	W1	DATA2	AC8	ADDR2
A23	GND	G7	V <sub>DDEXT</sub>	J23	NC	M16	V <sub>DDINT</sub>	R13	GND	W2	ADDR16	AC9	ABE1/SDQM1
B1	PG7	G8	V <sub>DDEXT</sub>	K1	TDO	M17	V <sub>DDEXT</sub>	R14	GND	W22	V <sub>DDUSB</sub>	AC10	SA10
B2	PG9	G9	V <sub>DDEXT</sub>	K2	TRST	M22	PH10	R15	GND	W23	V <sub>DDRTC</sub>	AC11	SRA <sub>S</sub>
B3	PG11	G10	V <sub>DDEXT</sub>	K7	V <sub>DDMEM</sub>	M23	PH12	R16	V <sub>DDINT</sub>	Y1	DATA0	AC12	V <sub>DDOTP</sub>
B4	PG10	G11	V <sub>DDEXT</sub>	K8	V <sub>DDINT</sub>	N1	DATA12	R17	V <sub>DDEXT</sub>	Y2	ADDR17	AC13	SMS
B5	V <sub>DDINT</sub>	G12	V <sub>DDEXT</sub>	K9	GND	N2	DATA13	R22	PH11	Y22	USB_ID	AC14	ARDY
B6	GND	G13	V <sub>DDEXT</sub>	K10	GND	N7	V <sub>DDMEM</sub>	R23	CLKIN	Y23	V <sub>DDUSB</sub>	AC15	AOE
B7	PPI_FS1/TMRO	G14	V <sub>DDEXT</sub>	K11	GND	N8	V <sub>DDINT</sub>	T1	DATA7	AA1	ADDR18	AC16	AMS2
B8	PF1	G15	V <sub>DDEXT</sub>	K12	GND	N9	GND	T2	DATA6	AA2	ADDR15	AC17	AMS0
B9	PF3	G16	GND <sup>1</sup>	K13	GND	N10	GND	T7	V <sub>DDMEM</sub>	AA22	USB_DP	AC18	VR <sub>OUT</sub> /EXT_WAKE1
B10	PF5	G17	GND	K14	GND	N11	GND	T8	V <sub>DDINT</sub>	AA23	USB_XO	AC19	EXT_WAKE0
B11	PF4	G22	NC	K15	GND	N12	GND	T9	V <sub>DDINT</sub>	AB1	ADDR19	AC20	SS/PG
B12	PF6	G23	NC	K16	V <sub>DDINT</sub>	N13	GND	T10	V <sub>DDINT</sub>	AB2	ADDR13	AC21	USB_RSET
B13	PF7	H1	PG2	K17	V <sub>DDEXT</sub>	N14	GND	T11	V <sub>DDINT</sub>	AB3	ADDR11	AC22	USB_VREF
B14	PH3	H2	PG0	K22	PH6	N15	GND	T12	V <sub>DDINT</sub>	AB4	ADDR7	AC23	GND
B15	PF10	H7	V <sub>DDEXT</sub>	K23	PH5	N16	V <sub>DDINT</sub>	T13	V <sub>DDINT</sub>	AB5	ADDR8		
B16	PF8	H8	V <sub>DDINT</sub>	L1	TCK	N17	V <sub>DDEXT</sub>	T14	V <sub>DDINT</sub>	AB6	ADDR6		
B17	PF11	H9	V <sub>DDINT</sub>	L2	TMS	N22	PH13	T15	V <sub>DDINT</sub>	AB7	ADDR3		
B18	PF12	H10	V <sub>DDINT</sub>	L7	V <sub>DDMEM</sub>	N23	PH14	T16	V <sub>DDINT</sub>	AB8	ADDR1		
B19	PF13	H11	V <sub>DDINT</sub>	L8	V <sub>DDINT</sub>	P1	DATA9	T17	V <sub>DDEXT</sub>	AB9	ABE0/SDQM0		

**NOTE:** In this table, **BOLD TYPE** indicates the sole signal/function for that ball on ADSP-BF522/ADSP-BF524/ADSP-BF526 processors.

<sup>1</sup> For ADSP-BF52xC compatibility, connect this ball to V<sub>DDEXT</sub>.



# ADSP-BF522/ADSP-BF523/ADSP-BF524/ADSP-BF525/ADSP-BF526/ADSP-BF527

Figure 76 shows the top view of the BC-289-2 CSP\_BGA ball configuration. Figure 77 shows the bottom view of the BC-289-2 CSP\_BGA ball configuration.



Figure 76. 289-Ball CSP\_BGA Ball Configuration (Top View)

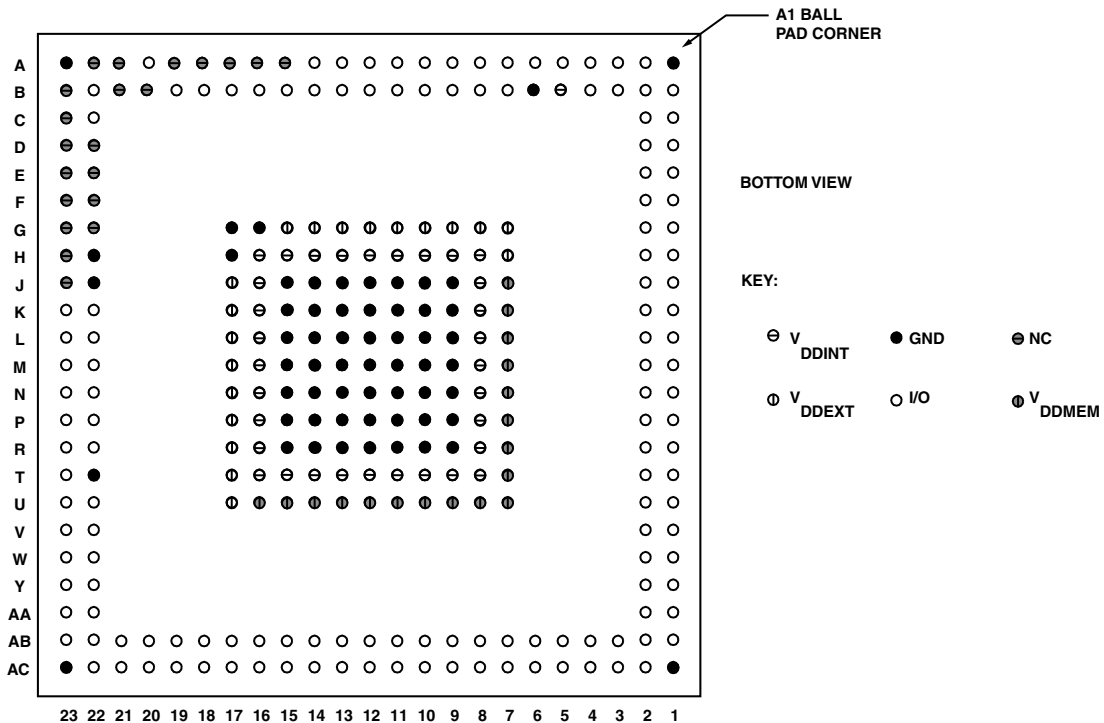

Figure 77. 289-Ball CSP\_BGA Ball Configuration (Bottom View)

# ADSP-BF522/ADSP-BF523/ADSP-BF524/ADSP-BF525/ADSP-BF526/ADSP-BF527

## 208-BALL CSP\_BGA BALL ASSIGNMENT

Table 69 lists the CSP\_BGA balls by signal mnemonic.

Table 70 on Page 83 lists the CSP\_BGA by ball number.

**Table 69. 208-Ball CSP\_BGA Ball Assignment (Alphabetically by Signal)**

Signal	Ball No.	Signal	Ball No.	Signal	Ball No.	Signal	Ball No.	Signal	Ball No.	Signal	Ball No.
$\overline{ABE0}/SDQM0$	V19	CLKOUT	K20	GND	K11	PF13	A5	PPI_CLK/TMRCLK	G2	V <sub>DDEXT</sub>	J8
$\overline{ABE1}/SDQM1$	V20	DATA0	Y8	GND	K12	PF14	B6	PPI_FS1/TMRO	F2	V <sub>DDEXT</sub>	K7
ADDR1	W20	DATA1	W8	GND	K13	PF15	A6	$\overline{RESET}$	B18	V <sub>DDEXT</sub>	K8
ADDR2	W19	DATA2	Y7	GND	L9	PG0	R2	RTXI	A14	V <sub>DDEXT</sub>	L7
ADDR3	Y19	DATA3	W7	GND	L10	PG1	P1	RTXO	A15	V <sub>DDINT</sub>	G12
ADDR4	W18	DATA4	Y6	GND	L11	PG2	P2	SA10	U19	V <sub>DDINT</sub>	G13
ADDR5	Y18	DATA5	W6	GND	L12	PG3	N1	$\overline{SCAS}$	U20	V <sub>DDINT</sub>	G14
ADDR6	W17	DATA6	Y5	GND	L13	PG4	N2	SCKE	P20	V <sub>DDINT</sub>	H14
ADDR7	Y17	DATA7	W5	GND	M9	PG5	M1	SCL	A4	V <sub>DDINT</sub>	J14
ADDR8	W16	DATA8	Y4	GND	M10	PG6	M2	SDA	B4	V <sub>DDINT</sub>	K14
ADDR9	Y16	DATA9	W4	GND	M11	PG7	L1	$\overline{SMS}$	R19	V <sub>DDINT</sub>	L14
ADDR10	W15	DATA10	Y3	GND	M12	PG8	L2	$\overline{SRAS}$	T19	V <sub>DDINT</sub>	M14
ADDR11	Y15	DATA11	W3	GND	M13	PG9	K1	SS/ $\overline{PG}$	G19	V <sub>DDINT</sub>	N14
ADDR12	W14	DATA12	Y2	GND	N9	PG10	K2	$\overline{SWE}$	T20	V <sub>DDINT</sub>	P12
ADDR13	Y14	DATA13	W2	GND	N10	PG11	J1	TCK	V2	V <sub>DDINT</sub>	P13
ADDR14	W13	DATA14	W1	GND	N11	PG12	J2	TDI	R1	V <sub>DDINT</sub>	P14
ADDR15	Y13	DATA15	V1	GND	N12	PG13	H1	TDO	T1	V <sub>DDMEM</sub>	L8
ADDR16	W12	EMU	T2	GND	N13	PG14	H2	TMS	U2	V <sub>DDMEM</sub>	M7
ADDR17	Y12	EXT_WAKE0	J20	GND	Y1	PG15	G1	$\overline{TRST}$	U1	V <sub>DDMEM</sub>	M8
ADDR18	W11	GND	A1	GND	Y20	PH0	A7	USB_DM	F20	V <sub>DDMEM</sub>	N7
ADDR19	Y11	GND	A17	$\overline{NMI}$	B19	PH1	B7	USB_DP	E20	V <sub>DDMEM</sub>	N8
$\overline{AMS0}$	J19	GND	A20	VPPOTP	L19	PH2	A8	USB_ID	C20	V <sub>DDMEM</sub>	P7
$\overline{AMS1}$	K19	GND	B20	PF0	F1	PH3	B8	USB_RSET	D20	V <sub>DDMEM</sub>	P8
$\overline{AMS2}$	M19	GND	H9	PF1	E1	PH4	A9	USB_VBUS	E19	V <sub>DDMEM</sub>	P9
$\overline{AMS3}$	L20	GND	H10	PF2	E2	PH5	B9	USB_VREF	H19	V <sub>DDMEM</sub>	P10
$\overline{AOE}$	N20	GND	H11	PF3	D1	PH6	B10	USB_XI	A19	V <sub>DDMEM</sub>	P11
ARDY	P19	GND	H12	PF4	D2	PH7	B11	USB_XO	A18	V <sub>DDOTP</sub>	R20
$\overline{ARE}$	M20	GND	H13	PF5	C1	PH8	A12	V <sub>DDEXT</sub>	G7	V <sub>DDRTC</sub>	A16
AWE	N19	GND	J9	PF6	C2	PH9	B12	V <sub>DDEXT</sub>	G8	V <sub>DDUSB</sub>	D19
BMODE0	Y10	GND	J10	PF7	B1	PH10	A13	V <sub>DDEXT</sub>	G9	V <sub>DDUSB</sub>	G20
BMODE1	W10	GND	J11	PF8	B2	PH11	B13	V <sub>DDEXT</sub>	G10	V <sub>R<sub>OUT</sub></sub> / <b>EXT_WAKE1</b>	H20
BMODE2	Y9	GND	J12	PF9	A2	PH12	B14	V <sub>DDEXT</sub>	G11	V <sub>R<sub>SEL</sub></sub> / <b>V<sub>DDEXT</sub></b>	F19
BMODE3	W9	GND	J13	PF10	B3	PH13	B15	V <sub>DDEXT</sub>	H7	XTAL	A10
CLKBUF	C19	GND	K9	PF11	A3	PH14	B16	V <sub>DDEXT</sub>	H8		
CLKIN	A11	GND	K10	PF12	B5	PH15	B17	V <sub>DDEXT</sub>	J7		

**NOTE:** In this table, **BOLD TYPE** indicates the sole signal/function for that ball on ADSP-BF522/ADSP-BF524/ADSP-BF526 processors.

# ADSP-BF522/ADSP-BF523/ADSP-BF524/ADSP-BF525/ADSP-BF526/ADSP-BF527

**Table 70. 208-Ball CSP\_BGA Ball Assignment (Numerically by Ball Number)**

Ball No.	Signal	Ball No.	Signal	Ball No.	Signal	Ball No.	Signal	Ball No.	Signal
A1	GND	B16	PH14	H7	V <sub>DDEXT</sub>	L2	PG8	P1	PG1
A2	PF9	B17	PH15	H8	V <sub>DDEXT</sub>	L7	V <sub>DDEXT</sub>	P2	PG2
A3	PF11	B18	$\overline{\text{RESET}}$	H9	GND	L8	V <sub>DDMEM</sub>	P7	V <sub>DDMEM</sub>
A4	SCL	B19	$\overline{\text{NMI}}$	H10	GND	L9	GND	P8	V <sub>DDMEM</sub>
A5	PF13	B20	GND	H11	GND	L10	GND	P9	V <sub>DDMEM</sub>
A6	PF15	C1	PF5	H12	GND	L11	GND	P10	V <sub>DDMEM</sub>
A7	PH0	C2	PF6	H13	GND	L12	GND	P11	V <sub>DDMEM</sub>
A8	PH2	C19	CLKBUF	H14	V <sub>DDINT</sub>	L13	GND	P12	V <sub>DDINT</sub>
A9	PH4	C20	USB_ID	H19	USB_VREF	L14	V <sub>DDINT</sub>	P13	V <sub>DDINT</sub>
A10	XTAL	D1	PF3	H20	VR <sub>OUT</sub> / <b>EXT_WAKE1</b>	L19	VPPOTP	P14	V <sub>DDINT</sub>
A11	CLKIN	D2	PF4	J1	PG11	L20	$\overline{\text{AMS3}}$	P19	ARDY
A12	PH8	D19	V <sub>DDUSB</sub>	J2	PG12	M1	PG5	P20	SCKE
A13	PH10	D20	USB_RSET	J7	V <sub>DDEXT</sub>	M2	PG6	R1	TDI
A14	RTXI	E1	PF1	J8	V <sub>DDEXT</sub>	M7	V <sub>DDMEM</sub>	R2	PG0
A15	RTXO	E2	PF2	J9	GND	M8	V <sub>DDMEM</sub>	R19	$\overline{\text{SMS}}$
A16	V <sub>DDRTC</sub>	E19	USB_VBUS	J10	GND	M9	GND	R20	V <sub>DDOTP</sub>
A17	GND	E20	USB_DP	J11	GND	M10	GND	T1	TDO
A18	USB_XO	F1	PF0	J12	GND	M11	GND	T2	EMU
A19	USB_XI	F2	PPI_FS1/TMRO	J13	GND	M12	GND	T19	$\overline{\text{SRAS}}$
A20	GND	F19	VR <sub>SEL</sub> / <b>V<sub>DDEXT</sub></b>	J14	V <sub>DDINT</sub>	M13	GND	T20	$\overline{\text{SWE}}$
B1	PF7	F20	USB_DM	J19	$\overline{\text{AMS0}}$	M14	V <sub>DDINT</sub>	U1	$\overline{\text{TRST}}$
B2	PF8	G1	PG15	J20	EXT_WAKE0	M19	$\overline{\text{AMS2}}$	U2	TMS
B3	PF10	G2	PPI_CLK/TMRCLK	K1	PG9	M20	$\overline{\text{ARE}}$	U19	SA10
B4	SDA	G7	V <sub>DDEXT</sub>	K2	PG10	N1	PG3	U20	$\overline{\text{SCAS}}$
B5	PF12	G8	V <sub>DDEXT</sub>	K7	V <sub>DDEXT</sub>	N2	PG4	V1	DATA15
B6	PF14	G9	V <sub>DDEXT</sub>	K8	V <sub>DDEXT</sub>	N7	V <sub>DDMEM</sub>	V2	TCK
B7	PH1	G10	V <sub>DDEXT</sub>	K9	GND	N8	V <sub>DDMEM</sub>	V19	$\overline{\text{ABE0}}/\text{SDQM0}$
B8	PH3	G11	V <sub>DDEXT</sub>	K10	GND	N9	GND	V20	$\overline{\text{ABE1}}/\text{SDQM1}$
B9	PH5	G12	V <sub>DDINT</sub>	K11	GND	N10	GND	W1	DATA14
B10	PH6	G13	V <sub>DDINT</sub>	K12	GND	N11	GND	W2	DATA13
B11	PH7	G14	V <sub>DDINT</sub>	K13	GND	N12	GND	W3	DATA11
B12	PH9	G19	SS/ <b>PG</b>	K14	V <sub>DDINT</sub>	N13	GND	W4	DATA9
B13	PH11	G20	V <sub>DDUSB</sub>	K19	$\overline{\text{AMST}}$	N14	V <sub>DDINT</sub>	W5	DATA7
B14	PH12	H1	PG13	K20	CLKOUT	N19	$\overline{\text{AWE}}$	W6	DATA5
B15	PH13	H2	PG14	L1	PG7	N20	$\overline{\text{AOE}}$	W7	DATA3
								W8	DATA1
								W9	BMODE3
								W10	BMODE1
								W11	ADDR18
								W12	ADDR16
								W13	ADDR14
								W14	ADDR12
								W15	ADDR10
								W16	ADDR8
								W17	ADDR6
								W18	ADDR4
								W19	ADDR2
								W20	ADDR1
								Y1	GND
								Y2	DATA12
								Y3	DATA10
								Y4	DATA8
								Y5	DATA6
								Y6	DATA4
								Y7	DATA2
								Y8	DATA0
								Y9	BMODE2
								Y10	BMODE0
								Y11	ADDR19
								Y12	ADDR17
								Y13	ADDR15
								Y14	ADDR13
								Y15	ADDR11
								Y16	ADDR9
								Y17	ADDR7
								Y18	ADDR5
								Y19	ADDR3
								Y20	GND

**NOTE:** In this table, **BOLD TYPE** indicates the sole signal/function for that ball on ADSP-BF522/ADSP-BF524/ADSP-BF526 processors.

# ADSP-BF522/ADSP-BF523/ADSP-BF524/ADSP-BF525/ADSP-BF526/ADSP-BF527

Figure 78 shows the top view of the CSP\_BGA ball configuration. Figure 79 shows the bottom view of the CSP\_BGA ball configuration.

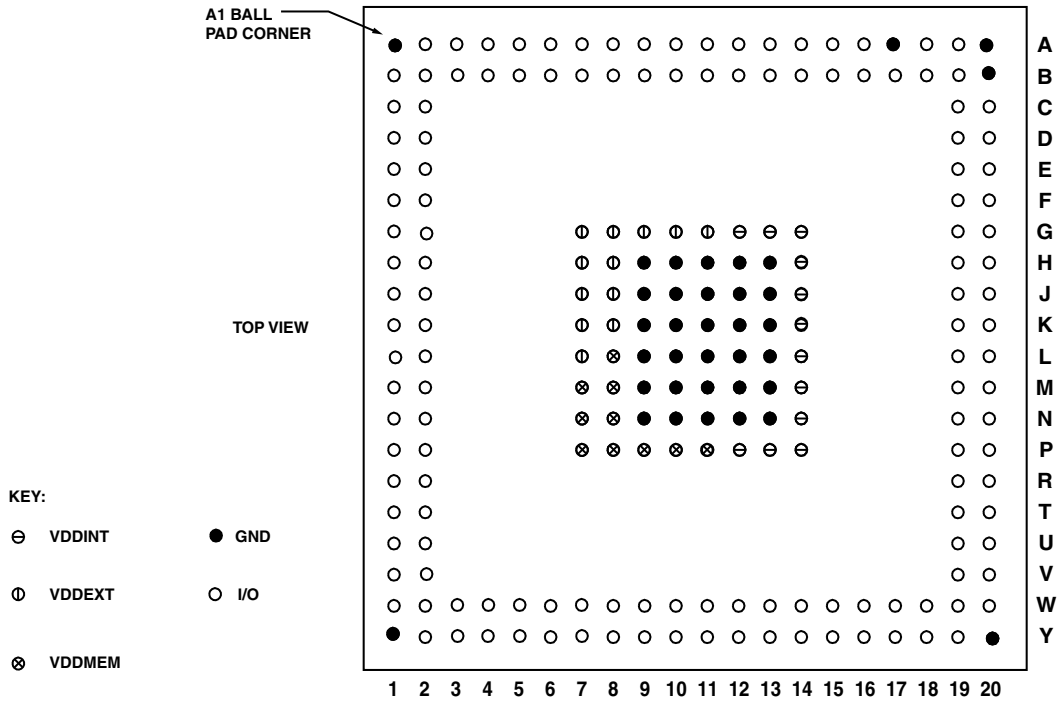

Figure 78. 208-Ball CSP\_BGA Ball Configuration (Top View)



Figure 79. 208-Ball CSP\_BGA Ball Configuration (Bottom View)

# ADSP-BF522/ADSP-BF523/ADSP-BF524/ADSP-BF525/ADSP-BF526/ADSP-BF527

## OUTLINE DIMENSIONS

Dimensions in the outline dimension figures (Figure 80 and Figure 81) are shown in millimeters.



\*COMPLIANT WITH JEDEC STANDARD MO-275-GGCE-1

Figure 80. 289-Ball CSP\_BGA (BC-289-2)

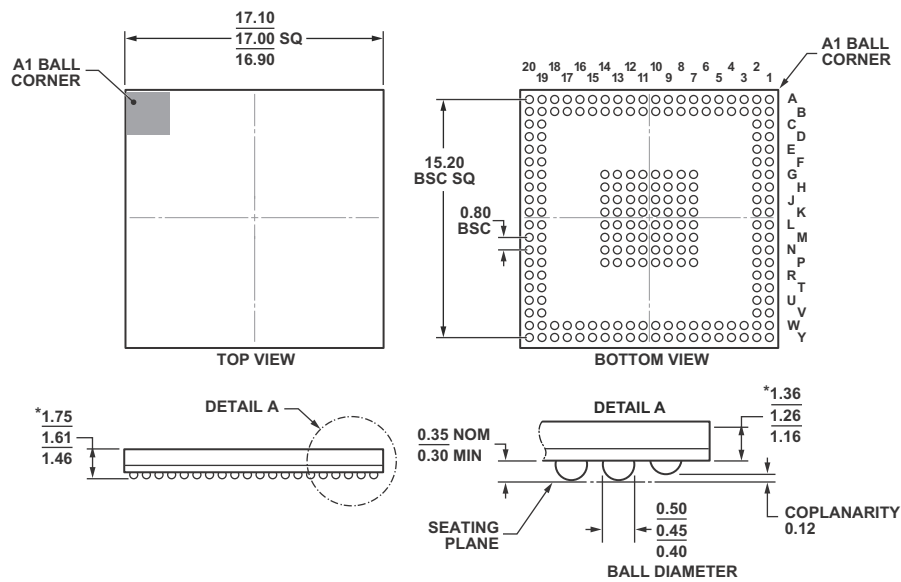

\*COMPLIANT TO JEDEC STANDARDS MO-275-MMAB-1 WITH EXCEPTION TO PACKAGE HEIGHT AND THICKNESS.

Figure 81. 208-Ball CSP\_BGA (BC-208-2)

# ADSP-BF522/ADSP-BF523/ADSP-BF524/ADSP-BF525/ADSP-BF526/ADSP-BF527

## SURFACE-MOUNT DESIGN

Table 71 is provided as an aid to PCB design. For industry-standard design recommendations, refer to *IPC-7351, Generic Requirements for Surface Mount Design and Land Pattern Standard*.

Table 71. Surface-Mount Design Supplement

Package	Package Ball Attach Type	Package Solder Mask Opening	Package Ball Pad Size
289-Ball CSP_BGA	Solder Mask Defined	0.26 mm diameter	0.35 mm diameter
208-Ball CSP_BGA	Solder Mask Defined	0.40 mm diameter	0.50 mm diameter

## AUTOMOTIVE PRODUCTS

The ADBF525W model is available with controlled manufacturing to support the quality and reliability requirements of automotive applications. Note that these automotive models may have specifications that differ from the commercial models and designers should review the product Specifications section

of this data sheet carefully. Only the automotive grade products shown in Table 72 are available for use in automotive applications. Contact your local ADI account representative for specific product ordering information and to obtain the specific automotive Reliability reports for these models.

Table 72. Automotive Products

Automotive Models <sup>1,2</sup>	Temperature Range <sup>3</sup>	Package Description	Package Option	Instruction Rate (Max)
ADBF525WBBCZ4xx	-40°C to +85°C	208-Ball CSP_BGA	BC-208-2	400 MHz
ADBF525WBBCZ5xx	-40°C to +85°C	208-Ball CSP_BGA	BC-208-2	533 MHz
ADBF525WYBCZxxx	-40°C to +105°C	208-Ball CSP_BGA	BC-208-2	For product details, please contact your ADI account representative.

<sup>1</sup> Z = RoHS Compliant Part.

<sup>2</sup> The information indicated by x in the model number will be provided by your ADI account representative.

<sup>3</sup> Referenced temperature is ambient temperature. The ambient temperature is not a specification. Please see [Operating Conditions for ADSP-BF523/ADSP-BF525/ADSP-BF527 Processors on Page 29](#) for junction temperature (T<sub>j</sub>) specification which is the only temperature specification.

# ADSP-BF522/ADSP-BF523/ADSP-BF524/ADSP-BF525/ADSP-BF526/ADSP-BF527

## ORDERING GUIDE

Model <sup>1</sup>	Temperature Range <sup>2</sup>	Instruction Rate (Max)	Package Description	Package Option
ADSP-BF522BBCZ-3A	−40°C to +85°C	300 MHz	208-Ball Chip Scale Package Ball Grid Array (CSP_BGA)	BC-208-2
ADSP-BF522BBCZ-4A	−40°C to +85°C	400 MHz	208-Ball Chip Scale Package Ball Grid Array (CSP_BGA)	BC-208-2
ADSP-BF522KBCZ-3	0°C to +70°C	300 MHz	289-Ball Chip Scale Package Ball Grid Array (CSP_BGA)	BC-289-2
ADSP-BF522KBCZ-4	0°C to +70°C	400 MHz	289-Ball Chip Scale Package Ball Grid Array (CSP_BGA)	BC-289-2
ADSP-BF523BBCZ-5A	−40°C to +85°C	533 MHz	208-Ball Chip Scale Package Ball Grid Array (CSP_BGA)	BC-208-2
ADSP-BF523KBCZ-5	0°C to +70°C	533 MHz	289-Ball Chip Scale Package Ball Grid Array (CSP_BGA)	BC-289-2
ADSP-BF523KBCZ-6	0°C to +70°C	600 MHz	289-Ball Chip Scale Package Ball Grid Array (CSP_BGA)	BC-289-2
ADSP-BF523KBCZ-6A	0°C to +70°C	600 MHz	208-Ball Chip Scale Package Ball Grid Array (CSP_BGA)	BC-208-2
ADSP-BF524BBCZ-3A	−40°C to +85°C	300 MHz	208-Ball Chip Scale Package Ball Grid Array (CSP_BGA)	BC-208-2
ADSP-BF524BBCZ-4A	−40°C to +85°C	400 MHz	208-Ball Chip Scale Package Ball Grid Array (CSP_BGA)	BC-208-2
ADSP-BF524KBCZ-3	0°C to +70°C	300 MHz	289-Ball Chip Scale Package Ball Grid Array (CSP_BGA)	BC-289-2
ADSP-BF524KBCZ-4	0°C to +70°C	400 MHz	289-Ball Chip Scale Package Ball Grid Array (CSP_BGA)	BC-289-2
ADSP-BF525ABCZ-5	−40°C to +70°C	500 MHz	289-Ball Chip Scale Package Ball Grid Array (CSP_BGA)	BC-289-2
ADSP-BF525ABCZ-6	−40°C to +70°C	600 MHz	289-Ball Chip Scale Package Ball Grid Array (CSP_BGA)	BC-289-2
ADSP-BF525BBCZ-5A	−40°C to +85°C	533 MHz	208-Ball Chip Scale Package Ball Grid Array (CSP_BGA)	BC-208-2
ADSP-BF525KBCZ-5	0°C to +70°C	533 MHz	289-Ball Chip Scale Package Ball Grid Array (CSP_BGA)	BC-289-2
ADSP-BF525KBCZ-6	0°C to +70°C	600 MHz	289-Ball Chip Scale Package Ball Grid Array (CSP_BGA)	BC-289-2
ADSP-BF525KBCZ-6A	0°C to +70°C	600 MHz	208-Ball Chip Scale Package Ball Grid Array (CSP_BGA)	BC-208-2
ADSP-BF526BBCZ-3A	−40°C to +85°C	300 MHz	208-Ball Chip Scale Package Ball Grid Array (CSP_BGA)	BC-208-2
ADSP-BF526BBCZ-4A	−40°C to +85°C	400 MHz	208-Ball Chip Scale Package Ball Grid Array (CSP_BGA)	BC-208-2
ADSP-BF526KBCZ-3	0°C to +70°C	300 MHz	289-Ball Chip Scale Package Ball Grid Array (CSP_BGA)	BC-289-2
ADSP-BF526KBCZ-4	0°C to +70°C	400 MHz	289-Ball Chip Scale Package Ball Grid Array (CSP_BGA)	BC-289-2
ADSP-BF527BBCZ-5A	−40°C to +85°C	533 MHz	208-Ball Chip Scale Package Ball Grid Array (CSP_BGA)	BC-208-2
ADSP-BF527KBCZ-5	0°C to +70°C	533 MHz	289-Ball Chip Scale Package Ball Grid Array (CSP_BGA)	BC-289-2
ADSP-BF527KBCZ-6	0°C to +70°C	600 MHz	289-Ball Chip Scale Package Ball Grid Array (CSP_BGA)	BC-289-2
ADSP-BF527KBCZ-6A	0°C to +70°C	600 MHz	208-Ball Chip Scale Package Ball Grid Array (CSP_BGA)	BC-208-2

<sup>1</sup> Z = RoHS Compliant Part.

<sup>2</sup> Referenced temperature is ambient temperature. The ambient temperature is not a specification. Please see [Operating Conditions for ADSP-BF522/ADSP-BF524/ADSP-BF526 Processors on Page 27](#) and [Operating Conditions for ADSP-BF523/ADSP-BF525/ADSP-BF527 Processors on Page 29](#) for junction temperature (T<sub>j</sub>) specification which is the only temperature specification.

**ADSP-BF522/ADSP-BF523/ADSP-BF524/ADSP-BF525/ADSP-BF526/ADSP-BF527**



## Данный компонент на территории Российской Федерации

### Вы можете приобрести в компании MosChip.

Для оперативного оформления запроса Вам необходимо перейти по данной ссылке:

<http://moschip.ru/get-element>

Вы можете разместить у нас заказ для любого Вашего проекта, будь то серийное производство или разработка единичного прибора.

В нашем ассортименте представлены ведущие мировые производители активных и пассивных электронных компонентов.

Нашей специализацией является поставка электронной компонентной базы двойного назначения, продукции таких производителей как XILINX, Intel (ex.ALTERA), Vicor, Microchip, Texas Instruments, Analog Devices, Mini-Circuits, Amphenol, Glenair.

Сотрудничество с глобальными дистрибьюторами электронных компонентов, предоставляет возможность заказывать и получать с международных складов практически любой перечень компонентов в оптимальные для Вас сроки.

На всех этапах разработки и производства наши партнеры могут получить квалифицированную поддержку опытных инженеров.

Система менеджмента качества компании отвечает требованиям в соответствии с ГОСТ Р ИСО 9001, ГОСТ РВ 0015-002 и ЭС РД 009

### Офис по работе с юридическими лицами:

105318, г.Москва, ул.Щербаковская д.3, офис 1107, 1118, ДЦ «Щербаковский»

Телефон: +7 495 668-12-70 (многоканальный)

Факс: +7 495 668-12-70 (доб.304)

E-mail: [info@moschip.ru](mailto:info@moschip.ru)

Skype отдела продаж:

moschip.ru

moschip.ru\_4

moschip.ru\_6

moschip.ru\_9