

---

### 0.8% Accuracy, Voltage Detector with Delay Function

---

NO.EA-306-160309

#### OUTLINE

The RP300x is a CMOS-based voltage detector (VD) IC with a built-in output delay circuit. Internally, a single IC consists of a voltage reference unit, a comparator, a resistor net for setting detector threshold, a manual reset circuit, an output delay circuit and an output driver transistor.

The RP300x is available in internally fixed detector threshold type. When the  $V_{DD}$  voltage becomes lower than the preset voltage, the RP300xxxxA/C generates a "L" reset signal and the RP300xxxxB (custom IC<sup>\*1</sup>) generates a "H" reset signal. The detector threshold accuracy is as high as  $\pm 1.0\%$  when  $-V_{SET}^{*2} < 1.7\text{ V}$  and  $\pm 0.8\%$  when  $1.7\text{ V} \leq -V_{SET}$ .

The reset output signal remains asserted for 50 ms, 100 ms (custom IC) or 200 ms after the  $V_{DD}$  voltage rises above the threshold voltage or when manual reset is canceled. The RP300x is designed to ignore fast transients on the  $V_{DD}$  pin. The output delay time accuracy is as high as  $\pm 5.0\%$ .

The RP300x is available in an Nch open drain output type or in a CMOS output type.

The RP300x is offered in an ultra-small DFN(PLP)1010-4B package or in a SOT-23-5 package.

<sup>\*1</sup> For more information about a custom IC, please contact our sales representatives.

<sup>\*2</sup>  $-V_{SET}$  is defined as a preset detector threshold.

#### FEATURES

- Supply Current ..... Typ. 0.95  $\mu\text{A}$  ( $-V_{SET} = 3.08\text{ V}$ ,  $V_{DD} = 3.18\text{ V}$ )
- Operating Voltage Range ..... 0.72 V to 5.50 V (25°C)
- Detector Threshold Range ..... 1.1 V, 2.32 V, 2.63 V, 2.7 V, 2.8 V, 2.93 V, 3.08 V, 3.4 V (34), 4.38 V (43), 4.6 V (46)
- Detector Threshold Accuracy .....  $\pm 1.0\%$  ( $-V_{SET} < 1.7\text{ V}$ ),  $\pm 0.8\%$  ( $1.7\text{ V} \leq -V_{SET}$ )
- Detector Threshold Temperature Coefficient ..... Typ.  $\pm 50\text{ ppm}/^\circ\text{C}$
- Released Output Delay Time ..... Typ. 50 ms, 100 ms (custom IC), 200 ms
- Released Output Delay Time Accuracy .....  $\pm 5\%$  (25°C),  $\pm 15\%$  ( $-40^\circ\text{C}$  to  $85^\circ\text{C}$ )
- Package ..... DFN(PLP)1010-4B, SOT-23-5
- Output Type ..... Nch Open Drain output, CMOS Output
- Reset Signal ..... Active-low, Active-high (custom IC)

#### APPLICATIONS

- Voltage monitoring for handheld communication equipment, camera and VCRs.
- Voltage monitoring for battery-powered equipment

**BLOCK DIAGRAMS**



Figure 1. RP300xxxxA/B (Nch Open Drain Output)



Figure 2. RP300xxxxC (CMOS Output)

**SELECTION GUIDE**

With the RP300x, the detector threshold, the package type, the released output delay time and the output type are user-selectable options.

| Product Name       | Package         | Quantity per Reel | Pb Free | Halogen Free |
|--------------------|-----------------|-------------------|---------|--------------|
| RP300Kxy*(z)-TR    | DFN(PLP)1010-4B | 10,000 pcs        | Yes     | Yes          |
| RP300Nxy*(z)-TR-FE | SOT-23-5        | 3,000 pcs         | Yes     | Yes          |

xx: Specify  $-V_{SET}$  from 1.1 V (11), 2.32 V (23), 2.63 V (26), 2.7 V (27), 2.8 V (28), 2.93 V (29), 3.08 V (30), 3.4 V (34), 4.38 V (43), 4.6 V (46).

z: If  $-V_{SET}$  includes the 3<sup>rd</sup> digit, indicate the digit of 0.01 V.  
Ex. If  $-V_{SET}$  is 2.63 V, indicate as RP300x26xx3-TR-x.

y: Specify the released output delay time.  
(A) 50 ms  
(B) 100 ms (custom IC)  
(D) 200 ms

\*: Specify the output type.  
(A) Nch Open Drain Output  
(B) Nch Open Drain Inverting Output (custom IC)  
(C) CMOS Output

## PIN CONFIGURATIONS

• DFN(PLP)1010-4B



Figure 3. Top View



Figure 4. Bottom View

• SOT- 23-5



Figure 5. Mark Side

## PIN DESCRIPTION

RP300K: DFN(PLP)1010-4B

| Pin No. | Symbol          | Pin Description   |
|---------|-----------------|---|
| 1       | OUT             | Output Pin<br>RP300xxxxA/C: asserts an active-low reset signal when a voltage drops below the detector threshold.<br>RP300xxxxB: asserts an active-high reset signal when a voltage drops below the detector threshold. (custom IC) |
| 2       | MR              | Manual Reset Input Pin: active-low  |
| 3       | GND             | Ground Pin  |
| 4       | V <sub>DD</sub> | Input Pin   |

The tab on the bottom of the package enhances thermal performance and is electrically connected to GND (substrate level). It is recommended that the tab be connected to the ground plane on the board. If not, the tab can be left open.

RP300N: SOT-23-5

| Pin No. | Symbol          | Description   |
|---------|-----------------|---|
| 1       | MR              | Manual Reset Input Pin: active-low  |
| 2       | GND             | Ground Pin  |
| 3       | NC              | No Connection   |
| 4       | OUT             | Output Pin<br>RP300xxxxA/C: asserts an active-low reset signal when a voltage drops below the detector threshold.<br>RP300xxxxB: asserts an active-high reset signal when a voltage drops below the detector threshold. (custom IC) |
| 5       | V <sub>DD</sub> | Input Pin   |

**ABSOLUTE MAXIMUM RATINGS**

| Symbol           | Item  | Rating                       | Unit |    |
|------------------|---|------------------------------|------|----|
| V <sub>IN</sub>  | Input Voltage   | 6.0                          | V    |    |
| OUT              | Output Voltage (Nch Open Drain Output)                  | -0.3 to 6.0                  | V    |    |
|                  | Output Voltage (CMOS Output)                            | -0.3 to V <sub>DD</sub> +0.3 |      |    |
| MR               | Manual Reset Pin  | -0.3 to V <sub>DD</sub> +0.3 | V    |    |
| I <sub>OUT</sub> | Output Current  | 20                           | mA   |    |
| P <sub>D</sub>   | Power Dissipation (Standard Land Pattern) <sup>*3</sup> | DFN(PLP)1010-4B              | 400  | mW |
|                  |   | SOT-23-5                     | 420  |    |
| T <sub>a</sub>   | Operating Temperature Range                             | -40 to +85                   | °C   |    |
| T <sub>stg</sub> | Storage Temperature Range                               | -55 to +125                  | °C   |    |

<sup>\*3</sup> Refer to the next page for detailed information about Power Dissipation.

**ABSOLUTE MAXIMUM RATINGS**

Electronic and mechanical stress momentarily exceeded absolute maximum ratings may cause the permanent damages and may degrade the life time and safety for both device and system using the device in the field. The functional operation at or over these absolute maximum ratings is not assured.

**RECOMMENDED OPERATING CONDITIONS (ELECTRICAL CHARACTERISTICS)**

All of electronic equipment should be designed that the mounted semiconductor devices operate within the recommended operating conditions. The semiconductor devices cannot operate normally over the recommended operating conditions, even if when they are used over such conditions by momentary electronic noise or surge. And the semiconductor devices may receive serious damage when they continue to operate over the recommended operating conditions.

## POWER DISSIPATION (DFN(PLP)1010-4B)

Power Dissipation ( $P_D$ ) of the package is dependent on PCB material, layout, and environmental conditions. The following conditions are used in this measurement.

### Measurement Conditions

|                  | Standard Land Pattern                         |
|------------------|---|
| Environment      | Mounting on Board (Wind Velocity = 0 m/s)     |
| Board Material   | Glass Cloth Epoxy Plastic (Double-sided)      |
| Board Dimensions | 40 mm x 40 mm x 1.6 mm                        |
| Copper Ratio     | Top side: Approx. 50%, Back side: Approx. 50% |
| Through-holes    | $\phi$ 0.54 mm x 24 pcs                       |

### Measurement Result:

( $T_a = 25^\circ\text{C}$ ,  $T_{j\text{max}} = 125^\circ\text{C}$ )

|                    | Standard Land Pattern  |
|--------------------|--|
| Power Dissipation  | 400 mW   |
| Thermal Resistance | $\theta_{ja} = (125 - 25^\circ\text{C}) / 0.4 \text{ W} = 250^\circ\text{C/W}$ |
|                    | $\theta_{jc} = 67^\circ\text{C/W}$   |



Power Dissipation



Measurement Board Pattern

 IC Mount Area (Unit : mm)

**POWER DISSIPATION (SOT-23-5)**

Power Dissipation ( $P_D$ ) of the package is dependent on PCB material, layout, and environmental conditions. The following conditions are used in this measurement. This data is taken from SOT-23-6.

**Measurement Conditions**

|                  | <b>Standard Land Pattern</b>                  |
|------------------|---|
| Environment      | Mounting on Board (Wind Velocity = 0 m/s)     |
| Board Material   | Glass Cloth Epoxy Plastic (Double-sided)      |
| Board Dimensions | 40 mm x 40 mm x 1.6 mm                        |
| Copper Ratio     | Top side: Approx. 50%, Back side: Approx. 50% |
| Through-holes    | $\phi$ 0.5 mm x 44 pcs                        |

**Measurement Result:**

( $T_a = 25^\circ\text{C}$ ,  $T_{j\text{max}} = 125^\circ\text{C}$ )

|                    | <b>Standard Land Pattern</b>  | <b>Free Air</b>        |
|--------------------|---|------------------------|
| Power Dissipation  | 420 mW  | 250 mW                 |
| Thermal Resistance | $\theta_{ja} = (125 - 25^\circ\text{C}) / 0.42 \text{ W} = 238^\circ\text{C/W}$ | 400 $^\circ\text{C/W}$ |



**Power Dissipation**



**Measurement Board Pattern**

IC Mount Area (Unit: mm)

## ELECTRICAL CHARACTERISTICS

The specifications surrounded by   are guaranteed by design engineering at  $-40^{\circ}\text{C} \leq T_a \leq 85^{\circ}\text{C}$ .

RP300x

( $T_a = 25^{\circ}\text{C}$ )

| Symbol                                      | Item   | Conditions  | Min.  | Typ.     | Max.  | Unit   |               |
|---|--|---|---|----------|---|--|---------------|
| $-V_{\text{DET}}^{*4}$                      | Detector Threshold<br>( $T_a = 25^{\circ}\text{C}$ )                             | $-V_{\text{SET}}^{*4} < 1.7\text{ V}$   | x0.99   |          | x1.010  | V  |               |
|   |  | $1.7\text{ V} \leq -V_{\text{SET}}$   | x0.992  |          | x1.008  | V  |               |
|   | Detector Threshold<br>( $-40^{\circ}\text{C} \leq T_a \leq 85^{\circ}\text{C}$ ) | $-V_{\text{SET}} < 1.7\text{ V}$  | <span style="border: 1px solid black; padding: 0 2px;">x0.982</span>  |          | <span style="border: 1px solid black; padding: 0 2px;">x1.018</span>  | V  |               |
|   |  | $1.7\text{ V} \leq -V_{\text{SET}}$   | <span style="border: 1px solid black; padding: 0 2px;">x0.984</span>  |          | <span style="border: 1px solid black; padding: 0 2px;">x1.016</span>  | V  |               |
| $I_{\text{SS1}}$                            | Supply Current 1   | $V_{\text{DD}} = -V_{\text{SET}} - 0.1\text{ V}$ , $I_{\text{OUT}} = 0\text{ A}$                      |   |          | 3.2   | $\mu\text{A}$  |               |
| $I_{\text{SS2}}$                            | Supply Current 2   | $V_{\text{DD}} = -V_{\text{SET}} + 0.1\text{ V}$ , $I_{\text{OUT}} = 0\text{ A}$                      |   |          | 3.1   | $\mu\text{A}$  |               |
| $V_{\text{DD}}$                             | Operating Voltage  | $T_a = 25^{\circ}\text{C}$  | 0.72  |          | 5.5   | V  |               |
|   |  | $-40^{\circ}\text{C} \leq T_a \leq 85^{\circ}\text{C}$  | <span style="border: 1px solid black; padding: 0 2px;">0.80</span>  |          | <span style="border: 1px solid black; padding: 0 2px;">5.5</span>   | V  |               |
| $I_{\text{OUT}}$                            | Output Current<br>(Driver Output Pin)  | Nch<br>$V_{\text{DD}} = -V_{\text{SET}} - 0.1\text{ V}$<br>$V_{\text{DS}} = 0.3\text{ V}$             | $-V_{\text{SET}} \geq 1.1\text{ V}$   | 0.45     |   |  | mA            |
|   |  |   | $-V_{\text{SET}} \geq 1.6\text{ V}$   | 2.5      |   |  | mA            |
|   |  |   | $-V_{\text{SET}} \geq 2.7\text{ V}$   | 4.8      |   |  | mA            |
|   |  | Nch Inverting*5<br>$V_{\text{DD}} = -V_{\text{SET}} + 0.1\text{ V}$<br>$V_{\text{DS}} = 0.3\text{ V}$ | $-V_{\text{SET}} \geq 1.1\text{ V}$   | 0.45     |   |  | mA            |
|   |  |   | $-V_{\text{SET}} \geq 1.4\text{ V}$   | 2.5      |   |  | mA            |
|   |  |   | $-V_{\text{SET}} \geq 2.5\text{ V}$   | 4.8      |   |  | mA            |
|   |  | Pch CMOS<br>$V_{\text{DD}} = -V_{\text{SET}} + 0.1\text{ V}$<br>$V_{\text{DS}} = -0.3\text{ V}$       | $-V_{\text{SET}} \geq 1.1\text{ V}$   | -0.15    |   |  | mA            |
|   |  |   | $-V_{\text{SET}} \geq 1.6\text{ V}$   | -0.45    |   |  | mA            |
|   |  |   | $-V_{\text{SET}} \geq 2.7\text{ V}$   | -0.8     |   |  | mA            |
| $I_{\text{LEAK}}$                           | Nch Driver Leakage Current   | $V_{\text{DD}} = 5.5\text{ V}$<br>$V_{\text{DS}} = 5.5\text{ V}$                                      | RP300xxxxA/C  |          |   | <span style="border: 1px solid black; padding: 0 2px;">0.15</span> | $\mu\text{A}$ |
|   |  | $V_{\text{DD}} = -V_{\text{SET}} - 0.1\text{ V}$<br>$V_{\text{DS}} = 5.5\text{ V}$                    | RP300xxxxB*6  |          |   |  |               |
| $R_{\text{MR}}$                             | MR Pin Pull-up Resistance  |   | 0.21  | 0.45     | 0.90  | $\text{M}\Omega$   |               |
| $V_{\text{IH}}$                             | MR Pin Input Voltage "H"   | $V_{\text{DD}} \geq -V_{\text{SET}} + 0.1\text{ V}$   | <span style="border: 1px solid black; padding: 0 2px;">0.75</span><br><span style="border: 1px solid black; padding: 0 2px;">xV<sub>DD</sub></span>     |          |   | V  |               |
| $V_{\text{IL}}$                             | MR Pin Input Voltage "L"   | $V_{\text{DD}} \geq -V_{\text{SET}} + 0.1\text{ V}$   |   |          | <span style="border: 1px solid black; padding: 0 2px;">0.4</span>   | V  |               |
| $t_{\text{delay}}^{*8}$                     | Released Output Delay Time   | $V_{\text{DD}} = 0.8\text{ V} \rightarrow$<br>$-V_{\text{SET}} + 1.0\text{ V}$                        | RP300xxxAx  | 47.5     | 50  | 52.5   | ms            |
|   |  |   | RP300xxxBx*7  | 95       | 100   | 105  |               |
|   |  |   | RP300xxxDx  | 190      | 200   | 210  |               |
|   |  | $-40^{\circ}\text{C} \leq T_a \leq 85^{\circ}\text{C}$  | <span style="border: 1px solid black; padding: 0 2px;">tset</span> <sup>*8</sup><br><span style="border: 1px solid black; padding: 0 2px;">x0.85</span> |          | <span style="border: 1px solid black; padding: 0 2px;">tsetx</span><br><span style="border: 1px solid black; padding: 0 2px;">1.15</span> | %  |               |
| $\frac{\Delta -V_{\text{DET}}}{\Delta T_a}$ | Detector Threshold<br>Temperature Coefficient                                    | $-40^{\circ}\text{C} \leq T_a \leq 85^{\circ}\text{C}$  |   | $\pm 50$ |   | ppm/ $^{\circ}\text{C}$  |               |

All test items listed under Electrical Characteristics are done under the pulse load condition ( $T_j \approx T_a = 25^{\circ}\text{C}$ ) except Detector Threshold Temperature Coefficient.

\*4  $-V_{\text{DET}}$  is defined as an actual detector threshold and  $-V_{\text{SET}}$  is defined as a preset detector threshold.

\*5 Nch open drain inverting output type is only applicable to the RP300xxxxB which is a custom IC.

\*6 The RP300xxxxB is a custom IC. \*7 The RP300xxxBx is a custom IC.

\*8  $t_{\text{delay}}$  is defined as an actual released output delay time and  $t_{\text{set}}$  is defined as a preset released output delay time.

TIMING CHART



Figure 6. RP300xxxxA Timing Chart



Figure 7. RP300xxxxB Timing Chart



Figure 8. RP300xxxxC Timing Chart



**Release Output Delay Time (tdelay)**

tdelay is defined as follows.

**1. Nch Open Drain Output**

Release output delay time starts after the OUT pin is pulled up to 5.5 V with a 470 kΩ resistor, and the VDD voltage is shifted from 0.8 V to -VSET + 1.0 V. It ends when the output voltage reaches 1.0 V.

**2. Nch Open Drain Inverting Output (custom IC)**

Release output delay time starts after the OUT pin is pulled up to 5.5 V with a 470 kΩ resistor, and the VDD voltage is shifted from 0.8 V to -VSET + 1.0 V. It ends when the output voltage reaches VDD / 2 V.

**3. CMOS Output**

Release output delay time starts when the VDD voltage is shifted from 0.8 V to -VSET + 1.0 V and ends when the output voltage reaches VDD / 2 V.

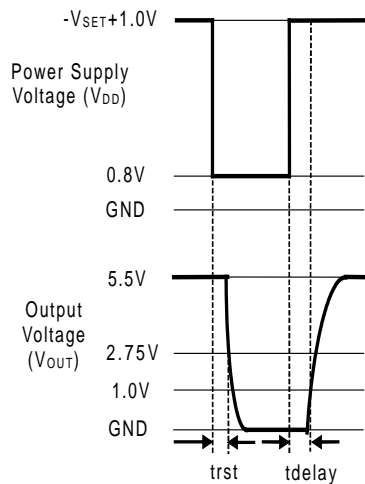

**Figure 9. Nch Open Drain Output**



**Figure 10. Nch Open Drain Inverting Output**

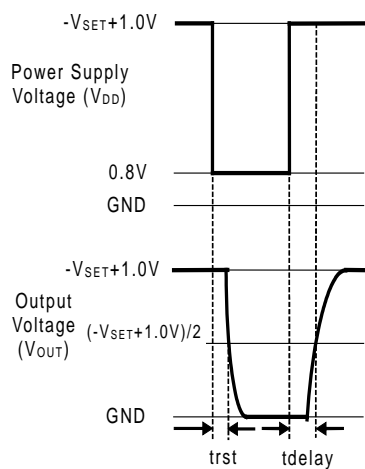

**Figure 11. CMOS Output**

**THEORY OF OPERATION**

RP300xxxxA/C



**Figure 12. Block Diagram**

- For CMOS Output, the Nch Tr. drain and the Pch Tr. drain are connected to the OUT pin inside the IC.
- For Nch Open Drain Output, the Nch Tr. drain is connected to the OUT pin inside the IC. Pull up the OUT pin or V<sub>DD</sub> pin to the external voltage level.



**Figure 13. Timing Chart (A Ver.)**



**Figure 14. Timing Chart (C Ver.)**

1. The output voltage is equalized to the V<sub>DD</sub> voltage (CMOS Output), or to the pull-up voltage (Nch Open Drain Output).
2. The V<sub>DD</sub> voltage drops to the detector threshold (A point) which means  $V_{ref} \geq V_{DD} \times R_b / (R_a + R_b)$ . The comparator output shifts from “L” to “H” voltage and the output voltage will be equalized to the GND voltage.
3. If the V<sub>DD</sub> voltage is lower than the minimum operating voltage, the output voltage becomes unstable (CMOS Output). The output voltage is equalized to the pull-up voltage (Nch Open Drain Output).
4. The output voltage is equalized to the GND voltage.
5. The V<sub>DD</sub> voltage becomes higher than the release voltage (B point) which means  $V_{ref} < V_{DD} \times R_b / (R_a + R_b)$ , and the comparator output shifts from “H” to “L” voltage, and the output voltage is equalized to the V<sub>DD</sub> voltage (CMOS Output) or to the pull-up voltage (Nch Open Drain Output).

Note: There's no hysteresis between the V<sub>DD</sub> voltage and the released voltage.

RP300xxxxB



Figure 15. Block Diagram

- The Nch Tr. drain is connected to the OUT pin inside the IC. Pull up the OUT pin or V<sub>DD</sub> pin to the external voltage level.



Figure 16. Timing Chart

1. The output voltage is equalized to the GND voltage.
2. The V<sub>DD</sub> voltage drops to the detector threshold (A point) which means  $V_{ref} \geq V_{DD} \times R_b / (R_a + R_b)$ . The comparator output shifts from “H” to “L” voltage and the output voltage shifts from the pull-up voltage to “L” voltage.
3. If the V<sub>DD</sub> voltage is lower than the minimum operating voltage, the output voltage is equalized to the pull-up voltage.
4. The output voltage is equalized to the pull-up voltage.
5. The V<sub>DD</sub> voltage becomes higher than the release voltage (B point) which means  $V_{ref} < V_{DD} \times R_b / (R_a + R_b)$ . The comparator output shifts from “L” to “H” voltage, and the output voltage is equalized to the GND voltage.

Note: There’s no hysteresis between the V<sub>DD</sub> voltage and the released voltage.

**Detector Operation vs. Glitch Input Voltage**

The RP300x has built-in rejection of fast transients on the  $V_{DD}$  pins. The rejection of transients depends on both the duration and the amplitude of the transient. The amplitude of the transient is measured from the bottom of the transient to the negative threshold voltage of the RP300x, as shown in Figure 18.



Figure 17. Minimum Pulse Duration at  $V_{DD}$  vs. Overdrive Voltage at  $V_{DD}$



Figure 18. Voltage Transient Measurement

The RP300x does not respond to transients that are fast duration/ low amplitude or long duration/ small amplitude. Figure 17 shows the relationship between the transient amplitude and duration needed to trigger a reset. Any combination of duration and amplitude above the curve generates a reset signal.

TEST CIRCUITS



Figure 19. Basic Test Circuit



Figure 20. Test Circuit for Supply Current



Figure 21. Test Circuit for Output Current



Figure 22. MR Pin Pull-up Resistor

**TYPICAL CHARACTERISTICS**

**1) Supply Current vs. Input Voltage**



**2) Detector Threshold vs. Temperature**



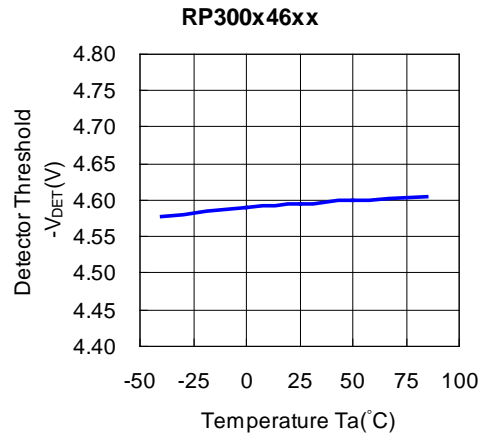

### 3) Nch Driver Output Current vs. Input Voltage

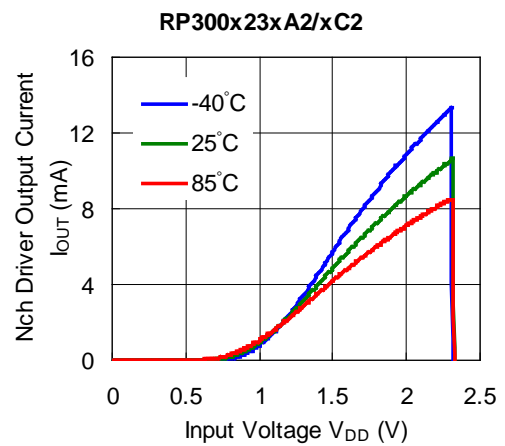

Nch Driver Inverting Output (custom IC)



4) Pch Driver Output Current vs. Input Voltage

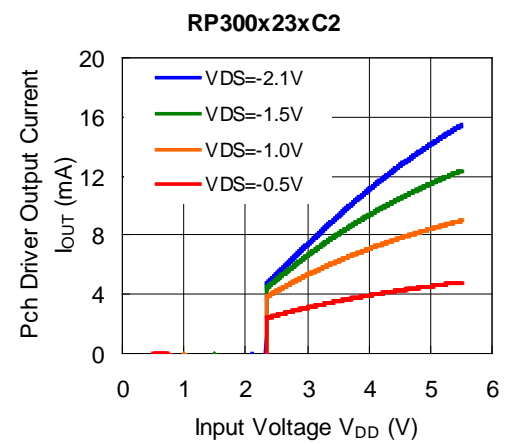





**5) Nch Driver Output Current vs. VDS**



**Nch Driver Inverting Output (custom IC)**



**6) Released Output Delay Time vs. Temperature**



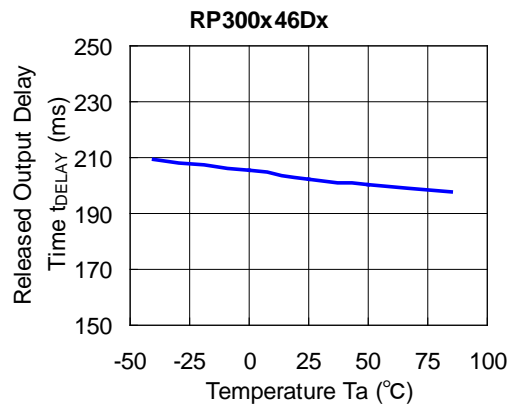

## TECHNICAL NOTES

### When connecting resistors to the device's input pin

When connecting a resistor (R1) to an input of this device, the input voltage decreases by [Device's Consumption Current] x [Resistance Value] only. And, the cross conduction current\*<sup>1</sup>, which occurs when changing from the detecting state to the release state, is decreased the input voltage by [Cross Conduction Current] x [Resistance Value] only. And then, this device will enter the re-detecting state if the input voltage reduction is larger than the difference between the detector voltage and the released voltage.

When the input resistance value is large and the VDD is gone up at mildly in the vicinity of the released voltage, repeating the above operation may result in the occurrence of output.

As shown in Figure A/B, set R1 to become 100 kΩ or less as a guide, and connect C<sub>IN</sub> of 0.1 μF and more to between the input pin and GND. Besides, make evaluations including temperature properties under the actual usage condition, with using the evaluation board like this way. As a result, make sure that the cross conduction current has no problem.



Figure A



Figure B

\*<sup>1</sup> In the CMOS output type, a charging current for OUT pin is included.

\*<sup>2</sup> Note the bias dependence of capacitors.



1. The products and the product specifications described in this document are subject to change or discontinuation of production without notice for reasons such as improvement. Therefore, before deciding to use the products, please refer to Ricoh sales representatives for the latest information thereon.
2. The materials in this document may not be copied or otherwise reproduced in whole or in part without prior written consent of Ricoh.
3. Please be sure to take any necessary formalities under relevant laws or regulations before exporting or otherwise taking out of your country the products or the technical information described herein.
4. The technical information described in this document shows typical characteristics of and example application circuits for the products. The release of such information is not to be construed as a warranty of or a grant of license under Ricoh's or any third party's intellectual property rights or any other rights.
5. The products listed in this document are intended and designed for use as general electronic components in standard applications (office equipment, telecommunication equipment, measuring instruments, consumer electronic products, amusement equipment etc.). Those customers intending to use a product in an application requiring extreme quality and reliability, for example, in a highly specific application where the failure or misoperation of the product could result in human injury or death (aircraft, spacevehicle, nuclear reactor control system, traffic control system, automotive and transportation equipment, combustion equipment, safety devices, life support system etc.) should first contact us.
6. We are making our continuous effort to improve the quality and reliability of our products, but semiconductor products are likely to fail with certain probability. In order to prevent any injury to persons or damages to property resulting from such failure, customers should be careful enough to incorporate safety measures in their design, such as redundancy feature, fire containment feature and fail-safe feature. We do not assume any liability or responsibility for any loss or damage arising from misuse or inappropriate use of the products.
7. Anti-radiation design is not implemented in the products described in this document.
8. Please contact Ricoh sales representatives should you have any questions or comments concerning the products or the technical information.



**Ricoh is committed to reducing the environmental loading materials in electrical devices with a view to contributing to the protection of human health and the environment.**

Ricoh has been providing RoHS compliant products since April 1, 2006 and Halogen-free products since April 1, 2012.

**RICOH** RICOH ELECTRONIC DEVICES CO., LTD.

<http://www.e-devices.ricoh.co.jp/en/>

#### Sales & Support Offices

##### **RICOH ELECTRONIC DEVICES CO., LTD.**

**Higashi-Shinagawa Office (International Sales)**  
3-32-3, Higashi-Shinagawa, Shinagawa-ku, Tokyo 140-8655, Japan  
Phone: +81-3-5479-2857 Fax: +81-3-5479-0502

##### **RICOH EUROPE (NETHERLANDS) B.V.**

**Semiconductor Support Centre**  
Prof. W.H. Keesomlaan 1, 1183 DJ Amstelveen, The Netherlands  
Phone: +31-20-5474-309

##### **RICOH INTERNATIONAL B.V. - German Branch**

**Semiconductor Sales and Support Centre**  
Oberrather Strasse 6, 40472 Düsseldorf, Germany  
Phone: +49-211-6546-0

##### **RICOH ELECTRONIC DEVICES KOREA CO., LTD.**

3F, Haesung Bldg, 504, Teheran-ro, Gangnam-gu, Seoul, 135-725, Korea  
Phone: +82-2-2135-5700 Fax: +82-2-2051-5713

##### **RICOH ELECTRONIC DEVICES SHANGHAI CO., LTD.**

Room 403, No.2 Building, No.690 Bibo Road, Pu Dong New District, Shanghai 201203, People's Republic of China  
Phone: +86-21-5027-3200 Fax: +86-21-5027-3299

##### **RICOH ELECTRONIC DEVICES CO., LTD.**

**Taipei office**  
Room 109, 10F-1, No.51, Hengyang Rd., Taipei City, Taiwan (R.O.C.)  
Phone: +886-2-2313-1621/1622 Fax: +886-2-2313-1623

# Mouser Electronics

Authorized Distributor

Click to View Pricing, Inventory, Delivery & Lifecycle Information:

## Ricoh Electronics:

[RP300N23AA2-TR-FE](#) [RP300N29DC3-TR-FE](#) [RP300N26DA3-TR-FE](#) [RP300N29AA3-TR-FE](#) [RP300N28DA-TR-FE](#)  
[RP300N30DC8-TR-FE](#) [RP300N27DA-TR-FE](#) [RP300N28DC-TR-FE](#) [RP300N43AC8-TR-FE](#) [RP300N11AC-TR-FE](#)  
[RP300N27AA-TR-FE](#) [RP300N28AC-TR-FE](#) [RP300N28AA-TR-FE](#) [RP300N46AC-TR-FE](#) [RP300N29DA3-TR-FE](#)  
[RP300N11DA-TR-FE](#) [RP300N27DC-TR-FE](#) [RP300N43DC8-TR-FE](#) [RP300N46DC-TR-FE](#) [RP300N26DC3-TR-FE](#)  
[RP300N30AC8-TR-FE](#) [RP300N27AC-TR-FE](#) [RP300N46DA-TR-FE](#) [RP300N23DA2-TR-FE](#) [RP300N23DC2-TR-FE](#)  
[RP300N29AC3-TR-FE](#) [RP300N26AA3-TR-FE](#) [RP300N46AA-TR-FE](#) [RP300N43AA8-TR-FE](#) [RP300N26AC3-TR-FE](#)  
[RP300N11DC-TR-FE](#) [RP300N30AA8-TR-FE](#) [RP300N30DA8-TR-FE](#) [RP300N11AA-TR-FE](#) [RP300N43DA8-TR-FE](#)  
[RP300N23AC2-TR-FE](#)

## Данный компонент на территории Российской Федерации

### Вы можете приобрести в компании MosChip.

Для оперативного оформления запроса Вам необходимо перейти по данной ссылке:

<http://moschip.ru/get-element>

Вы можете разместить у нас заказ для любого Вашего проекта, будь то серийное производство или разработка единичного прибора.

В нашем ассортименте представлены ведущие мировые производители активных и пассивных электронных компонентов.

Нашей специализацией является поставка электронной компонентной базы двойного назначения, продукции таких производителей как XILINX, Intel (ex.ALTERA), Vicor, Microchip, Texas Instruments, Analog Devices, Mini-Circuits, Amphenol, Glenair.

Сотрудничество с глобальными дистрибьюторами электронных компонентов, предоставляет возможность заказывать и получать с международных складов практически любой перечень компонентов в оптимальные для Вас сроки.

На всех этапах разработки и производства наши партнеры могут получить квалифицированную поддержку опытных инженеров.

Система менеджмента качества компании отвечает требованиям в соответствии с ГОСТ Р ИСО 9001, ГОСТ РВ 0015-002 и ЭС РД 009

### Офис по работе с юридическими лицами:

105318, г.Москва, ул.Щербаковская д.3, офис 1107, 1118, ДЦ «Щербаковский»

Телефон: +7 495 668-12-70 (многоканальный)

Факс: +7 495 668-12-70 (доб.304)

E-mail: [info@moschip.ru](mailto:info@moschip.ru)

Skype отдела продаж:

moschip.ru

moschip.ru\_4

moschip.ru\_6

moschip.ru\_9