

## ST Step Drive Family



### ST Step Drive Family

The STM is part of a larger family of step drives sharing a common configuration interface and all supporting common programming languages and tools.

The family consist of :

**STAC6 models** - Available in 110VAC and 220VAC input versions. This offers the highest power output, driving even the largest HT34 motors to their full potential.

It also features RS-485 connection and encoder input as standard. The 110VAC version has UL recognition.

**ST-Q/SI models** - 5 or 10A versions with bus voltages to 80V. Offered in a number of build options, including the addition of encoder feedback and RS-485.

**ST-S models** - 5A or 10A versions, bus voltages to 80VDC, offered in a compact 3.65" x 3.0" x 1.125" package. This is the step and direction input model for OEM applications.

For more information or to download a brochure, please visit our website.



404 Westridge Dr.  
Watsonville, CA 95076  
Tel: 800-525-1609  
Fax: 831-761-6544  
www.applied-motion.com

DISTRIBUTED BY:

# STM Drive+Motor

The STM is a Drive+Motor unit, fusing step motor and drive technologies into a single device, offering savings on space, wiring and cost over conventional motor and drive solutions. The STM also fits with the ST product family of step motors and drives for a complete motion control system.



**Drive** + **Motor** + **Control**

### Specifications

#### OUTPUT TORQUE:

- STM23x-2 - to 125 oz-in
- STM23x-3 - to 210 oz-in

#### PROTECTION:

- Over-Voltage
- Under voltage
- Over-Temp
- Motor Shorts
- Motor Open Phase

- ✓ **Dynamic Current Control**
- ✓ **Anti-Resonance**
- ✓ **Torque Ripple Smoothing**
- ✓ **Microstep Emulation**

### Models

- Pulse & Direction
- CW/CCW Pulse
- A/B Quadrature
- Velocity (Oscillator) mode
- Host commands (SCL compatible)
- SiNet Hub compatible
- ST Configurator software for setup

S

Q

- Stand-alone Operation
- Q Programmer for complex motion
- Conditional Processing
- Math Functions
- Multi-tasking
- Register Manipulation
- Encoder Following
- "Generic" HMI compatibility

### Ordering

## STM23S-2AN

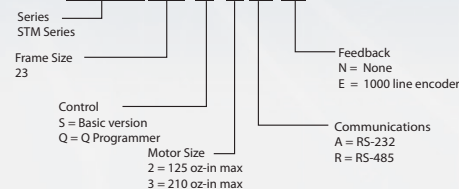

## STM technical specs.

### POWER AMPLIFIER: All Models

|                        |  |
|------------------------|--|
| AMPLIFIER TYPE         | Dual H-Bridge, 4 Quadrant  |
| CURRENT CONTROL        | 4 state PWM at 20 KHz  |
| OUTPUT TORQUE          | <b>STM23x-2 Series</b> - TO 125 OZ.IN WITH SUITABLE POWER SUPPLY<br><b>STM23x-3 Series</b> - TO 210 OZ.IN WITH SUITABLE POWER SUPPLY |
| POWER SUPPLY           | External 12 - 70 VDC Power Supply Required   |
| INPUT VOLTAGE RANGE    | 24 - 75 VDC  |
| PROTECTION             | Over-Voltage, Under-voltage, Over-Temp, Motor/wiring shorts (Phase-to-Phase, Phase-to-Ground).                                       |
| IDLE CURRENT REDUCTION | Reduction range of 0 - 90% of Running Current after delay selectable in milliseconds.  |
| AMBIENT TEMPERATURE    | 0 to 40 °C (32 - 104 °F) (mounted to suitable heatsink)  |
| HUMIDITY               | 90% non-condensing.  |

### CONTROLLER: All Models

|                                     |  |
|-------------------------------------|--|
| MICROSTEP RESOLUTION                | Software selectable from 200 to 51200 steps/rev in increments of 2 steps/rev.  |
| ANTI-RESONANCE (Electronic Damping) | Raises the system damping ratio to eliminate midrange instability and allow stable operation throughout the speed range and improves settling time.                                    |
| TORQUE RIPPLE SMOOTHING             | Allows for fine adjustment of phase current waveform harmonic content to reduce low-speed torque ripple in the range 0.25 to 1.5 rps   |
| AUTO SETUP                          | Measures motor parameters and configures motor current control and anti-resonance gain settings  |
| SELF TEST                           | Checks Internal & External Power supply voltages. Diagnoses open motor phases and motor resistance changes >40%. Detects encoder wiring and signal faults (differential encoder only). |
| MICROSTEP EMULATION                 | Performs high resolution stepping by synthesizing fine microsteps from coarse steps (Step & Direction Mode Only) .   |
| COMMAND SIGNAL SMOOTHING            | Software configurable filtering reduces jerk and excitation of extraneous system resonances (Step & Direction Mode Only).  |

### CONTROLLER: S Models

|                           |   |
|---------------------------|---|
| NON-VOLATILE STORAGE      | Configurations are saved in FLASH memory on-board the DSP.  |
| MODE OF OPERATION         | Step & Direction, CW/CCW, A/B Quadrature, Oscillator, Joystick, SCL, Hub.   |
| STEP AND DIRECTION INPUTS | STEP +/-<br>Optically Isolated, 5-24 Volt. Minimum pulse width = 250 ns. Maximum pulse frequency = 3MHz.<br>Function: Step, CW Step, A Quadrature, Encoder Following, CW Limit , CW Jog, START/STOP (Oscillator mode), DIR +/-<br>Optically Isolated, 5-24 Volt. Minimum pulse width = 250 ns. Maximum pulse frequency = 3 MHz.<br>Function: DIR, CCW Step, B Quadrature, Encoder Following, CCW Limit , CCW Jog, Sensor, DIR (Oscillator mode),<br><br>Adjustable bandwidth digital noise rejection filter on all inputs |
| ENABLE INPUT              | EN +/-<br>Optically Isolated, 5-24 Volt. Minimum pulse width = 250 ns. Maximum pulse frequency = 3 MHz.<br>Function: ENABLE, RESET , SPEED 1/SPEED 2 (Oscillator mode)  |
| OUTPUT                    | Optically Isolated, 24V, 40mA MAX.<br>Function: Fault, Motion, Tach.  |
| ANALOG INPUT RANGE        | 0 to 5VDC   |
| ANALOG INPUT RESOLUTION   | 12 bits   |
| COMMUNICATION INTERFACE   | RS-232 or RS-485  |

## STM23-2 TORQUE CURVES

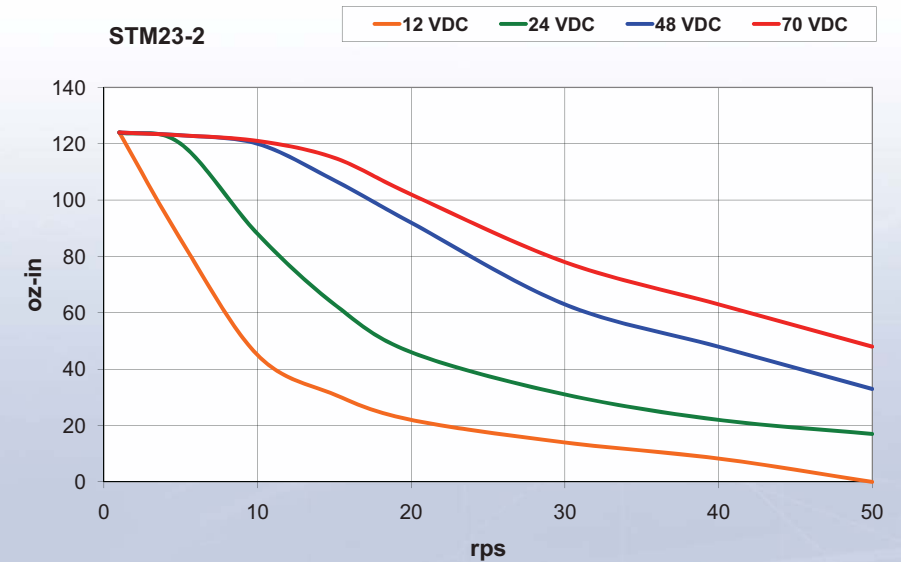

## STM23-3 TORQUE CURVES

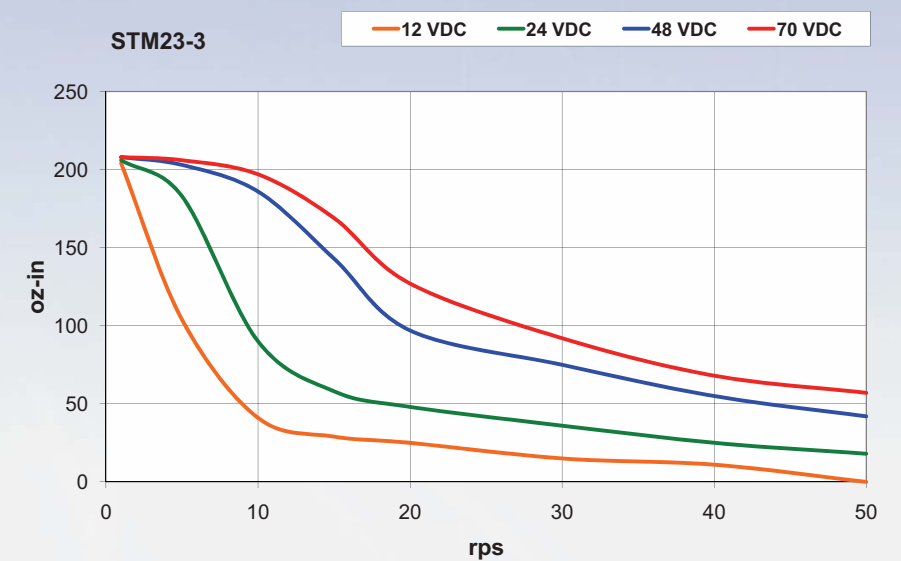

## Connections

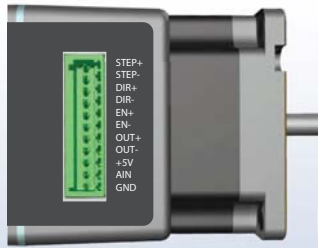

Input/Output connections

## Inputs & Outputs

S

3 digital inputs  
1 digital output  
1 analog input

Q

3 digital inputs  
1 digital output  
1 analog input

## Software

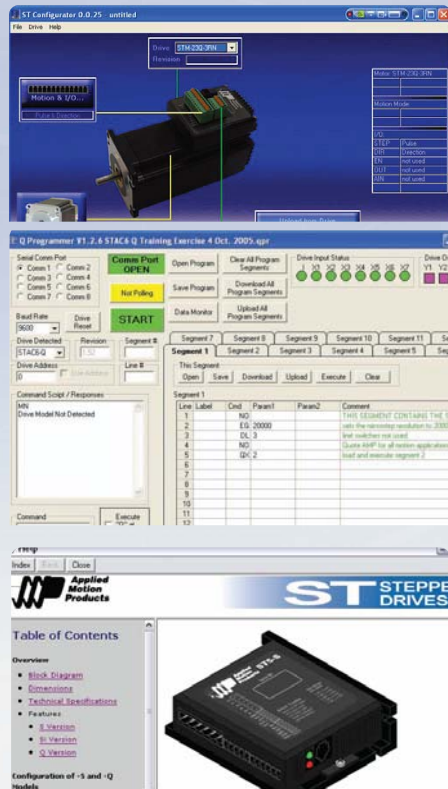

### ST Configurator

Used for setup and configuration of the drive+motor. For more information about the ST Configurator visit the Applied Motion Products Website

### Q Programmer

Q Programmer is used to create and edit stand-alone programs for Q version drives. The functions of these drives include multi-tasking, math, register manipulation, encoder following, and more.

### Help Manuals

ST Configurator incorporates new on-line help menus. All the technical data, application information and advice on setting up the drive is now just a mouse click away.

All software applications run on Windows Vista, XP, 2000, NT, ME, 98.

## STM technical specs (cont)

### CONTROLLER: Q Models

|                         |  |
|-------------------------|--|
| NON-VOLATILE STORAGE    | Programs, Data and drive configuration are saved in FLASH and EEPROM memory  |
| INPUTS                  | <p>STEP +/-<br/>Optically Isolated, 5-24 Volt. Minimum pulse width = 250 ns. Maximum pulse frequency = 3 MHz.<br/>Function: Step, CW Step, A Quadrature, Encoder Following, CW Limit , CW Jog, START/STOP ( Oscillator mode), General Purpose Input.</p> <p>DIR +/-<br/>Optically Isolated, 5-24 Volt. Minimum pulse width = 250 ns. Maximum pulse frequency = 3 MHz.<br/>Function: DIR, CCW Step, B Quadrature, Encoder Following, CCW Limit , CCW Jog, Sensor, DIR (Oscillator mode), General Purpose Input.</p> <p>EN +/-<br/>Optically Isolated, 5-24 Volt. Minimum pulse width = 250 ns. Maximum pulse frequency = 3 MHz.<br/>Function: ENABLE, RESET , SPEED 1 /SPEED 2 (Oscillator mode), General Purpose Input.</p> <p>Adjustable bandwidth digital noise rejection filter on all inputs</p> |
| OUTPUT                  | <p>Optically Isolated, 24V, 40mA MAX. NPN/sinking.<br/>Function: Fault, Motion, Tach or general purpose programmable</p>   |
| ANALOG INPUT RANGE      | 0 - 5 VDC  |
| ANALOG INPUT RESOLUTION | 12 bits  |
| COMMUNICATION INTERFACE | RS-232 OR RS-485   |
| AGENCY APPROVALS        | <p>RoHS<br/>CE, EN 61800-3 :2004, EN 61800-5-1 :2003</p>   |

## Dimensions

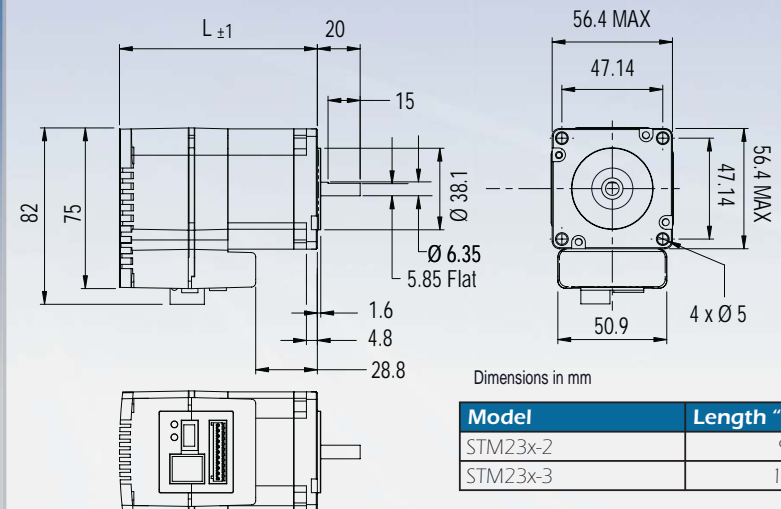

Dimensions in mm

| Model    | Length "L" mm |
|----------|---------------|
| STM23x-2 | 92.4          |
| STM23x-3 | 114.4         |

### Anti-Resonance/Electronic Damping

Step motor systems have a natural tendency to resonate at certain speeds. The STM drive+motor automatically calculates the system's natural frequency and apply damping to the control algorithm. This greatly improves midrange stability, allows higher speeds and greater torque utilization, and also improves settling times.

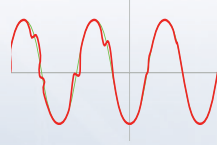

**Delivers better motor performance and higher speeds**

### Microstep Emulation

With Microstep Emulation, low resolution systems can still provide smooth motion. The drive can take low-resolution step pulses and create fine resolution micro-step motion.

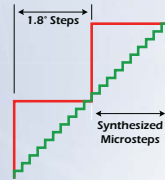

**Delivers smoother motion in any application**

### Torque Ripple Smoothing

All step motors have an inherent low speed torque ripple that can affect the motion of the motor. By analyzing this torque ripple the system can apply a negative harmonic to negate this effect, which gives the motor much smoother motion at low speed.

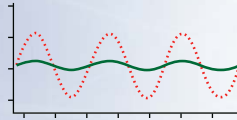

**Delivers smoother motion at lower speeds**

### Command Signal Smoothing

Command Signal smoothing can soften the effect of immediate changes in velocity and direction, making the motion of the motor less jerky. An added advantage is that it can reduce the wear on mechanical components.

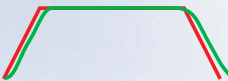

**Delivers smoother system performance**

### Dynamic Current Control

Allows for three current settings to help the motor run cooler and reduce power consumption.

- Running Current - the current the drive will deliver for continuous motion.
- Accel Current - the current the drive will deliver when accelerating or decelerating.
- Idle Current - reduces current draw when motor is stationary.

**System Runs Cooler**

### Self Test & Auto Setup

At start-up the drive measures motor parameters, including the resistance and inductance, then uses this information to optimize the system performance.

For more information go to [www.applied-motion.com/STM](http://www.applied-motion.com/STM)



RS232 Model



RS485 Model

## Encoder Option

The STM drive+motor is offered with an optional 1000 line encoder that is integrated into the housing of the motor, without increasing the size of the unit.

The encoder feedback option provides the following functionality:

- **Stall Detection:** The drive detects if the motor has stalled and triggers a fault.
- **Stall Prevention:** The drive automatically senses rotor lag and reduces motor speed to avoid stalling. This feature also includes Position Maintenance which is used when the motor is stopped.

### Step & Direction

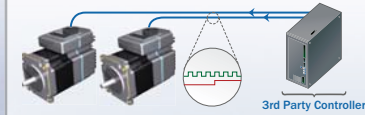

- Step & Direction
- CW & CCW Pulse
- A/B Quadrature (Master Encoder)

### Oscillator / Run-Stop

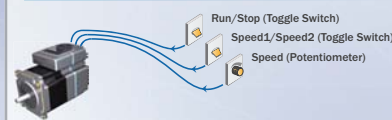

- Software Configuration
- Two Speeds
- Vary speed with analog input
- Joystick Compatible

### Host Control

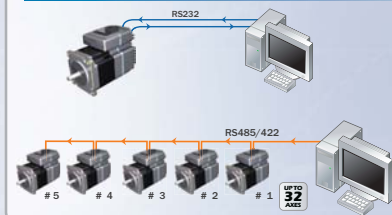

- RS-232 Model
  - Accepts Serial Commands from host PC or PLC
- RS-485 Model
  - Accepts Serial Commands from host PC or PLC
  - Multi-axis Capable

### Stand-Alone Programmable

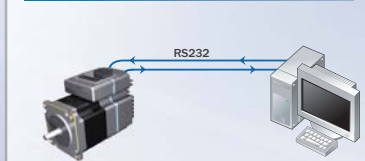

- Comprehensive text based language
- Download, store & execute programs
- High Level Features: Multi-Tasking, Conditional Programming, & Math Functions
- Host Interface While Executing Internal programs

### Multi-axis Systems

Use SiNet Hub Programmer software to develop your sequence of events, then download them to a SiNet Hub for a stand-alone system or stream serial commands to the drives from a PC, PLC, HMI, or other host controller.

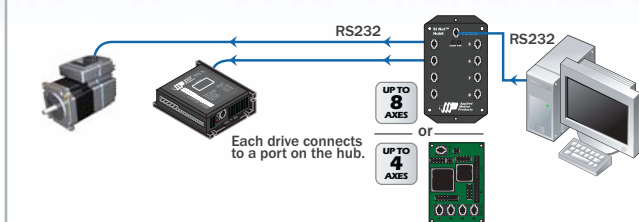

## Данный компонент на территории Российской Федерации

### Вы можете приобрести в компании MosChip.

Для оперативного оформления запроса Вам необходимо перейти по данной ссылке:

<http://moschip.ru/get-element>

Вы можете разместить у нас заказ для любого Вашего проекта, будь то серийное производство или разработка единичного прибора.

В нашем ассортименте представлены ведущие мировые производители активных и пассивных электронных компонентов.

Нашей специализацией является поставка электронной компонентной базы двойного назначения, продукции таких производителей как XILINX, Intel (ex.ALTERA), Vicor, Microchip, Texas Instruments, Analog Devices, Mini-Circuits, Amphenol, Glenair.

Сотрудничество с глобальными дистрибьюторами электронных компонентов, предоставляет возможность заказывать и получать с международных складов практически любой перечень компонентов в оптимальные для Вас сроки.

На всех этапах разработки и производства наши партнеры могут получить квалифицированную поддержку опытных инженеров.

Система менеджмента качества компании отвечает требованиям в соответствии с ГОСТ Р ИСО 9001, ГОСТ РВ 0015-002 и ЭС РД 009

### Офис по работе с юридическими лицами:

105318, г.Москва, ул.Щербаковская д.3, офис 1107, 1118, ДЦ «Щербаковский»

Телефон: +7 495 668-12-70 (многоканальный)

Факс: +7 495 668-12-70 (доб.304)

E-mail: [info@moschip.ru](mailto:info@moschip.ru)

Skype отдела продаж:

moschip.ru

moschip.ru\_4

moschip.ru\_6

moschip.ru\_9