

MOSFET

Metal Oxide Semiconductor Field Effect Transistor

CoolMOS™ C7

650V CoolMOS™ C7 Power Transistor
IPP65R045C7

Data Sheet

Rev. 2.1
Final

1 Description

CoolMOS™ is a revolutionary technology for high voltage power MOSFETs, designed according to the superjunction (SJ) principle and pioneered by Infineon Technologies.

CoolMOS™ C7 series combines the experience of the leading SJ MOSFET supplier with high class innovation. The product portfolio provides all benefits of fast switching superjunction MOSFETs offering better efficiency, reduced gate charge, easy implementation and outstanding reliability.

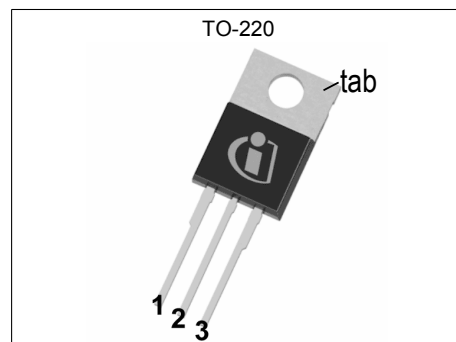

Features

- Increased MOSFET dv/dt ruggedness
- Better efficiency due to best in class FOM $R_{DS(on)} \cdot E_{oss}$ and $R_{DS(on)} \cdot Q_g$
- Best in class $R_{DS(on)}$ /package
- Easy to use/drive
- Pb-free plating, halogen free mold compound
- Qualified for industrial grade applications according to JEDEC (J-STD20 and JESD22)

Benefits

- Enabling higher system efficiency
- Enabling higher frequency / increased power density solutions
- System cost / size savings due to reduced cooling requirements
- Higher system reliability due to lower operating temperatures

Applications

PFC stages and hard switching PWM stages for e.g. Computing, Server, Telecom, UPS and Solar.

Please note: For MOSFET paralleling the use of ferrite beads on the gate or separate totem poles is generally recommended.

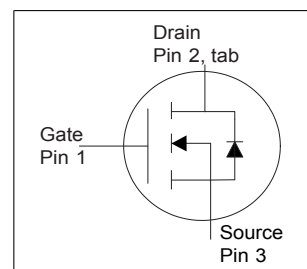

Table 1 Key Performance Parameters

| Parameter | Value | Unit |
|----------------------|-------|------|
| $V_{DS} @ T_{j,max}$ | 700 | V |
| $R_{DS(on),max}$ | 45 | mΩ |
| $Q_{g,typ}$ | 93 | nC |
| $I_{D,pulse}$ | 212 | A |
| $E_{oss@400V}$ | 11.7 | μJ |
| Body diode di/dt | 60 | A/μs |

| Type / Ordering Code | Package | Marking | Related Links |
|----------------------|-----------|---------|----------------|
| IPP65R045C7 | PG-TO 220 | 65C7045 | see Appendix A |

Table of Contents

| | |
|---|----|
| Description | 2 |
| Maximum ratings | 4 |
| Thermal characteristics | 5 |
| Electrical characteristics | 6 |
| Electrical characteristics diagrams | 8 |
| Test Circuits | 12 |
| Package Outlines | 13 |
| Appendix A | 14 |
| Revision History | 15 |
| Disclaimer | 15 |

2 Maximum ratings

at $T_j = 25^\circ\text{C}$, unless otherwise specified

Table 2 Maximum ratings

| Parameter | Symbol | Values | | | Unit | Note / Test Condition |
|--|---------------|--------|------|----------|------------------|--|
| | | Min. | Typ. | Max. | | |
| Continuous drain current ¹⁾ | I_D | - | - | 46 29 | A | $T_C=25^\circ\text{C}$ $T_C=100^\circ\text{C}$ |
| Pulsed drain current ²⁾ | $I_{D,pulse}$ | - | - | 212 | A | $T_C=25^\circ\text{C}$ |
| Avalanche energy, single pulse | E_{AS} | - | - | 249 | mJ | $I_D=12\text{A}; V_{DD}=50\text{V}$ |
| Avalanche energy, repetitive | E_{AR} | - | - | 1.25 | mJ | $I_D=12\text{A}; V_{DD}=50\text{V}$ |
| Avalanche current, single pulse | I_{AS} | - | - | 12.0 | A | - |
| MOSFET dv/dt ruggedness | dv/dt | - | - | 100 | V/ns | $V_{DS}=0\dots400\text{V}$ |
| Gate source voltage (static) | V_{GS} | -20 | - | 20 | V | static; |
| Gate source voltage (dynamic) | V_{GS} | -30 | - | 30 | V | AC (f>1 Hz) |
| Power dissipation | P_{tot} | - | - | 227 | W | $T_C=25^\circ\text{C}$ |
| Storage temperature | T_{stg} | -55 | - | 150 | $^\circ\text{C}$ | - |
| Operating junction temperature | T_j | -55 | - | 150 | $^\circ\text{C}$ | - |
| Mounting torque | - | - | - | 60 | Ncm | M3 and M3.5 screws |
| Continuous diode forward current | I_S | - | - | 46 | A | $T_C=25^\circ\text{C}$ |
| Diode pulse current ²⁾ | $I_{S,pulse}$ | - | - | 212 | A | $T_C=25^\circ\text{C}$ |
| Reverse diode dv/dt ³⁾ | dv/dt | - | - | 1.5 | V/ns | $V_{DS}=0\dots400\text{V}, I_{SD}\leq I_S, T_j=25^\circ\text{C}$ |
| Maximum diode commutation speed | di/dt | - | - | 60 | A/ μs | $V_{DS}=0\dots400\text{V}, I_{SD}\leq I_S, T_j=25^\circ\text{C}$ |
| Insulation withstand voltage | V_{ISO} | - | - | n.a. | V | $V_{rms}, T_C=25^\circ\text{C}, t=1\text{min}$ |

¹⁾ Limited by $T_{j,max}$.

²⁾ Pulse width t_p limited by $T_{j,max}$

³⁾ Identical low side and high side switch with identical R_G

3 Thermal characteristics

Table 3 Thermal characteristics

| Parameter | Symbol | Values | | | Unit | Note / Test Condition |
|--|------------|--------|------|------|------|-------------------------------------|
| | | Min. | Typ. | Max. | | |
| Thermal resistance, junction - case | R_{thJC} | - | - | 0.55 | °C/W | - |
| Thermal resistance, junction - ambient | R_{thJA} | - | - | 62 | °C/W | leaded |
| Thermal resistance, junction - ambient for SMD version | R_{thJA} | - | - | - | °C/W | n.a. |
| Soldering temperature, wavesoldering only allowed at leads | T_{sold} | - | - | 260 | °C | 1.6mm (0.063 in.) from case for 10s |

4 Electrical characteristics

at $T_j=25^\circ\text{C}$, unless otherwise specified

Table 4 Static characteristics

| Parameter | Symbol | Values | | | Unit | Note / Test Condition |
|----------------------------------|---------------|--------|----------------|------------|---------------|---|
| | | Min. | Typ. | Max. | | |
| Drain-source breakdown voltage | $V_{(BR)DSS}$ | 650 | - | - | V | $V_{GS}=0\text{V}$, $I_D=1\text{mA}$ |
| Gate threshold voltage | $V_{(GS)th}$ | 3 | 3.5 | 4 | V | $V_{DS}=V_{GS}$, $I_D=1.25\text{mA}$ |
| Zero gate voltage drain current | I_{DSS} | - | - | 2 | μA | $V_{DS}=650$, $V_{GS}=0\text{V}$, $T_j=25^\circ\text{C}$ $V_{DS}=650$, $V_{GS}=0\text{V}$, $T_j=150^\circ\text{C}$ |
| Gate-source leakage current | I_{GSS} | - | - | 100 | nA | $V_{GS}=20\text{V}$, $V_{DS}=0\text{V}$ |
| Drain-source on-state resistance | $R_{DS(on)}$ | - | 0.040 0.096 | 0.045 - | Ω | $V_{GS}=10\text{V}$, $I_D=24.9\text{A}$, $T_j=25^\circ\text{C}$ $V_{GS}=10\text{V}$, $I_D=24.9\text{A}$, $T_j=150^\circ\text{C}$ |
| Gate resistance | R_G | - | 0.85 | - | Ω | $f=1\text{MHz}$, open drain |

Table 5 Dynamic characteristics

| Parameter | Symbol | Values | | | Unit | Note / Test Condition |
|--|--------------|--------|------|------|------|--|
| | | Min. | Typ. | Max. | | |
| Input capacitance | C_{iss} | - | 4340 | - | pF | $V_{GS}=0\text{V}$, $V_{DS}=400\text{V}$, $f=250\text{kHz}$ |
| Output capacitance | C_{oss} | - | 70 | - | pF | $V_{GS}=0\text{V}$, $V_{DS}=400\text{V}$, $f=250\text{kHz}$ |
| Effective output capacitance, energy related ¹⁾ | $C_{o(er)}$ | - | 146 | - | pF | $V_{GS}=0\text{V}$, $V_{DS}=0\dots400\text{V}$ |
| Effective output capacitance, time related ²⁾ | $C_{o(tr)}$ | - | 1630 | - | pF | $I_D=\text{constant}$, $V_{GS}=0\text{V}$, $V_{DS}=0\dots400\text{V}$ |
| Turn-on delay time | $t_{d(on)}$ | - | 20 | - | ns | $V_{DD}=400\text{V}$, $V_{GS}=13\text{V}$, $I_D=24.9\text{A}$, $R_G=3.3\Omega$ |
| Rise time | t_r | - | 14 | - | ns | $V_{DD}=400\text{V}$, $V_{GS}=13\text{V}$, $I_D=24.9\text{A}$, $R_G=3.3\Omega$ |
| Turn-off delay time | $t_{d(off)}$ | - | 82 | - | ns | $V_{DD}=400\text{V}$, $V_{GS}=13\text{V}$, $I_D=24.9\text{A}$, $R_G=3.3\Omega$ |
| Fall time | t_f | - | 7 | - | ns | $V_{DD}=400\text{V}$, $V_{GS}=13\text{V}$, $I_D=24.9\text{A}$, $R_G=3.3\Omega$ |

Table 6 Gate charge characteristics

| Parameter | Symbol | Values | | | Unit | Note / Test Condition |
|-----------------------|---------------|--------|------|------|------|--|
| | | Min. | Typ. | Max. | | |
| Gate to source charge | Q_{gs} | - | 23 | - | nC | $V_{DD}=400\text{V}$, $I_D=24.9\text{A}$, $V_{GS}=0$ to 10V |
| Gate to drain charge | Q_{gd} | - | 30 | - | nC | $V_{DD}=400\text{V}$, $I_D=24.9\text{A}$, $V_{GS}=0$ to 10V |
| Gate charge total | Q_g | - | 93 | - | nC | $V_{DD}=400\text{V}$, $I_D=24.9\text{A}$, $V_{GS}=0$ to 10V |
| Gate plateau voltage | $V_{plateau}$ | - | 5.4 | - | V | $V_{DD}=400\text{V}$, $I_D=24.9\text{A}$, $V_{GS}=0$ to 10V |

¹⁾ $C_{o(er)}$ is a fixed capacitance that gives the same stored energy as C_{oss} while V_{DS} is rising from 0 to 400V

²⁾ $C_{o(tr)}$ is a fixed capacitance that gives the same charging time as C_{oss} while V_{DS} is rising from 0 to 400V

Table 7 Reverse diode characteristics

| Parameter | Symbol | Values | | | Unit | Note / Test Condition |
|-------------------------------|-----------|--------|------|------|---------|--|
| | | Min. | Typ. | Max. | | |
| Diode forward voltage | V_{SD} | - | 0.9 | - | V | $V_{GS}=0V, I_F=24.9A, T_j=25^\circ C$ |
| Reverse recovery time | t_{rr} | - | 725 | - | ns | $V_R=400V, I_F=46A, di_F/dt=60A/\mu s$ |
| Reverse recovery charge | Q_{rr} | - | 13 | - | μC | $V_R=400V, I_F=46A, di_F/dt=60A/\mu s$ |
| Peak reverse recovery current | I_{rrm} | - | 36 | - | A | $V_R=400V, I_F=46A, di_F/dt=60A/\mu s$ |

5 Electrical characteristics diagrams

Table 8

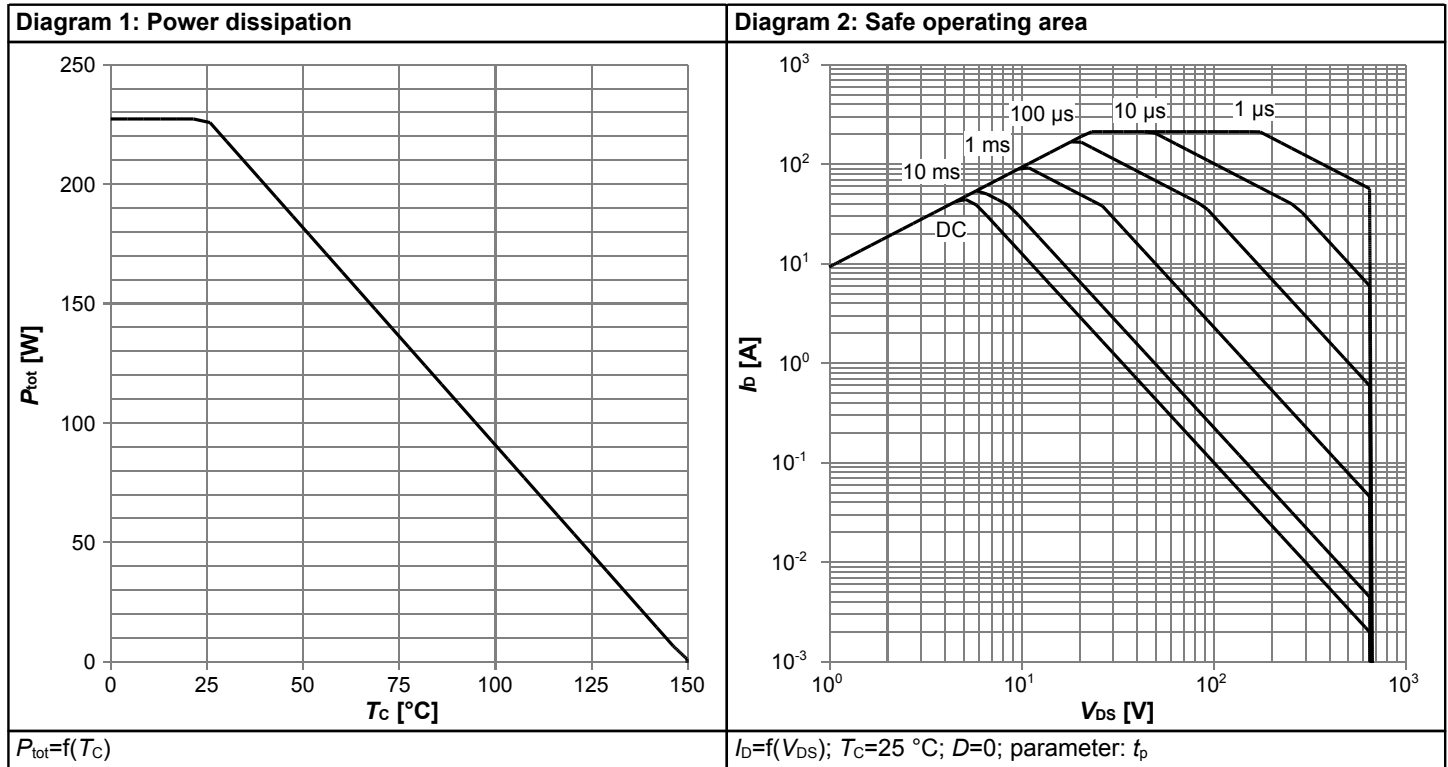

Table 9

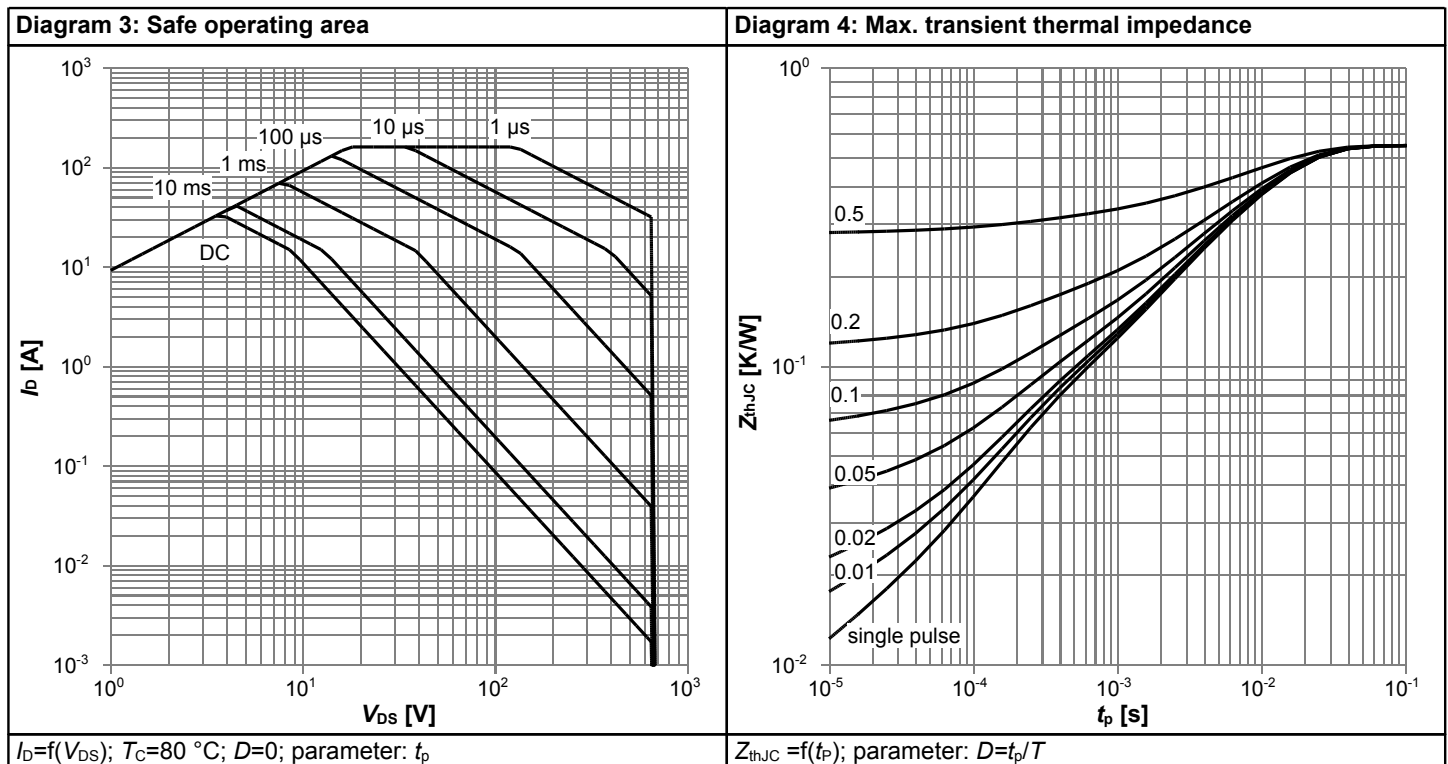

Table 10

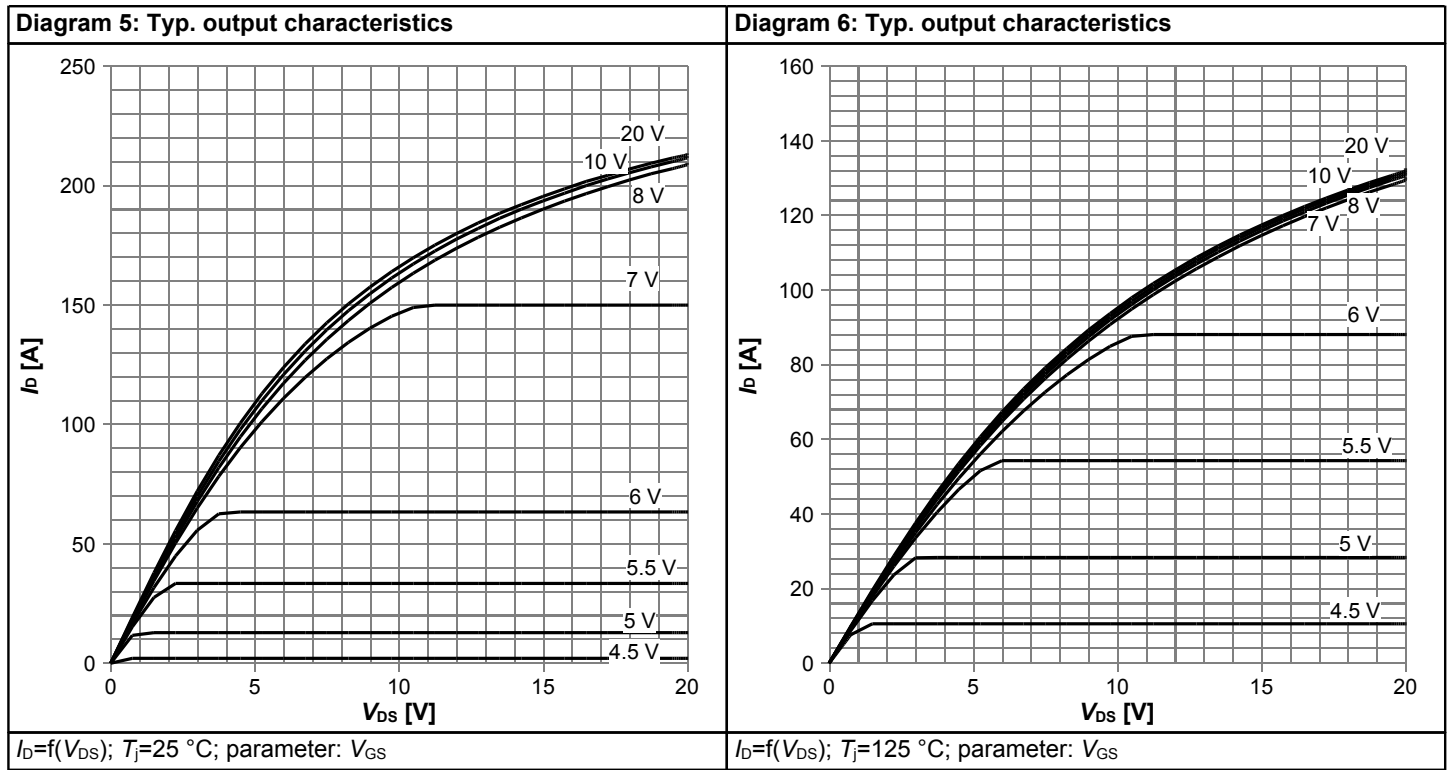

Table 11

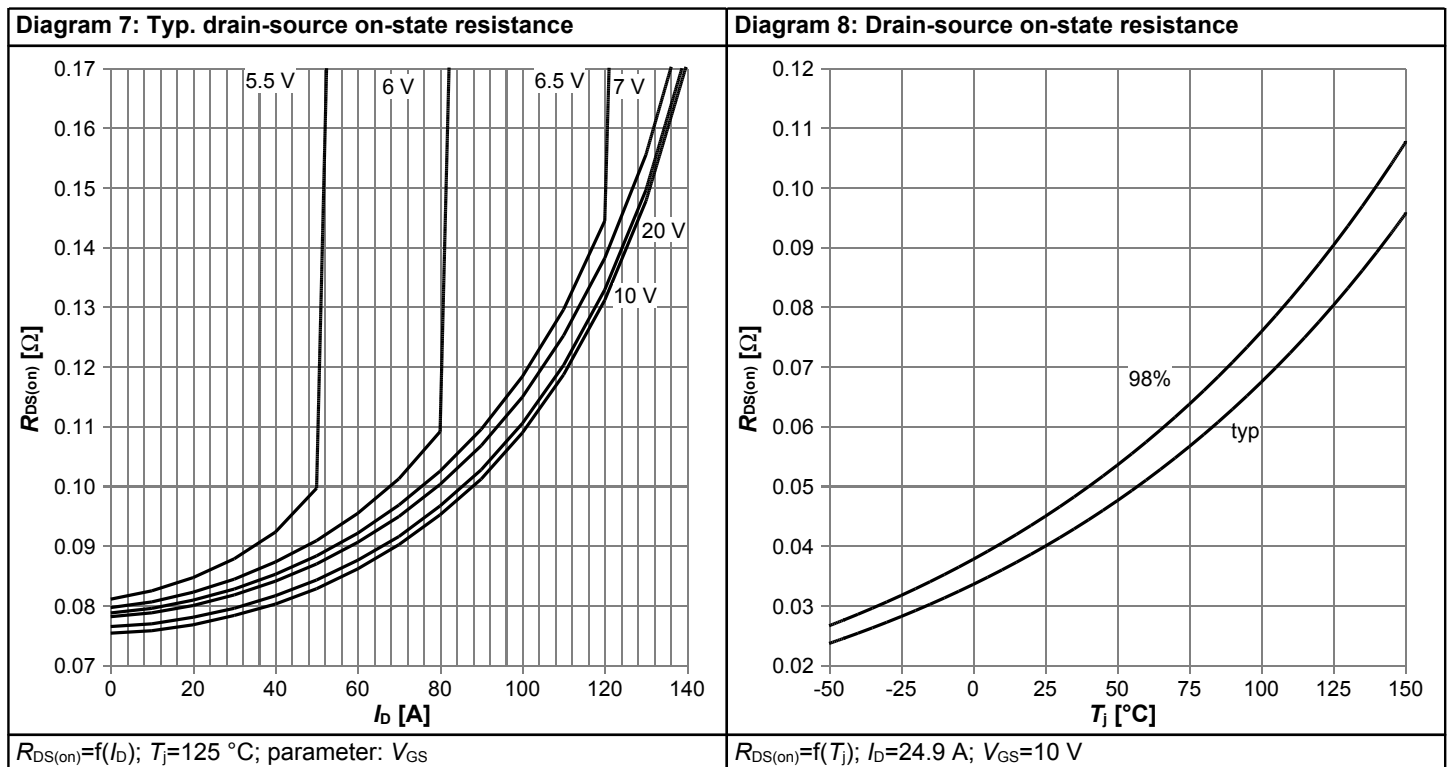

Table 12

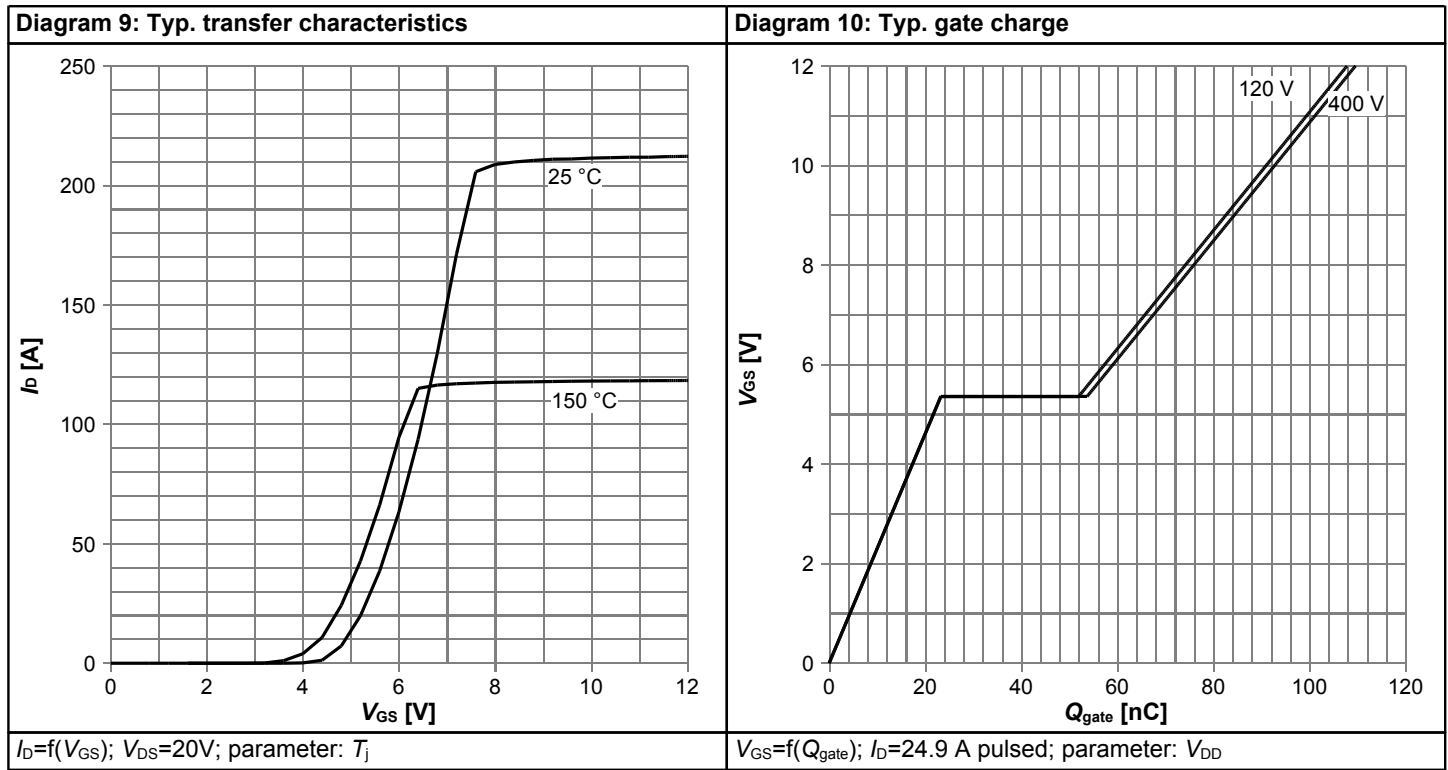

Table 13

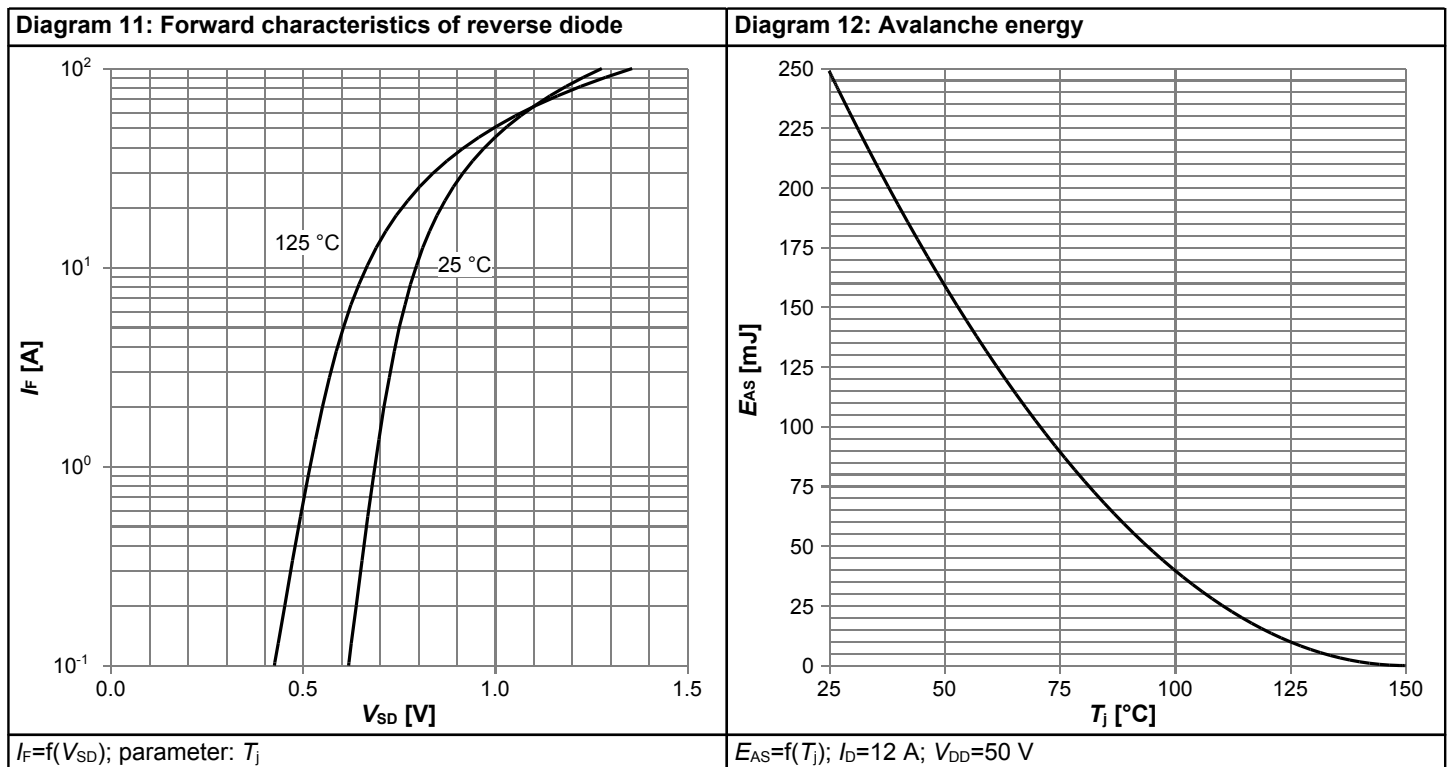

Table 14

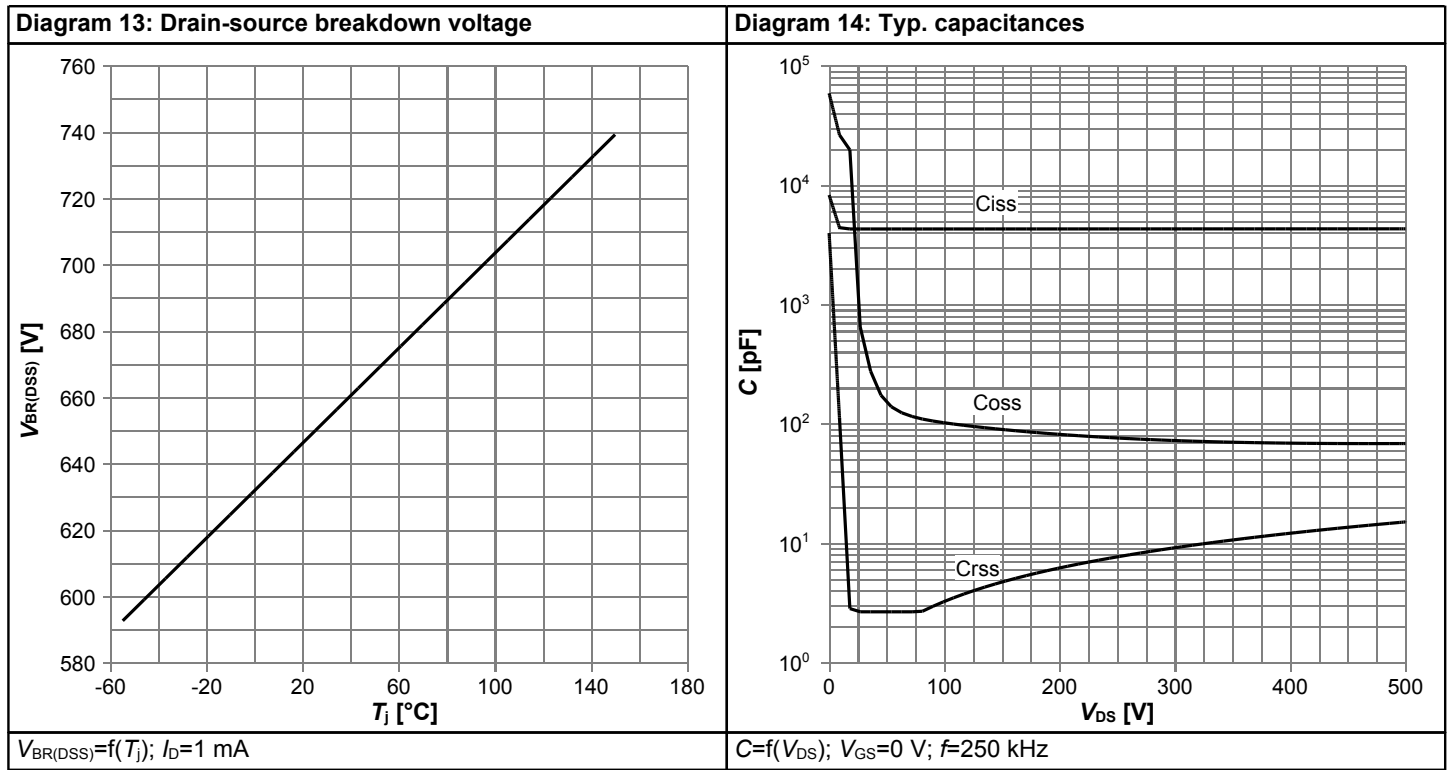
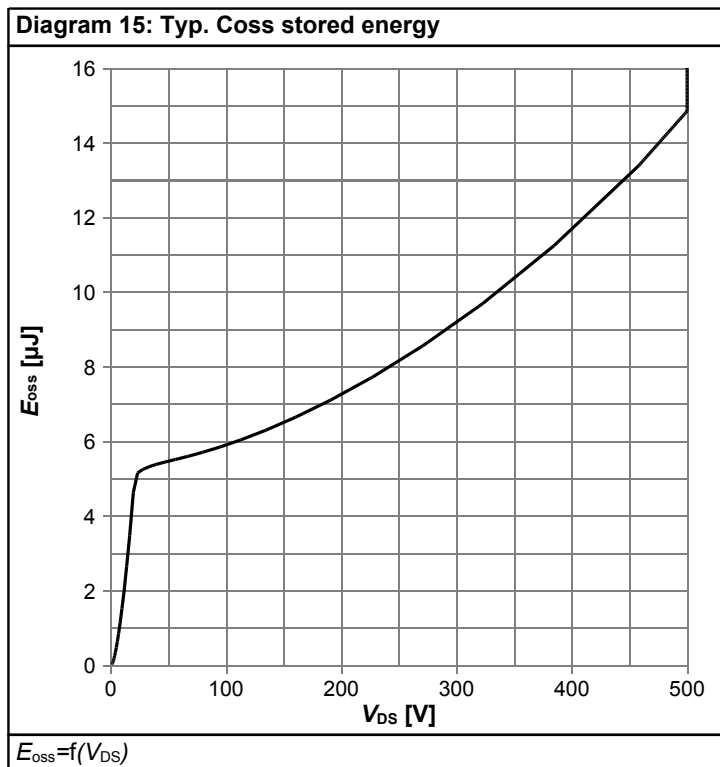

Table 15



6 Test Circuits

Table 16 Diode characteristics

| Test circuit for diode characteristics | Diode recovery waveform |
|--|-------------------------|
| | |

Table 17 Switching times

| Switching times test circuit for inductive load | Switching times waveform |
|---|--------------------------|
| | |

Table 18 Unclamped inductive load

| Unclamped inductive load test circuit | Unclamped inductive waveform |
|---------------------------------------|------------------------------|
| | |

7 Package Outlines

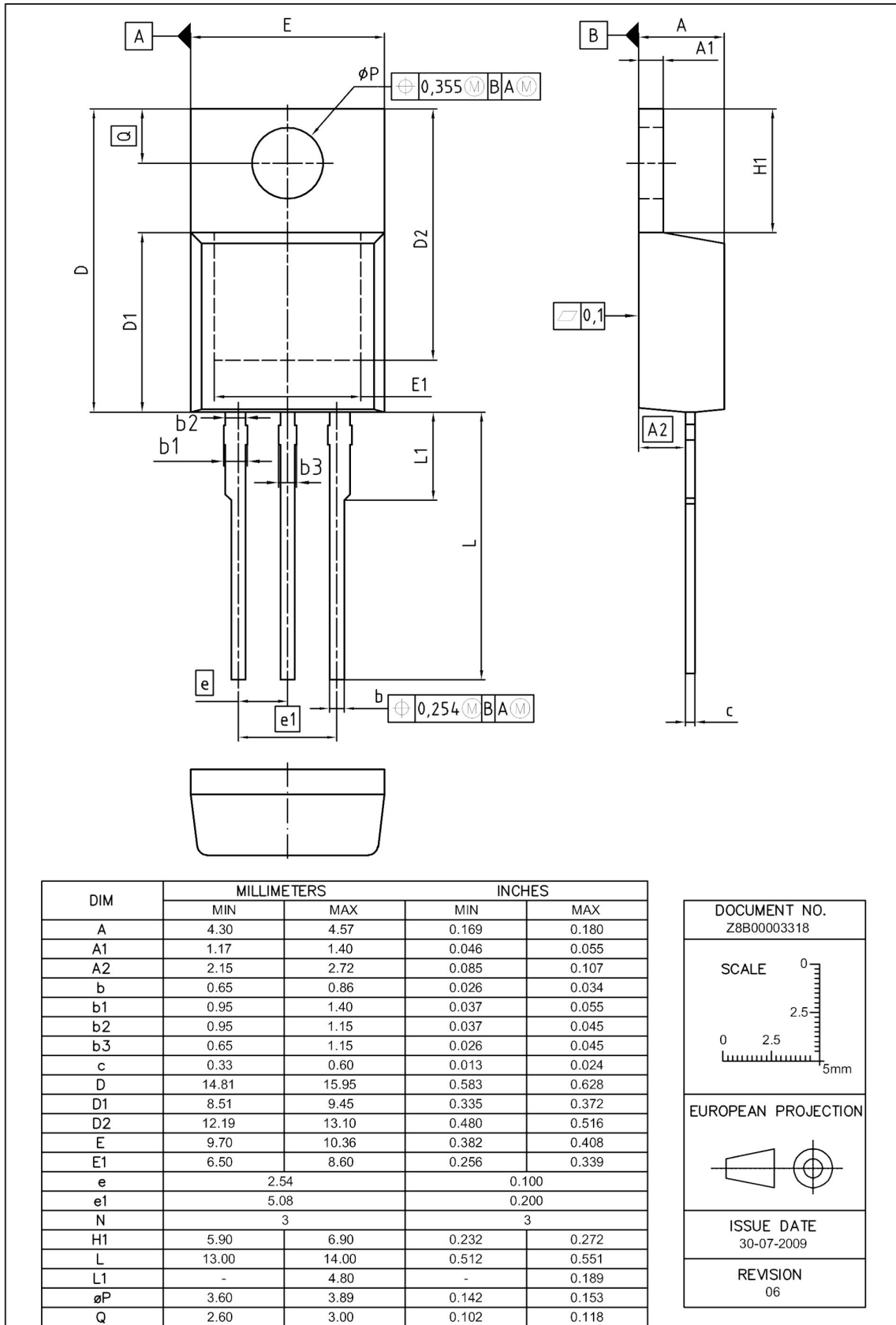

Figure 1 Outline PG-TO 220, dimensions in mm/inches

8 Appendix A

Table 19 Related Links

- IFX CoolMOS™ C7 Webpage: www.infineon.com
- IFX CoolMOS™ C7 application note: www.infineon.com
- IFX CoolMOS™ C7 simulation model: www.infineon.com
- IFX Design tools: www.infineon.com

Revision History

IPP65R045C7

Revision: 2013-04-30, Rev. 2.1

Previous Revision

| Revision | Date | Subjects (major changes since last revision) |
|----------|------------|--|
| 2.0 | 2013-04-18 | Release of final version |
| 2.1 | 2013-04-30 | Body diode di/dt update |

We Listen to Your Comments

Any information within this document that you feel is wrong, unclear or missing at all? Your feedback will help us to continuously improve the quality of this document. Please send your proposal (including a reference to this document) to:

erratum@infineon.com

Edition 2011-08-01**Published by****Infineon Technologies AG****81726 München, Germany****© 2011 Infineon Technologies AG****All Rights Reserved.**

Legal Disclaimer

The information given in this document shall in no event be regarded as a guarantee of conditions or characteristics. With respect to any examples or hints given herein, any typical values stated herein and/or any information regarding the application of the device, Infineon Technologies hereby disclaims any and all warranties and liabilities of any kind, including without limitation, warranties of non-infringement of intellectual property rights of any third party.

Information

For further information on technology, delivery terms and conditions and prices please contact your nearest Infineon Technologies Office (www.infineon.com).

Warnings

Due to technical requirements, components may contain dangerous substances. For information on the types in question, please contact the nearest Infineon Technologies Office.

The Infineon Technologies component described in this Data Sheet may be used in life-support devices or systems and/or automotive, aviation and aerospace applications or systems only with the express written approval of Infineon Technologies, if a failure of such components can reasonably be expected to cause the failure of that life-support, automotive, aviation and aerospace device or system or to affect the safety or effectiveness of that device or system. Life support devices or systems are intended to be implanted in the human body or to support and/or maintain and sustain and/or protect human life. If they fail, it is reasonable to assume that the health of the user or other persons may be endangered.

Данный компонент на территории Российской Федерации

Вы можете приобрести в компании MosChip.

Для оперативного оформления запроса Вам необходимо перейти по данной ссылке:

<http://moschip.ru/get-element>

Вы можете разместить у нас заказ для любого Вашего проекта, будь то серийное производство или разработка единичного прибора.

В нашем ассортименте представлены ведущие мировые производители активных и пассивных электронных компонентов.

Нашей специализацией является поставка электронной компонентной базы двойного назначения, продукции таких производителей как XILINX, Intel (ex.ALTERA), Vicor, Microchip, Texas Instruments, Analog Devices, Mini-Circuits, Amphenol, Glenair.

Сотрудничество с глобальными дистрибьюторами электронных компонентов, предоставляет возможность заказывать и получать с международных складов практически любой перечень компонентов в оптимальные для Вас сроки.

На всех этапах разработки и производства наши партнеры могут получить квалифицированную поддержку опытных инженеров.

Система менеджмента качества компании отвечает требованиям в соответствии с ГОСТ Р ИСО 9001, ГОСТ РВ 0015-002 и ЭС РД 009

Офис по работе с юридическими лицами:

105318, г.Москва, ул.Щербаковская д.3, офис 1107, 1118, ДЦ «Щербаковский»

Телефон: +7 495 668-12-70 (многоканальный)

Факс: +7 495 668-12-70 (доб.304)

E-mail: info@moschip.ru

Skype отдела продаж:

moschip.ru

moschip.ru_4

moschip.ru_6

moschip.ru_9