

Common Mode Filters

For power line

ACM series

Type:	ACM4520	[1808 inch]*
	ACM7060	[2824 inch]
	ACM9070	[3628 inch]
	ACM1211	[4844 inch]
	ACM1513	[6052 inch]

* Dimensions Code [EIA]

Issue date: March 2013

- All specifications are subject to change without notice.
- Conformity to RoHS Directive: This means that, in conformity with EU Directive 2002/95/EC, lead, cadmium, mercury, hexavalent chromium, and specific bromine-based flame retardants, PBB and PBDE, have not been used, except for exempted applications.

Common Mode Filters For Power Line

Conformity to RoHS Directive

ACM Series ACM4520

FEATURES

- Several large current products are prepared to correspond to the various applications.
- Low profile and compact shape, it is suited for surface mounting.
- It shows high common mode impedance despite of its compact shape.

APPLICATIONS

Radiation noise suppression for power line (DVC, DVD cam, DSC, etc.)

TEMPERATURE RANGES

Operating	-40 to +85°C
Storage(After mount)	-40 to +85°C

PACKAGING STYLE AND QUANTITIES

Packaging style	Reel	Quantity
Taping	ø180mm	800 pieces/reel
	ø330mm	2500 pieces/reel

PRODUCT IDENTIFICATION

ACM	4520	-	901	-	2P	-	T	-	□□□
(1)	(2)	(3)	(4)	(5)	(6)				

- (1) Series name
- (2) Dimensions W×T
4520: 4.5×2.0mm
- (3) Impedance [at 100MHz]
901: 900Ω
- (4) Numbers of lines
2P: 2-line
- (5) Packaging style
T: ø180mm reel taping
TL: ø330mm reel taping
- (6) TDK internal code

RECOMMENDED SOLDERING CONDITIONS

RECOMMENDED TEMPERATURE PROFILE FOR LEAD-FREE SOLDER

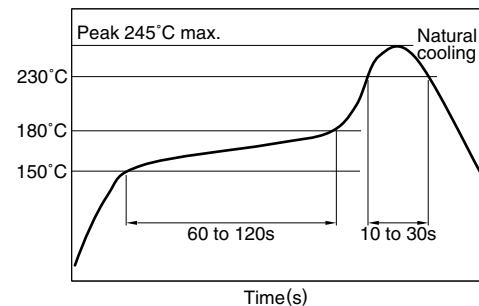

REFLOW PROFILE FOR SOLDER HEAT RESISTANCE

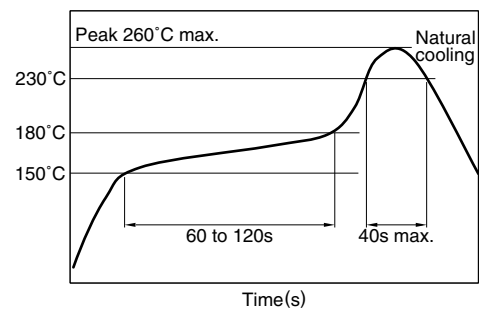

• Conformity to RoHS Directive: This means that, in conformity with EU Directive 2002/95/EC, lead, cadmium, mercury, hexavalent chromium, and specific bromine-based flame retardants, PBB and PBDE, have not been used, except for exempted applications.

• All specifications are subject to change without notice.

SHAPES AND DIMENSIONS

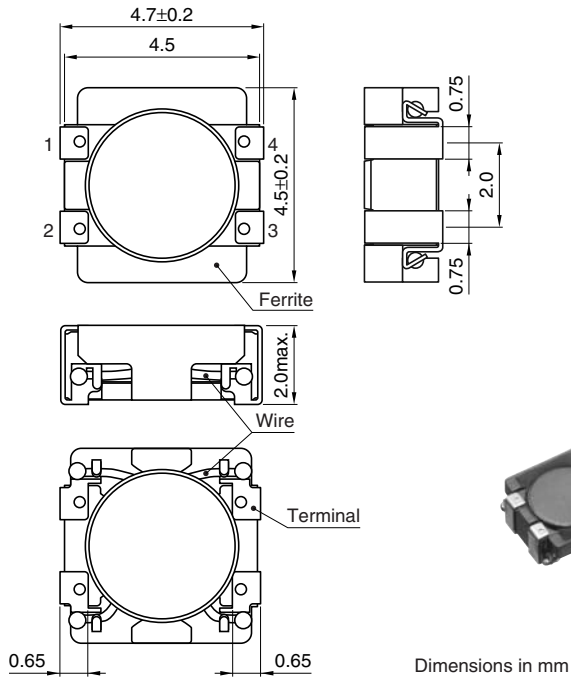

CIRCUIT DIAGRAM

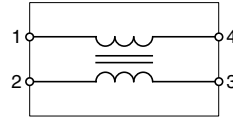

• No polarity

RECOMMENDED PC BOARD PATTERN

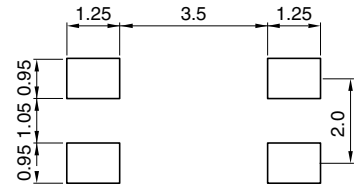

Dimensions in mm

ELECTRICAL CHARACTERISTICS

Part No.	Common mode impedance (Ω)[at 100MHz]		DC resistance (Ω)max. [1 line]	Rated current I_{dc} (A)max.		Rated voltage E_{dc} (V)max.	Insulation resistance (M Ω)min.
	min.	typ.		60°C	85°C		
ACM4520-231-2P	180	230	0.05	3.0	2.6	50	10
ACM4520-421-2P	300	420	0.055	2.8	2.4	50	10
ACM4520-901-2P	650	900	0.06	2.3	2.0	50	10
ACM4520-142-2P	1000	1400	0.08	1.7	1.5	50	10

TYPICAL ELECTRICAL CHARACTERISTICS
IMPEDANCE vs. FREQUENCY CHARACTERISTICS
ACM4520-231-2P

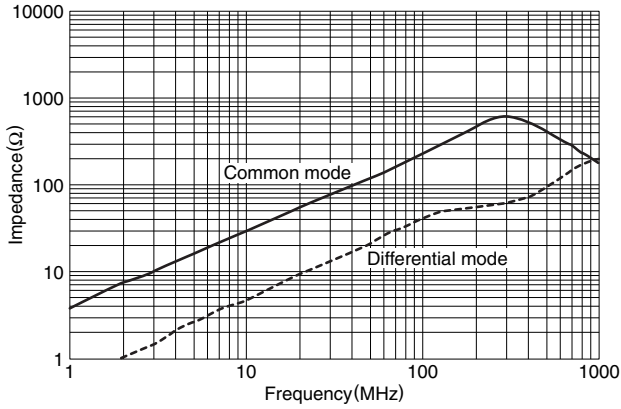

ACM4520-421-2P

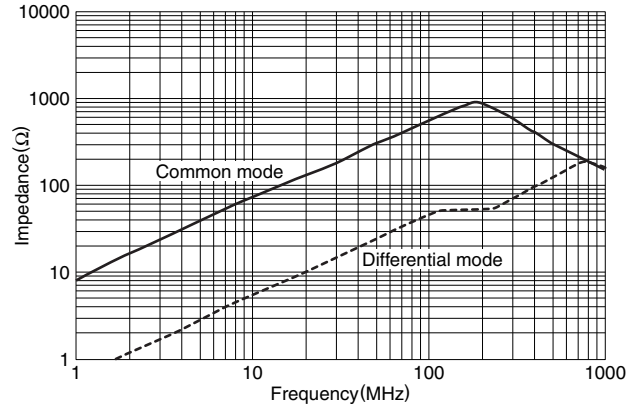

ACM4520-901-2P

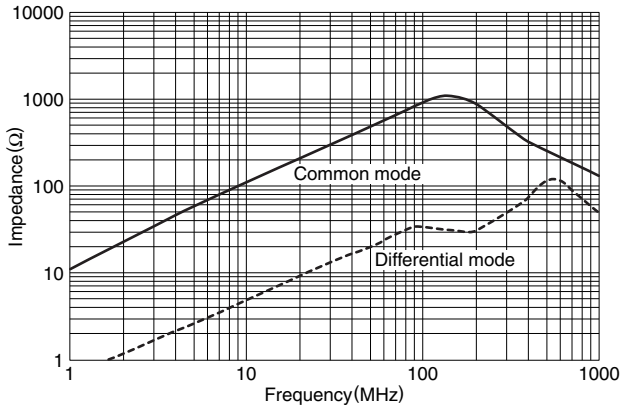

ACM4520-142-2P

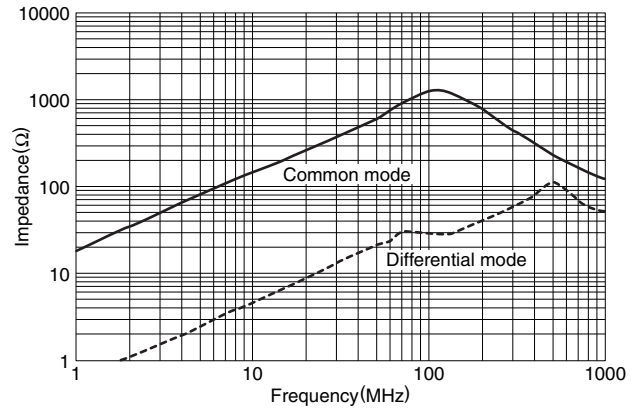

Common Mode Filters For Power Line

Conformity to RoHS Directive

ACM Series ACM7060, 9070, 1211, 1513

FEATURES

- A chip-type common mode filter for large current applications. Common mode impedance surpasses 300 to 1000Ω at 100MHz. Noise is greatly suppressed.
- Capable of handling the highest current (up to 10A) of any chip-type common mode filter.
- Height and size have been considered, resulting in a compact and light-weight choke coil. Applicable for the miniaturization required to reduce the size and weight of portable equipment.
- The products contain no lead and also support lead-free soldering.
- This product does not contain regulated substances that are slated to be included in RoHS.

APPLICATIONS

Used for power line noise suppression for any electronic devices
Used to counter adapter/battery line noise for relatively large electronic devices such as notebook PCs, stand-alone word processors, etc

TEMPERATURE RANGES

Operating	-40 to +85°C
Storage(After mount)	-40 to +85°C

PACKAGING STYLE AND QUANTITIES

Packaging style	Type	Reel	Quantity
Taping	ACM7060	ø330mm	1500 pieces/reel
	ACM9070	ø330mm	800 pieces/reel
	ACM1211	ø330mm	500 pieces/reel
	ACM1513	ø330mm	500 pieces/reel

PRODUCT IDENTIFICATION

ACM 7060 - 701 - 2PL - TL □□□
(1) (2) (3) (4) (5) (6)

- (1) Series
- (2) Dimensions L×W
7060: 7.0×6.0mm
- (3) Impedance[at 100MHz]
701: 700Ω
- (4) Number of lines
2PL: 2-line
- (5) Packaging style
T: ø180mm reel taping
TL: ø330mm reel taping
- (6) TDK internal code

RECOMMENDED SOLDERING CONDITIONS RECOMMENDED TEMPERATURE PROFILE FOR LEAD-FREE SOLDER

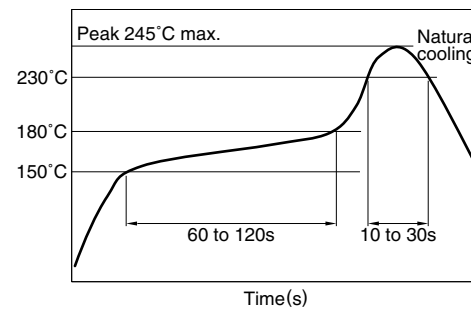

REFLOW PROFILE FOR SOLDER HEAT RESISTANCE

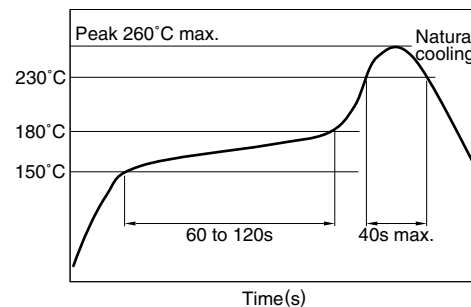

• Conformity to RoHS Directive: This means that, in conformity with EU Directive 2002/95/EC, lead, cadmium, mercury, hexavalent chromium, and specific bromine-based flame retardants, PBB and PBDE, have not been used, except for exempted applications.

• All specifications are subject to change without notice.

SHAPES AND DIMENSIONS/CIRCUIT DIAGRAM/RECOMMENDED PC BOARD PATTERN(REFLOW SOLDERING)

ACM7060 TYPE

ACM7060-301-2PL-TL01

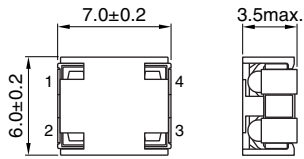

ACM7060-701-2PL-TL01

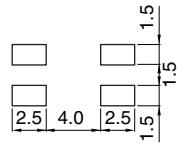
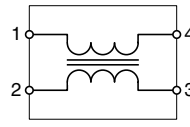
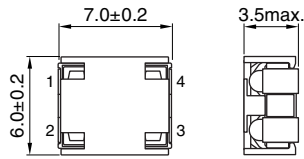

Dimensions in mm

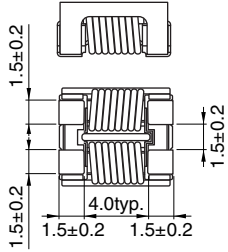
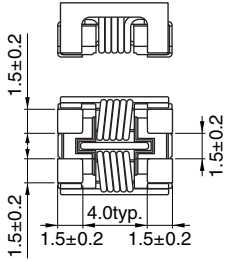

Weight: 0.35g
Dimensions in mm



ACM9070 TYPE

ACM9070-701-2PL-TL01

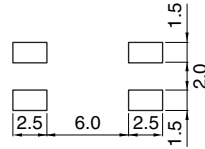
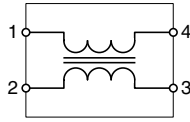
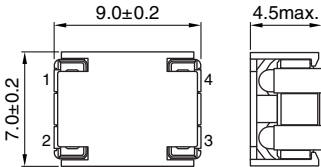

Dimensions in mm

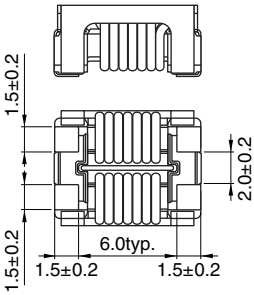

Weight: 0.82g
Dimensions in mm



SHAPES AND DIMENSIONS/CIRCUIT DIAGRAM/RECOMMENDED PC BOARD PATTERN(REFLOW SOLDERING)

ACM1211 TYPE

ACM1211-701-2PL-TL01

ACM1211-102-2PL-TL01

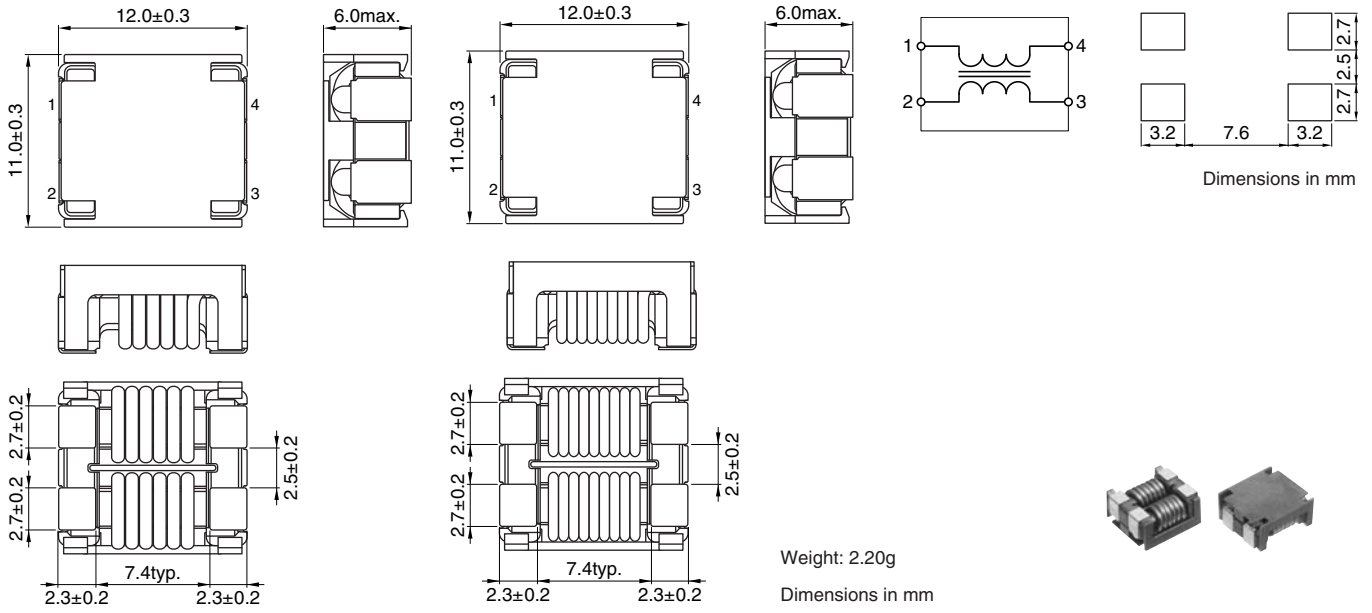

ACM1513 TYPE

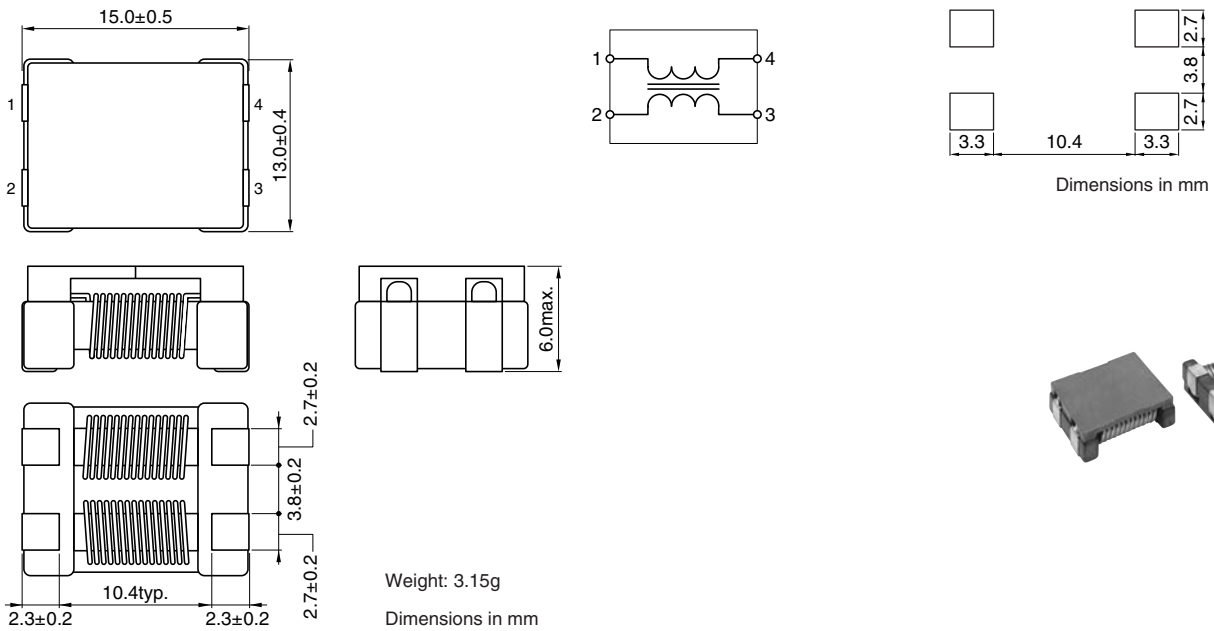

• All specifications are subject to change without notice.

ELECTRICAL CHARACTERISTICS

Part No.	Impedance (Ω) [at 100MHz]		DC resistance ($m\Omega$) max.	Rated current I_{dc} (A) max.	Insulation resistance ($M\Omega$) min.	Rated voltage E_{dc} (V) max.
	min.	typ.				
ACM7060-301-2PL-TL01	225	300	10	5	10	80
ACM7060-701-2PL-TL01	500	700	15	4	10	80
ACM9070-701-2PL-TL01	500	700	10	5	10	80
ACM1211-701-2PL-TL01	500	700	6	8	10	80
ACM1211-102-2PL-TL01	750	1000	14	6	10	80
ACM1513-551-2PL-TLHF	450	550	4	10	10	50

TYPICAL ELECTRICAL CHARACTERISTICS

IMPEDANCE vs. FREQUENCY CHARACTERISTICS

ACM7060-301-2PL-TL01

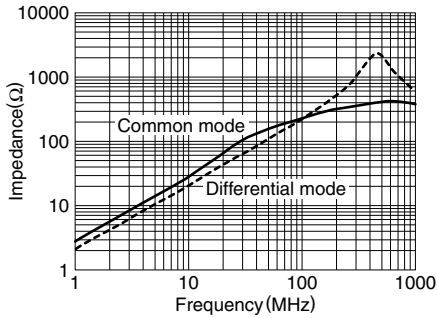

ACM7060-701-2PL-TL01

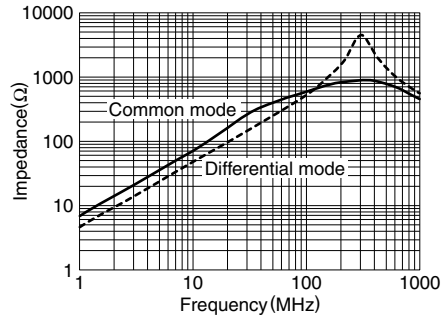

ACM9070-701-2PL-TL01

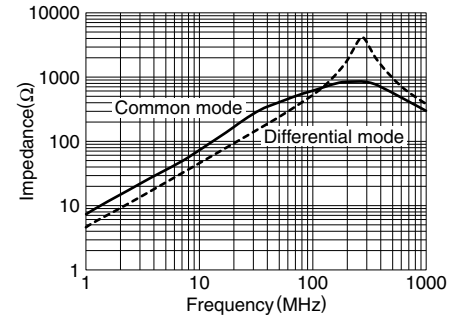

ACM1211-701-2PL-TL01

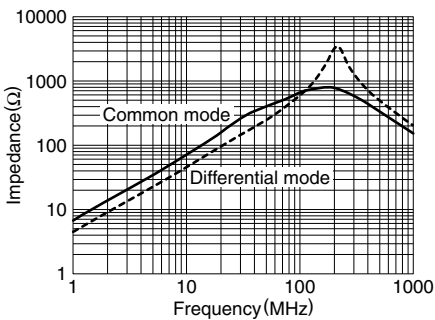

ACM1211-102-2PL-TL01

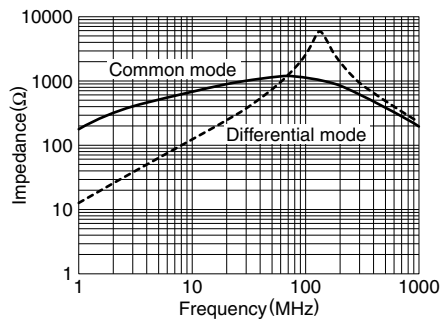

ACM1513-551-2PL-TLHF

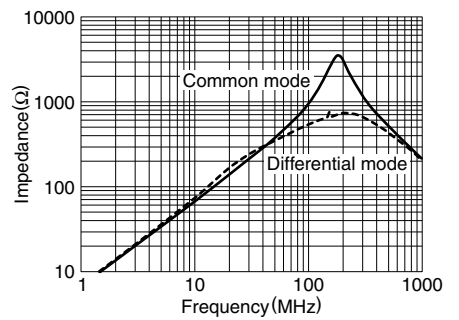

MEASURING CIRCUITS

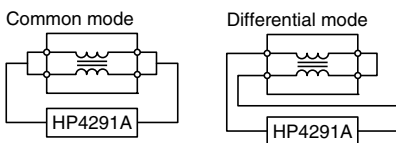

Данный компонент на территории Российской Федерации

Вы можете приобрести в компании MosChip.

Для оперативного оформления запроса Вам необходимо перейти по данной ссылке:

<http://moschip.ru/get-element>

Вы можете разместить у нас заказ для любого Вашего проекта, будь то серийное производство или разработка единичного прибора.

В нашем ассортименте представлены ведущие мировые производители активных и пассивных электронных компонентов.

Нашей специализацией является поставка электронной компонентной базы двойного назначения, продукции таких производителей как XILINX, Intel (ex.ALTERA), Vicor, Microchip, Texas Instruments, Analog Devices, Mini-Circuits, Amphenol, Glenair.

Сотрудничество с глобальными дистрибьюторами электронных компонентов, предоставляет возможность заказывать и получать с международных складов практически любой перечень компонентов в оптимальные для Вас сроки.

На всех этапах разработки и производства наши партнеры могут получить квалифицированную поддержку опытных инженеров.

Система менеджмента качества компании отвечает требованиям в соответствии с ГОСТ Р ИСО 9001, ГОСТ РВ 0015-002 и ЭС РД 009

Офис по работе с юридическими лицами:

105318, г.Москва, ул.Щербаковская д.3, офис 1107, 1118, ДЦ «Щербаковский»

Телефон: +7 495 668-12-70 (многоканальный)

Факс: +7 495 668-12-70 (доб.304)

E-mail: info@moschip.ru

Skype отдела продаж:

moschip.ru

moschip.ru_4

moschip.ru_6

moschip.ru_9