

Digital Panel Meter K3TG

CSM_K3TG_DS_E_2_1

Subminiature Digital Panel Meter that Accepts DC Input

- Ultra-compact DIN-size (48 x 24 (W x H)) body.
- Mounting thickness of only 2 mm required.
- Highly visible display with 10.2-mm-high LEDs.
- 5-VDC power supply for control.
- IP51 waterproofing with accessory attached.

 Refer to *Safety Precautions for All Digital Panel Meters*.

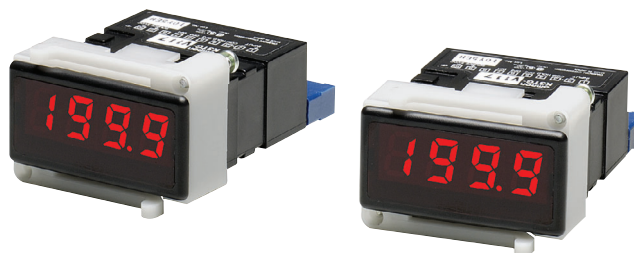

Model Number Structure

Model Number Legend

K3TG -
 1 2 3 4

1, 2. Input Code

- V1: ± 199.9 mV
- V2: ± 1.999 V
- V3: ± 19.99 V
- V4: ± 199.9 V

3. Series No.

- 1: Current series

4. Supply Voltage

- 7: 5 VDC (not internally insulated)

Ordering Information

List of Models

Range	Measuring ranges	Supply voltage
		5 VDC (not internally insulated)
DC voltage	± 199.9 mV	K3TG-V117
	± 1.999 V	K3TG-V217
	± 19.99 V	K3TG-V317
	± 199.9 V	K3TG-V417

Accessories (Order Separately)

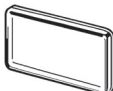
Name	Appearance	Model
Water-resistive Soft Front Cover		K32-L24SC

Specifications

■ Ratings

Supply voltage	5 VDC (not internally insulated)		
Operating voltage range	-5% to +5% of supply voltage		
Power consumption	0.3 W (at max. DC load)		
Insulation resistance	10 MΩ min. (at 500 VDC) between external terminal and case		
Dielectric strength	2,000 VAC min. for 1 min between external terminal and case		
Noise immunity	±200 V on power supply terminals in normal mode ±500 V on power supply terminals in common mode		
Vibration resistance	Malfunction: 10 to 55 Hz, 0.5-mm single amplitude for 10 min each in X, Y, and Z directions Destruction: 10 to 55 Hz, 0.75-mm single amplitude for 2 hrs each in X, Y, and Z directions		
Shock resistance	Malfunction: 98 m/s ² for 3 times each in 6 directions Destruction: 294 m/s ² for 3 times each in 6 directions		
Ambient temperature	Operating: -10° to 55°C (with no icing) Storage: -20° to 65°C (with no icing)		
Ambient humidity	Operating: 35% to 85% (with no condensation)		
Ambient operating atmosphere	No corrosive gas		
EMC	(EMI)	EN61326+A1	Industry
	Emission Enclosure:	CISPR 11 Group 1 class A: CISRP16-1/-2	
	Emission AC Mains:	CISPR 11 Group 1 class A: CISRP16-1/-2	
	(EMS)	EN61326+A1	Industry
	Immunity ESD:	EN61000-4-2:	4 kV contact discharge (level 2) 8 kV air discharge (level 3)
	Immunity RF-interference:	EN61000-4-3:	10 V/m (amplitude-modulated, 80 MHz to 1 GHz) (level 3)
	Immunity Fast Transient Noise:	EN61000-4-4:	2 kV (power line) (level 3)
	Immunity Burst Noise:		1 kV line to line (I/O signal line)
	Immunity Surge:	EN61000-4-5:	1 kV line to line 2 kV line to ground (power line)
	Immunity Conducted Disturbance	EN61000-4-6:	3 V (0.15 to 80 MHz) (level 2)
	Immunity Voltage Dip/Interrupting	EN61000-4-11:	0.5 cycles, 0, 180°, 100% (rated voltage)

■ Characteristics

Input signal	DC voltage
A/D conversion method	Double integral method
Sampling period	2.5 times/s
Display refresh period	2.5 times/s
Max. displayed digits	3 1/2 digits (+1999)
Display	7-segment red LED
Decimal point display position	By short-circuiting terminals
Sign display	"-" is displayed automatically with a negative input signal.
Overflow/underflow display	Overflow: #□□□ Underflow: - #□□□
Zero suppression	Not supported.
External control	Process value hold (terminals on rear panel short-circuited)
Degree of protection	Front panel: IEC IP51 (see note) Case: IEC IP20 Terminals: IEC IP00

Note: IP51 is maintained when the water-resistant soft cover and bracket are used. IP50 will be, however, maintained without these water-resistant accessories.

■ Measuring Ranges

Input range	Measuring range	Max. resolution	Input impedance	Accuracy	Max. permissible load
DC voltage	±199.9 mV	100 μV	100 MΩ	±0.1%rdg ±1 digit	±250 V
	±1.999 V	1 mV	100 MΩ	±0.1%rdg ±1 digit	±250 V
	±19.99 V	10 mV	10 MΩ	±0.1%rdg ±1 digit	±250 V
	±199.9 V	100 mV	10 MΩ	±0.1%rdg ±1 digit	±350 V

Note: The above accuracy is at an ambient temperature of 23±5°C.

Connections

External Connections

External Connection (Connector and connector screws are provided with the model.)

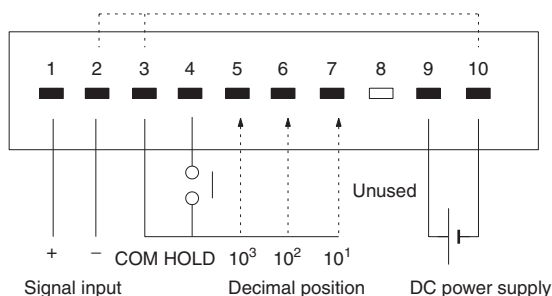

Conformance to EN/IEC Standards

To ensure conformance to EN/IEC standards in machinery that incorporates the K3TG, ensure that input signal lines are less than 30 m.

- Note:** 1. Terminals 2 and 3 and 10 are not internally insulated. Connect a relay with high contact reliability and insulation (with a minimum load current of 0.3 mA) or a photocoupler with high insulation (with a residual voltage of 1 V max. and a current leakage of 0.1 mA max.) to these terminals for external control. The use of an independent power supply is recommended for the Digital Panel Meter.
 2. Terminal 8 is not used. Do not use this terminal for transmission of signals.

Nomenclature



PV display

Select the decimal position with terminal 5, 6, or 7 on the rear panel.



Dimensions

Note: All units are in millimeters unless otherwise indicated.

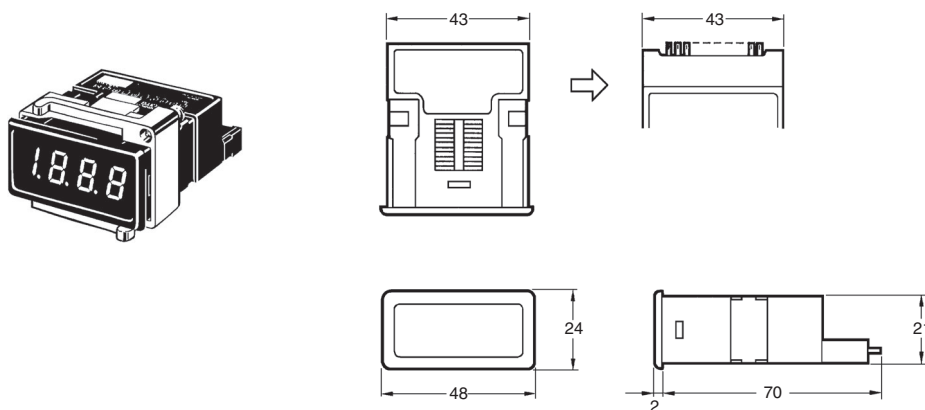

Panel Cutouts

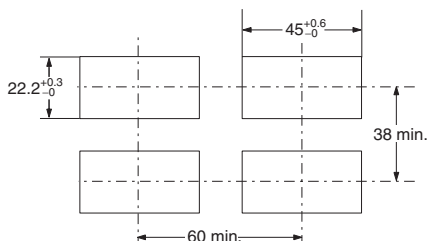

LED Indicator Size

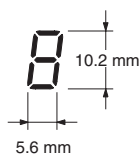

Note: The values above are recommended values. Do not group-mount the meters at intervals less than the recommended ones.

Application Examples

High DC Voltage Measurement

When voltage exceeding the maximum voltage in the standard range is measured (for example: more than 200 V), a divider is connected externally.

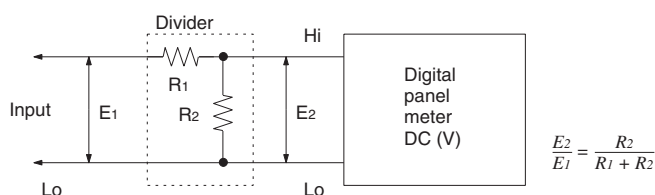

Safety Precautions

■ Precautions for Correct Use

Refer to *Safety Precautions for All Digital Panel Meters*.

Mounting

Recommended panel thickness is 1 to 3.2 mm.

Mount the Digital Panel Meter by attaching the mounting bracket supplied as an accessory from the rear of the Digital Panel Meter and hooking the mounting bracket to the Digital Panel Meter securely.

Tighten the mounting screws by turning them clockwise with a tightening torque of 4 kgf·cm (0.39 N·m).

To dismount the Digital Panel Meter, loosen the screws and widen the hooks.

Mount the Digital Panel Meter as horizontally as possible.

Calibration

Calibrate the Digital Panel Meter regularly so that the Digital Panel Meter can maintain processing accuracy.

Use a standard signal generator with an accuracy of 99.99% min. for calibration.

For the precise calibration methods, refer to the Instruction Sheet for the Digital Panel Meter.

Control Power Supply

Use a control power supply with a ripple rate of 10% max.

Accessories (Order Separately)

Water-resistant Soft Front Cover

Before mounting the Digital Panel Meter to a panel, attach the water-resistant soft front cover and mounting bracket to the Digital Panel Meter properly so that the Digital Panel Meter will maintain IP51 water-resistant standards.

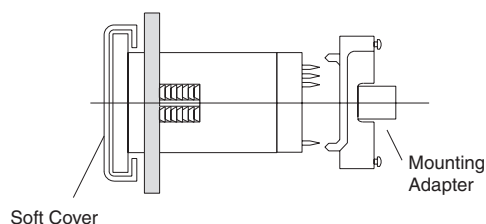

Note: Be sure to use the Water-resistant Soft Front Cover and mounting bracket together.

ALL DIMENSIONS SHOWN ARE IN MILLIMETERS.

To convert millimeters into inches, multiply by 0.03937. To convert grams into ounces, multiply by 0.03527.

In the interest of product improvement, specifications are subject to change without notice.

Read and Understand This Catalog

Please read and understand this catalog before purchasing the products. Please consult your OMRON representative if you have any questions or comments.

Warranty and Limitations of Liability

WARRANTY

OMRON's exclusive warranty is that the products are free from defects in materials and workmanship for a period of one year (or other period if specified) from date of sale by OMRON.

OMRON MAKES NO WARRANTY OR REPRESENTATION, EXPRESS OR IMPLIED, REGARDING NON-INFRINGEMENT, MERCHANTABILITY, OR FITNESS FOR PARTICULAR PURPOSE OF THE PRODUCTS. ANY BUYER OR USER ACKNOWLEDGES THAT THE BUYER OR USER ALONE HAS DETERMINED THAT THE PRODUCTS WILL SUITABLY MEET THE REQUIREMENTS OF THEIR INTENDED USE. OMRON DISCLAIMS ALL OTHER WARRANTIES, EXPRESS OR IMPLIED.

LIMITATIONS OF LIABILITY

OMRON SHALL NOT BE RESPONSIBLE FOR SPECIAL, INDIRECT, OR CONSEQUENTIAL DAMAGES, LOSS OF PROFITS OR COMMERCIAL LOSS IN ANY WAY CONNECTED WITH THE PRODUCTS, WHETHER SUCH CLAIM IS BASED ON CONTRACT, WARRANTY, NEGLIGENCE, OR STRICT LIABILITY.

In no event shall the responsibility of OMRON for any act exceed the individual price of the product on which liability is asserted.

IN NO EVENT SHALL OMRON BE RESPONSIBLE FOR WARRANTY, REPAIR, OR OTHER CLAIMS REGARDING THE PRODUCTS UNLESS OMRON'S ANALYSIS CONFIRMS THAT THE PRODUCTS WERE PROPERLY HANDLED, STORED, INSTALLED, AND MAINTAINED AND NOT SUBJECT TO CONTAMINATION, ABUSE, MISUSE, OR INAPPROPRIATE MODIFICATION OR REPAIR.

Application Considerations

SUITABILITY FOR USE

OMRON shall not be responsible for conformity with any standards, codes, or regulations that apply to the combination of products in the customer's application or use of the products.

At the customer's request, OMRON will provide applicable third party certification documents identifying ratings and limitations of use that apply to the products. This information by itself is not sufficient for a complete determination of the suitability of the products in combination with the end product, machine, system, or other application or use.

The following are some examples of applications for which particular attention must be given. This is not intended to be an exhaustive list of all possible uses of the products, nor is it intended to imply that the uses listed may be suitable for the products:

- Outdoor use, uses involving potential chemical contamination or electrical interference, or conditions or uses not described in this catalog.
- Nuclear energy control systems, combustion systems, railroad systems, aviation systems, medical equipment, amusement machines, vehicles, safety equipment, and installations subject to separate industry or government regulations.
- Systems, machines, and equipment that could present a risk to life or property.

Please know and observe all prohibitions of use applicable to the products.

NEVER USE THE PRODUCTS FOR AN APPLICATION INVOLVING SERIOUS RISK TO LIFE OR PROPERTY WITHOUT ENSURING THAT THE SYSTEM AS A WHOLE HAS BEEN DESIGNED TO ADDRESS THE RISKS, AND THAT THE OMRON PRODUCTS ARE PROPERLY RATED AND INSTALLED FOR THE INTENDED USE WITHIN THE OVERALL EQUIPMENT OR SYSTEM.

PROGRAMMABLE PRODUCTS

OMRON shall not be responsible for the user's programming of a programmable product, or any consequence thereof.

Disclaimers

CHANGE IN SPECIFICATIONS

Product specifications and accessories may be changed at any time based on improvements and other reasons.

It is our practice to change model numbers when published ratings or features are changed, or when significant construction changes are made. However, some specifications of the products may be changed without any notice. When in doubt, special model numbers may be assigned to fix or establish key specifications for your application on your request. Please consult with your OMRON representative at any time to confirm actual specifications of purchased products.

DIMENSIONS AND WEIGHTS

Dimensions and weights are nominal and are not to be used for manufacturing purposes, even when tolerances are shown.

PERFORMANCE DATA

Performance data given in this catalog is provided as a guide for the user in determining suitability and does not constitute a warranty. It may represent the result of OMRON's test conditions, and the users must correlate it to actual application requirements. Actual performance is subject to the OMRON Warranty and Limitations of Liability.

ERRORS AND OMISSIONS

The information in this document has been carefully checked and is believed to be accurate; however, no responsibility is assumed for clerical, typographical, or proofreading errors, or omissions.

2008.11

In the interest of product improvement, specifications are subject to change without notice.

OMRON Corporation
Industrial Automation Company

<http://www.ia.omron.com/>

(c)Copyright OMRON Corporation 2008 All Right Reserved.

Mouser Electronics

Authorized Distributor

Click to View Pricing, Inventory, Delivery & Lifecycle Information:

Omron:

[K3TG-V317](#) [CONNECTOR FOR K3TG](#) [K3TG-V217](#) [K32-L24SC](#)

Данный компонент на территории Российской Федерации

Вы можете приобрести в компании MosChip.

Для оперативного оформления запроса Вам необходимо перейти по данной ссылке:

<http://moschip.ru/get-element>

Вы можете разместить у нас заказ для любого Вашего проекта, будь то серийное производство или разработка единичного прибора.

В нашем ассортименте представлены ведущие мировые производители активных и пассивных электронных компонентов.

Нашей специализацией является поставка электронной компонентной базы двойного назначения, продукции таких производителей как XILINX, Intel (ex.ALTERA), Vicor, Microchip, Texas Instruments, Analog Devices, Mini-Circuits, Amphenol, Glenair.

Сотрудничество с глобальными дистрибьюторами электронных компонентов, предоставляет возможность заказывать и получать с международных складов практически любой перечень компонентов в оптимальные для Вас сроки.

На всех этапах разработки и производства наши партнеры могут получить квалифицированную поддержку опытных инженеров.

Система менеджмента качества компании отвечает требованиям в соответствии с ГОСТ Р ИСО 9001, ГОСТ РВ 0015-002 и ЭС РД 009

Офис по работе с юридическими лицами:

105318, г.Москва, ул.Щербаковская д.3, офис 1107, 1118, ДЦ «Щербаковский»

Телефон: +7 495 668-12-70 (многоканальный)

Факс: +7 495 668-12-70 (доб.304)

E-mail: info@moschip.ru

Skype отдела продаж:

moschip.ru

moschip.ru_4

moschip.ru_6

moschip.ru_9