

## FEATURES

- Two channels in small 4 mm × 4 mm LFCSP
- Gain set with 1 resistor per amplifier ( $G = 1$  to 10,000)
- Low noise
  - 8 nV/ $\sqrt{\text{Hz}}$  at 1 kHz
  - 0.25  $\mu\text{V}$  p-p (0.1 Hz to 10 Hz)
- High accuracy dc performance (B grade)
  - 60  $\mu\text{V}$  maximum input offset voltage
  - 0.3  $\mu\text{V}/^\circ\text{C}$  maximum input offset drift
  - 1.0 nA maximum input bias current
  - 126 dB minimum CMRR ( $G = 100$ )
- Excellent ac performance
  - 140 kHz bandwidth ( $G = 100$ )
  - 13  $\mu\text{s}$  settling time to 0.001%
- Differential output option (single channel)
  - Fully specified
  - Adjustable common-mode output
- Supply range:  $\pm 2.3$  V to  $\pm 18$  V

## APPLICATIONS

- Multichannel data acquisition for
  - ECG and medical instrumentation
  - Industrial process controls
  - Wheatstone bridge sensors
- Differential drives for
  - High resolution input ADCs
  - Remote sensors

## GENERAL DESCRIPTION

The [AD8222](#) is a dual-channel, high performance instrumentation amplifier that requires only one external resistor per amplifier to set gains of 1 to 10,000.

The [AD8222](#) is the first dual-instrumentation amplifier in the small 4 mm × 4mm LFCSP. It requires the same board area as a typical single instrumentation amplifier. The smaller package allows a 2× increase in channel density and a lower cost per channel, all with no compromise in performance.

The [AD8222](#) can also be configured as a single-channel, differential output instrumentation amplifier. Differential outputs provide high noise immunity, which can be useful when the output signal must travel through a noisy environment, such as with remote sensors. The configuration can also be used to drive differential input analog-to-digital converters (ADCs). The

## FUNCTIONAL BLOCK DIAGRAM



Figure 1.

[AD8222](#) maintains a minimum CMRR of 80 dB to 4 kHz for all grades at  $G = 1$ . High CMRR over frequency allows the [AD8222](#) to reject wideband interference and line harmonics, greatly simplifying filter requirements. The [AD8222](#) also has a typical CMRR drift over temperature of just 0.07  $\mu\text{V}/\text{V}/^\circ\text{C}$  at  $G = 1$ .

The [AD8222](#) operates on both single and dual supplies and only requires 2.2 mA maximum supply current for both amplifiers. It is specified over the industrial temperature range of  $-40^\circ\text{C}$  to  $+85^\circ\text{C}$  and is fully RoHS compliant.

For a single-channel version, see the [AD8221](#).

**Table 1. Instrumentation Amplifiers by Category<sup>1</sup>**

General-Purpose	Zero Drift	Military Grade	Low Power	High Speed PGA
<a href="#">AD8220</a>	<a href="#">AD8231</a>	<a href="#">AD620</a>	<a href="#">AD8235</a>	<a href="#">AD8250</a>
<a href="#">AD8221</a>	<a href="#">AD8290</a>	<a href="#">AD621</a>	<a href="#">AD8236</a>	<a href="#">AD8251</a>
<a href="#">AD8222</a>	<a href="#">AD8293G80</a>	<a href="#">AD524</a>	<a href="#">AD627</a>	<a href="#">AD8253</a>
<a href="#">AD8224</a>	<a href="#">AD8553</a>	<a href="#">AD526</a>	<a href="#">AD623</a>	
<a href="#">AD8228</a>	<a href="#">AD8556</a>	<a href="#">AD624</a>	<a href="#">AD8223</a>	
<a href="#">AD8295</a>	<a href="#">AD8557</a>		<a href="#">AD8226</a>	
			<a href="#">AD8227</a>	

<sup>1</sup> See [www.analog.com](http://www.analog.com) for the latest selection of instrumentation amplifiers.

## TABLE OF CONTENTS

Features .....	1	Package Considerations.....	16
Applications.....	1	Layout .....	16
Functional Block Diagram .....	1	Input Bias Current Return Path .....	17
General Description .....	1	Input Protection .....	18
Revision History .....	2	RF Interference .....	18
Specifications.....	3	Common-Mode Input Voltage Range .....	18
Absolute Maximum Ratings.....	6	Applications Information .....	19
Thermal Resistance .....	6	Differential Output .....	19
ESD Caution.....	6	Driving a Differential Input ADC.....	20
Pin Configuration and Function Descriptions.....	7	Precision Strain Gage.....	20
Typical Performance Characteristics .....	8	Driving Cabling.....	21
Theory of Operation .....	15	Outline Dimensions .....	22
Amplifier Architecture .....	15	Ordering Guide .....	23
Gain Selection .....	15		
Reference Terminal .....	16		

## REVISION HISTORY

### 5/2016—Rev. A to Rev. B

Changed CP-16-13 to CP-16-26 .....	Throughout
Change to Table 5 .....	6
Changes to Figure 2 and Table 7 .....	7
Added Figure 3; Renumbered Sequentially .....	7
Change to Input Protection Section.....	18
Updated Outline Dimensions .....	22
Changes to Ordering Guide .....	23

### 2/2010—Rev. 0 to Rev. A

Added LFCSP_VQ, CP-16-13 Package .....	Universal
Changes to Features Section and Table 1 .....	1
Changed $V_{IN+}$ to $V_{+IN}$ , $V_{IN-}$ to $V_{-IN}$ , and T to $T_A$ Throughout.....	3
Change to Reference Input Parameter, Table 2.....	4
Changed Output Short-Circuit Current to Output Short-Circuit Duration, Table 5 .....	6

Changes to Thermal Resistance Section and Table 6 .....	6
Changes to Figure 2.....	7
Changes to Figure 19.....	10
Changes to Figure 43.....	14
Changes to Reference Terminal Section, Figure 45, and Package Considerations Section .....	16
Deleted Thermal Pad Section .....	16
Added Package Without Thermal Pad and Package with Thermal Pad Sections .....	16
Changes to Figure 46.....	17
Deleted Solder Wash Section .....	17
Changes to RFI and Antialiasing Filter Section .....	20
Updated Outline Dimensions .....	22
Changes to Ordering Guide .....	23

### 7/2006—Revision 0: Initial Version

## SPECIFICATIONS

$V_S = \pm 15\text{ V}$ ,  $V_{REF} = 0\text{ V}$ ,  $T_A = 25^\circ\text{C}$ ,  $G = 1$ ,  $R_L = 2\text{ k}\Omega$ , unless otherwise noted.

Table 2. Single-Ended and Differential<sup>1</sup> Output Configuration

Parameter	Test Conditions/Comments	A Grade			B Grade			Unit
		Min	Typ	Max	Min	Typ	Max	
COMMON-MODE REJECTION RATIO (CMRR)	$V_{CM} = -10\text{ V to } +10\text{ V}$							
CMRR DC to 60 Hz	1 k $\Omega$ source imbalance							
G = 1		80			86			dB
G = 10		100			106			dB
G = 100		120			126			dB
G = 1000		130			140			dB
CMRR at 4 kHz								
G = 1		80			80			dB
G = 10		90			100			dB
G = 100		100			110			dB
G = 1000		100			110			dB
CMRR Drift	$T_A = -40^\circ\text{C to } +85^\circ\text{C}$ , $G = 1$		0.07			0.07		$\mu\text{V/V}/^\circ\text{C}$
NOISE								
Voltage Noise, 1 kHz	RTI noise = $\sqrt{(e_{NI}^2 + (e_{NO}/G)^2)}$							
Input Voltage Noise, $e_{NI}$	$V_{+IN}, V_{-IN}, V_{REF} = 0\text{ V}$			8		8		nV/ $\sqrt{\text{Hz}}$
Output Voltage Noise, $e_{NO}$	$V_{+IN}, V_{-IN}, V_{REF} = 0\text{ V}$			75		75		nV/ $\sqrt{\text{Hz}}$
RTI	$f = 0.1\text{ Hz to } 10\text{ Hz}$							
G = 1			2			2		$\mu\text{V p-p}$
G = 10			0.5			0.5		$\mu\text{V p-p}$
G = 100 to 1000			0.25			0.25		$\mu\text{V p-p}$
Current Noise	$f = 1\text{ kHz}$		40			40		fA/ $\sqrt{\text{Hz}}$
	$f = 0.1\text{ Hz to } 10\text{ Hz}$		6			6		pA p-p
VOLTAGE OFFSET	RTI $V_{OS} = (V_{OSI}) + (V_{OSO}/G)$							
Input Offset, $V_{OSI}$	$V_S = \pm 5\text{ V to } \pm 15\text{ V}$			120		60		$\mu\text{V}$
Over Temperature	$T_A = -40^\circ\text{C to } +85^\circ\text{C}$			150		80		$\mu\text{V}$
Average TC				0.4		0.3		$\mu\text{V}/^\circ\text{C}$
Output Offset, $V_{OSO}$	$V_S = \pm 5\text{ V to } \pm 15\text{ V}$			500		350		$\mu\text{V}$
Over Temperature	$T_A = -40^\circ\text{C to } +85^\circ\text{C}$			0.8		0.5		mV
Average TC				9		5		$\mu\text{V}/^\circ\text{C}$
Offset RTI vs. Supply (PSR)	$V_S = \pm 2.3\text{ V to } \pm 18\text{ V}$							
G = 1		90	110		94	110		dB
G = 10		110	120		114	130		dB
G = 100		124	130		130	140		dB
G = 1000		130	140		140	150		dB
INPUT CURRENT (PER CHANNEL)								
Input Bias Current, $I_{BIAS}$			0.5	2.0		0.2	1.0	nA
Over Temperature	$T_A = -40^\circ\text{C to } +85^\circ\text{C}$			3.0			1.5	nA
Average TC			1			1		pA/ $^\circ\text{C}$
Input Offset Current, $I_{OFFSET}$			0.2	1		0.1	0.5	nA
Over Temperature	$T_A = -40^\circ\text{C to } +85^\circ\text{C}$			1.5			0.6	nA
Average TC			1			0.5	2	pA/ $^\circ\text{C}$

Parameter	Test Conditions/Comments	A Grade			B Grade			Unit	
		Min	Typ	Max	Min	Typ	Max		
REFERENCE INPUT									
$R_{IN}$	$V_{+IN}, V_{-IN}, V_{REF} = 0\text{ V}$		20			20		k $\Omega$	
$I_{IN}$			50	60		50	60	$\mu\text{A}$	
Voltage Range			$-V_S$		$+V_S$	$-V_S$		$+V_S$	V
Reference Gain to Output				1			1		V/V
Reference Gain Error				0.01			0.01		%
GAIN	$G = 1 + (49.4\text{ k}\Omega/R_G)$								
Gain Range	$V_{OUT} \pm 10\text{ V}$	1		10,000	1		10,000	V/V	
Gain Error									
$G = 1$				0.05			0.02	%	
$G = 10$				0.3			0.15	%	
$G = 100$				0.3			0.15	%	
$G = 1000$			0.3			0.15	%		
Gain Nonlinearity	$V_{OUT} = -10\text{ V to }+10\text{ V}$								
$G = 1$			3	10		1	5	ppm	
$G = 10$				7	20		7	20	ppm
$G = 100$				7	20		7	20	ppm
Gain vs. Temperature									
$G = 1$			3	10		2	5	ppm/ $^{\circ}\text{C}$	
$G > 1^2$				-50			-50	ppm/ $^{\circ}\text{C}$	
INPUT									
Input Impedance									
Differential				100  2			100  2	G $\Omega$   pF	
Common Mode				100  2			100  2	G $\Omega$   pF	
Input Operating Voltage Range <sup>3</sup>	$V_S = \pm 2.3\text{ V to } \pm 5\text{ V}$ $T_A = -40^{\circ}\text{C to } +85^{\circ}\text{C}$	$-V_S + 1.9$		$+V_S - 1.1$	$-V_S + 1.9$		$+V_S - 1.1$	V	
Over Temperature			$-V_S + 2.0$		$+V_S - 1.2$	$-V_S + 2.0$		$+V_S - 1.2$	V
Input Operating Voltage Range <sup>3</sup>	$V_S = \pm 5\text{ V to } \pm 18\text{ V}$ $T_A = -40^{\circ}\text{C to } +85^{\circ}\text{C}$	$-V_S + 1.9$		$+V_S - 1.2$	$-V_S + 1.9$		$+V_S - 1.2$	V	
Over Temperature			$-V_S + 2.0$		$+V_S - 1.2$	$-V_S + 2.0$		$+V_S - 1.2$	V
OUTPUT	$R_L = 10\text{ k}\Omega$								
Output Swing	$V_S = \pm 2.3\text{ V to } \pm 5\text{ V}$ $T_A = -40^{\circ}\text{C to } +85^{\circ}\text{C}$	$-V_S + 1.1$		$+V_S - 1.2$	$-V_S + 1.1$		$+V_S - 1.2$	V	
Over Temperature			$-V_S + 1.4$		$+V_S - 1.3$	$-V_S + 1.4$		$+V_S - 1.3$	V
Output Swing	$V_S = \pm 5\text{ V to } \pm 18\text{ V}$ $T_A = -40^{\circ}\text{C to } +85^{\circ}\text{C}$	$-V_S + 1.2$		$+V_S - 1.4$	$-V_S + 1.2$		$+V_S - 1.4$	V	
Over Temperature			$-V_S + 1.6$		$+V_S - 1.5$	$-V_S + 1.6$		$+V_S - 1.5$	V
Short-Circuit Current			18			18		mA	
POWER SUPPLY									
Operating Range	$V_S = \pm 2.3\text{ V to } \pm 18\text{ V}$	$\pm 2.3$		$\pm 18$	$\pm 2.3$		$\pm 18$	V	
Quiescent Current (per Amplifier)	$T_A = -40^{\circ}\text{C to } +85^{\circ}\text{C}$		0.9	1.1		0.9	1.1	mA	
Over Temperature				1	1.2		1	1.2	mA
TEMPERATURE RANGE									
Specified Performance		-40		+85	-40		+85	$^{\circ}\text{C}$	
Operational <sup>4</sup>		-40		+125	-40		+125	$^{\circ}\text{C}$	

<sup>1</sup> Refers to differential configuration shown in Figure 50.

<sup>2</sup> Does not include the effects of external resistor,  $R_G$ .

<sup>3</sup> One input grounded.  $G = 1$ .

<sup>4</sup> See the Typical Performance Characteristics section for expected operation between  $85^{\circ}\text{C}$  and  $125^{\circ}\text{C}$ .

$V_S = \pm 15\text{ V}$ ,  $V_{REF} = 0\text{ V}$ ,  $T_A = 25^\circ\text{C}$ ,  $R_L = 2\text{ k}\Omega$ , unless otherwise noted.

**Table 3. Single-Ended Output Configuration—Dynamic Performance (Both Amplifiers)**

Parameter	Test Conditions/Comments	A Grade			B Grade			Unit
		Min	Typ	Max	Min	Typ	Max	
DYNAMIC RESPONSE								
Small Signal –3 dB Bandwidth								
G = 1			1200		1200			kHz
G = 10			750		750			kHz
G = 100			140		140			kHz
G = 1000			15		15			kHz
Settling Time 0.01%	10 V step							
G = 1 to 100			10		10			$\mu\text{s}$
G = 1000			80		80			$\mu\text{s}$
Settling Time 0.001%	10 V step							
G = 1 to 100			13		13			$\mu\text{s}$
G = 1000			110		110			$\mu\text{s}$
Slew Rate	G = 1	1.5	2		1.5	2		V/ $\mu\text{s}$
	G = 5 to 1000	2	2.5		2	2.5		V/ $\mu\text{s}$

**Table 4. Differential Output Configuration<sup>1</sup>—Dynamic Performance**

Parameter	Test Conditions/Comments	A Grade			B Grade			Unit
		Min	Typ	Max	Min	Typ	Max	
DYNAMIC RESPONSE								
Small Signal –3 dB Bandwidth								
G = 1			1000		1000			kHz
G = 10			650		650			kHz
G = 100			140		140			kHz
G = 1000			15		15			kHz
Settling Time 0.01%	10 V step							
G = 1 to 100			15		15			$\mu\text{s}$
G = 1000			80		80			$\mu\text{s}$
Settling Time 0.001%	10 V step							
G = 1 to 100			18		18			$\mu\text{s}$
G = 1000			110		110			$\mu\text{s}$
Slew Rate	G = 1	1.5	2		1.5	2		V/ $\mu\text{s}$
	G = 5 to 1000	2	2.5		2	2.5		V/ $\mu\text{s}$

<sup>1</sup> Refers to differential configuration shown in Figure 50.

## ABSOLUTE MAXIMUM RATINGS

Table 5.

Parameter	Rating
Supply Voltage	$\pm 18$ V
Output Short-Circuit Current Duration	Indefinite
Input Voltage (Common Mode)	$\pm V_s$
Differential Input Voltage	$\pm V_s$
Storage Temperature Range	$-65^{\circ}\text{C}$ to $+130^{\circ}\text{C}$
Operational Temperature Range	$-40^{\circ}\text{C}$ to $+125^{\circ}\text{C}$
Package Glass Transition Temperature ( $T_G$ )	$130^{\circ}\text{C}$
ESD	
Human Body Model	2 kV
Charge Device Model	1 kV

Stresses at or above those listed under Absolute Maximum Ratings may cause permanent damage to the product. This is a stress rating only; functional operation of the product at these or any other conditions above those indicated in the operational section of this specification is not implied. Operation beyond the maximum operating conditions for extended periods may affect product reliability.

## THERMAL RESISTANCE

Table 6.

Package	$\theta_{JA}$	Unit
CP-16-19: LFCSP Without Thermal Pad	86	$^{\circ}\text{C}/\text{W}$
CP-16-26: LFCSP with Thermal Pad	48	$^{\circ}\text{C}/\text{W}$

The  $\theta_{JA}$  values in Table 6 assume a 4-layer JEDEC standard board. For the LFCSP with thermal pad, it is assumed that the thermal pad is soldered to a landing on the PCB board, with the landing thermally connected to a heat dissipating power plane.  $\theta_{JC}$  at the exposed pad is  $4.4^{\circ}\text{C}/\text{W}$ .

### Maximum Power Dissipation

The maximum safe power dissipation for the AD8222 is limited by the associated rise in junction temperature ( $T_j$ ) on the die. At approximately  $130^{\circ}\text{C}$ , which is the glass transition temperature, the plastic changes its properties. Even temporarily exceeding this temperature limit may change the stresses that the package exerts on the die, permanently shifting the parametric performance of the amplifiers. Exceeding a temperature of  $130^{\circ}\text{C}$  for an extended period can result in a loss of functionality.

## ESD CAUTION



**ESD (electrostatic discharge) sensitive device.** Charged devices and circuit boards can discharge without detection. Although this product features patented or proprietary protection circuitry, damage may occur on devices subjected to high energy ESD. Therefore, proper ESD precautions should be taken to avoid performance degradation or loss of functionality.

### PIN CONFIGURATIONS AND FUNCTION DESCRIPTIONS



Figure 2. 16-Lead LFCSP (CP-16-19) Pin Configuration



NOTES  
1. THE EXPOSED PAD MUST BE CONNECTED TO -Vs.

Figure 3. 16-Lead LFCSP (CP-16-26) Pin Configuration

Table 7. Pin Function Descriptions

Pin No.		Mnemonic	Description
CP-16-19	CP-16-26		
1	1	-IN1	Negative Input In-Amp 1.
2, 3	2, 3	RG1	Gain Resistor In-Amp 1.
4	4	+IN1	Positive Input In-Amp 1.
5, 16	5, 16	+Vs	Positive Supply.
6	6	REF1	Reference Adjust In-Amp 1.
7	7	REF2	Reference Adjust In-Amp 2.
8, 13	8, 13	-Vs	Negative Supply.
9	9	+IN2	Positive Input In-Amp 2.
10, 11	10, 11	RG2	Gain Resistor In-Amp 2.
12	12	-IN2	Negative Input In-Amp 2.
14	14	OUT2	Output In-Amp 2.
15	15	OUT1	Output In-Amp 1.
Not applicable	0	EPAD	Exposed Pad. The exposed pad must be connected to -Vs.

TYPICAL PERFORMANCE CHARACTERISTICS



Figure 4. Typical Distribution for CMRR (G = 1)



Figure 7. Typical Distribution of Input Offset Current

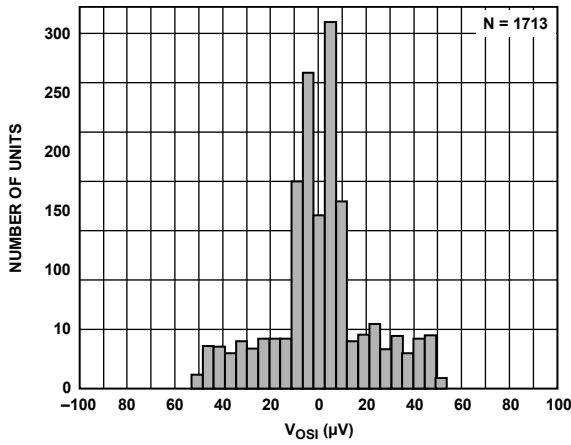

Figure 5. Typical Distribution of Input Offset Voltage

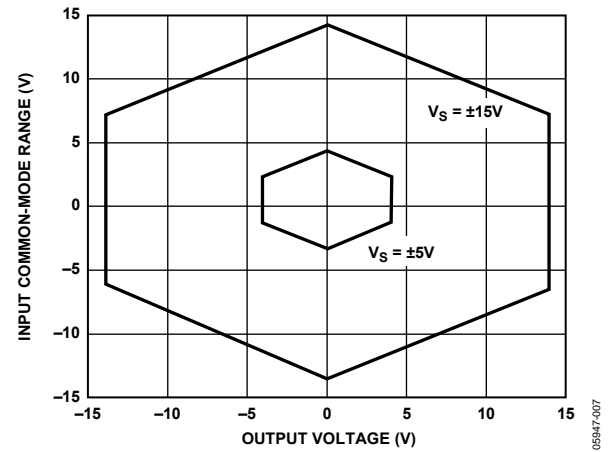

Figure 8. Input Common-Mode Range vs. Output Voltage, G = 1

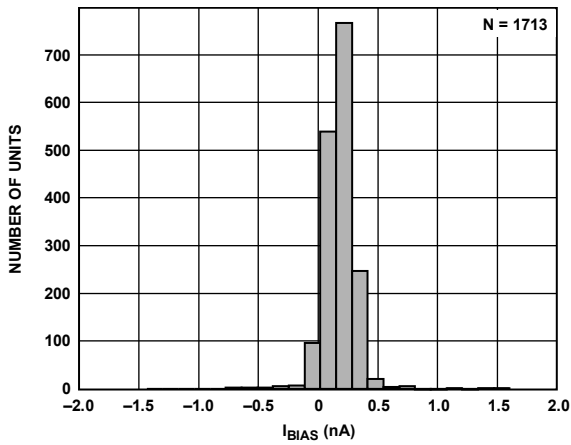

Figure 6. Typical Distribution of Input Bias Current

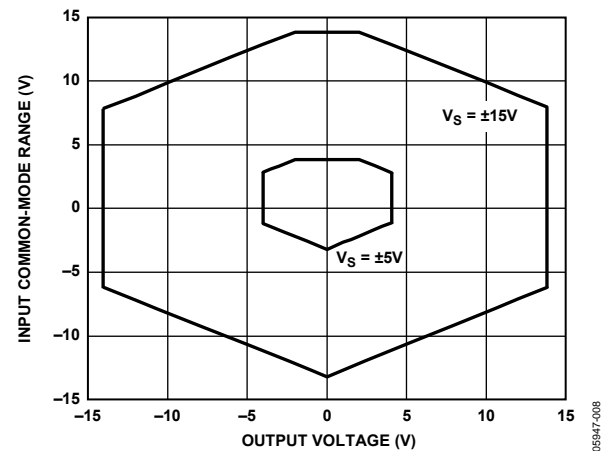

Figure 9. Input Common-Mode Range vs. Output Voltage, G = 100





Figure 10.  $I_{BIAS}$  vs. Common-Mode Voltage

05947-009



Figure 13. Positive PSRR vs. Frequency, RTI ( $G = 1$  to 1000)

05947-012



Figure 11. Change in Input Offset Voltage vs. Warm-Up Time

05947-010



Figure 14. Negative PSRR vs. Frequency, RTI ( $G = 1$  to 1000)

05947-013



Figure 12. Input Bias Current and Offset Current vs. Temperature

05947-011



Figure 15. Total Drift vs. Source Resistance

05947-014



Figure 16. Gain vs. Frequency

05947-015



Figure 19.  $\Delta$ CMR vs. Temperature,  $G = 1$

05947-018



Figure 17. CMRR vs. Frequency, RTI

05947-016



Figure 20. Input Voltage Limit vs. Supply Voltage,  $G = 1$

05947-019



Figure 18. CMRR vs. Frequency, RTI, 1 k $\Omega$  Source Imbalance

05947-017



Figure 21. Output Voltage Swing vs. Supply Voltage,  $G = 1$

05947-020



Figure 22. Output Voltage Swing vs. Load Resistance



Figure 25. Gain Nonlinearity,  $G = 100$



Figure 23. Output Voltage Swing vs. Output Current,  $G = 1$



Figure 26. Voltage Noise Spectral Density vs. Frequency ( $G = 1$  to 1000)



Figure 24. Gain Nonlinearity,  $G = 1$



Figure 27. 0.1 Hz to 10 Hz RTI Voltage Noise ( $G = 1$ )



Figure 28. 0.1 Hz to 10 Hz RTI Voltage Noise ( $G = 1000$ )



Figure 31. Large Signal Frequency Response



Figure 29. Current Noise Spectral Density vs. Frequency



Figure 32. Large Signal Pulse Response and Settling Time ( $G = 1$ )



Figure 30. 0.1 Hz to 10 Hz Current Noise



Figure 33. Large Signal Pulse Response and Settling ( $G = 10$ )



Figure 34. Large Signal Pulse Response and Settling Time ( $G = 100$ )



Figure 37. Small Signal Response,  $G = 10$ ,  $R_L = 2\text{ k}\Omega$ ,  $C_L = 100\text{ pF}$



Figure 35. Large Signal Pulse Response and Settling Time ( $G = 1000$ )



Figure 38. Small Signal Response,  $G = 100$ ,  $R_L = 2\text{ k}\Omega$ ,  $C_L = 100\text{ pF}$



Figure 36. Small Signal Response,  $G = 1$ ,  $R_L = 2\text{ k}\Omega$ ,  $C_L = 100\text{ pF}$



Figure 39. Small Signal Response,  $G = 1000$ ,  $R_L = 2\text{ k}\Omega$ ,  $C_L = 100\text{ pF}$



Figure 40. Settling Time vs. Step Size ( $G = 1$ )

05947-040



Figure 43. Differential Output Configuration: Gain vs. Frequency

05947-043



Figure 41. Settling Time vs. Gain for a 10 V Step

05947-041



Figure 44. Differential Output Configuration: Output Balance vs. Frequency

05947-056



Figure 42. Channel Separation vs. Frequency,  $R_L = 2\text{ k}\Omega$ , Source Channel at  $G = 1$

05947-042

## THEORY OF OPERATION



Figure 45. Simplified Schematic

### AMPLIFIER ARCHITECTURE

The two instrumentation amplifiers of the AD8222 are based on the classic 3-op-amp topology. Figure 45 shows a simplified schematic of one of the amplifiers. The input transistors, Q1 and Q2, are biased at a fixed current. Any differential input signal forces the output voltages of A1 and A2 to change so that the differential voltage also appears across  $R_G$ . The current that flows through  $R_G$  must also flow through R1 and R2, resulting in a precisely amplified version of the differential input signal between the outputs of A1 and A2. Topologically, Q1 + A1 + R1 and Q2 + A2 + R2 can be viewed as precision current feedback amplifiers. The common-mode signal and the amplified differential signal are applied to a difference amplifier that rejects the common-mode voltage. The difference amplifier employs innovations that result in low output offset voltage as well as low output offset voltage drift.

Because the input amplifiers employ a current feedback architecture, the gain-bandwidth product of the AD8222 increases with gain, resulting in a system that does not suffer from the expected bandwidth loss of voltage feedback architectures at higher gains.

The transfer function of the AD8222 is

$$V_{OUT} = G(V_{+IN} - V_{-IN}) + V_{REF}$$

where:

$$G = 1 + \frac{49.4 \text{ k}\Omega}{R_G}$$

### GAIN SELECTION

Placing a resistor across the  $R_G$  terminals sets the gain of the AD8222, which can be calculated by referring to Table 8 or by using the following gain equation:

$$R_G = \frac{49.4 \text{ k}\Omega}{G - 1}$$

Table 8. Gains Achieved Using 1% Resistors

1% Standard Table Value of $R_G$ ( $\Omega$ )	Calculated Gain
49.9 k	1.990
12.4 k	4.984
5.49 k	9.998
2.61 k	19.93
1.00 k	50.40
499	100.0
249	199.4
100	495.0
49.9	991.0

The AD8222 defaults to  $G = 1$  when no gain resistor is used. The tolerance and gain drift of the  $R_G$  resistor should be added to the AD8222 specifications to determine the total gain accuracy of the system. When the gain resistor is not used, gain error and gain drift are kept to a minimum.

## REFERENCE TERMINAL

The output voltage of an [AD8222](#) channel is developed with respect to the potential on the corresponding reference terminal. Typically, the reference terminal is connected to ground, but it can also be driven with a voltage to offset the output signal. For example, connect a voltage to the reference terminal to level-shift the output so that the [AD8222](#) can drive a single-supply ADC. Both REF1 and REF2 are protected with ESD diodes and should not exceed either  $+V_S$  or  $-V_S$  by more than 0.3 V.

For best performance, source impedance to a reference terminal should be kept below  $1\ \Omega$ . As shown in Figure 45, the reference terminal is at one end of a  $10\ \text{k}\Omega$  resistor. Additional impedance at the reference terminal adds to this  $10\ \text{k}\Omega$  resistor and results in amplification of the signal connected to the positive input. The amplification from the additional  $R_{REF}$  can be computed by

$$\frac{2(10\ \text{k}\Omega + R_{REF})}{20\ \text{k}\Omega + R_{REF}}$$

Only the positive signal path is amplified; the negative path is unaffected. This uneven amplification degrades the CMRR of the amplifier.



Figure 46. Driving the Reference Pin

## PACKAGE CONSIDERATIONS

The [AD8222](#) comes in a  $4\ \text{mm} \times 4\ \text{mm}$  LFCSP. Beware of blindly copying the footprint from another  $4\ \text{mm} \times 4\ \text{mm}$  LFCSP device; the landing pattern may be different. Refer to the Outline Dimensions section to verify that the PCB symbol has the correct dimensions.

The [AD8222](#) comes in two package varieties, both with and without a thermal pad.

### Package Without Thermal Pad

The [AD8222](#) ships with a package that does not include a thermal pad; it is the preferred package for the [AD8222](#). Unlike chip scale packages where the pad limits routing capability, the [AD8222](#) package allows routes and vias directly underneath the chip, so that the full space savings of the small LFCSP can be realized.

Although the package has no metal in the center of the device, the manufacturing process does leave a very small section of exposed metal at each of the package corners, shown in Figure 56

in the Outline Dimensions section. This metal is connected to  $-V_S$  through the device. Because of a possibility of a short, vias should not be placed underneath this exposed metal.

### Package with Thermal Pad

This package is included primarily for legacy reasons. Because the [AD8222](#) dissipates so little power, there is little need for the thermal pad.

The thermal pad is connected internally to  $-V_S$ . The pad can either be left unsoldered, soldered to an otherwise unconnected PCB landing, or soldered to a landing connected to the negative supply rail ( $-V_S$ ). If pin compatibility with the [AD8224](#) is desired, the pad should not be electrically connected to any net, including  $-V_S$ .

The solder process can leave flux and other contaminants on the board. When these contaminants are between the [AD8222](#) leads and thermal pad, they can create leakage paths that are larger than the bias currents of the [AD8222](#). A thorough washing process removes these contaminants and restores the excellent bias current performance of the [AD8222](#).

## LAYOUT

The [AD8222](#) is a high precision device. To ensure optimum performance at the PC board level, take care in the design of the board layout. The [AD8222](#) pinout is arranged in a logical manner to aid in this task.

### Common-Mode Rejection Over Frequency

The [AD8222](#) has a higher CMRR over frequency than typical in-amps, which gives it greater immunity to disturbances, such as line noise and its associated harmonics. A well-implemented layout is required to maintain this high performance. Input source impedances should be matched closely. Source resistance should be placed close to the inputs so that it interacts with as little parasitic capacitance as possible.

Parasitics at the  $RGx$  pins can also affect CMRR over frequency. The PCB should be laid out so that the parasitic capacitances at each pin match. Traces from the gain setting resistor to the  $RGx$  pins should be kept short to minimize parasitic inductance.

### Reference

Errors introduced at the reference terminal feed directly to the output. Take care to tie REF to the appropriate local ground.

### Power Supplies

Use a stable dc voltage to power the instrumentation amplifier. Noise on the supply pins can adversely affect performance.

The [AD8222](#) has two positive supply pins (Pin 5 and Pin 16) and two negative supply pins (Pin 8 and Pin 13). Although the device functions with only one pin from each supply pair connected, both pins should be connected for specified performance and optimum reliability.



The AD8222 should be decoupled with 0.1 μF bypass capacitors, one for each supply. The positive supply decoupling capacitor should be placed near Pin 16, and the negative supply decoupling capacitor should be placed near Pin 8. Each supply should also be decoupled with a 10 μF tantalum capacitor. The tantalum capacitor can be placed further away from the AD8222 and can generally be shared by other precision integrated circuits. Figure 47 shows an example layout.



Figure 47. Example Layout

05947-046

### INPUT BIAS CURRENT RETURN PATH

The input bias current of the AD8222 must have a return path to common. When the source, such as a thermocouple, cannot provide a return current path, one should be created, as shown in Figure 48.



Figure 48. Creating an  $I_{BIAS}$  Path

05947-047

## INPUT PROTECTION

All terminals of the AD8222 are protected against ESD (2 kV, human body model). In addition, the input structure allows for dc overload conditions of about 2.5 V beyond the supplies.

### Input Voltages Beyond the Rails

For larger input voltages, an external resistor should be used in series with each input to limit current during overload conditions. The AD8222 can safely handle a continuous 6 mA current. The limiting resistor can be computed from

$$R_{LIMIT} \geq \frac{V_{IN} - V_{SUPPLY}}{6 \text{ mA}} - 400 \Omega$$

For applications in which the AD8222 encounters extreme overload voltages, such as cardiac defibrillators, external series resistors and low leakage diode clamps, such as the BAV199L, the FJH1100, or the SP720, should be used.

### Differential Input Voltages at High Gains

When operating at high gain, large differential input voltages can cause more than 6 mA of current to flow into the inputs. This condition occurs when the differential voltage exceeds the following critical voltage:

$$V_{CRITICAL} = (400 + R_G) \times (6 \text{ mA})$$

This is true for differential voltages of either polarity.

The maximum allowed differential voltage can be increased by adding an input protection resistor in series with each input. The value of each protection resistor should be

$$R_{PROTECT} = (V_{DIFF\_MAX} - V_{CRITICAL})/6 \text{ mA}$$

## RF INTERFERENCE

RF rectification is often a problem when amplifiers are used in applications where there are strong RF signals. The disturbance can appear as a small dc offset voltage. High frequency signals can be filtered with a low-pass, RC network placed at the input of the instrumentation amplifier, as shown in Figure 49. The filter limits the input signal bandwidth according to the following relationship:

$$FilterFreq_{DIFF} = \frac{1}{2\pi R(2C_D + C_C)}$$

$$FilterFreq_{CM} = \frac{1}{2\pi R \times C_C}$$

where  $C_D \geq 10C_C$ .



Figure 49. RFI Suppression

Figure 49 shows an example where the differential filter frequency is approximately 2 kHz, and the common-mode filter frequency is approximately 40 kHz.

Values of R and  $C_C$  should be chosen to minimize RFI. Mismatch between the  $R \times C_C$  at the positive input and the  $R \times C_C$  at negative input degrades the CMRR of the AD8222. By using a value of  $C_D$  10× larger than the value of  $C_C$ , the effect of the mismatch is reduced and performance is improved.

## COMMON-MODE INPUT VOLTAGE RANGE

The 3-op-amp architecture of the AD8222 applies gain and then removes the common-mode voltage. Therefore, internal nodes in the AD8222 experience a combination of both the gained signal and the common-mode signal. This combined signal can be limited by the voltage supplies even when the individual input and output signals are not. Figure 8 and Figure 9 show the allowable common-mode input voltage ranges for various output voltages, supply voltages, and gains.

# APPLICATIONS INFORMATION

## DIFFERENTIAL OUTPUT

The differential configuration of the AD8222 has the same excellent dc precision specifications as the single-ended output configuration and is recommended for applications in the frequency range of dc to 100 kHz.

The circuit configuration is shown in Figure 50. The differential output specifications in Table 2 and Table 4 refer to this configuration only. The circuit includes an RC filter that maintains the stability of the loop.

The transfer function for the differential output is:

$$V_{DIFF\_OUT} = V_{+OUT} - V_{-OUT} = (V_{+IN} - V_{-IN}) \times G$$

where:

$$G = 1 + \frac{49.4 \text{ k}\Omega}{R_G}$$

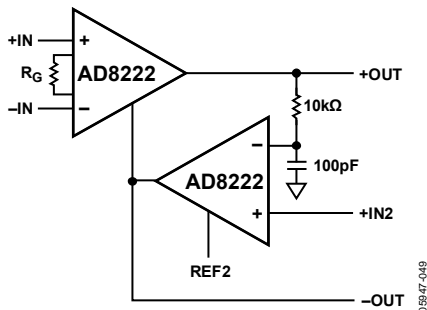

Figure 50. Differential Circuit Schematic

## Setting the Common-Mode Voltage

The output common-mode voltage is set by the average of +IN2 and REF2. The transfer function is

$$V_{CM\_OUT} = (V_{+OUT} + V_{-OUT})/2 = (V_{+IN2} + V_{REF2})/2$$

+IN2 and REF2 have different properties that allow the reference voltage to be easily set for a wide variety of applications. +IN2 has high impedance but cannot swing to the supply rails of the device. REF2 must be driven with a low impedance but can go 300 mV beyond the supply rails.

A common application sets the common-mode output voltage to the midscale of a differential ADC. In this case, the ADC reference voltage is sent to the +IN2 terminal, and ground is connected to the REF2 terminal. This produces a common-mode output voltage of half the ADC reference voltage.

## 2-Channel Differential Output Using a Dual Op Amp

Another differential output topology is shown in Figure 51. Instead of a second in-amp, 1/2 of a dual OP2177 op amp creates the inverted output. Because the OP2177 is packaged in an MSOP, this configuration allows the creation of a dual channel, precision differential output in-amp with little board area.

Errors from the op amp are common to both outputs and are thus common mode. Errors from mismatched resistors also create a common-mode dc offset. Because these errors are common mode, they are likely to be rejected by the next device in the signal chain.



Figure 51. Differential Output Using Op Amp



Figure 52. Driving a Differential ADC

## DRIVING A DIFFERENTIAL INPUT ADC

The [AD8222](#) can be configured in differential output mode to drive a differential analog-to-digital converter. Figure 52 illustrates several of the concepts.

### RFI and Antialiasing Filter

The 1 kΩ resistors, 1000 pF capacitor, and 100 pF capacitors in front of the in-amp form filter circuitry that performs many functions. The 1 kΩ and 100 pF capacitors form common-mode filters that protect the amplifier from incoming radio frequency signals. Without the filtering, these RFI signals can be rectified in the in-amp. The 1 kΩ resistors provide some overvoltage protection. The 1 kΩ resistors and 1000 pF capacitor form a 76 kHz antialiasing filter for the ADC.

Note that the 100 pF capacitors are 5% COG/NPO types. These capacitors match well over time and temperature, which keeps the system CMRR high over frequency.

### Second Antialiasing Filter

A 1 kΩ resistor and 2200 pF capacitor are placed between each [AD8222](#) output and ADC input. They create a 72 kHz low-pass filter for another stage of antialiasing protection.

These four elements also improve distortion performance. The 2200 pF capacitor provides charge to the switched capacitor front end of the ADC, and the 1 kΩ resistor shields the [AD8222](#) from driving any sharp current changes. If the application requires a lower frequency antialiasing filter and is distortion sensitive, increase the value of the capacitor rather than the resistor.

The 1 kΩ resistors can also protect an ADC from overvoltages. Because the [AD8222](#) runs on wider supply voltages than a typical ADC, there is a possibility of overdriving the ADC. This is not an issue with a PulsAR® converter, such as the [AD7688](#). Its input can handle a 130 mA overdrive, which is much higher than the short-circuit limit of the [AD8222](#). However, other converters have less robust inputs and may need the added protection.

### Reference

The [ADR435](#) supplies a reference voltage to both the ADC and the [AD8222](#). Because REF2 on the [AD8222](#) is grounded, the common-mode output voltage is precisely half the reference voltage, exactly where it needs to be for the ADC.

## PRECISION STRAIN GAGE

The low offset and high CMRR over frequency of the [AD8222](#) make it an excellent candidate for both ac and dc bridge measurements. As shown in Figure 53, the bridge can be connected to the inputs of the amplifier directly.



Figure 53. Precision Strain Gauge

### DRIVING CABLING

All cables have a certain capacitance per unit length, which varies widely with cable type. The capacitive load from the cable can cause peaking in the output response of the AD8222. To reduce the peaking, use a resistor between the AD8222 and the cable. Because cable capacitance and desired output response vary widely, this resistor is best determined empirically. A good starting point is 50  $\Omega$ .

The AD8222 operates at a low enough frequency that transmission line effects are rarely an issue; therefore, the resistor need not match the characteristic impedance of the cable.

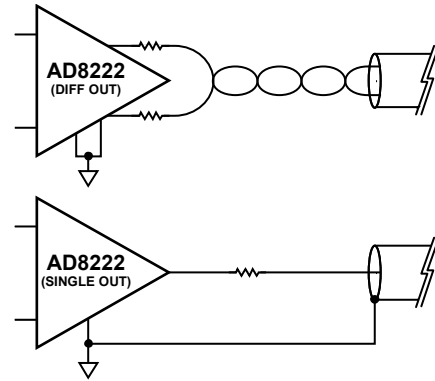
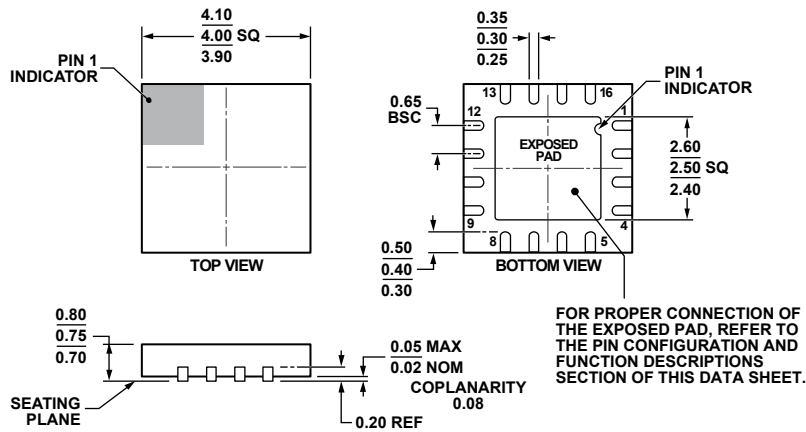

Figure 54. Driving a Cable

OUTLINE DIMENSIONS



COMPLIANT TO JEDEC STANDARDS MO-220-WGGC.

Figure 55. 16-Lead Lead Frame Chip Scale Package [LFCSPP]  
4 mm x 4 mm Body and 0.75 mm Package Height  
(CP-16-26)

Dimensions are shown in millimeters

042709-A

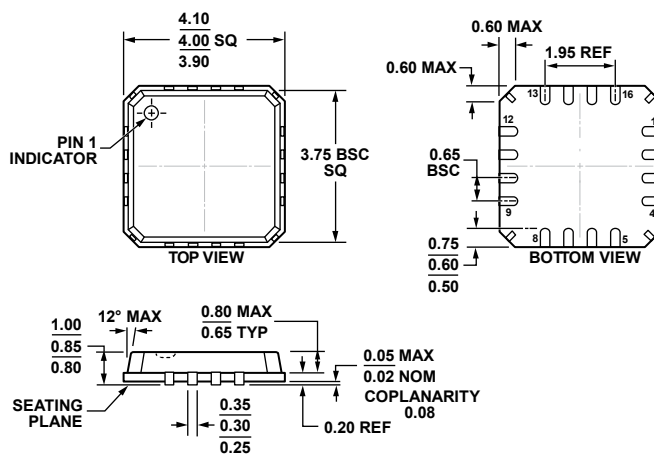

COMPLIANT TO JEDEC STANDARDS MO-263-VBBC

Figure 56. 16-Lead Lead Frame Chip Scale Package [LFCSPP]  
4 mm x 4 mm Body and 0.85 mm Package Height with Hidden Paddle  
(CP-16-19)

Dimensions shown in millimeters

04-06-2012-A

## ORDERING GUIDE

Model <sup>1</sup>	Temperature Range	Product Description	Package Description	Package Option
AD8222ACPZ-R7	–40°C to +85°C	Standard Grade with Exposed Pad	16-Lead LFCSP, 7" Tape and Reel	CP-16-26
AD8222ACPZ-RL	–40°C to +85°C	Standard Grade with Exposed Pad	16-Lead LFCSP, 13" Tape and Reel	CP-16-26
AD8222ACPZ-WP	–40°C to +85°C	Standard Grade with Exposed Pad	16-Lead LFCSP, Waffle Pack	CP-16-26
AD8222BCPZ-R7	–40°C to +85°C	High Performance Grade with Exposed Pad	16-Lead LFCSP, 7" Tape and Reel	CP-16-26
AD8222BCPZ-RL	–40°C to +85°C	High Performance Grade with Exposed Pad	16-Lead LFCSP, 13" Tape and Reel	CP-16-26
AD8222BCPZ-WP	–40°C to +85°C	High Performance Grade with Exposed Pad	16-Lead LFCSP, Waffle Pack	CP-16-26
AD8222HACPZ-R7	–40°C to +85°C	Standard Grade Without Exposed Pad	16-Lead LFCSP, 7" Tape and Reel	CP-16-19
AD8222HACPZ-RL	–40°C to +85°C	Standard Grade Without Exposed Pad	16-Lead LFCSP, 13" Tape and Reel	CP-16-19
AD8222HACPZ-WP	–40°C to +85°C	Standard Grade Without Exposed Pad	16-Lead LFCSP, Waffle Pack	CP-16-19
AD8222HBCPZ-R7	–40°C to +85°C	High Performance Grade Without Exposed Pad	16-Lead LFCSP, 7" Tape and Reel	CP-16-19
AD8222HBCPZ-RL	–40°C to +85°C	High Performance Grade Without Exposed Pad	16-Lead LFCSP, 13" Tape and Reel	CP-16-19
AD8222HBCPZ-WP	–40°C to +85°C	High Performance Grade Without Exposed Pad	16-Lead LFCSP, Waffle Pack	CP-16-19
AD8222-EVALZ			Evaluation Board	

<sup>1</sup> Z = RoHS Compliant Part.

**NOTES**



## Данный компонент на территории Российской Федерации

### Вы можете приобрести в компании MosChip.

Для оперативного оформления запроса Вам необходимо перейти по данной ссылке:

<http://moschip.ru/get-element>

Вы можете разместить у нас заказ для любого Вашего проекта, будь то серийное производство или разработка единичного прибора.

В нашем ассортименте представлены ведущие мировые производители активных и пассивных электронных компонентов.

Нашей специализацией является поставка электронной компонентной базы двойного назначения, продукции таких производителей как XILINX, Intel (ex.ALTERA), Vicor, Microchip, Texas Instruments, Analog Devices, Mini-Circuits, Amphenol, Glenair.

Сотрудничество с глобальными дистрибьюторами электронных компонентов, предоставляет возможность заказывать и получать с международных складов практически любой перечень компонентов в оптимальные для Вас сроки.

На всех этапах разработки и производства наши партнеры могут получить квалифицированную поддержку опытных инженеров.

Система менеджмента качества компании отвечает требованиям в соответствии с ГОСТ Р ИСО 9001, ГОСТ РВ 0015-002 и ЭС РД 009

### Офис по работе с юридическими лицами:

105318, г.Москва, ул.Щербаковская д.3, офис 1107, 1118, ДЦ «Щербаковский»

Телефон: +7 495 668-12-70 (многоканальный)

Факс: +7 495 668-12-70 (доб.304)

E-mail: [info@moschip.ru](mailto:info@moschip.ru)

Skype отдела продаж:

moschip.ru

moschip.ru\_4

moschip.ru\_6

moschip.ru\_9