

# BDX33B, BDX33C (NPN) BDX34B, BDX34C (PNP)



ON Semiconductor®

<http://onsemi.com>

## Darlington Complementary Silicon Power Transistors

These devices are designed for general purpose and low speed switching applications.

### Features

- High DC Current Gain –  $h_{FE} = 2500$  (typ.) at  $I_C = 4.0$
- Collector–Emitter Sustaining Voltage at 100 mAdc  
 $V_{CEO(sus)} = 80$  Vdc (min) – BDX33B, BDX334B  
 $= 100$  Vdc (min) – BDX33C, BDX334C
- Low Collector–Emitter Saturation Voltage  
 $V_{CE(sat)} = 2.5$  Vdc (max) at  $I_C = 3.0$  Adc  
– BDX33B, 33C/34B, 34C
- Monolithic Construction with Build–In Base–Emitter Shunt Resistors
- Pb–Free Packages are Available\*

### MAXIMUM RATINGS

Rating	Symbol	Value	Unit
Collector–Emitter Voltage BDX33B, BDX34B BDX33C, BDX34C	$V_{CEO}$	80 100	Vdc
Collector–Base Voltage BDX33B, BDX34B BDX33C, BDX34C	$V_{CB}$	80 100	Vdc
Emitter–Base Voltage	$V_{EB}$	5.0	Vdc
Collector Current – Continuous – Peak	$I_C$	10 15	Adc
Base Current	$I_B$	0.25	Adc
Total Device Dissipation @ $T_C = 25^\circ\text{C}$ Derate above $25^\circ\text{C}$	$P_D$	70 0.56	W W/ $^\circ\text{C}$
Operating and Storage Junction Temperature Range	$T_J, T_{stg}$	–65 to +150	$^\circ\text{C}$

### THERMAL CHARACTERISTICS

Characteristics	Symbol	Max	Unit
Thermal Resistance, Junction–to–Case	$R_{\theta JC}$	1.78	$^\circ\text{C}/\text{W}$

Stresses exceeding Maximum Ratings may damage the device. Maximum Ratings are stress ratings only. Functional operation above the Recommended Operating Conditions is not implied. Extended exposure to stresses above the Recommended Operating Conditions may affect device reliability.

## DARLINGTON 10 AMPERE COMPLEMENTARY SILICON POWER TRANSISTORS 80–100 VOLTS, 65 WATTS

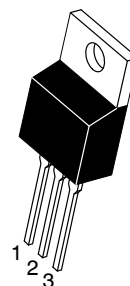

TO-220AB  
CASE 221A-09  
STYLE 1

### MARKING DIAGRAM



BDX3xy = Device Code  
x = 3 or 4  
y = B or C  
A = Assembly Location  
Y = Year  
WW = Work Week  
G = Pb–Free Package

### ORDERING INFORMATION

See detailed ordering and shipping information in the package dimensions section on page 5 of this data sheet.

\*For additional information on our Pb–Free strategy and soldering details, please download the ON Semiconductor Soldering and Mounting Techniques Reference Manual, SOLDERRM/D.

## BDX33B, BDX33C (NPN) BDX34B, BDX34C (PNP)

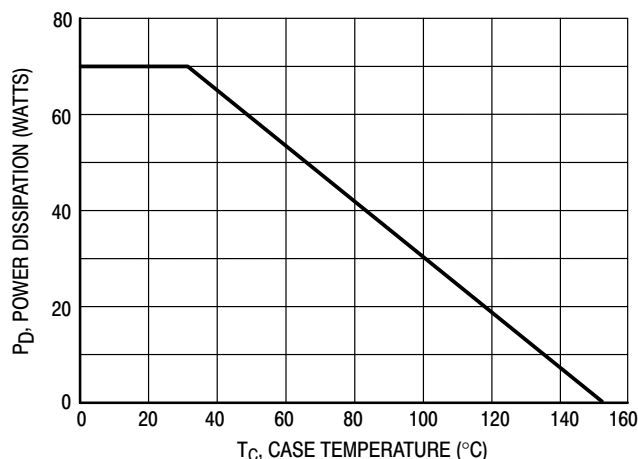

**Figure 1. Power Derating**

### ELECTRICAL CHARACTERISTICS (T<sub>C</sub> = 25°C unless otherwise noted)

Characteristic	Symbol	Min	Max	Unit	
<b>OFF CHARACTERISTICS</b>					
Collector–Emitter Sustaining Voltage (Note 1) (I <sub>C</sub> = 100 mAdc, I <sub>B</sub> = 0)	BDX33B/BDX34B BDX33C/BDX34C	V <sub>CEO(sus)</sub>	80 100	– –	Vdc
Collector–Emitter Sustaining Voltage (Note 1) (I <sub>C</sub> = 100 mAdc, I <sub>B</sub> = 0, R <sub>BE</sub> = 100)	BDX33B/BDX34B BDX33C/BDX33C	V <sub>CER(sus)</sub>	80 100	– –	Vdc
Collector–Emitter Sustaining Voltage (Note 1) (I <sub>C</sub> = 100 mAdc, I <sub>B</sub> = 0, V <sub>BE</sub> = 1.5 Vdc)	BDX33B/BDX34B BDX33C/BDX34C	V <sub>CEX(sus)</sub>	80 100	– –	Vdc
Collector Cutoff Current (V <sub>CE</sub> = 1/2 rated V <sub>CEO</sub> , I <sub>B</sub> = 0)	T <sub>C</sub> = 25°C T <sub>C</sub> = 100°C	I <sub>CEO</sub>	– –	0.5 10	mAdc
Collector Cutoff Current (V <sub>CB</sub> = rated V <sub>CB0</sub> , I <sub>E</sub> = 0)	T <sub>C</sub> = 25°C T <sub>C</sub> = 100°C	I <sub>CBO</sub>	– –	1.0 5.0	mAdc
Emitter Cutoff Current (V <sub>BE</sub> = 5.0 Vdc, I <sub>C</sub> = 0)		I <sub>EBO</sub>	–	10	mAdc
<b>ON CHARACTERISTICS</b>					
DC Current Gain (Note 1) (I <sub>C</sub> = 3.0 Adc, V <sub>CE</sub> = 3.0 Vdc)	BDX33B, 33C/34B, 34C	h <sub>FE</sub>	750	–	–
Collector–Emitter Saturation Voltage (I <sub>C</sub> = 3.0 Adc, I <sub>B</sub> = 6.0 mAdc)	BDX33B, 33C/34B, 34C	V <sub>CE(sat)</sub>	–	2.5	Vdc
Base–Emitter On Voltage (I <sub>C</sub> = 3.0 Adc, V <sub>CE</sub> = 3.0 Vdc)	BDX33B, 33C/34B, 34C	V <sub>BE(on)</sub>	–	2.5	Vdc
Diode Forward Voltage (I <sub>C</sub> = 8.0 Adc)		V <sub>F</sub>	–	4.0	Vdc

1. Pulse Test: Pulse Width ≤ 300 μs, Duty Cycle ≤ 2.0%.
2. Pulse Test non repetitive: Pulse Width = 0.25 seconds.

# BDX33B, BDX33C (NPN) BDX34B, BDX34C (PNP)

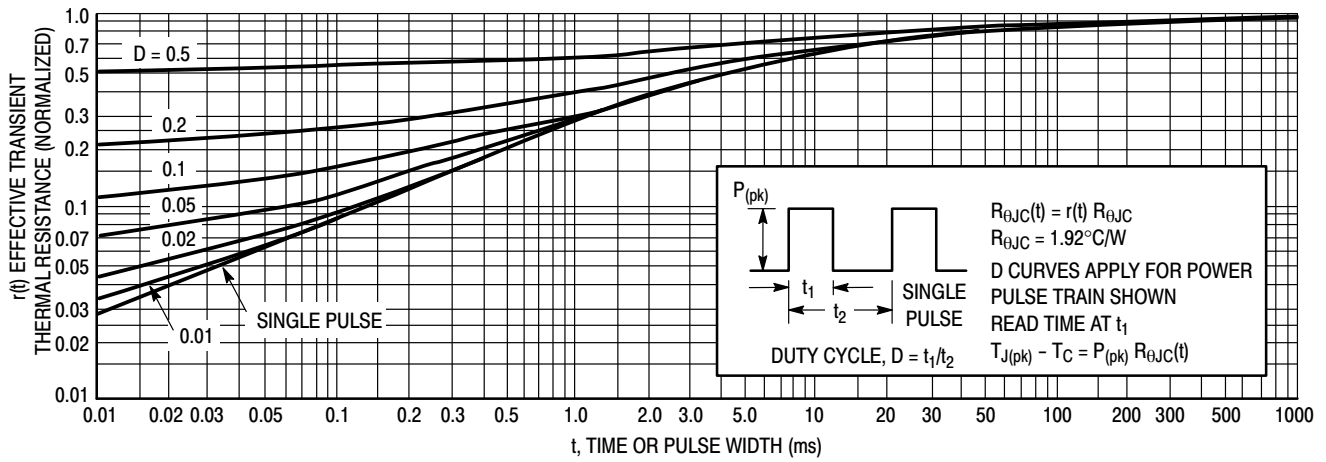

Figure 1. Thermal Response

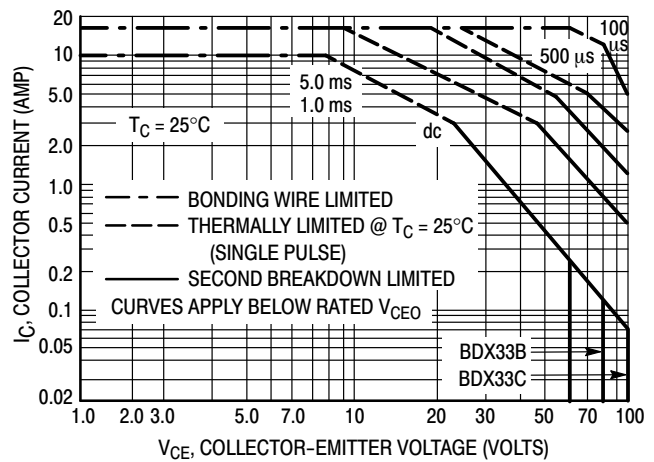
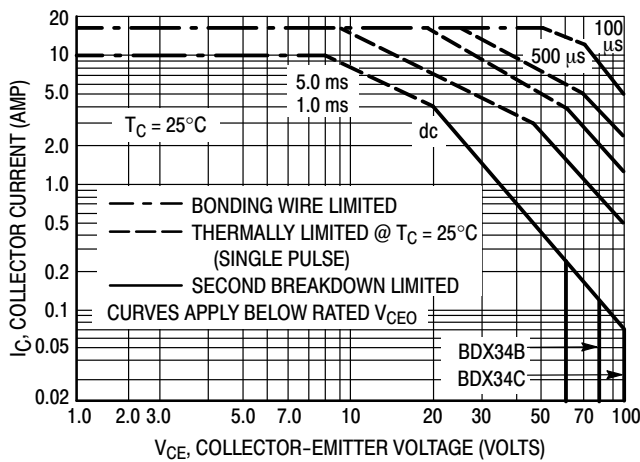

Figure 2. Active-Region Safe Operating Area

There are two limitations on the power handling ability of a transistor: average junction temperature and second breakdown. Safe operating area curves indicate  $I_C - V_{CE}$  limits of the transistor that must be observed for reliable operation, i.e., the transistor must not be subjected to greater dissipation than the curves indicate. The data of Figure 3 is based on  $T_{J(pk)}$

=  $150^\circ\text{C}$ ;  $T_C$  is variable depending on conditions. Second breakdown pulse limits are valid for duty cycles to 10% provided  $T_{J(pk)} = 150^\circ\text{C}$ .  $T_{J(pk)}$  may be calculated from the data in Figure 4. At high case temperatures, thermal limitations will reduce the power that can be handled to values less than the limitations imposed by second breakdown.

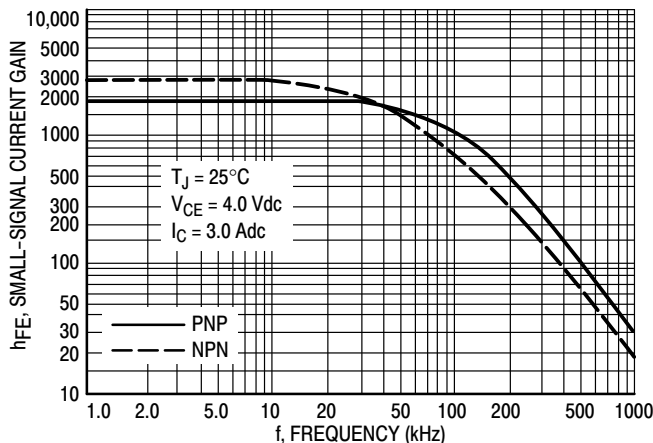

Figure 3. Small-Signal Current Gain

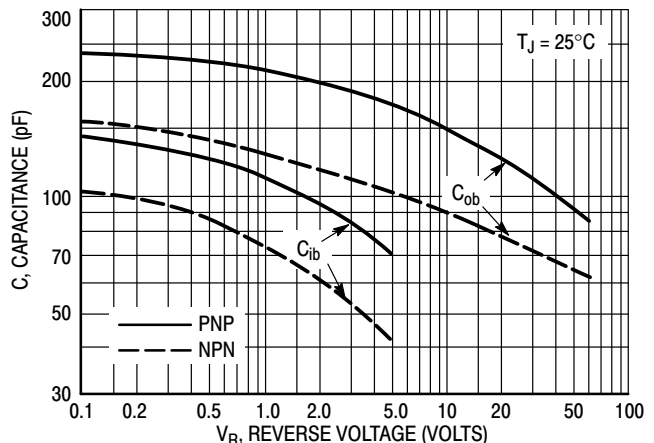
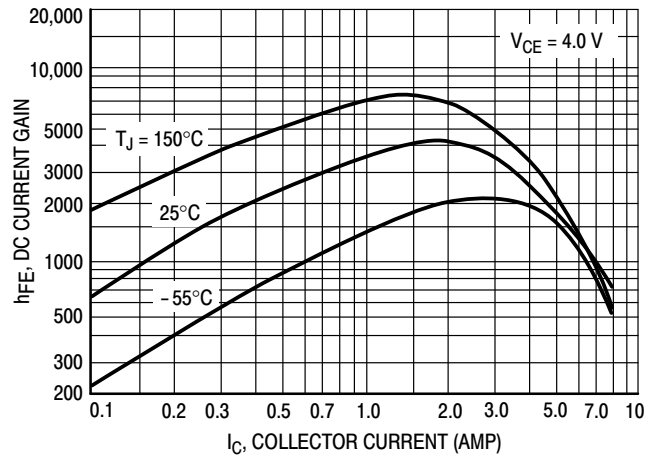
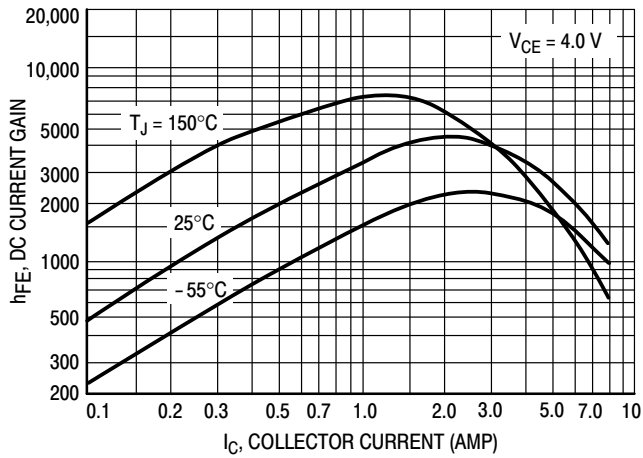

Figure 4. Capacitance

# BDX33B, BDX33C (NPN) BDX34B, BDX34C (PNP)

**NPN**  
**BDX33B, 33C**

**PNP**  
**BDX34B, 34C**



**Figure 5. DC Current Gain**

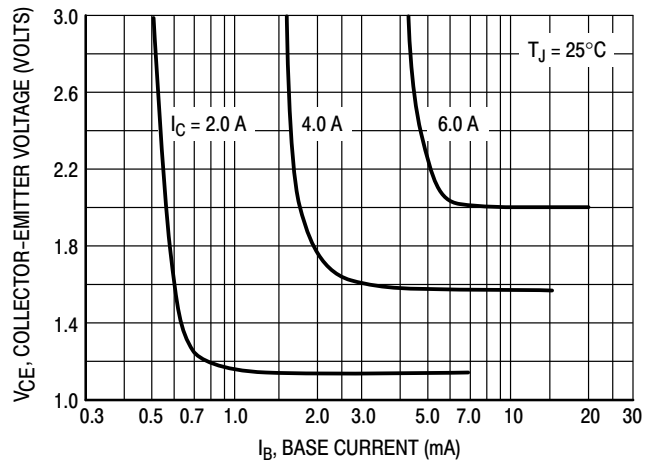
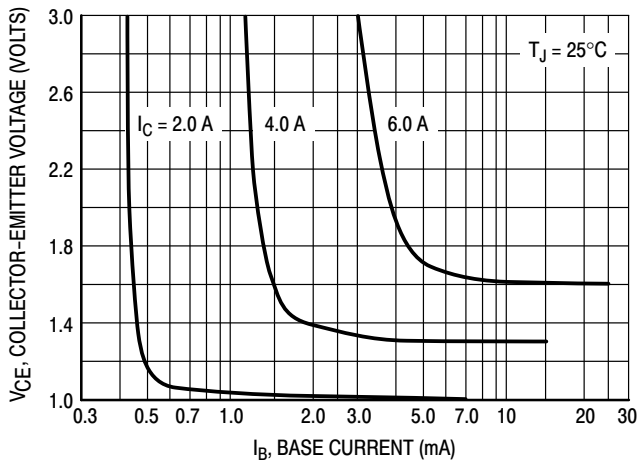

**Figure 6. Collector Saturation Region**

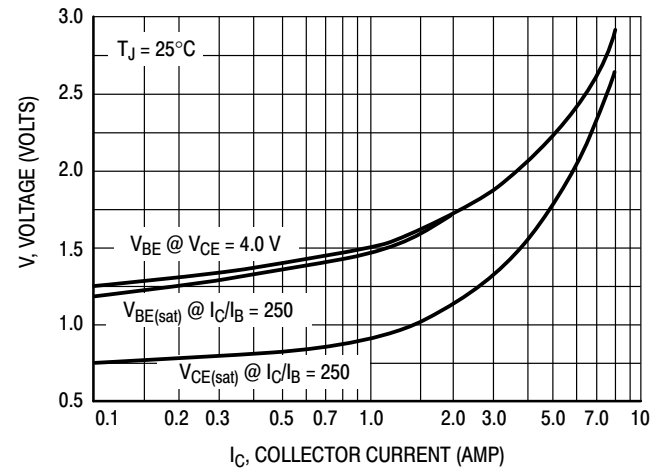
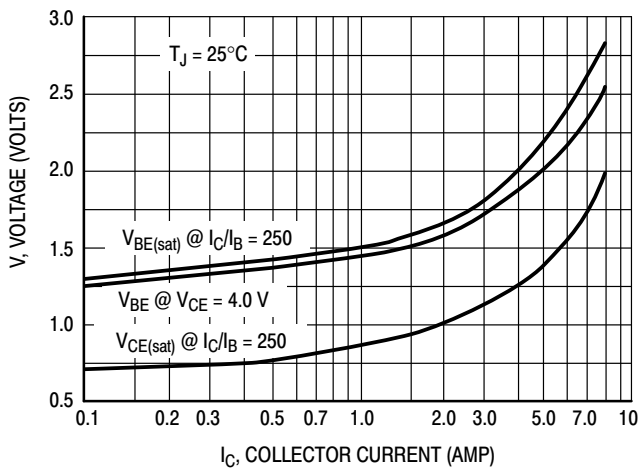

**Figure 7. "On" Voltages**

## BDX33B, BDX33C (NPN) BDX34B, BDX34C (PNP)

### ORDERING INFORMATION

Device	Package	Shipping†
BDX33B	TO-220	50 Units / Rail
BDX33BG	TO-220 (Pb-Free)	
BDX33C	TO-220	50 Units / Rail
BDX33CG	TO-220 (Pb-Free)	
BDX34B	TO-220	50 Units / Rail
BDX34BG	TO-220 (Pb-Free)	
BDX34C	TO-220	50 Units / Rail
BDX34CG	TO-220 (Pb-Free)	

†For information on tape and reel specifications, including part orientation and tape sizes, please refer to our Tape and Reel Packaging Specifications Brochure, BRD8011/D.

# BDX33B, BDX33C (NPN) BDX34B, BDX34C (PNP)

## PACKAGE DIMENSIONS

### TO-220 CASE 221A-09 ISSUE AG

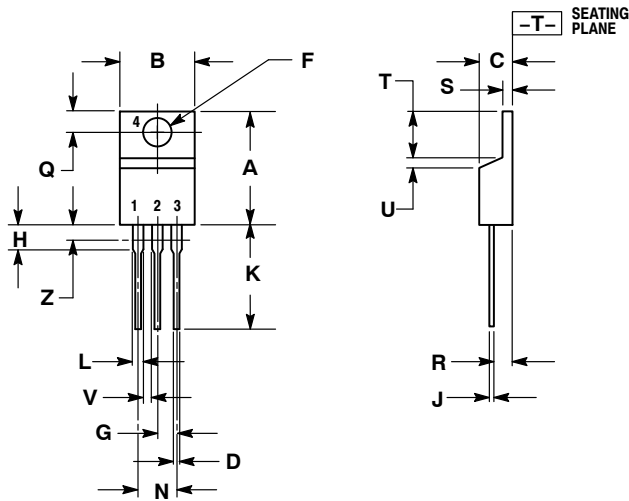

#### NOTES:

1. DIMENSIONING AND TOLERANCING PER ANSI Y14.5M, 1982.
2. CONTROLLING DIMENSION: INCH.
3. DIMENSION Z DEFINES A ZONE WHERE ALL BODY AND LEAD IRREGULARITIES ARE ALLOWED.

DIM	INCHES		MILLIMETERS	
	MIN	MAX	MIN	MAX
A	0.570	0.620	14.48	15.75
B	0.380	0.405	9.66	10.28
C	0.160	0.190	4.07	4.82
D	0.025	0.036	0.64	0.91
F	0.142	0.161	3.61	4.09
G	0.095	0.105	2.42	2.66
H	0.110	0.161	2.80	4.10
J	0.014	0.025	0.36	0.64
K	0.500	0.562	12.70	14.27
L	0.045	0.060	1.15	1.52
N	0.190	0.210	4.83	5.33
Q	0.100	0.120	2.54	3.04
R	0.080	0.110	2.04	2.79
S	0.045	0.055	1.15	1.39
T	0.235	0.255	5.97	6.47
U	0.000	0.050	0.00	1.27
V	0.045	---	1.15	---
Z	---	0.080	---	2.04

#### STYLE 1:

- PIN 1. BASE
- COLLECTOR
- EMITTER
- COLLECTOR

ON Semiconductor and are registered trademarks of Semiconductor Components Industries, LLC (SCILLC). SCILLC reserves the right to make changes without further notice to any products herein. SCILLC makes no warranty, representation or guarantee regarding the suitability of its products for any particular purpose, nor does SCILLC assume any liability arising out of the application or use of any product or circuit, and specifically disclaims any and all liability, including without limitation special, consequential or incidental damages. "Typical" parameters which may be provided in SCILLC data sheets and/or specifications can and do vary in different applications and actual performance may vary over time. All operating parameters, including "Typicals" must be validated for each customer application by customer's technical experts. SCILLC does not convey any license under its patent rights nor the rights of others. SCILLC products are not designed, intended, or authorized for use as components in systems intended for surgical implant into the body, or other applications intended to support or sustain life, or for any other application in which the failure of the SCILLC product could create a situation where personal injury or death may occur. Should Buyer purchase or use SCILLC products for any such unintended or unauthorized application, Buyer shall indemnify and hold SCILLC and its officers, employees, subsidiaries, affiliates, and distributors harmless against all claims, costs, damages, and expenses, and reasonable attorney fees arising out of, directly or indirectly, any claim of personal injury or death associated with such unintended or unauthorized use, even if such claim alleges that SCILLC was negligent regarding the design or manufacture of the part. SCILLC is an Equal Opportunity/Affirmative Action Employer. This literature is subject to all applicable copyright laws and is not for resale in any manner.

### PUBLICATION ORDERING INFORMATION

#### LITERATURE FULFILLMENT:

Literature Distribution Center for ON Semiconductor  
P.O. Box 5163, Denver, Colorado 80217 USA  
Phone: 303-675-2175 or 800-344-3860 Toll Free USA/Canada  
Fax: 303-675-2176 or 800-344-3867 Toll Free USA/Canada  
Email: orderlit@onsemi.com

**N. American Technical Support:** 800-282-9855 Toll Free  
USA/Canada  
**Europe, Middle East and Africa Technical Support:**  
Phone: 421 33 790 2910  
**Japan Customer Focus Center**  
Phone: 81-3-5817-1050

**ON Semiconductor Website:** [www.onsemi.com](http://www.onsemi.com)

**Order Literature:** <http://www.onsemi.com/orderlit>

For additional information, please contact your local Sales Representative

## Данный компонент на территории Российской Федерации

### Вы можете приобрести в компании MosChip.

Для оперативного оформления запроса Вам необходимо перейти по данной ссылке:

<http://moschip.ru/get-element>

Вы можете разместить у нас заказ для любого Вашего проекта, будь то серийное производство или разработка единичного прибора.

В нашем ассортименте представлены ведущие мировые производители активных и пассивных электронных компонентов.

Нашей специализацией является поставка электронной компонентной базы двойного назначения, продукции таких производителей как XILINX, Intel (ex.ALTERA), Vicor, Microchip, Texas Instruments, Analog Devices, Mini-Circuits, Amphenol, Glenair.

Сотрудничество с глобальными дистрибьюторами электронных компонентов, предоставляет возможность заказывать и получать с международных складов практически любой перечень компонентов в оптимальные для Вас сроки.

На всех этапах разработки и производства наши партнеры могут получить квалифицированную поддержку опытных инженеров.

Система менеджмента качества компании отвечает требованиям в соответствии с ГОСТ Р ИСО 9001, ГОСТ РВ 0015-002 и ЭС РД 009

### Офис по работе с юридическими лицами:

105318, г.Москва, ул.Щербаковская д.3, офис 1107, 1118, ДЦ «Щербаковский»

Телефон: +7 495 668-12-70 (многоканальный)

Факс: +7 495 668-12-70 (доб.304)

E-mail: [info@moschip.ru](mailto:info@moschip.ru)

Skype отдела продаж:

moschip.ru

moschip.ru\_4

moschip.ru\_6

moschip.ru\_9