

# EA DIP128-6

## LCD-GRAFIC MODULE 128x64 DOTS

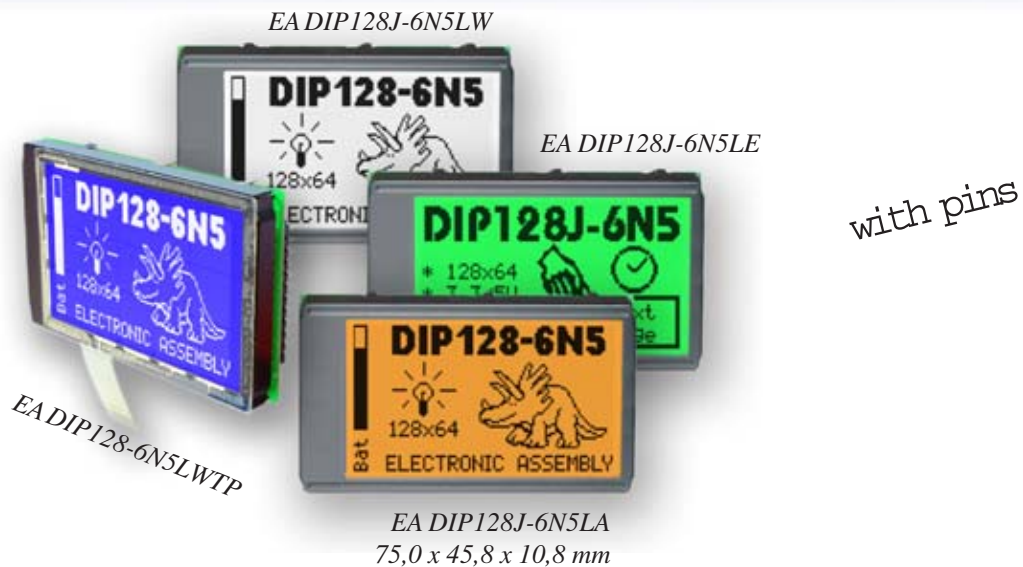

### FEATURES

- \* REAL BRIGHT AND CONTRASTY GRAPHIC DISPLAYS
- \* EA DIP128-6N5LW: WHITE DOTS, BLUE BACKGROUND
- \* EA DIP128J-6N5LW: BLACK DOTS, WHITE BACKGROUND
- \* WITH AMBER BACKLIGHT (LONGLIFE)
- \* GREEN VERSION FOR HIGHEST CONTRAST
- \* LOW-POWER LED BACKLIGHT min. 15mA, max. 90mA@+25°C
- \* INTEGRATED CONTROLLER KS0107/108 OR PT6607/08
- \* TEMPERATURE COMPENSATION BUILT-IN
- \* 8-BIT BUS INTERFACE
- \* NO MOUNTING REQUIRED: JUST SOLDER INTO PCB
- \* POWER SUPPLY +5V
- \* OPERATING TEMPERATURE RANGE -20°C..+70°C

### ACCESSORIES

- \* MATRIX TOUCH PANEL 5x3, ANTIGLARE AND SCRATCH-PROOF
- \* HIGH-LEVEL-GRAPHICS-CONTROLLER FOR RS-232: **EA IC202-PGH**

### ORDERING INFORMATION

LCD GRAPHIC MODULE 128x64 DOTS BLUE-WHITE  
 SAME BUT IN BLACK/WHITE OPTIC  
 WITH AMBER BACKLIGHT  
 WITH GREEN BACKLIGHT  
 ALL WITH TOUCH PANEL, 5x3 FIELDS  
 SOCKET 4.5mm HEIGHT, 12 PINS (1 pc.)  
 ZIFF CONNECTOR (SMD) FOR TOUCH PANEL

**EA DIP128-6N5LW**  
**EA DIP128J-6N5LW**  
**EA DIP128J-6N5LA**  
**EA DIP128J-6N5LE**  
**EA DIP128x-xxxxxTP**  
**EA B254-12**  
**EA WF100-10S**

**ELECTRONIC  
 ASSEMBLY**  
 making things easy

## PINOUT

| Pin | Symbol | Function                         | Pin | Symbol | Function                        |
|-----|--------|----------------------------------|-----|--------|---------------------------------|
| 1   | VSS    | Power Supply 0V (GND)            | 13  | VNEG   | neg. voltage output f. contrast |
| 2   | VDD    | Power Supply +5V                 | 14  | NC     | not connected                   |
| 3   | ADJ    | Contrast adjustment              | 15  | D0     | Display Data, LSB               |
| 4   | RES    | L: Reset                         | 16  | D1     | Display Data                    |
| 5   | D/I    | H=Data; L=Command                | 17  | D2     | Display Data                    |
| 6   | R/W    | H=Read, L=Write                  | 18  | D3     | Display Data                    |
| 7   | E1     | Enable left half of display      | 19  | D4     | Display Data                    |
| 8   | E2     | Enable right half of display     | 20  | D5     | Display Data                    |
| 9   | CS1L   | L: Chipselect left, low active   | 21  | D6     | Display Data                    |
| 10  | CS1H   | H: Chipselect left, high active  | 22  | D7     | Display Data, MSB               |
| 11  | CS2L   | L: Chipselect right, low active  | 23  | A      | LED + (ext. series resistor !)  |
| 12  | CS2H   | H: Chipselect right, high active | 24  | C      | LED -                           |

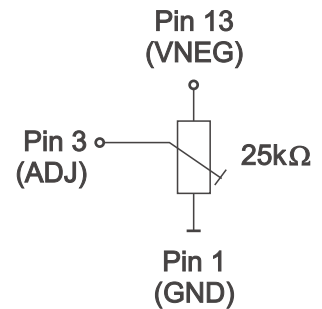

## CONTRAST

is already adjusted for 5V when shipped out. Once contrast is set to an optimum, internal temperature compensation circuit provides best contrast allover the whole temperature range of -20..+70°C. An external contrast adjustment is normally not necessary, but can be done via external potentiometer.

## BACKLIGHT

Graphic displays EA DIP128-6 are featured with a low-power LED-backlight. Brightness can be switched off and adjusted infinitely.

Driving the LED backlight requires a current source or an external series resistor for current limiting. Forward voltage is between 2.2..2.6V (amber), 3.9..3.6V (white), 3.7..4.1V (green). Maximum supply current is 90mA@+25°C. Operating with 5V we recommend a limiting resistor for amber of 12 Ohm, for the white one of 24 Ohm and for the green one of 15 Ohm. Please take care of derating when used at  $t_a > +25^\circ\text{C}$ .

**Attention:** Do never drive backlight direct to 5V; this may cause immediately defect !

**Note:** Blue-white version provide no contrast when backlight is switched off. Reading the display requires a minimum of backlight with about 15mA.

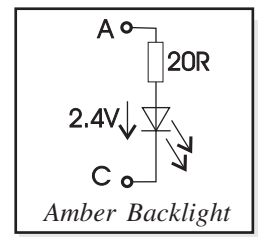

## BLACK&WHITE, BLUE, AMBER, GREEN

The blue-white display EA DIP128-6N5LW is best for indoor use with and without ambient light. Reading the display requires a minimum of backlight with about 15mA.

Black and white version EA DIP128J-6N5LW and green version are especially designed for outdoor applications. These displays do provide best contrast for all ambient illuminations, even with direct sunlight. No need to say that display can be read in darkness when LED backlight is switched on.

This is same for the amber backlighted version EA DIP128J-6N5LA. The greatest advantage here is the long life backlight.

## APPLICATION EXAMPLES

Besides you can see some application examples.

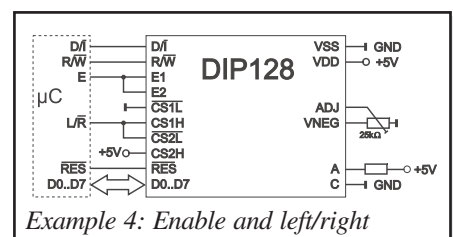
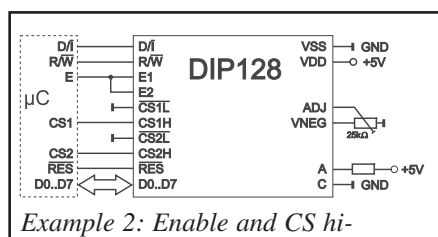
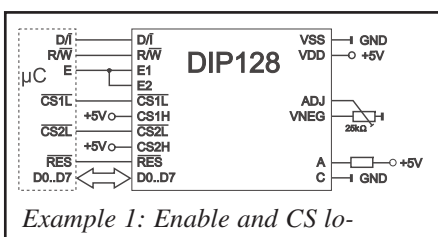
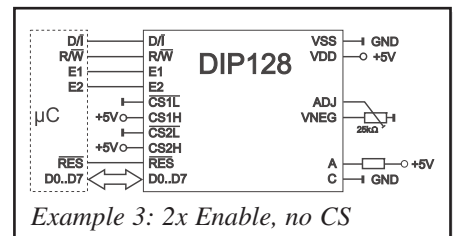

**BLOCK DIAGRAM**



**ABSOLUTE MAXIMUM RATING**

| Parameter              | Symbol  | Min | Max | Unit |
|------------------------|---------|-----|-----|------|
| Power supply for logic | VDD-VSS | 0   | 7,0 | V    |
| Input voltage          | VI      | VSS | VDD | V    |
| Operating temperature  | Ta      | -20 | +70 | °C   |
| Storage temperature    | Tstg    | -30 | +80 | °C   |

**TIMING CHARACTERISTICS** (T<sub>a</sub> = -20..+70°C)

| Parameter              | Symbol | Min  | Typ | Max | Unit |
|------------------------|--------|------|-----|-----|------|
| Enable cycle time      | tcyc   | 1000 | -   | -   | ns   |
| Enable Puls width      | tWEH   | 450  | -   | -   | ns   |
|                        | tWEL   | 450  | -   | -   | ns   |
| Enable raise time      | tEr    | -    | -   | 25  | ns   |
| Enable fall time       | tEf    | -    | -   | 25  | ns   |
| Set-up time            | tAS    | 140  | -   | -   | ns   |
| Data set-up time       | tDSW   | 200  | -   | -   | ns   |
| Data delay time        | tDDR   | -    | -   | 320 | ns   |
| Address hold time      | tAH    | 10   | -   | -   | ns   |
| Data hold time (Write) | tDHW   | 10   | -   | -   | ns   |
| Data hold time (Read)  | tDHR   | 20   | -   | -   | ns   |



**INSTRUCTION SET KS0108/PT6608**

| Instructions        | Code |     |                  |    |                             |    |    |              |    | Function  |  |                          |
|---------------------|------|-----|------------------|----|-----------------------------|----|----|--------------|----|---|--|--------------------------|
|                     | R/W  | D/I | D7               | D6 | D5                          | D4 | D3 | D2           | D1 |   | D0   |                          |
| Display ON/OFF      | 0    | 0   | 0                | 0  | 1                           | 1  | 1  | 1            | 1  | 1/0   | Controls the ON/OFF of display. RAM data and internal status are not affected. 1:ON, 0:OFF |                          |
| Display start line  | 0    | 0   | 1                | 1  | display start line (0 - 63) |    |    |              |    |   | Specifies a RAM line displayed at the top of screen  |                          |
| Set page(X address) | 0    | 0   | 1                | 0  | 1                           | 1  | 1  | Page (0 - 7) |    |   | Sets the page (x address) of RAM at the page of (x address) register.                      |                          |
| Set address         | 0    | 0   | 0                | 1  | Y address (0 - 63)          |    |    |              |    |   | Sets the Y address at the Y address counter  |                          |
| Status Read         | 1    | 0   | B<br>U<br>S<br>Y | 0  | ON                          | R  | 0  | 0            | 0  | 0   | Read the status.   |                          |
|                     |      |     |                  |    | /                           | E  |    |              |    | RESET   | 1:reset<br>1:display OFF   | 0:normal<br>2:display ON |
|                     |      |     |                  |    | OF                          | S  |    |              |    | BUSY  | 1:on the internal operation  | 0:Ready                  |
| Write display data  | 0    | 1   | Write data       |    |                             |    |    |              |    | Writes data D0 to D7 on the data bus into display RAM.    | After access, Y address is increased by 1.   |                          |
| Read display data   | 1    | 1   | Read data        |    |                             |    |    |              |    | Reads data D0 to D7 from the display RAM to the data bus. |  |                          |

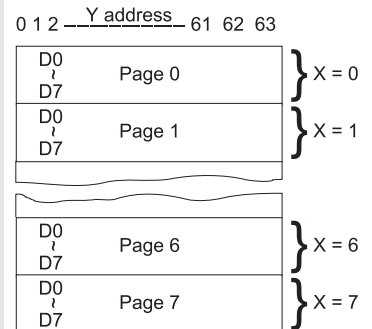

Address Configuration of Display Data RAM

A complete user manual for these on-board controller you'll find at our web site at "user manual" or direct accessed via: <http://www.lcd-module.de/eng/pdf/zubehoer/ks0108b.pdf> and [./pt6608.pdf](http://www.lcd-module.de/eng/pdf/zubehoer/pt6608.pdf)

# EA DIP128-6

Seite 4

## DIMENSIONS



*Hint:*  
LC-Displays are generally not suggested for wave soldering or reflow soldering. Temperatures above 90°C may damage the display immediately.

## TOUCH PANEL

Surface of touch panel is anti-glare and scratch-proof.

Technology: resistive Matrix Touch with 5x3 fixed fields. Readout will be done like for membrane key-switches: scan for columns and rows.

| Electrical Characteristics |           |     |        |        |
|----------------------------|-----------|-----|--------|--------|
| Specification              | min       | typ | max    | Unit   |
| On-Resistance              | 300       |     | 10,000 | Ω      |
| Voltage                    | 0.5       |     | 5      | V      |
| Current                    | 10u       |     | 10m    | A      |
| Contact Force              | 150       |     | 200    | g      |
| Contact Bounce             |           | 10  |        | ms     |
| Temperature range          | -30       |     | +75    | °C     |
| Lifetime                   | 1,000,000 |     |        | cycles |

| Touch Panel |          |
|-------------|----------|
| Pin         | Function |
| 1           | Column 1 |
| 2           | Row 1    |
| 3           | Row 2    |
| 4           | Row 3    |
| 5           | N.C.     |
| 6           | N.C.     |
| 7           | Column 2 |
| 8           | Column 3 |
| 9           | Column 4 |
| 10          | Column 5 |

## EA WF100-10S

ZIF connector for the touch panel as an accessory.

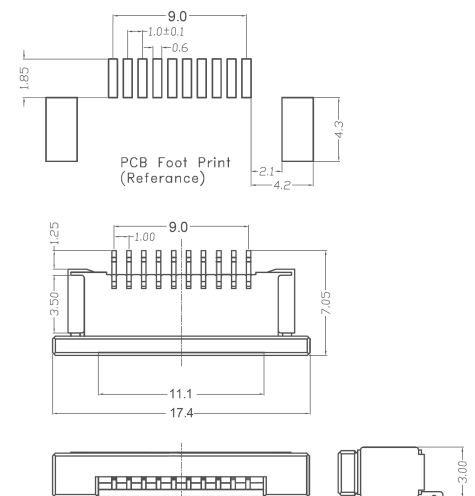

**ELECTRONIC ASSEMBLY**  
making things easy

## Данный компонент на территории Российской Федерации

### Вы можете приобрести в компании MosChip.

Для оперативного оформления запроса Вам необходимо перейти по данной ссылке:

<http://moschip.ru/get-element>

Вы можете разместить у нас заказ для любого Вашего проекта, будь то серийное производство или разработка единичного прибора.

В нашем ассортименте представлены ведущие мировые производители активных и пассивных электронных компонентов.

Нашей специализацией является поставка электронной компонентной базы двойного назначения, продукции таких производителей как XILINX, Intel (ex.ALTERA), Vicor, Microchip, Texas Instruments, Analog Devices, Mini-Circuits, Amphenol, Glenair.

Сотрудничество с глобальными дистрибьюторами электронных компонентов, предоставляет возможность заказывать и получать с международных складов практически любой перечень компонентов в оптимальные для Вас сроки.

На всех этапах разработки и производства наши партнеры могут получить квалифицированную поддержку опытных инженеров.

Система менеджмента качества компании отвечает требованиям в соответствии с ГОСТ Р ИСО 9001, ГОСТ РВ 0015-002 и ЭС РД 009

### Офис по работе с юридическими лицами:

105318, г.Москва, ул.Щербаковская д.3, офис 1107, 1118, ДЦ «Щербаковский»

Телефон: +7 495 668-12-70 (многоканальный)

Факс: +7 495 668-12-70 (доб.304)

E-mail: [info@moschip.ru](mailto:info@moschip.ru)

Skype отдела продаж:

moschip.ru

moschip.ru\_4

moschip.ru\_6

moschip.ru\_9