

V_{CES}	650V
$I_C(100^\circ\text{C})$	8A
$V_{CE(sat)}$ (Typ.)	1.65V
P_D	94W

●Features

- 1) Low Collector - Emitter Saturation Voltage
- 2) Low Switching Loss
- 3) Short Circuit Withstand Time 5 μ s
- 4) Built in Very Fast & Soft Recovery FRD (RFN - Series)
- 5) Pb - free Lead Plating ; RoHS Compliant

●Applications

General Inverter
UPS
Power Conditioner
Welder

●Outline

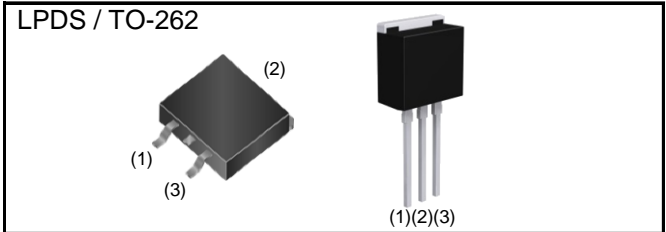

●Inner Circuit

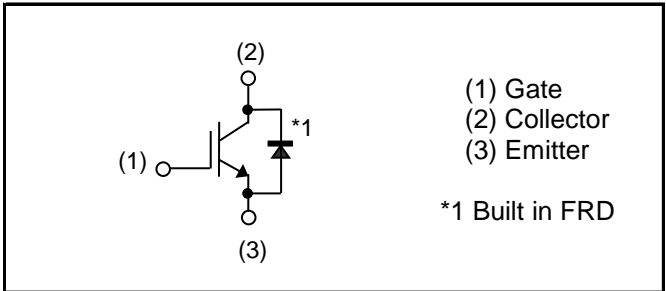

●Packaging Specifications

Type	Packaging	Taping / Tube
	Reel Size (mm)	330 / -
	Tape Width (mm)	24 / -
	Basic Ordering Unit (pcs)	1,000 / 1,000
	Packing code	TL / C9
	Marking	RGT16NS65D

●Absolute Maximum Ratings (at $T_C = 25^\circ\text{C}$ unless otherwise specified)

Parameter	Symbol	Value	Unit	
Collector - Emitter Voltage	V_{CES}	650	V	
Gate - Emitter Voltage	V_{GES}	± 30	V	
Collector Current	$T_C = 25^\circ\text{C}$	I_C	16	A
	$T_C = 100^\circ\text{C}$	I_C	8	A
Pulsed Collector Current	I_{CP}^{*1}	24	A	
Diode Forward Current	$T_C = 25^\circ\text{C}$	I_F	16	A
	$T_C = 100^\circ\text{C}$	I_F	8	A
Diode Pulsed Forward Current	I_{FP}^{*1}	24	A	
Power Dissipation	$T_C = 25^\circ\text{C}$	P_D	94	W
	$T_C = 100^\circ\text{C}$	P_D	47	W
Operating Junction Temperature	T_j	-40 to +175	$^\circ\text{C}$	
Storage Temperature	T_{stg}	-55 to +175	$^\circ\text{C}$	

*1 Pulse width limited by T_{jmax} .

● Thermal Resistance

Parameter	Symbol	Values			Unit
		Min.	Typ.	Max.	
Thermal Resistance IGBT Junction - Case	$R_{\theta(j-c)}$	-	-	1.58	°C/W
Thermal Resistance Diode Junction - Case	$R_{\theta(j-c)}$	-	-	3.60	°C/W

● IGBT Electrical Characteristics (at $T_j = 25^\circ\text{C}$ unless otherwise specified)

Parameter	Symbol	Conditions	Values			Unit
			Min.	Typ.	Max.	
Collector - Emitter Breakdown Voltage	BV_{CES}	$I_C = 10\mu\text{A}$, $V_{GE} = 0\text{V}$	650	-	-	V
Collector Cut - off Current	I_{CES}	$V_{CE} = 650\text{V}$, $V_{GE} = 0\text{V}$	-	-	10	μA
Gate - Emitter Leakage Current	I_{GES}	$V_{GE} = \pm 30\text{V}$, $V_{CE} = 0\text{V}$	-	-	± 200	nA
Gate - Emitter Threshold Voltage	$V_{GE(th)}$	$V_{CE} = 5\text{V}$, $I_C = 5.5\text{mA}$	5.0	6.0	7.0	V
Collector - Emitter Saturation Voltage	$V_{CE(sat)}$	$I_C = 8\text{A}$, $V_{GE} = 15\text{V}$	-	1.65	2.1	V
		$T_j = 25^\circ\text{C}$	-	2.15	-	
		$T_j = 175^\circ\text{C}$	-			

●IGBT Electrical Characteristics (at $T_j = 25^\circ\text{C}$ unless otherwise specified)

Parameter	Symbol	Conditions	Values			Unit
			Min.	Typ.	Max.	
Input Capacitance	C_{ies}	$V_{CE} = 30\text{V}$	-	450	-	pF
Output Capacitance	C_{oes}	$V_{GE} = 0\text{V}$	-	21	-	
Reverse Transfer Capacitance	C_{res}	$f = 1\text{MHz}$	-	8	-	
Total Gate Charge	Q_g	$V_{CE} = 300\text{V}$	-	21	-	nC
Gate - Emitter Charge	Q_{ge}	$I_C = 8\text{A}$	-	6	-	
Gate - Collector Charge	Q_{gc}	$V_{GE} = 15\text{V}$	-	8	-	
Turn - on Delay Time	$t_{d(on)}$	$I_C = 8\text{A}, V_{CC} = 400\text{V}$	-	13	-	ns
Rise Time	t_r	$V_{GE} = 15\text{V}, R_G = 10\Omega$	-	13	-	
Turn - off Delay Time	$t_{d(off)}$	$T_j = 25^\circ\text{C}$	-	33	-	
Fall Time	t_f	Inductive Load	-	95	-	
Turn - on Delay Time	$t_{d(on)}$	$I_C = 8\text{A}, V_{CC} = 400\text{V}$	-	13	-	ns
Rise Time	t_r	$V_{GE} = 15\text{V}, R_G = 10\Omega$	-	14	-	
Turn - off Delay Time	$t_{d(off)}$	$T_j = 175^\circ\text{C}$	-	50	-	
Fall Time	t_f	Inductive Load	-	120	-	
Reverse Bias Safe Operating Area	RBSOA	$I_C = 24\text{A}, V_{CC} = 520\text{V}$ $V_P = 650\text{V}, V_{GE} = 15\text{V}$ $R_G = 50\Omega, T_j = 175^\circ\text{C}$	FULL SQUARE			-
Short Circuit Withstand Time	t_{sc}	$V_{CC} \leq 360\text{V}$ $V_{GE} = 15\text{V}$ $T_j = 25^\circ\text{C}$	5	-	-	μs

●FRD Electrical Characteristics (at $T_j = 25^\circ\text{C}$ unless otherwise specified)

Parameter	Symbol	Conditions	Values			Unit
			Min.	Typ.	Max.	
Diode Forward Voltage	V_F	$I_F = 8\text{A}$	-	1.4	1.9	V
		$T_j = 25^\circ\text{C}$	-	1.4	-	
Diode Reverse Recovery Time	t_{rr}	$I_F = 8\text{A}$	-	42	-	ns
Diode Peak Reverse Recovery Current	I_{rr}	$V_{CC} = 400\text{V}$ $di_F/dt = 200\text{A}/\mu\text{s}$	-	5.2	-	A
Diode Reverse Recovery Charge	Q_{rr}	$T_j = 25^\circ\text{C}$	-	0.12	-	μC
Diode Reverse Recovery Time	t_{rr}	$I_F = 8\text{A}$	-	116	-	ns
Diode Peak Reverse Recovery Current	I_{rr}	$V_{CC} = 400\text{V}$ $di_F/dt = 200\text{A}/\mu\text{s}$	-	8.1	-	A
Diode Reverse Recovery Charge	Q_{rr}	$T_j = 175^\circ\text{C}$	-	0.51	-	μC

●Electrical Characteristic Curves

Fig.1 Power Dissipation vs. Case Temperature

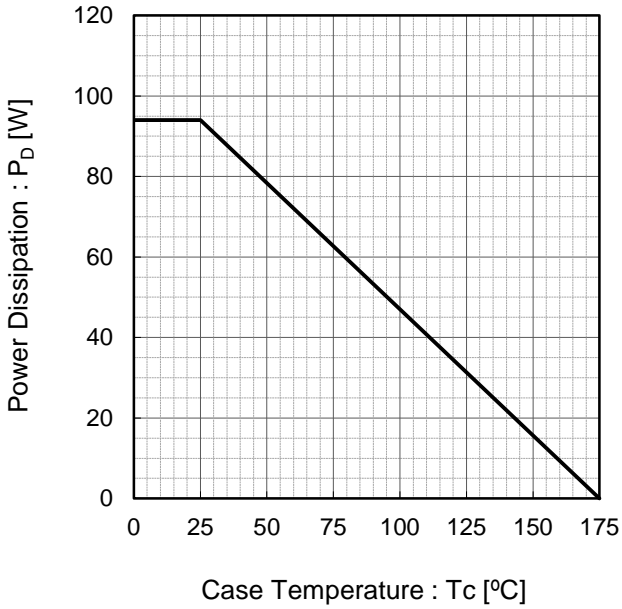

Fig.2 Collector Current vs. Case Temperature

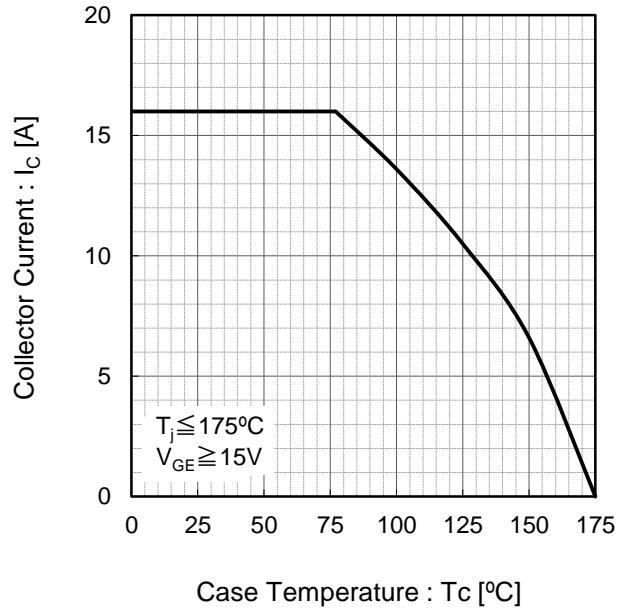

Fig.3 Forward Bias Safe Operating Area

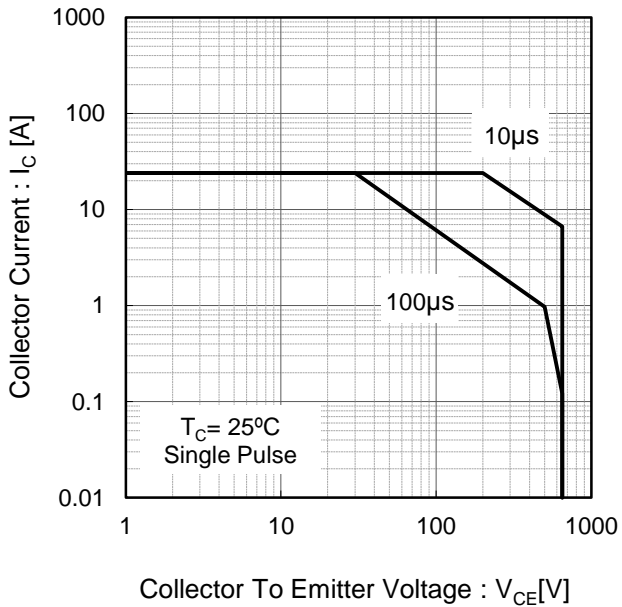
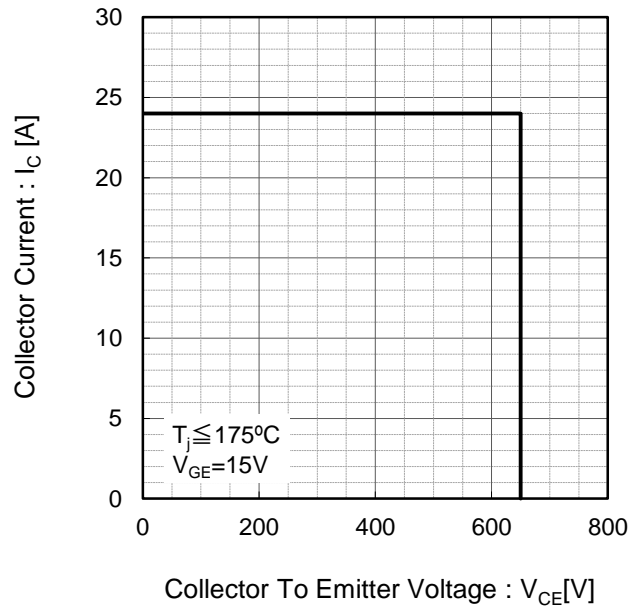

Fig.4 Reverse Bias Safe Operating Area



●Electrical Characteristic Curves

Fig.5 Typical Output Characteristics

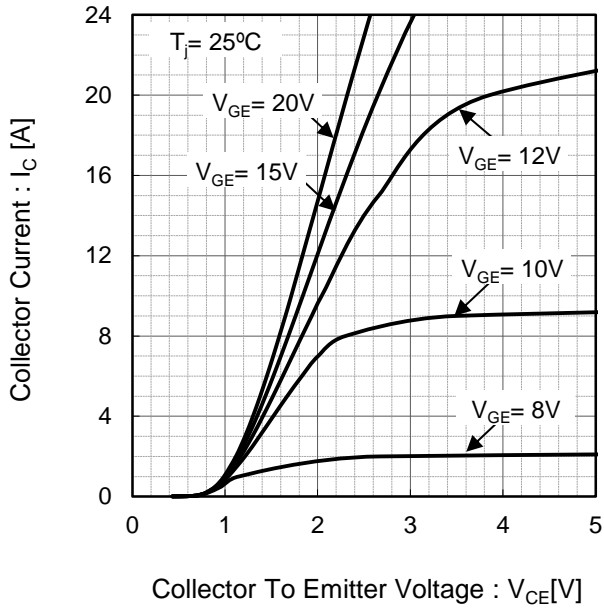

Fig.6 Typical Output Characteristics

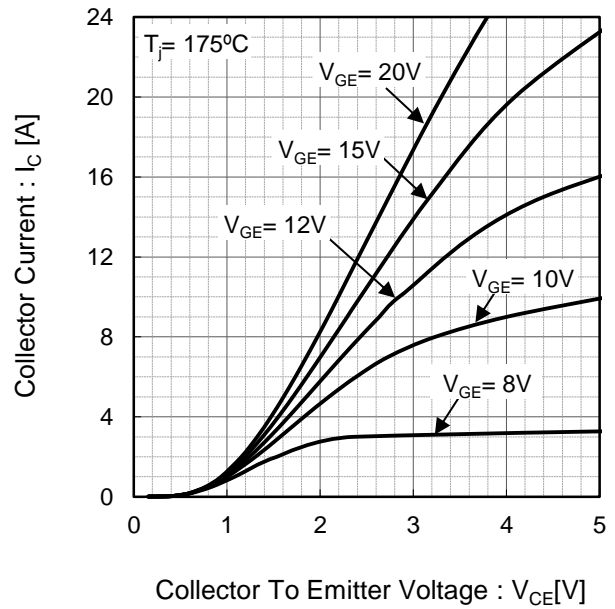

Fig.7 Typical Transfer Characteristics

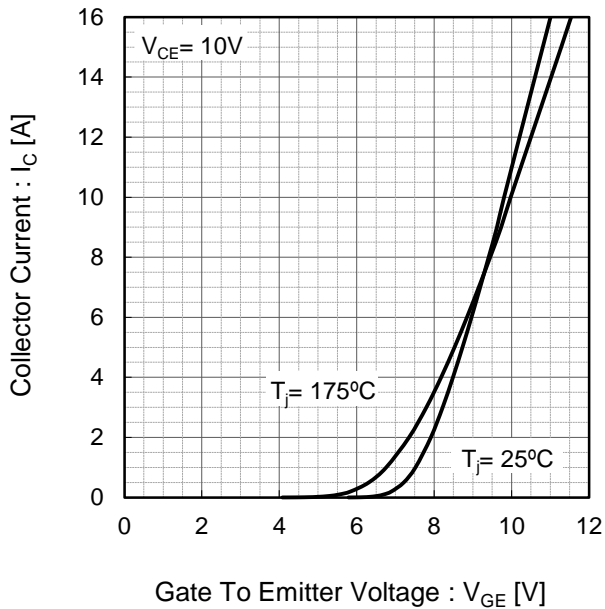
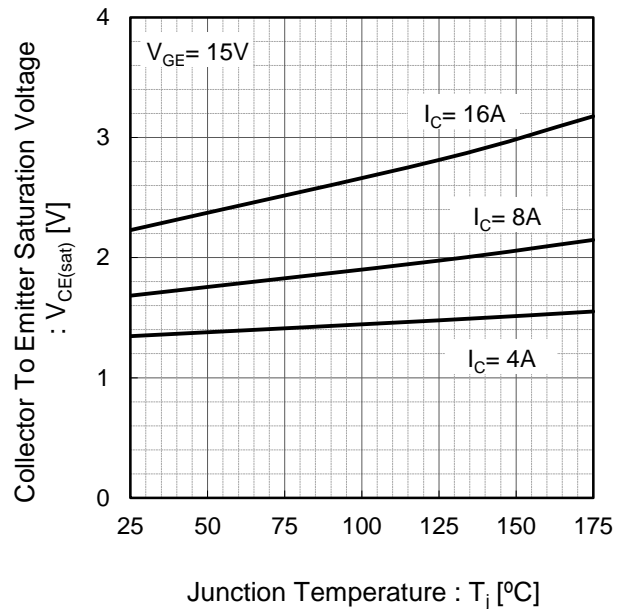

Fig.8 Typical Collector To Emitter Saturation Voltage vs. Junction Temperature



●Electrical Characteristic Curves

Fig.9 Typical Collector To Emitter Saturation Voltage vs. Gate To Emitter Voltage

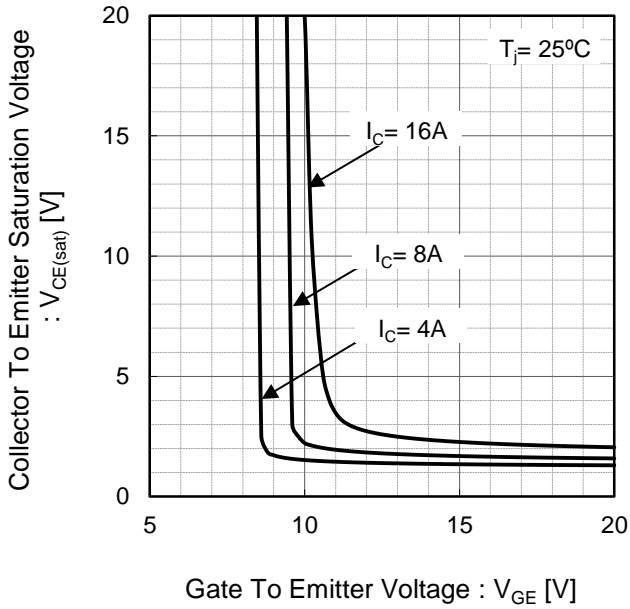

Fig.10 Typical Collector To Emitter Saturation Voltage vs. Gate To Emitter Voltage

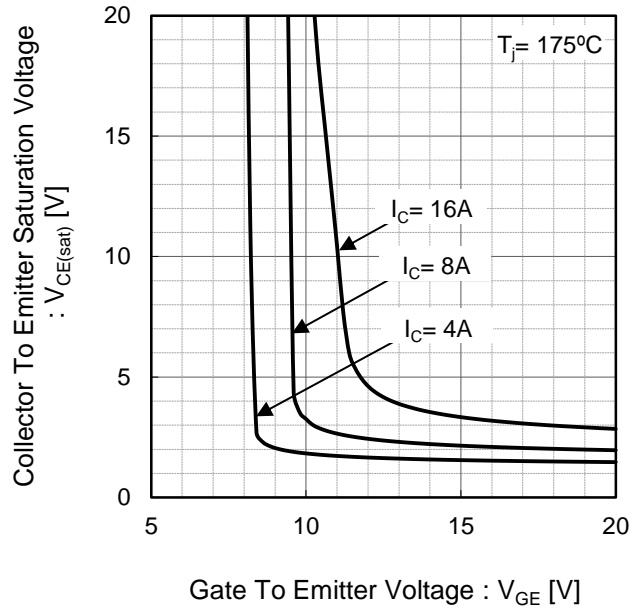

Fig.11 Typical Switching Time vs. Collector Current

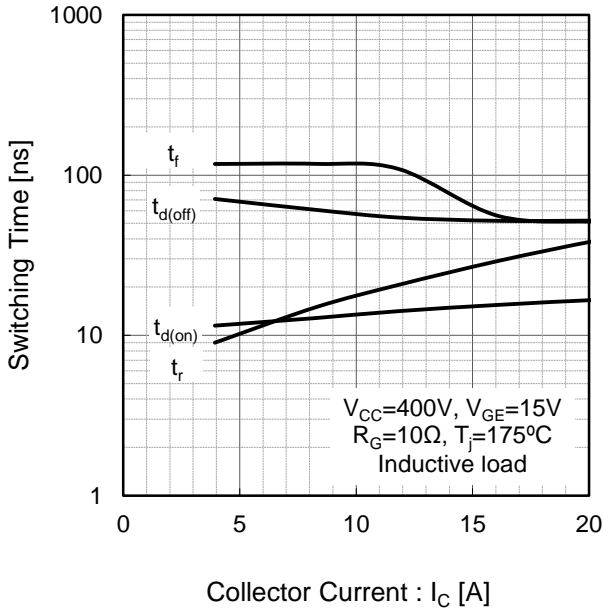
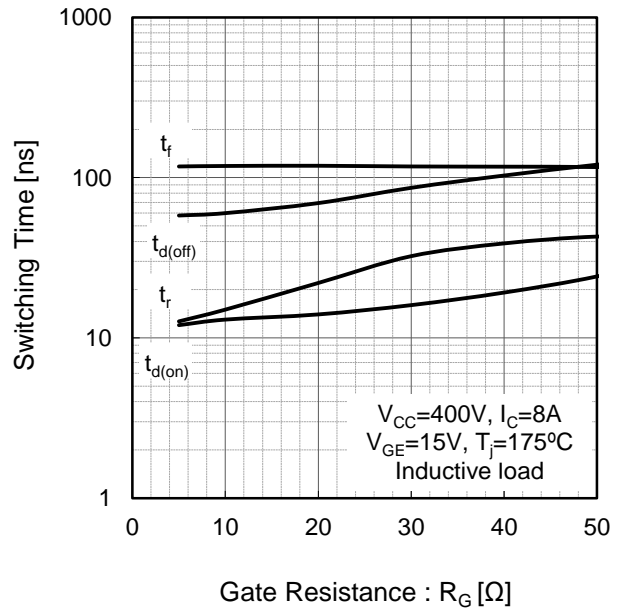

Fig.12 Typical Switching Time vs. Gate Resistance



●Electrical Characteristic Curves

Fig.13 Typical Switching Energy Losses vs. Collector Current

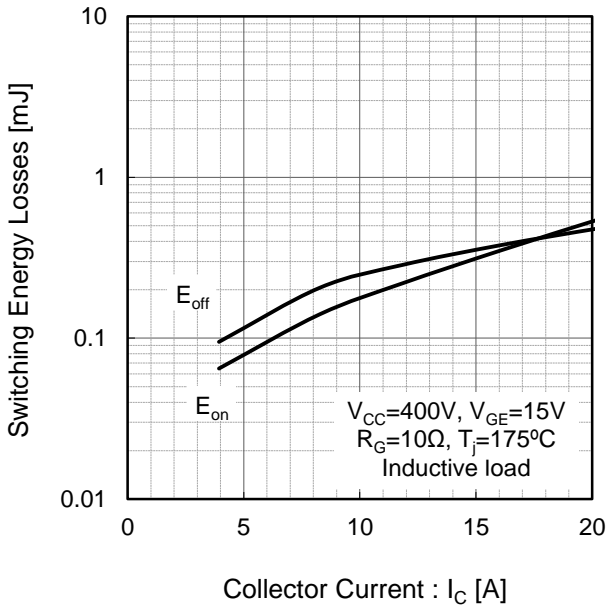

Fig.14 Typical Switching Energy Losses vs. Gate Resistance

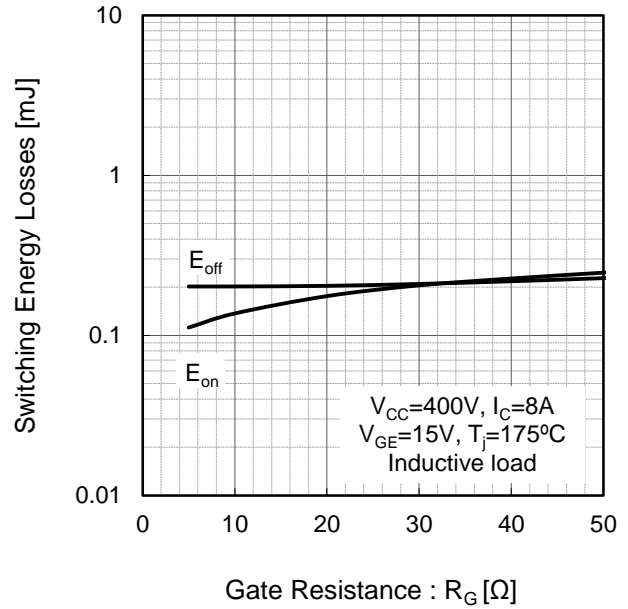

Fig.15 Typical Capacitance vs. Collector To Emitter Voltage

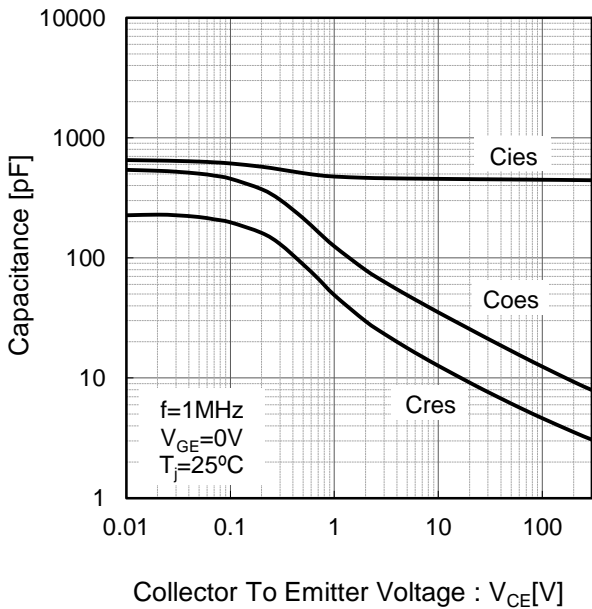
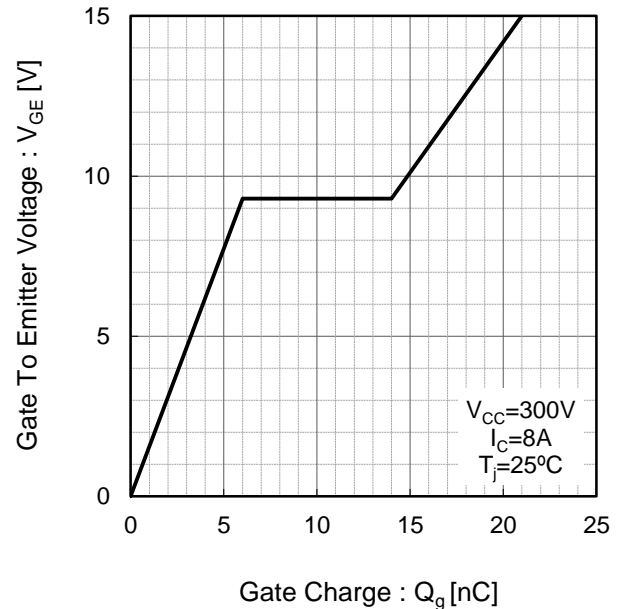

Fig.16 Typical Gate Charge



●Electrical Characteristic Curves

Fig.17 Typical Diode Forward Current vs. Forward Voltage

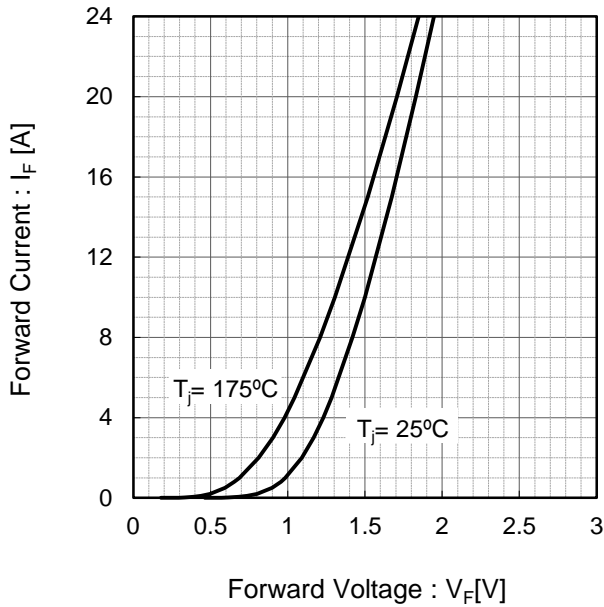

Fig.18 Typical Diode Reverse Recovery Time vs. Forward Current

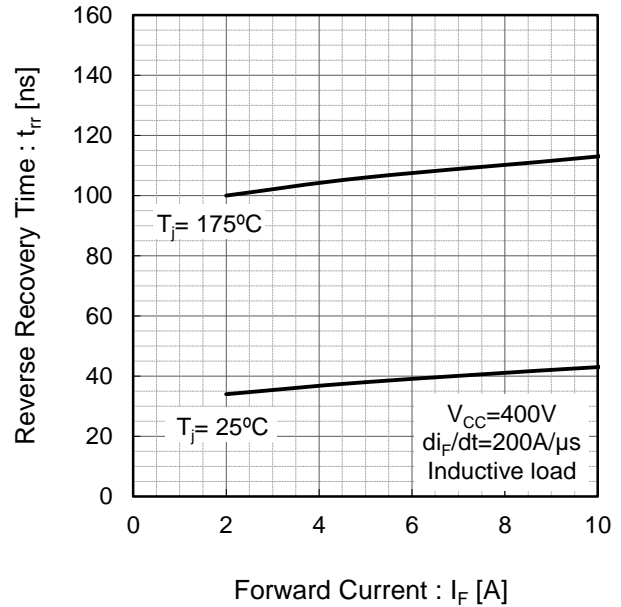

Fig.19 Typical Diode Reverse Recovery Current vs. Forward Current

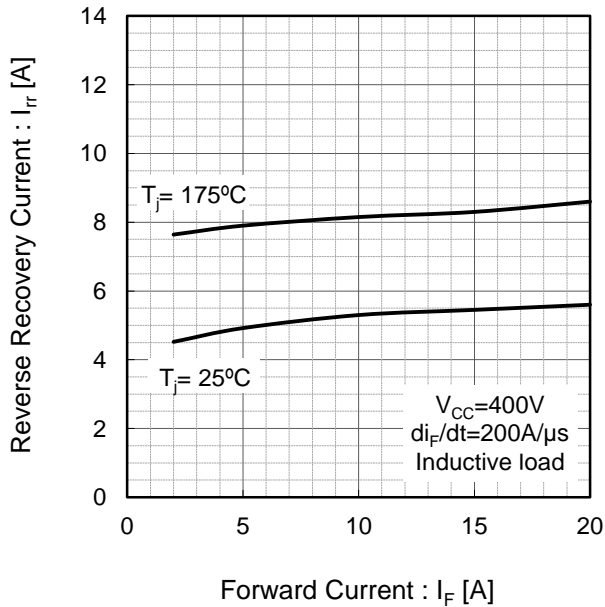
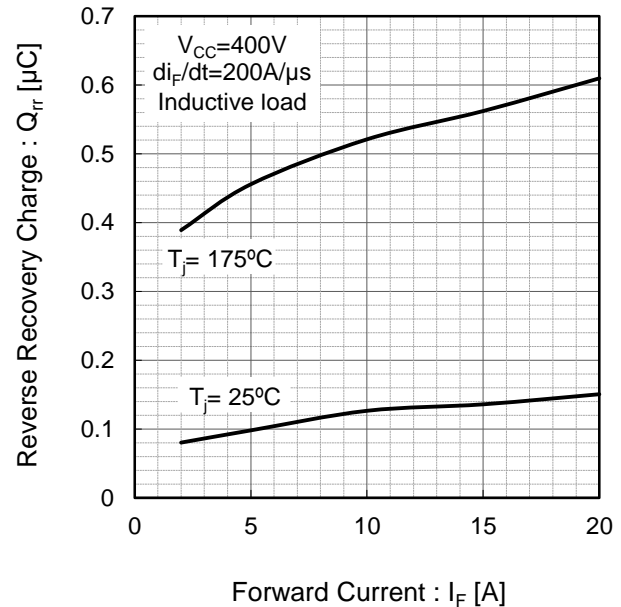

Fig.20 Typical Diode Reverse Recovery Charge vs. Forward Current



●Electrical Characteristic Curves

Fig.21 IGBT Transient Thermal Impedance

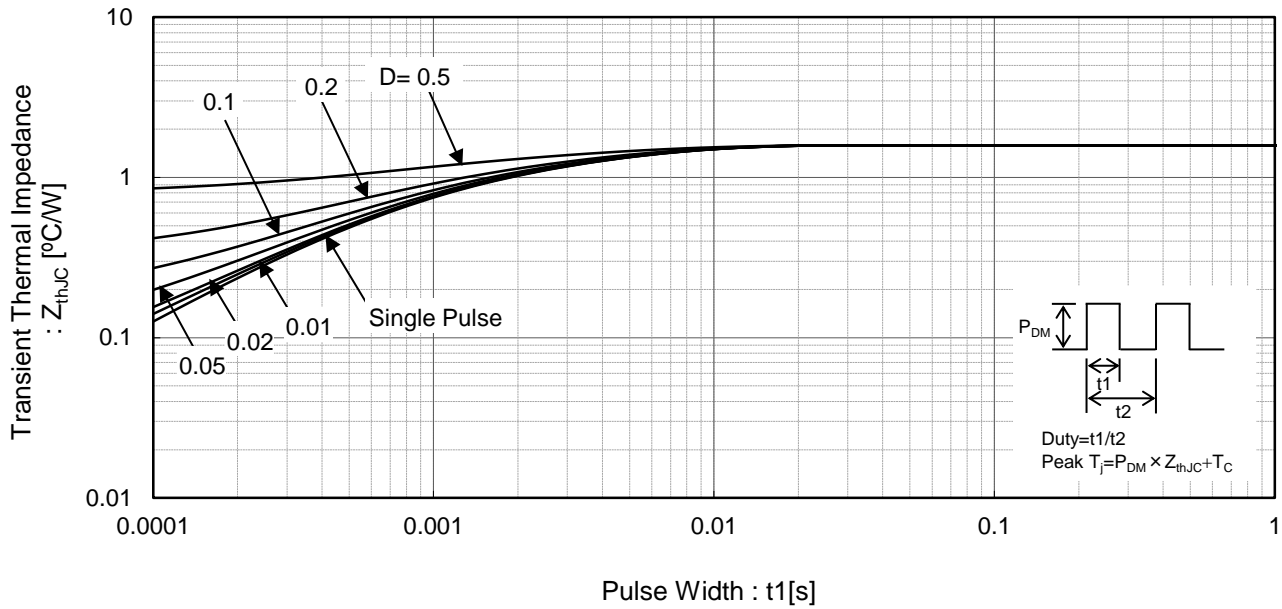
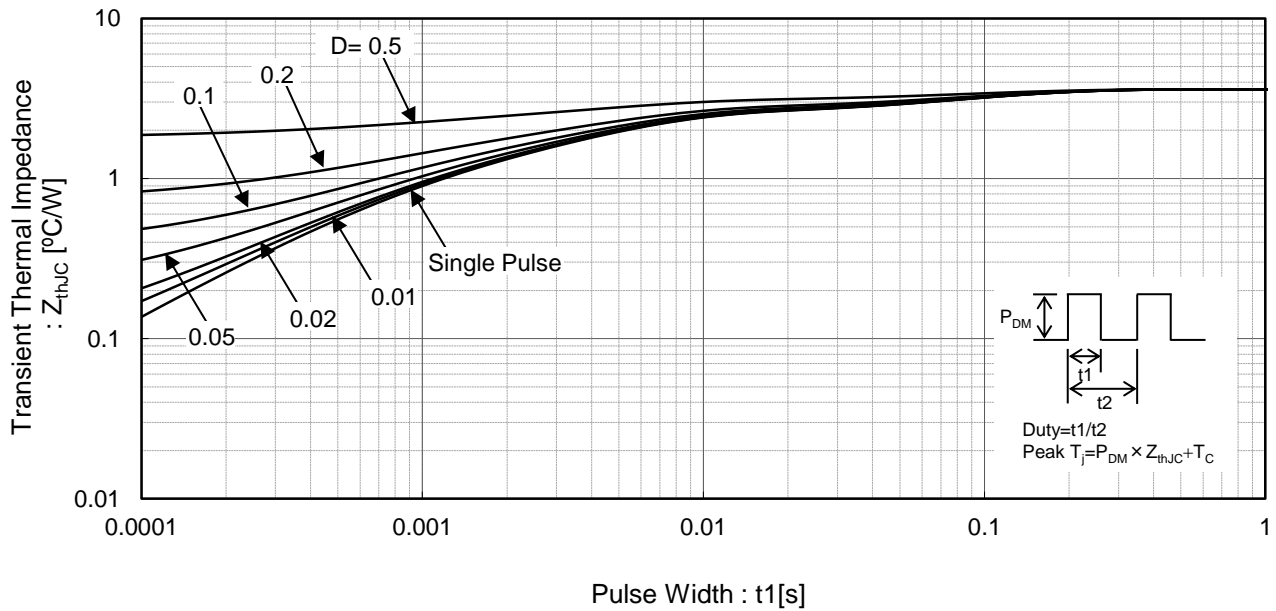

Fig.22 Diode Transient Thermal Impedance



● Inductive Load Switching Circuit and Waveform

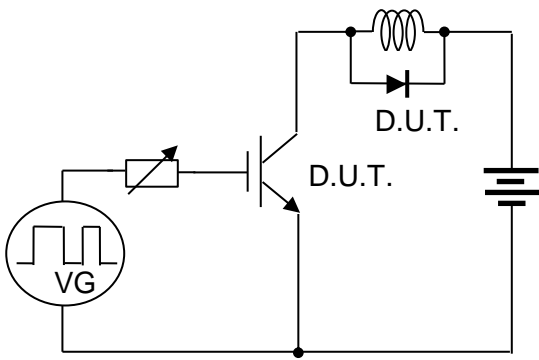

Fig.23 Inductive Load Circuit

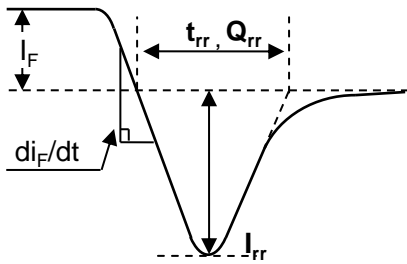

Fig.25 Diode Reverse Recovery Waveform

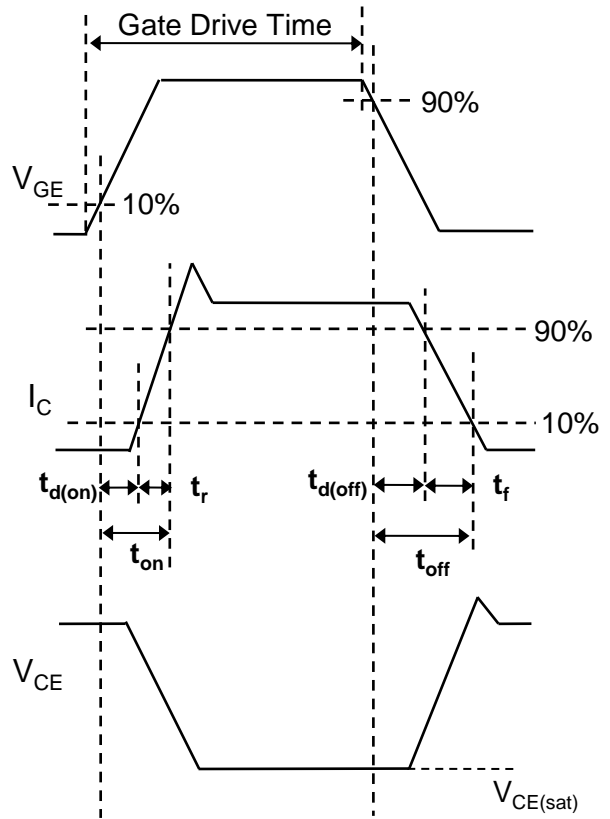

Fig.24 Inductive Load Waveform

Notes

- 1) The information contained herein is subject to change without notice.
- 2) Before you use our Products, please contact our sales representative and verify the latest specifications :
- 3) Although ROHM is continuously working to improve product reliability and quality, semiconductors can break down and malfunction due to various factors.
Therefore, in order to prevent personal injury or fire arising from failure, please take safety measures such as complying with the derating characteristics, implementing redundant and fire prevention designs, and utilizing backups and fail-safe procedures. ROHM shall have no responsibility for any damages arising out of the use of our Products beyond the rating specified by ROHM.
- 4) Examples of application circuits, circuit constants and any other information contained herein are provided only to illustrate the standard usage and operations of the Products. The peripheral conditions must be taken into account when designing circuits for mass production.
- 5) The technical information specified herein is intended only to show the typical functions of and examples of application circuits for the Products. ROHM does not grant you, explicitly or implicitly, any license to use or exercise intellectual property or other rights held by ROHM or any other parties. ROHM shall have no responsibility whatsoever for any dispute arising out of the use of such technical information.
- 6) The Products are intended for use in general electronic equipment (i.e. AV/OA devices, communication, consumer systems, gaming/entertainment sets) as well as the applications indicated in this document.
- 7) The Products specified in this document are not designed to be radiation tolerant.
- 8) For use of our Products in applications requiring a high degree of reliability (as exemplified below), please contact and consult with a ROHM representative : transportation equipment (i.e. cars, ships, trains), primary communication equipment, traffic lights, fire/crime prevention, safety equipment, medical systems, servers, solar cells, and power transmission systems.
- 9) Do not use our Products in applications requiring extremely high reliability, such as aerospace equipment, nuclear power control systems, and submarine repeaters.
- 10) ROHM shall have no responsibility for any damages or injury arising from non-compliance with the recommended usage conditions and specifications contained herein.
- 11) ROHM has used reasonable care to ensure the accuracy of the information contained in this document. However, ROHM does not warrants that such information is error-free, and ROHM shall have no responsibility for any damages arising from any inaccuracy or misprint of such information.
- 12) Please use the Products in accordance with any applicable environmental laws and regulations, such as the RoHS Directive. For more details, including RoHS compatibility, please contact a ROHM sales office. ROHM shall have no responsibility for any damages or losses resulting non-compliance with any applicable laws or regulations.
- 13) When providing our Products and technologies contained in this document to other countries, you must abide by the procedures and provisions stipulated in all applicable export laws and regulations, including without limitation the US Export Administration Regulations and the Foreign Exchange and Foreign Trade Act.
- 14) This document, in part or in whole, may not be reprinted or reproduced without prior consent of ROHM.



Thank you for your accessing to ROHM product informations.
More detail product informations and catalogs are available, please contact us.

ROHM Customer Support System

<http://www.rohm.com/contact/>

Mouser Electronics

Authorized Distributor

Click to View Pricing, Inventory, Delivery & Lifecycle Information:

[ROHM Semiconductor:](#)

[RGT16NS65DGTL](#) [RGT16NS65DGC9](#)

Данный компонент на территории Российской Федерации

Вы можете приобрести в компании MosChip.

Для оперативного оформления запроса Вам необходимо перейти по данной ссылке:

<http://moschip.ru/get-element>

Вы можете разместить у нас заказ для любого Вашего проекта, будь то серийное производство или разработка единичного прибора.

В нашем ассортименте представлены ведущие мировые производители активных и пассивных электронных компонентов.

Нашей специализацией является поставка электронной компонентной базы двойного назначения, продукции таких производителей как XILINX, Intel (ex.ALTERA), Vicor, Microchip, Texas Instruments, Analog Devices, Mini-Circuits, Amphenol, Glenair.

Сотрудничество с глобальными дистрибьюторами электронных компонентов, предоставляет возможность заказывать и получать с международных складов практически любой перечень компонентов в оптимальные для Вас сроки.

На всех этапах разработки и производства наши партнеры могут получить квалифицированную поддержку опытных инженеров.

Система менеджмента качества компании отвечает требованиям в соответствии с ГОСТ Р ИСО 9001, ГОСТ РВ 0015-002 и ЭС РД 009

Офис по работе с юридическими лицами:

105318, г.Москва, ул.Щербаковская д.3, офис 1107, 1118, ДЦ «Щербаковский»

Телефон: +7 495 668-12-70 (многоканальный)

Факс: +7 495 668-12-70 (доб.304)

E-mail: info@moschip.ru

Skype отдела продаж:

moschip.ru

moschip.ru_4

moschip.ru_6

moschip.ru_9