

FL7760LED1GEVK



ON Semiconductor®

www.onsemi.com

3W SPI Controllable LED Driver Evaluation Board User's Manual

EVAL BOARD USER'S MANUAL

OVERVIEW

This manual covers the specification, theory of operation, testing and construction of the FL7760LED1GEVK demonstration kit. The FL7760 kit demonstrates a 1 A buck LED driver intended for a single high-power LED. The SPI (Serial Peripheral Interface) bus does both analog and PWM dimming. The kit includes a load/SPI interface board to facilitate operation of the driver. The driver can be driven independently from any SPI controller. The nominal input voltage is 12 V.

Table 1. SPECIFICATIONS

Input Voltage	10.8 V dc – 13.2 V dc	
Output Voltage	2.5 V dc – 5.0 V dc	
Output Current	1 A	Max
Output Ripple	40 mA	P–P
Efficiency	85%	Typ.
Switching Frequency	200 kHz	
Rise/Fall Time	< 20 μ s	
Dimming Interface	SPI	
Dimming Resolution	8 bits	
PCB Size	30 mm \times 30 mm	

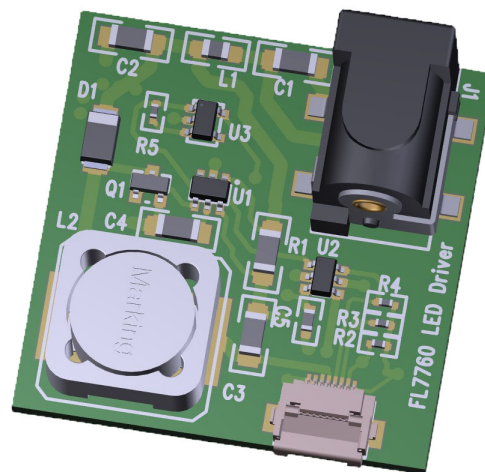

FL7760LED1GEVK
Evaluation Board

The key features of this demo kit include:

- Low Parts Count
- Single Sided Assembly
- Small Footprint
- Very Fast Rise/Fall Times
- SPI Dimming Control for Analog and PWM Dimming
- 12 V Operation
- Integrated Thermal Shutdown and UVLO

THEORY OF OPERATION

Power Stage

The power stage is a CCM inverted buck converter. The output inductor sets the switching frequency because the control operates in hysteretic control mode. The peak and valley current are fixed percentages of the current reference. This fixes the inductor ripple current and eliminates the need for closed loop compensation. A novel high side current sense enables direct accurate control of the output current.

FL7760LED1GEVK

HV Start

The FL7760 supplies its own Vcc power greatly simplifying implementation. The input voltage range is 8 V – 70V. The internal Vcc regulates to 5 V ± 10%. The internal Vcc supplies a 3.3 V LDO for powering the DAC. The regulator and DAC draw less than 1mA combined.

Dimming

The FL7760 dim input controls both amplitude and on/off control. This makes the dim interface controllable by analog, PWM, or both at the same time. The DAC has an output range of 0 V – 3.3 V for 8 bits of resolution. A dim signal below 0.5 V turns off the output and a dim signal above 3 V is 100% output.

Protection

Thermal Protection

The thermal protection is built into the FL7760 and shuts down the FL7760 when the die temperature exceeds 150°C.

OVP

The output voltage is inherently limited to be less than or equal to Vin. As such, no OVP is required due this inherent limitation.

Load Board Operation

The load board connects to the LED driver via an 8 conductor FPC cable. The FPC cable makes a simple and convenient interconnection. The load board serves 2 major functions: 1) provide an easy connection to an LED load 2) provide a USB–SPI bridge for computer control of the LED driver.

The daughter card on the load has a mini USB–A connection for attachment to your computer. See the test procedure for details of the setup of the SPI terminal application.

SCHEMATIC

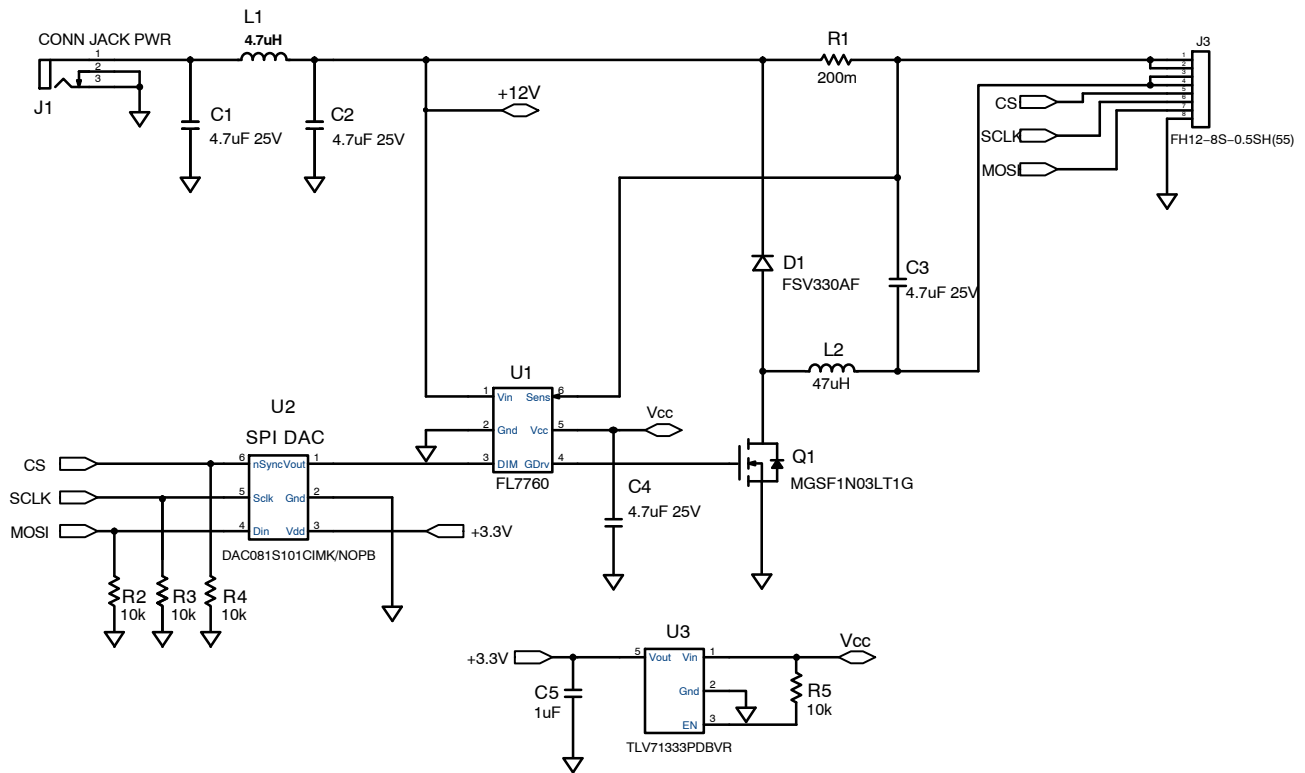

Figure 1. LED Driver Circuit

FL7760LED1GEVK

TEST PROCEDURE

Equipment Needed

DC Source – 12 V ± 5% @ 1 A

2 – DC Voltmeter – 300 V dc minimum 0.1% accuracy or better

2 – DC Ammeter – 1 A dc minimum 0.1% accuracy or better

LED Load – 2.5 V – 5.0 V @ 1.0 A

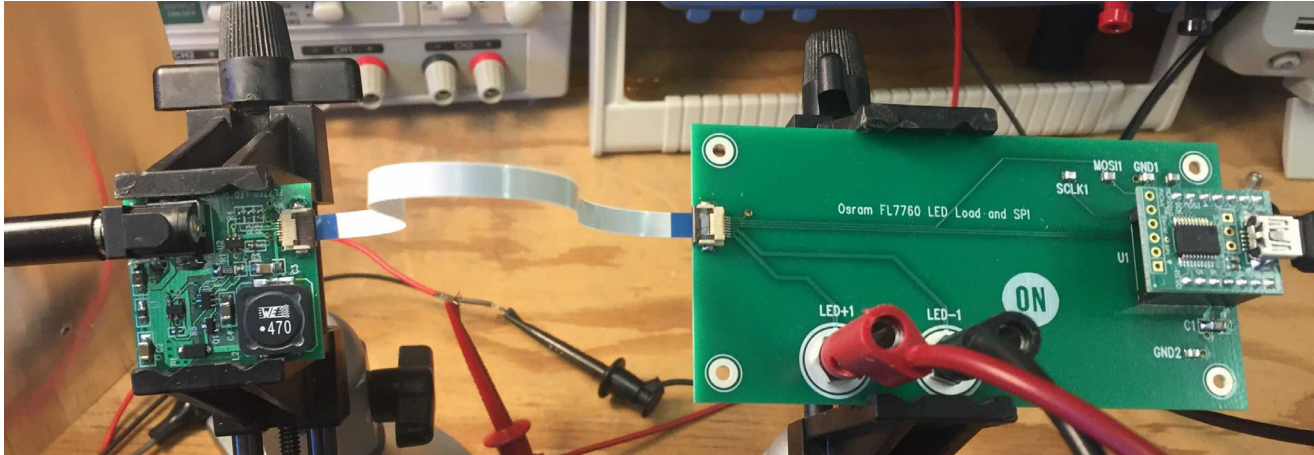

Figure 3. Test Set Up

The Connections

1. Connect the LED load board to the LED driver using the FPC cable provided in the kit.
2. Connect red (+) and black (-) leads through the ammeter to the LED load.
3. Connect a 12 V dc source to the input power connector.

NOTE: Unless otherwise specified, all voltage measurements are taken at the terminals of the UUT.

Functional Test Procedure

1. Set the LED Load for 3.5 V output.
2. Set the input voltage to 12 V.
3. Measure input voltage and current.
4. Measure output voltage and current.

Regulation

See Table 3.

Table 3. REGULATION

DAC Data	I _{out} Target	Output Current	Output Voltage	Input Voltage	Input Current
00 00	0 A				
0F F0	1 A ± 5%				
07 00	0.5 A ± 5%				

$$\text{Efficiency} = \frac{V_{\text{out}} \times I_{\text{out}}}{V_{\text{in}} \times I_{\text{in}}} \times 100\%$$

FL7760LED1GEVK

TEST DATA

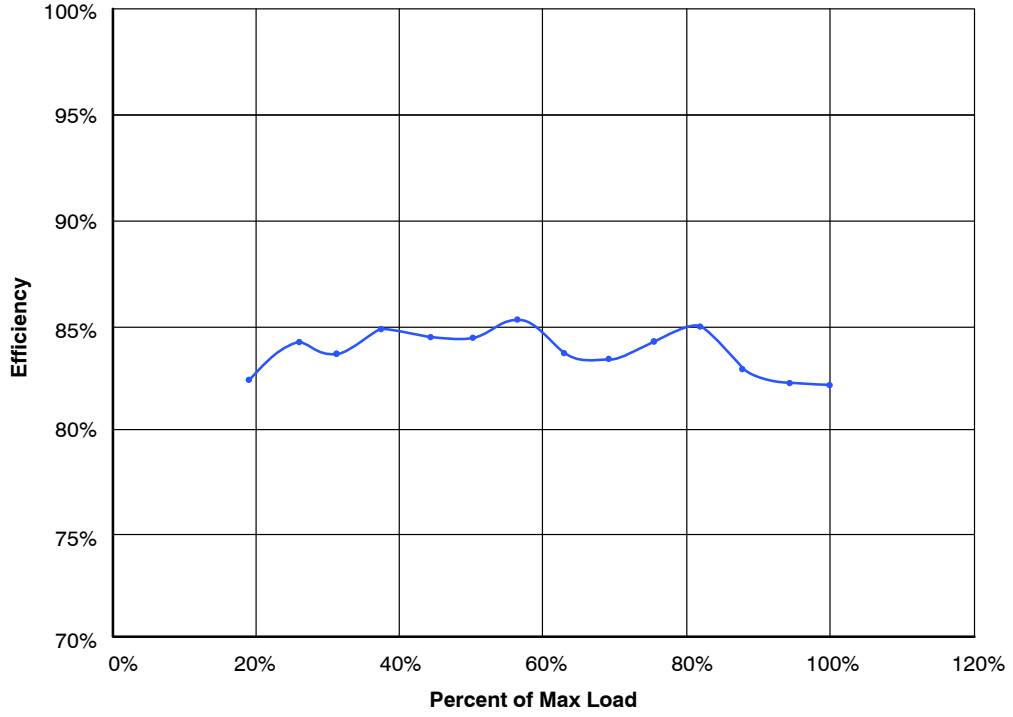

Figure 4. Efficiency

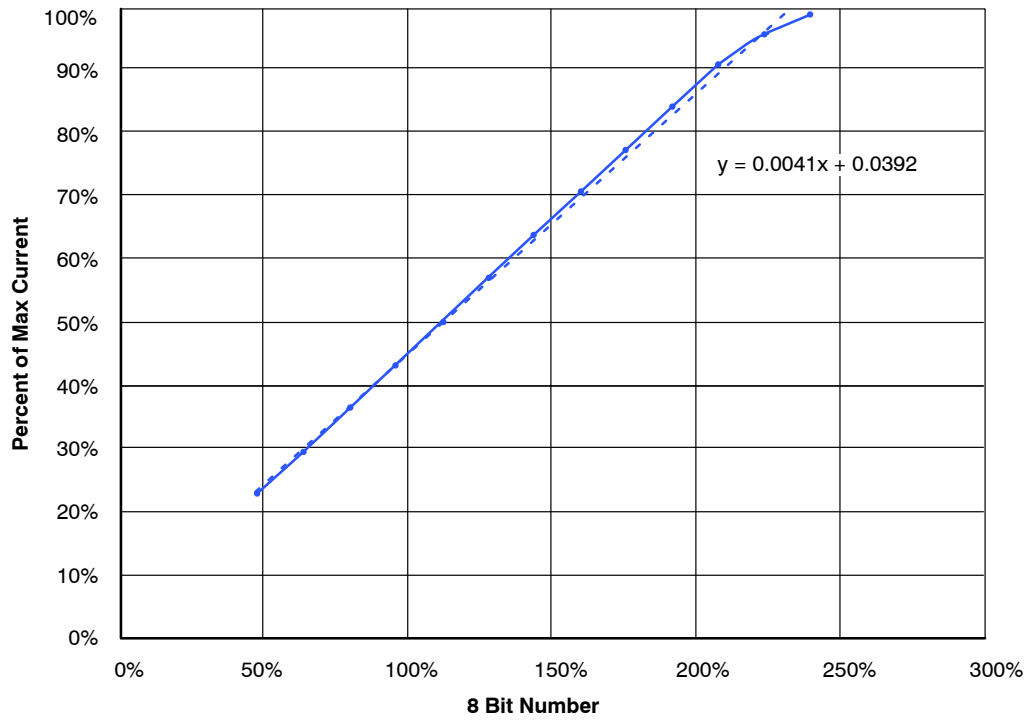

Figure 5. Dim Curve

FL7760LED1GEVK

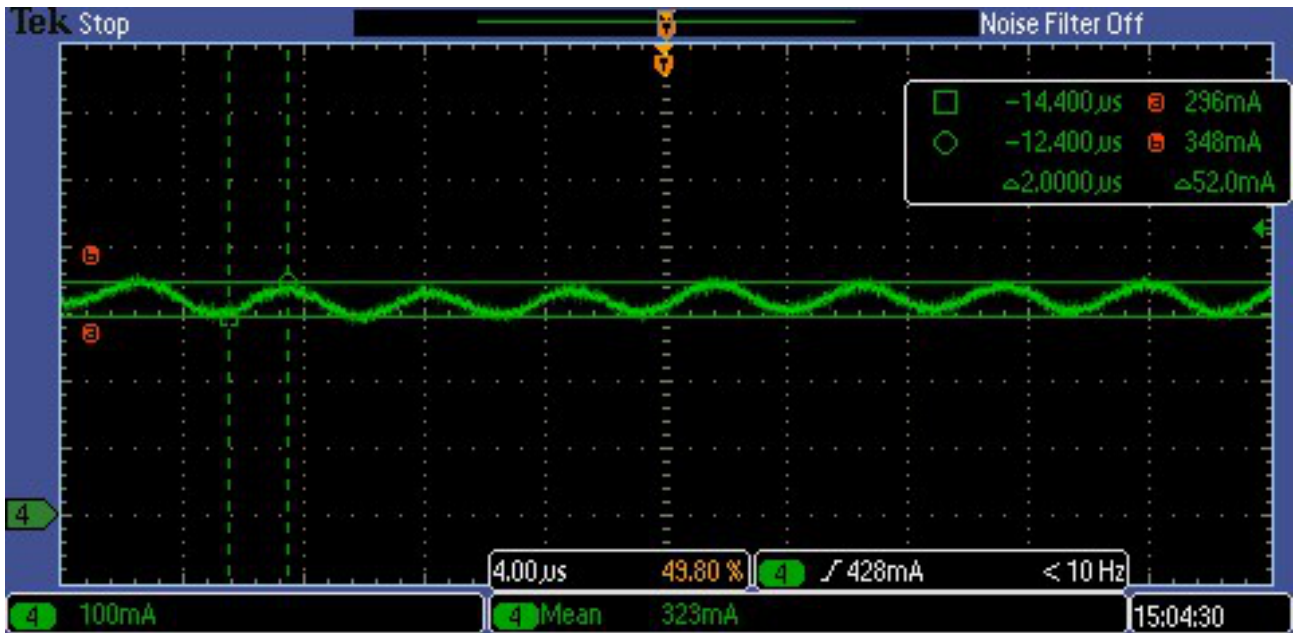

Figure 6. Input Current Ripple



Figure 7. Output Current Ripple

FL7760LED1GEVK

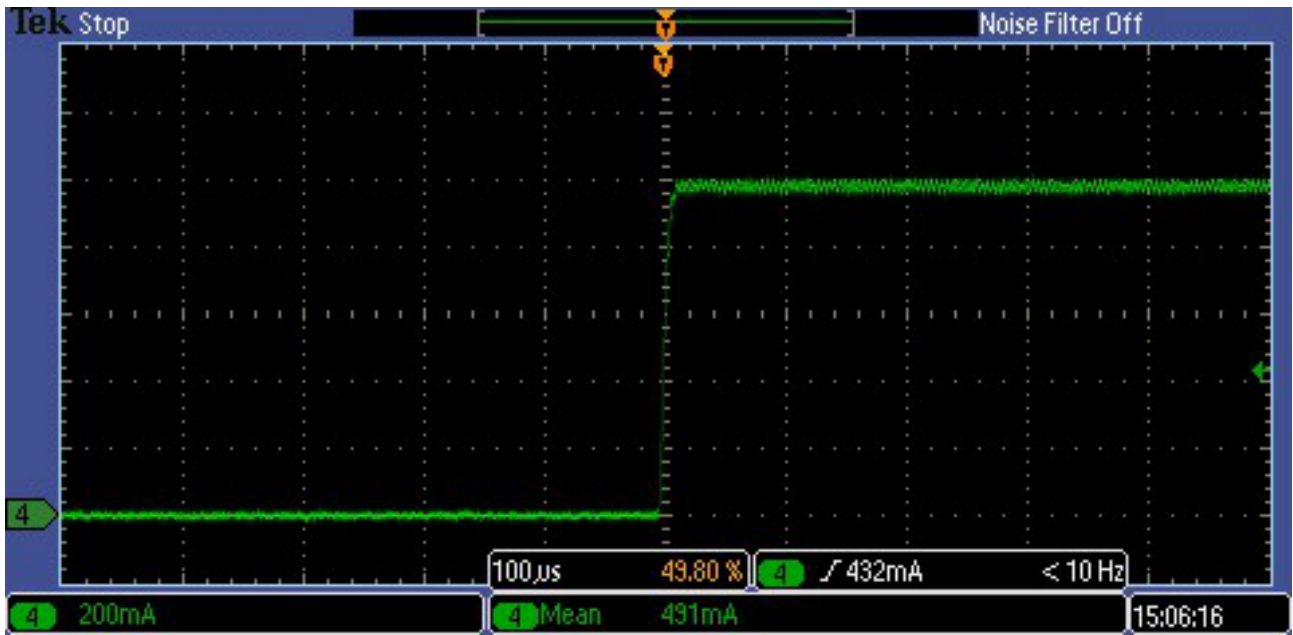

Figure 8. Input Current Rise

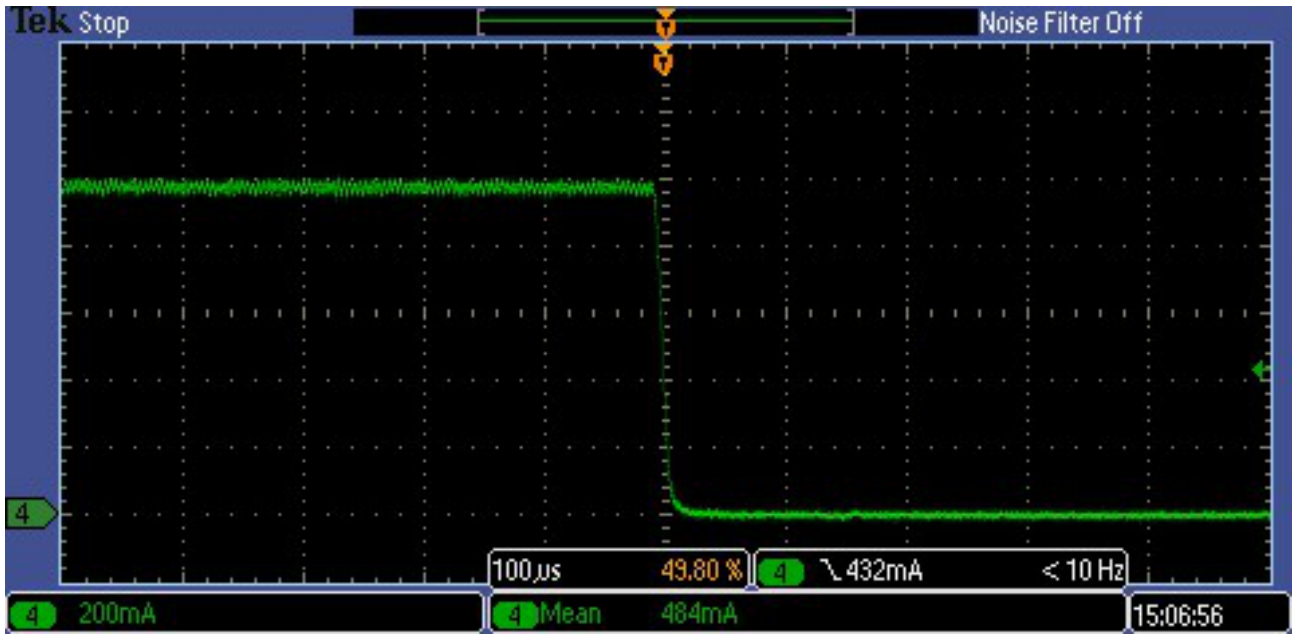

Figure 9. Output Current Fall

FL7760LED1GEVK

THERMAL IMAGE

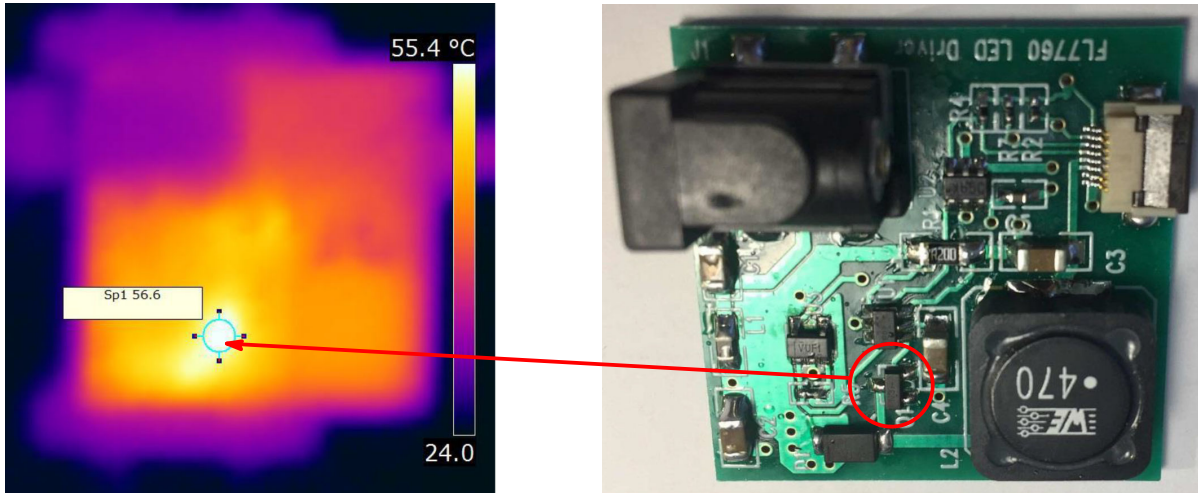

Figure 10.

ON Semiconductor and the ON Semiconductor logo are trademarks of Semiconductor Components Industries, LLC dba ON Semiconductor or its subsidiaries in the United States and/or other countries. ON Semiconductor owns the rights to a number of patents, trademarks, copyrights, trade secrets, and other intellectual property. A listing of ON Semiconductor's product/patent coverage may be accessed at www.onsemi.com/site/pdf/Patent-Marking.pdf. ON Semiconductor is an Equal Opportunity/Affirmative Action Employer. This literature is subject to all applicable copyright laws and is not for resale in any manner.

The evaluation board/kit (research and development board/kit) (hereinafter the "board") is not a finished product and is as such not available for sale to consumers. The board is only intended for research, development, demonstration and evaluation purposes and should as such only be used in laboratory/development areas by persons with an engineering/technical training and familiar with the risks associated with handling electrical/mechanical components, systems and subsystems. This person assumes full responsibility/liability for proper and safe handling. Any other use, resale or redistribution for any other purpose is strictly prohibited.

The board is delivered "AS IS" and without warranty of any kind including, but not limited to, that the board is production-worthy, that the functions contained in the board will meet your requirements, or that the operation of the board will be uninterrupted or error free. ON Semiconductor expressly disclaims all warranties, express, implied or otherwise, including without limitation, warranties of fitness for a particular purpose and non-infringement of intellectual property rights.

ON Semiconductor reserves the right to make changes without further notice to any board.

You are responsible for determining whether the board will be suitable for your intended use or application or will achieve your intended results. Prior to using or distributing any systems that have been evaluated, designed or tested using the board, you agree to test and validate your design to confirm the functionality for your application. Any technical, applications or design information or advice, quality characterization, reliability data or other services provided by ON Semiconductor shall not constitute any representation or warranty by ON Semiconductor, and no additional obligations or liabilities shall arise from ON Semiconductor having provided such information or services.

The boards are not designed, intended, or authorized for use in life support systems, or any FDA Class 3 medical devices or medical devices with a similar or equivalent classification in a foreign jurisdiction, or any devices intended for implantation in the human body. Should you purchase or use the board for any such unintended or unauthorized application, you shall indemnify and hold ON Semiconductor and its officers, employees, subsidiaries, affiliates, and distributors harmless against all claims, costs, damages, and expenses, and reasonable attorney fees arising out of, directly or indirectly, any claim of personal injury or death associated with such unintended or unauthorized use, even if such claim alleges that ON Semiconductor was negligent regarding the design or manufacture of the board.

This evaluation board/kit does not fall within the scope of the European Union directives regarding electromagnetic compatibility, restricted substances (RoHS), recycling (WEEE), FCC, CE or UL, and may not meet the technical requirements of these or other related directives.

FCC WARNING – This evaluation board/kit is intended for use for engineering development, demonstration, or evaluation purposes only and is not considered by ON Semiconductor to be a finished end product fit for general consumer use. It may generate, use, or radiate radio frequency energy and has not been tested for compliance with the limits of computing devices pursuant to part 15 of FCC rules, which are designed to provide reasonable protection against radio frequency interference. Operation of this equipment may cause interference with radio communications, in which case the user shall be responsible, at its expense, to take whatever measures may be required to correct this interference.

ON Semiconductor does not convey any license under its patent rights nor the rights of others.

LIMITATIONS OF LIABILITY: ON Semiconductor shall not be liable for any special, consequential, incidental, indirect or punitive damages, including, but not limited to the costs of requalification, delay, loss of profits or goodwill, arising out of or in connection with the board, even if ON Semiconductor is advised of the possibility of such damages. In no event shall ON Semiconductor's aggregate liability from any obligation arising out of or in connection with the board, under any theory of liability, exceed the purchase price paid for the board, if any.

For more information and documentation, please visit www.onsemi.com.

PUBLICATION ORDERING INFORMATION

LITERATURE FULFILLMENT:

Email Requests to: orderlit@onsemi.com

ON Semiconductor Website: www.onsemi.com

TECHNICAL SUPPORT

North American Technical Support:

Voice Mail: 1 800-282-9855 Toll Free USA/Canada

Phone: 011 421 33 790 2910

Europe, Middle East and Africa Technical Support:

Phone: 00421 33 790 2910

For additional information, please contact your local Sales Representative

Данный компонент на территории Российской Федерации

Вы можете приобрести в компании MosChip.

Для оперативного оформления запроса Вам необходимо перейти по данной ссылке:

<http://moschip.ru/get-element>

Вы можете разместить у нас заказ для любого Вашего проекта, будь то серийное производство или разработка единичного прибора.

В нашем ассортименте представлены ведущие мировые производители активных и пассивных электронных компонентов.

Нашей специализацией является поставка электронной компонентной базы двойного назначения, продукции таких производителей как XILINX, Intel (ex.ALTERA), Vicor, Microchip, Texas Instruments, Analog Devices, Mini-Circuits, Amphenol, Glenair.

Сотрудничество с глобальными дистрибьюторами электронных компонентов, предоставляет возможность заказывать и получать с международных складов практически любой перечень компонентов в оптимальные для Вас сроки.

На всех этапах разработки и производства наши партнеры могут получить квалифицированную поддержку опытных инженеров.

Система менеджмента качества компании отвечает требованиям в соответствии с ГОСТ Р ИСО 9001, ГОСТ РВ 0015-002 и ЭС РД 009

Офис по работе с юридическими лицами:

105318, г.Москва, ул.Щербаковская д.3, офис 1107, 1118, ДЦ «Щербаковский»

Телефон: +7 495 668-12-70 (многоканальный)

Факс: +7 495 668-12-70 (доб.304)

E-mail: info@moschip.ru

Skype отдела продаж:

moschip.ru

moschip.ru_4

moschip.ru_6

moschip.ru_9