

**B**  
TSS Series

**Slide Switches, Vertical, Single or Dual Actuator**

**MATERIAL SPECIFICATIONS:**

Contacts .....Copper w/gold plate over nickel  
 Case Material .....High temperature polyester (94-VO)  
 Actuator Material .....Polyester (94-VO)  
 Terminals .....Copper alloy tin/lead/nickel or gold/nickel  
 Terminal Seal .....Epoxy standard: single pole, optional: double pole

**TYPICAL PERFORMANCE CHARACTERISTICS:**

Contact Rating .....Gold: 0.4 VA max. @ 20 VDC or peak AC  
 Initial Contact Resistance .....20 Milliohms max.  
 Contact Timing .....Non-shorting  
 Insulation Resistance .....1,000 Megohms min. @ 500 VDC  
 Dielectric Strength .....1,000 Volts RMS @ sea level  
 Plunger/Actuator Travel .....0.120" (3.05)  
 Life Expectancy .....Up to 60,000-80,000 Cycles

**ENVIRONMENTAL SPECIFICATIONS:**

Operating Temperature .....-4°F to + 176°F (-20°C to + 80°C)  
 Storage Temperature .....-4°F to + 176°F (-20°C to + 80°C)

**SPST/SPDT**

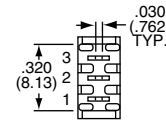
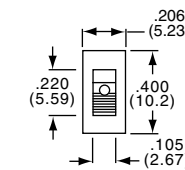
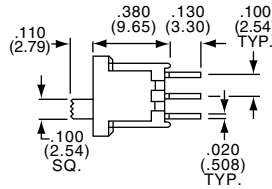

**SPST/SPDT (DUAL)**

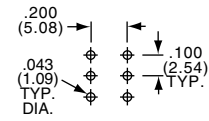
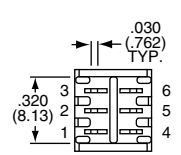
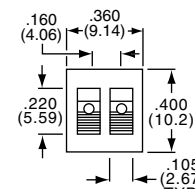
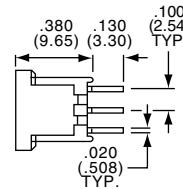

Extended Actuator Tyco Electronics	Alcoswitch	Type	Act. Code P. M6	On	None	Off	Extended Dual Actuator Tyco Electronics	Alcoswitch	Type	Act. Code P. M6	On	None	Off
1437578-3	TSS11AGPC	SPST	A	On	None	Off	—	TSD21AAGPC	2 x SPST	A	On	None	Off
1-1437589-0	TSS11DGPC	SPDT	D	On	None	On	1437579-5	TSD21DDGPC	2 x SPDT	D	On	None	On
1-1437579-4	TSS11EGPC	SPDT	E	On	Off	On	<b>Flush Dual Actuator</b>						
—	TSS11AG1PC	SPST	A	On	None	Off	—	TSD21DDG1PC	2 x SPDT	D	On	None	On
1437579-8	TSS11DG1PC	SPDT	D	On	None	On							
1-1437579-2	TSS11EG1PC	SPDT	E	On	Off	On							

Note: No center terminals on "A" action switches.

**DPST/DPDT**

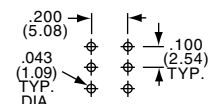
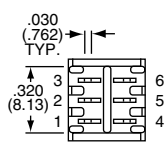
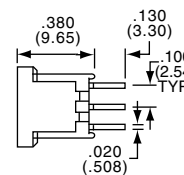
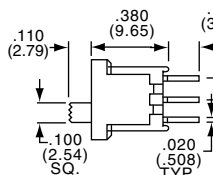
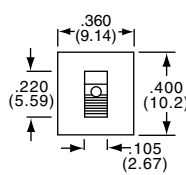

Extended Actuator Tyco Electronics	Alcoswitch	Type	Act. Code P. M6	On	None	Off	Flush Actuator Tyco Electronics	Alcoswitch	Act. Code Type	P. M6	On	None	Off
1-1437579-6	TSS21KGPC	DPST	K	On	None	Off	—	TSS21KG1PC	DPST	K	On	None	Off
1-1437579-9	TSS21NGPC	DPDT	N	On	None	On	1-1437579-7	TSS21NG1PC	DPDT	N	On	None	On
2-1437579-3	TSS21PGPC	DPDT	P	On	Off	On	2-1437579-1	TSD21RG1PC	DPDT	P	On	Off	On

Note: No center terminals on "K" action switches.

**4PDT**

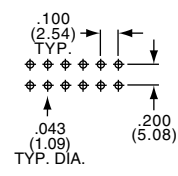
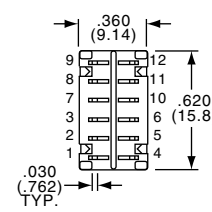
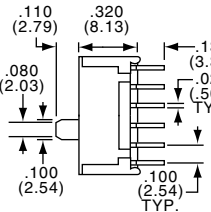
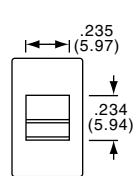

Extended Actuator Tyco Electronics	Alcoswitch	Type	Act. Code P. M6	On	None	Off
2-1437579-5	TSS41NGPC	4PDT	N	On	None	On

**Slide Switches, Right Angle, Single or Dual Actuator**

SEE PAGE B18 FOR PRODUCT SPECIFICATIONS

SPDT



Extended Actuator			Act. Code			Flush Actuator			Act. Code			
Tyco Electronics	Alcoswitch	Type	P. M6	On	None	Tyco Electronics	Alcoswitch	Type	P. M6	On	None	On
1-1437579-1	TSS11DGRA	SPDT	D	On	None	1437579-9	TSS11DG1RA	SPDT	D	On	None	On
1-1437579-5	TSS11EGRA	SPDT	E	On	Off	1-1437579-3	TSS11EG1RA	SPDT	E	On	Off	On

SPDT (DUAL)

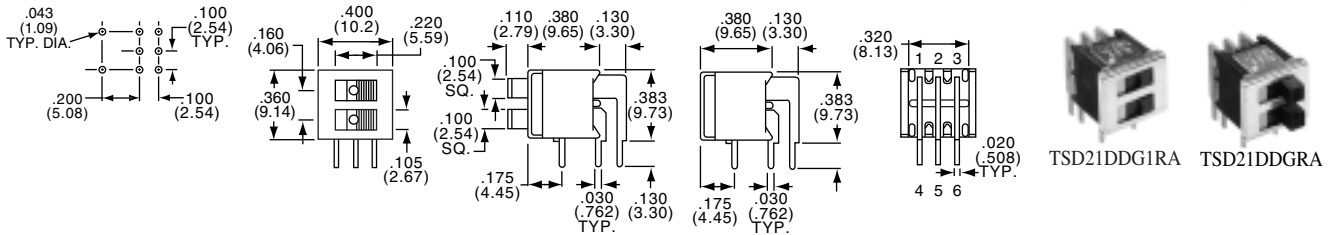

Extended Actuator			Act. Code			Flush Actuator			Act. Code			
Tyco Electronics	Alcoswitch	Type	P. M6	On	None	Tyco Electronics	Alcoswitch	Type	P. M6	On	None	On
1437579-6	TSD21DDGRA	2 x SPDT	D	On	None	1437579-4	TSD21DDG1RA	2 x SPDT	D	On	None	On
1437579-7	TSD21EEGRA	2 x SPDT	E	On	Off	—	TSD21EEG1RA	2 x SPDT	E	On	Off	On

DPDT

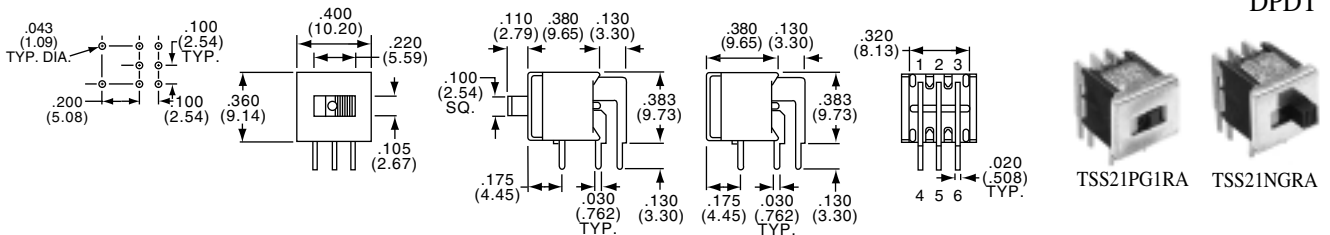

Extended Actuator			Act. Code			Flush Actuator			Act. Code			
Tyco Electronics	Alcoswitch	Type	P. M6	On	None	Tyco Electronics	Alcoswitch	Type	P. M6	On	None	On
—	TSS21PAGRA	SP3T	PA	On	On	—	TSS21NG1RA	DPDT	N	On	None	On
2-1437579-0	TSS21NGRA	DPDT	N	On	None	—	TSS21PG1RA	DPDT	P	On	Off	On
2-1437579-4	TSS21PGRA	DPDT	P	On	Off	—	—	—	—	—	—	—

4PDT

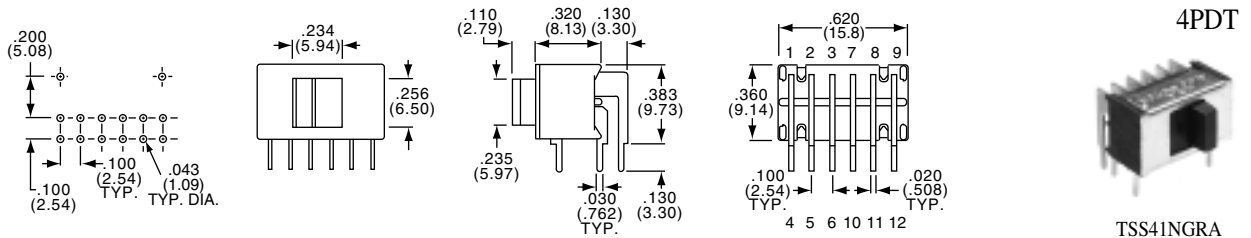

Extended Actuator			Act. Code			
Tyco Electronics	Alcoswitch	Type	P. M6	On	None	On
2-1437579-7	TSS41NGRA	4PDT	N	On	None	On

**Slide Switches, Instrumentation Grade**

**MATERIAL SPECIFICATIONS:**

Contacts .....Gold or silver over nickel/copper alloy  
 Frame Material .....Tin plated steel  
 Terminals/Fixed Contacts.....Gold or silver over nickel/over copper alloy  
 Terminal Seal .....Epoxy  
 Actuator Material .....POM-UL94HB

**ENVIRONMENTAL SPECIFICATIONS:**

Operating Temperature.....-4°F to +185°F (-20°C to +85°C)  
 Storage Temperature.....-40°F to +212°F (-40°C to +100°C)  
 Solder Heat Resistance .....See page M3-4

**TYPICAL PERFORMANCE CHARACTERISTICS:**

Contact Rating .....Gold: 0.4 VA 20 VDC or peak AC  
 Silver: 300 mA @ 125 VAC  
 Initial Contact Resistance .....20 Milliohms max.  
 Contact Timing .....Make before break  
 Insulation Resistance .....1,000 Megohms min.  
 Dielectric Strength .....500 VAC  
 Actuation Force .....100 to 600 Grams  
 Life Expectancy .....Up to 15,000 Cycles  
 Travel .....0.079" (2.01) (unless otherwise specified)

**B**  
MSS Series

**SPDT**



MSS1200

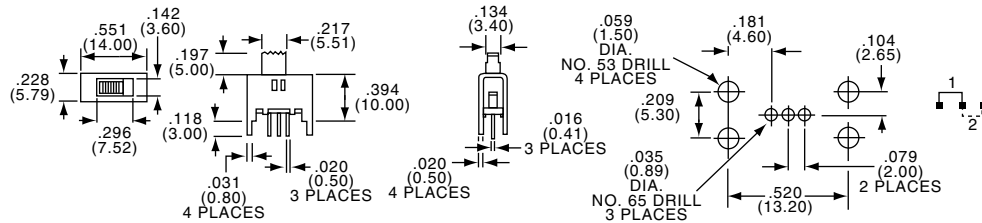

MSS1200R



Tyco Electronics	Alcoswitch	Plating	Tyco Electronics	Alcoswitch	Plating
5-1437576-0	MSS1200	Silver	5-1437576-2	MSS1200R	Silver
5-1437576-1	MSS1200G	Gold	5-1437576-3	MSS1200RG	Gold

**SP3T**



MSS1300



MSS1300R



Tyco Electronics	Alcoswitch	Plating	Tyco Electronics	Alcoswitch	Plating	Total Actuator Travel
5-1437576-4	MSS1300	Silver	5-1437576-6	MSS1300R	Silver	.098(2.50)
5-1437576-5	MSS1300G	Gold	5-1437576-7	MSS1300RG	Gold	.098(2.50)

**Slide Switches, Instrumentation Grade**

SEE PAGE B20 FOR PRODUCT SPECIFICATIONS

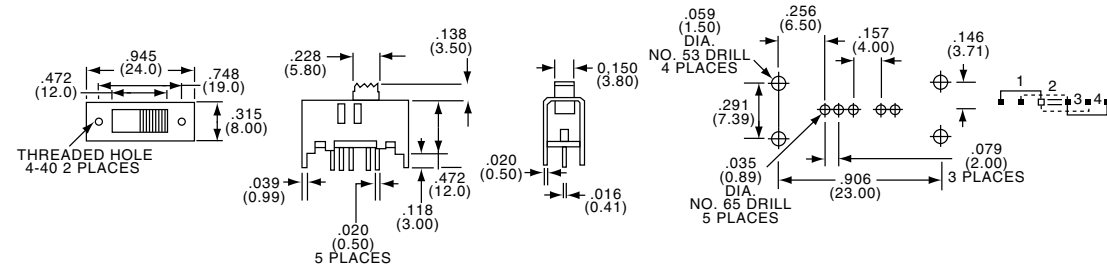

SP4T



MSS1400

Tyco Electronics	Alcoswitch	Plating
5-1437576-8	MSS1400	Silver
1571423-1	MSS1400G	Gold

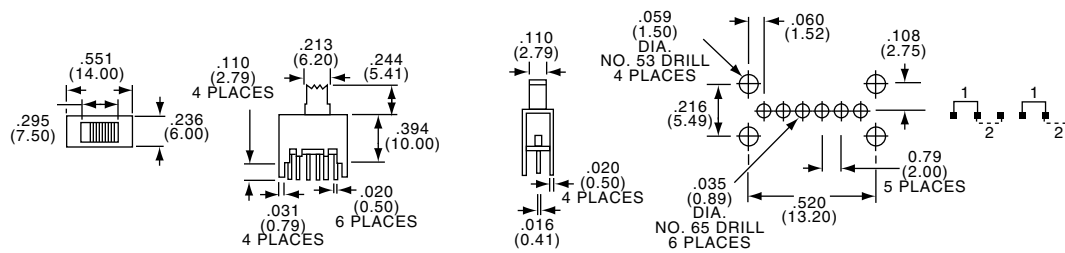

DPDT



MSS225

Tyco Electronics	Alcoswitch	Plating
6-1437576-3	MSS2225	Silver
6-1437576-4	MSS2225G	Gold

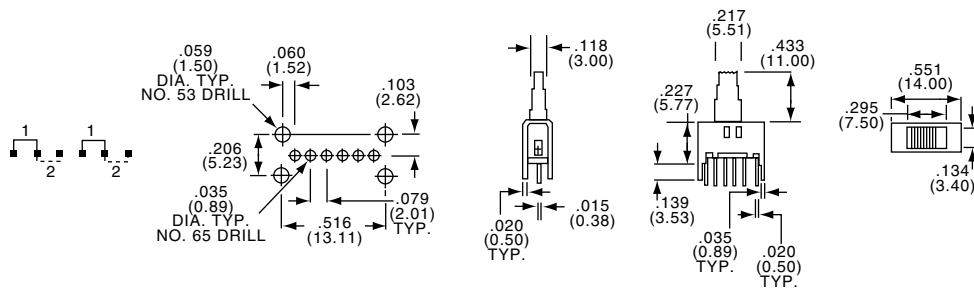

DPDT



MSS2250

Tyco Electronics	Alcoswitch	Plating
6-1437576-5	MSS2250	Silver
6-1437576-6	MSS2250G	Gold

**Slide Switches, Instrumentation Grade**

DPDT



MSS2250R

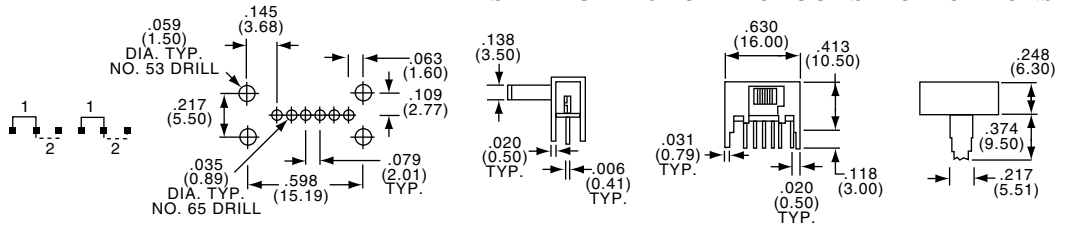

SEE PAGE B20 FOR PRODUCT SPECIFICATIONS

Tyco Electronics	Alcoswitch	Plating
6-1437576-7	MSS2250R	Silver
6-1437576-8	MSS2250RG	Gold

4PDT



MSS4200

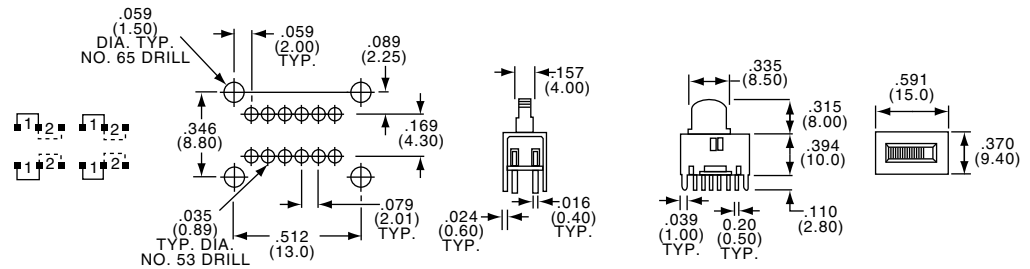

Tyco Electronics	Alcoswitch	Plating
6-1437576-9	MSS4200	Silver
7-1437576-0	MSS4200G	Gold

4PDT



MSS4250



Tyco Electronics	Alcoswitch	Plating
7-1437576-4	MSS4250	Silver

**Slide Switches, Instrumentation Grade**

SEE PAGE B20 FOR PRODUCT SPECIFICATIONS



Tyco Electronics	Alcoswitch	Plating
7-1437576-2	MSS4200R	Silver
7-1437576-3	MSS4200RG	Gold

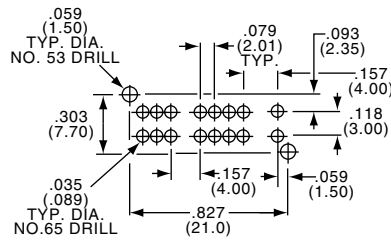
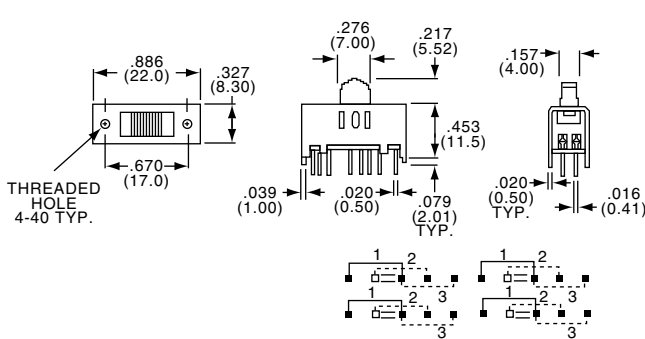

Tyco Electronics	Alcoswitch	Plating
7-1437576-5	MSS4300	Silver
7-1437576-6	MSS4300G	Gold

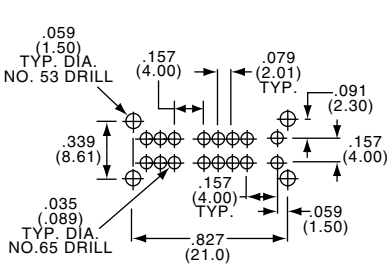
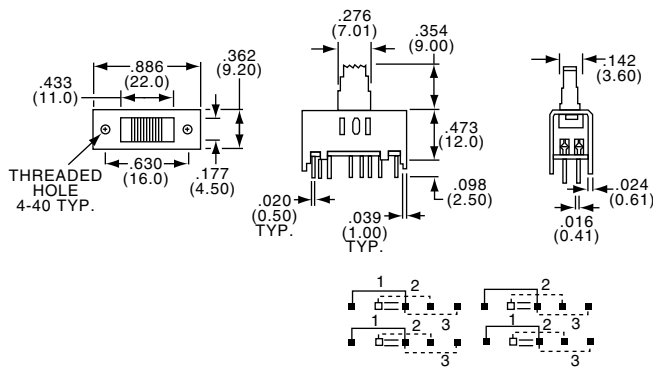

Tyco Electronics	Alcoswitch	Plating
7-1437576-9	MSS4335	Silver

## Данный компонент на территории Российской Федерации

### Вы можете приобрести в компании MosChip.

Для оперативного оформления запроса Вам необходимо перейти по данной ссылке:

<http://moschip.ru/get-element>

Вы можете разместить у нас заказ для любого Вашего проекта, будь то серийное производство или разработка единичного прибора.

В нашем ассортименте представлены ведущие мировые производители активных и пассивных электронных компонентов.

Нашей специализацией является поставка электронной компонентной базы двойного назначения, продукции таких производителей как XILINX, Intel (ex.ALTERA), Vicor, Microchip, Texas Instruments, Analog Devices, Mini-Circuits, Amphenol, Glenair.

Сотрудничество с глобальными дистрибьюторами электронных компонентов, предоставляет возможность заказывать и получать с международных складов практически любой перечень компонентов в оптимальные для Вас сроки.

На всех этапах разработки и производства наши партнеры могут получить квалифицированную поддержку опытных инженеров.

Система менеджмента качества компании отвечает требованиям в соответствии с ГОСТ Р ИСО 9001, ГОСТ РВ 0015-002 и ЭС РД 009

### Офис по работе с юридическими лицами:

105318, г.Москва, ул.Щербаковская д.3, офис 1107, 1118, ДЦ «Щербаковский»

Телефон: +7 495 668-12-70 (многоканальный)

Факс: +7 495 668-12-70 (доб.304)

E-mail: [info@moschip.ru](mailto:info@moschip.ru)

Skype отдела продаж:

moschip.ru

moschip.ru\_4

moschip.ru\_6

moschip.ru\_9