

Applications

- X-Band Radar
- Satellite Communication Systems

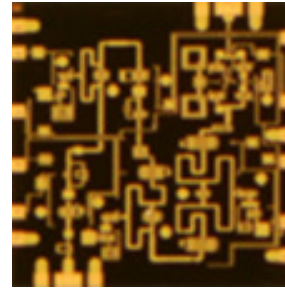

Product Features

- Frequency Range: 8 to 12 GHz
- 6-Bit Digital Phase Shifter
- Bi-Directional
- 360° Coverage, LSB = 5.625°
- RMS Phase Error: 4°
- RMS Amplitude Error: 0.5 dB
- Insertion Loss: 6 dB
- Return Loss: 10 dB IRL; 15 dB ORL
- Input P1dB: 29 dBm
- Input IP3: >40 dBm
- IM3: <-50 dBc
- Control Voltage: 0/+5 V
- Dimensions: 2.2 x 2.2 x 0.1 mm

General Description

The Qorvo TGP2109 is a 6-bit digital phase shifter fabricated on Qorvo's high performance 0.15µm GaAs pHEMT process. It operates over 8 to 12 GHz and provides 360° of phase coverage with a LSB of 5.625°. It also achieves a low RMS phase error of 4° with 6 dB of insertion loss.

The TGP2109 was developed for simple system integration. It uses positive only switch logic; eliminating the need for a negative voltage rail. In addition, both ports are matched to 50 ohms with DC blocking capacitors. Ease of use along with low insertion loss and a high degree of resolution makes the TGP2109 ideally suited for a variety of x-band phased array applications including commercial and military radars and phase array communication systems.

The device is lead-free and RoHS compliant.

Evaluation Boards are available upon request.

Functional Block Diagram

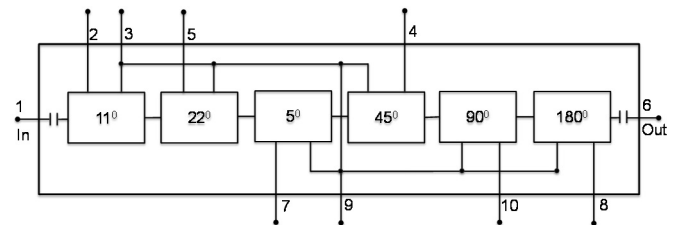

Pad Configuration

Pad No.	Symbol
1	RF In
2	11°
3, 9	REF
4	45°
5	22°
6	RF Out
7	5°
8	180°
10	90°

Ordering Information

Part	ECCN	Description
TGP2109	EAR99	8-12GHz 6-Bit Digital Phase Shifter

Absolute Maximum Ratings

Parameter	Value
Control and Reference Voltage	6 V
Control Current	0.5 mA
Power Dissipation	1.5 W
Input Power, CW, 50 Ω, 85°C	33 dBm
Channel Temperature	200 °C
Mounting Temperature (30 Seconds)	320 °C
Storage Temperature	-55 to 150 °C

Operation of this device outside the parameter ranges given above may cause permanent damage. These are stress ratings only, and functional operation of the device at these conditions is not implied.

Recommended Operating Conditions

Parameter	Value
Control Voltage (5°, 11°, 22°, 45°, 90°, 180°)	0/+5 V
Reference Voltage (V _{REF})	+5 V
Current (I _{REF} , I _{CTRL})	< 50 μA

Electrical specifications are measured at specified test conditions. Specifications are not guaranteed over all operating conditions.

Electrical Specifications

Test conditions unless otherwise noted: 25°C. Control Voltage (REF, 5°, 11°, 22°, 45°, 90°, 180°) = 0/+5 V; See Bias Truth Table.

Parameter	Min	Typical	Max	Units
Operational Frequency Range	8		12	GHz
Insertion Loss		6		dB
Input Return Loss		10		dB
Output Return Loss		15		dB
RMS Phase Error		4		deg
RMS Amplitude Error		0.5		dB
Input P1dB		29		dBm
Input IP3 (Tone Spacing = 10 MHz, Pin/Tone = 16 dBm)		> 40		dBm
IM3 (Tone Spacing = 10 MHz, Pin/Tone = 16 dBm)		< -50		dBc
Insertion Loss Temperature Coefficient		0.004		dB/°C

Bias Truth Table

Logic "0" = 0 V, Logic "1" = V_{REF} = +5 V

Phase Shifter	5°	11°	22°	45°	90°	180°	REF
0° (Reference)	0	0	1	1	1	1	1
5°	1	0	1	1	1	1	1
11°	0	1	1	1	1	1	1
22°	0	0	0	1	1	1	1
45°	0	0	1	0	1	1	1
90°	0	0	1	1	0	1	1
180°	0	0	1	1	1	0	1
355°	1	1	0	0	0	0	1

Thermal and Reliability Information

Parameter	Test Conditions	Value	Units
Channel Temperature (T_{CH})	$T_{BASEPLATE} = 85^{\circ}\text{C}$	85	$^{\circ}\text{C}$
Median Lifetime (T_M)		5.2E+9	Hrs

Notes:
 Under normal (lifetime) operating conditions, self-heating is not a significant contributor to channel temperature.

Median Lifetime

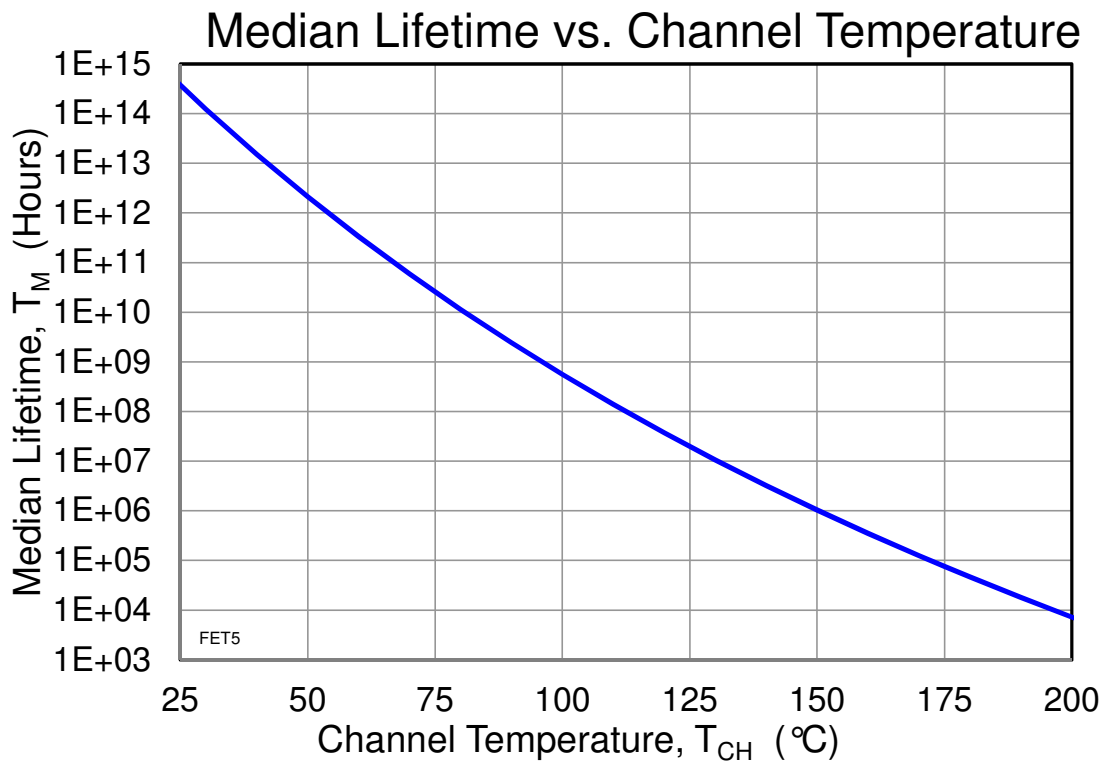

Typical Performance – Small Signal

Test conditions unless otherwise noted: 5V and 3V, 25 °C

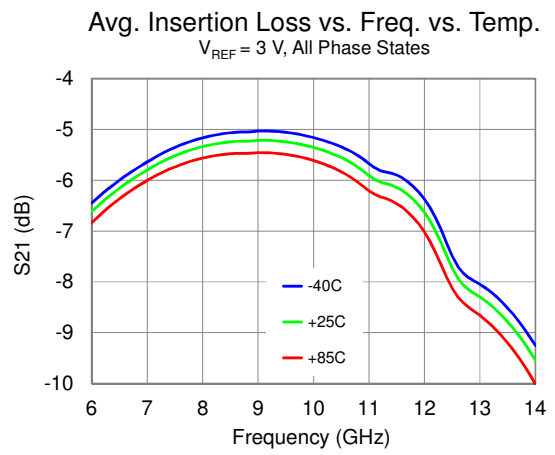
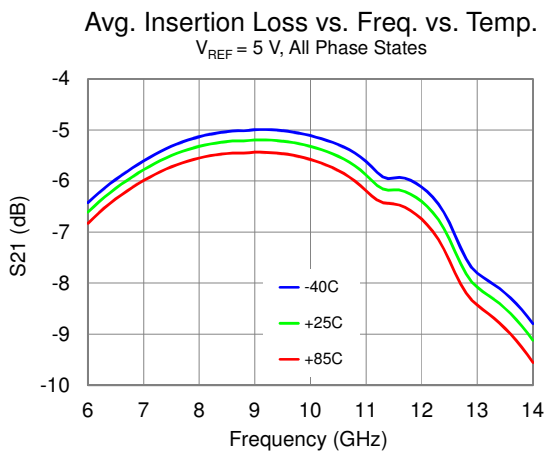
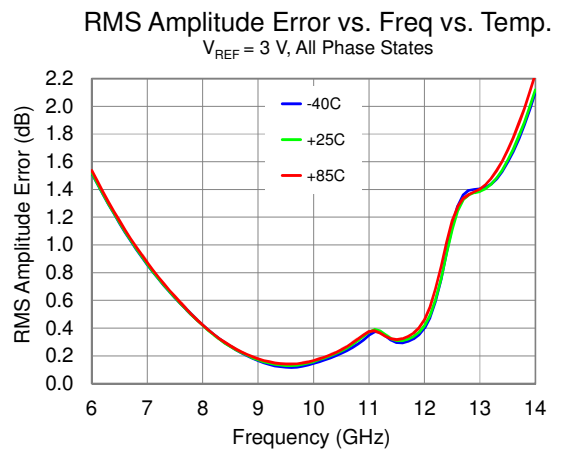
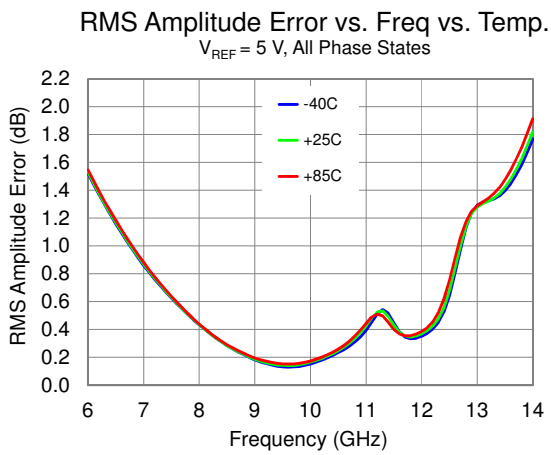
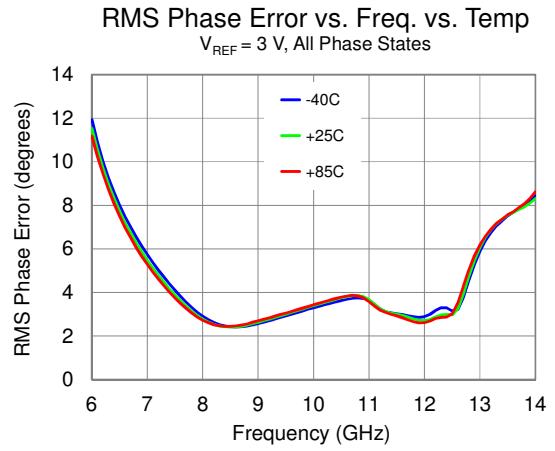
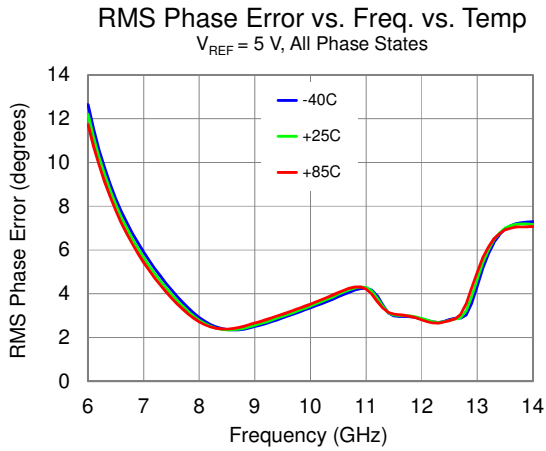

Typical Performance – Small Signal (Cont.)

Test conditions unless otherwise noted: 5V and 3V, 25 °C

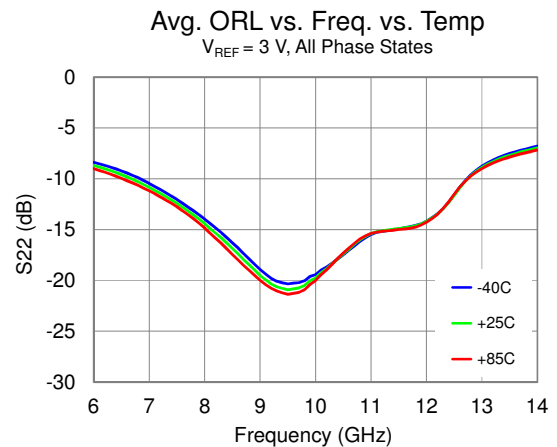
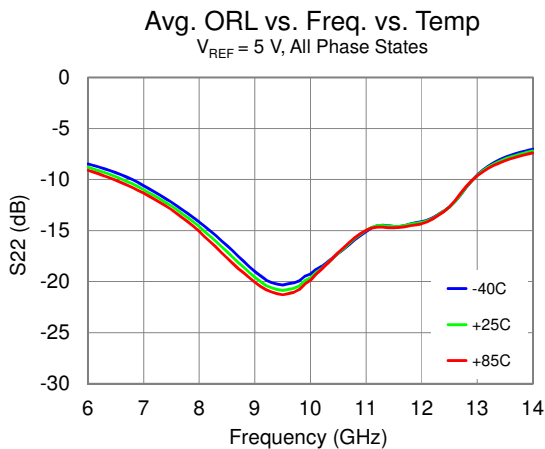
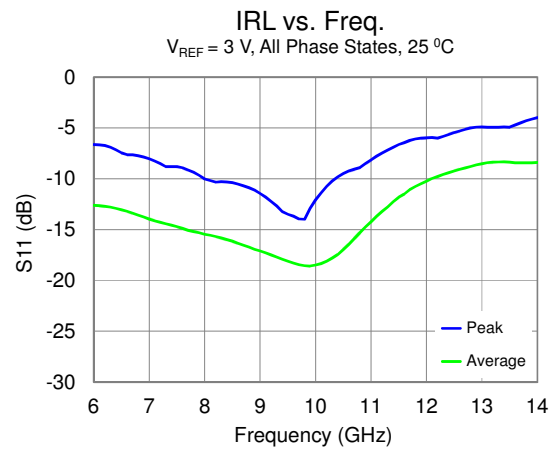
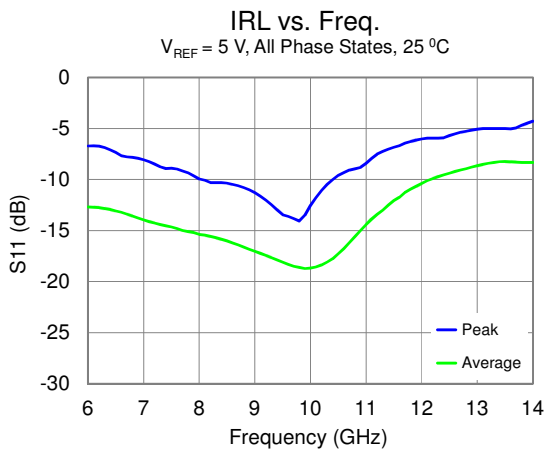
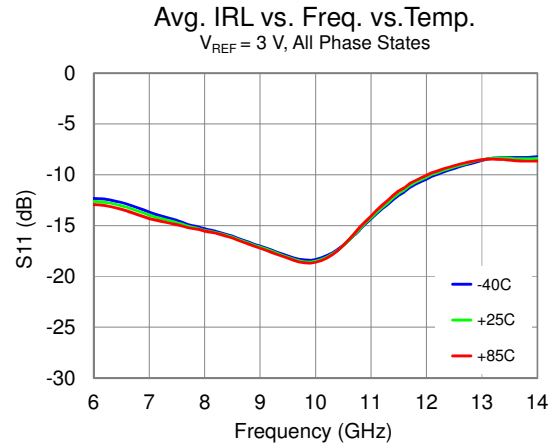
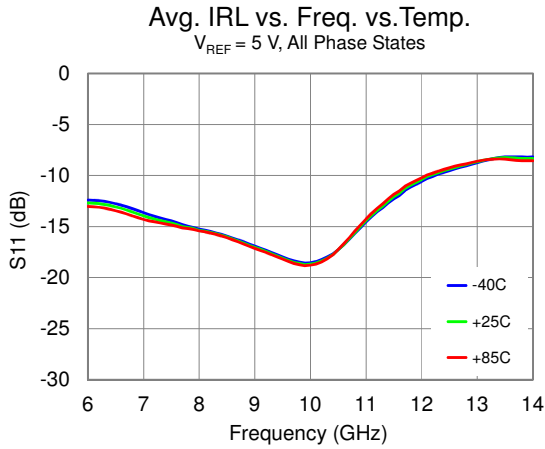

Typical Performance – Small Signal (Cont.)

Test conditions unless otherwise noted: 5V and 3V, 25 °C

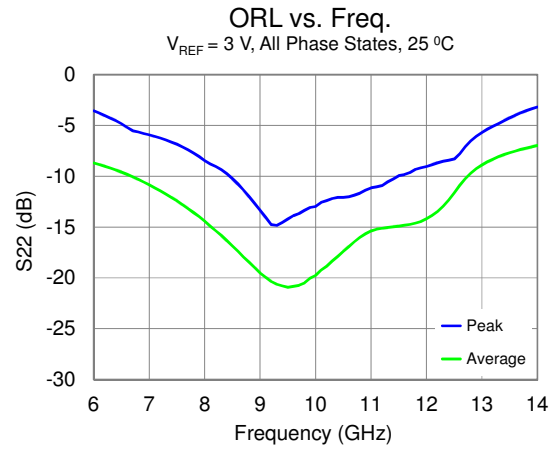
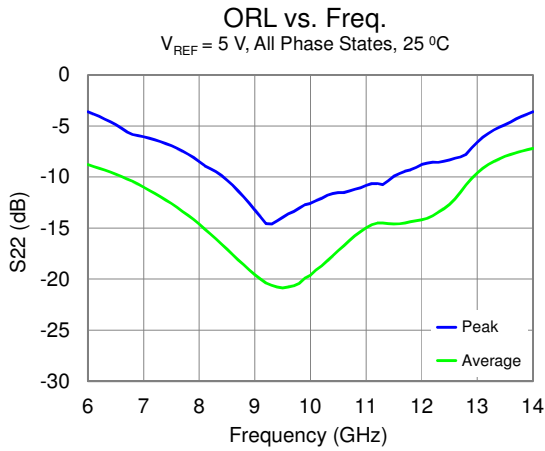

Typical Performance – Large Signal

Test conditions unless otherwise noted: 5V and 3V, 25 °C

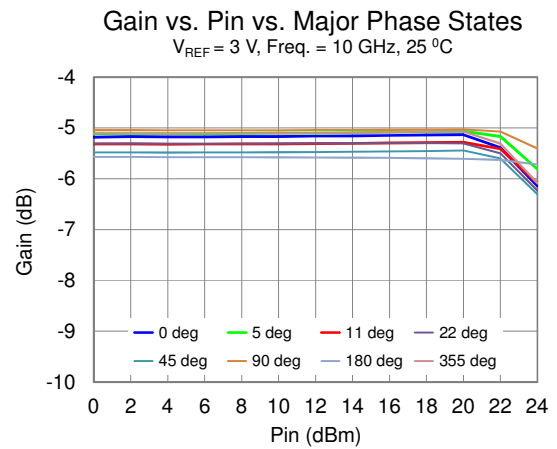
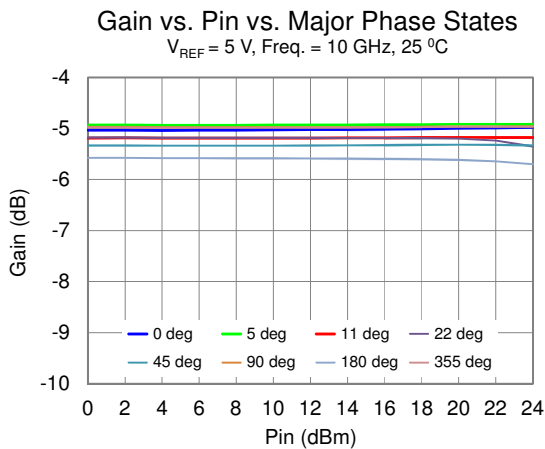
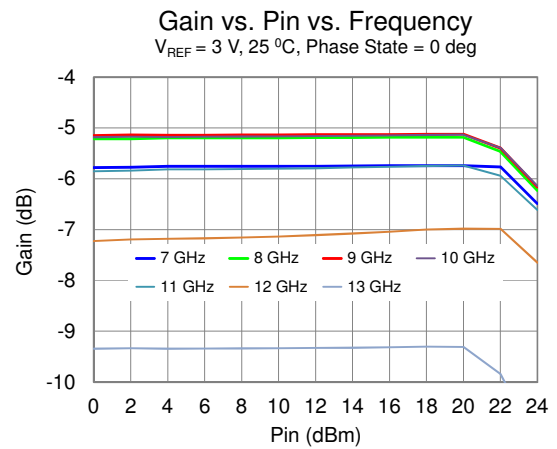
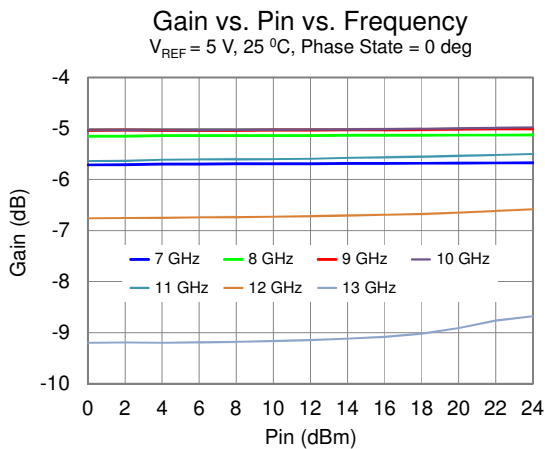
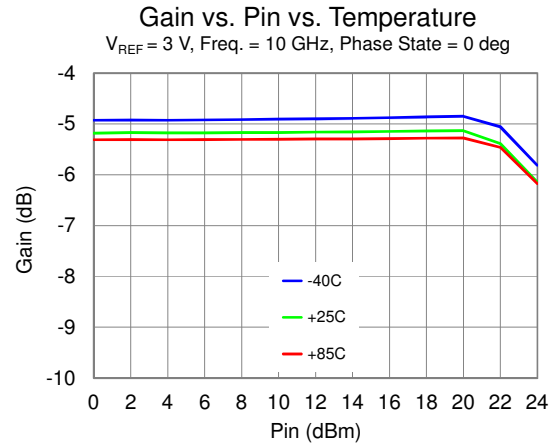
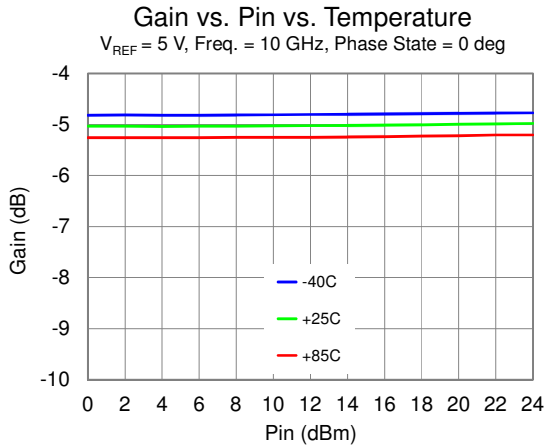

Typical Performance – Large Signal (Cont.)

Test conditions unless otherwise noted: 5V and 3V, 25 °C

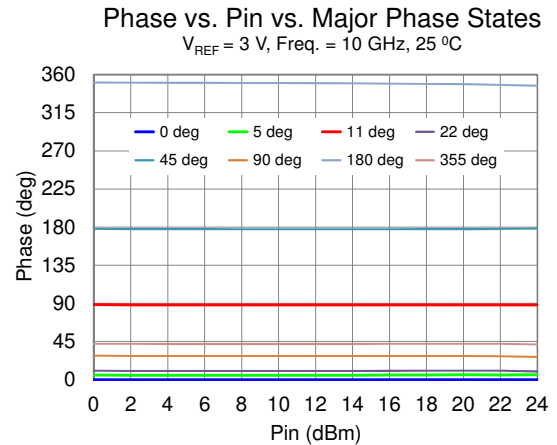
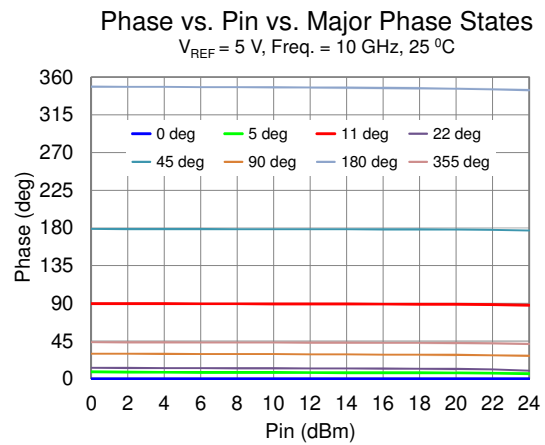
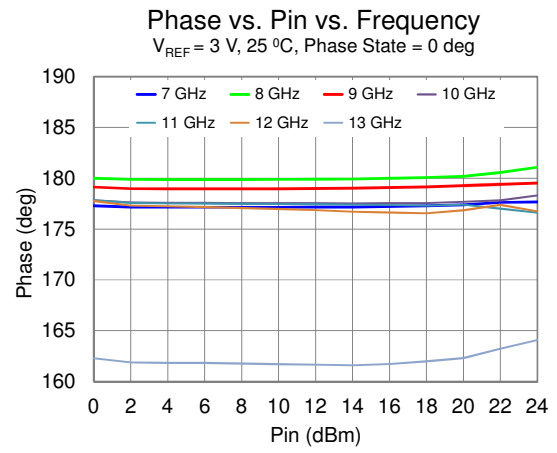
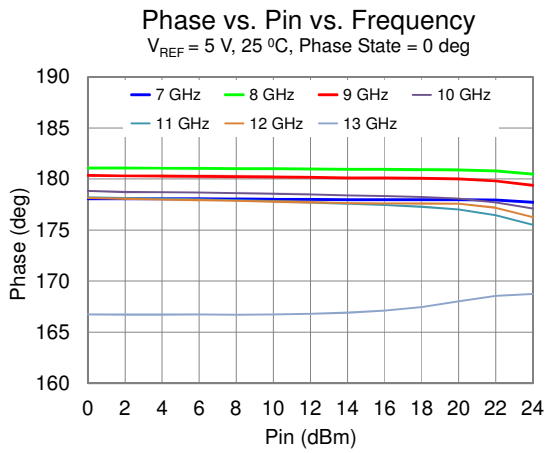
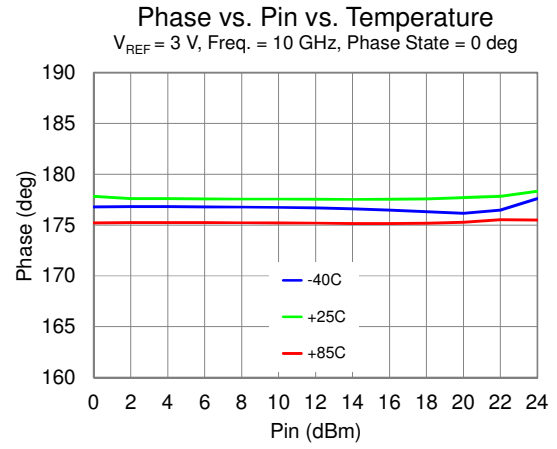
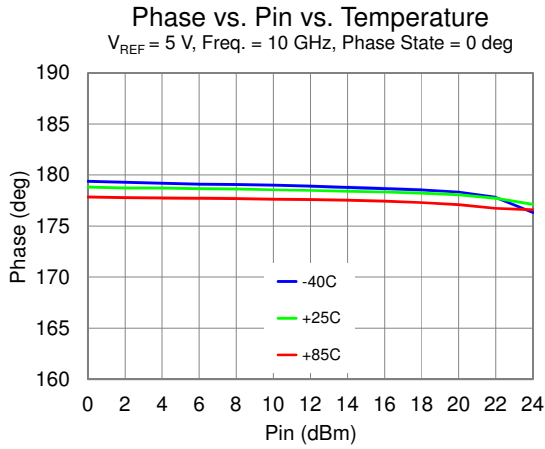

Typical Performance – Large Signal (Cont.)

Test conditions unless otherwise noted: 5V and 3V, 25 °C

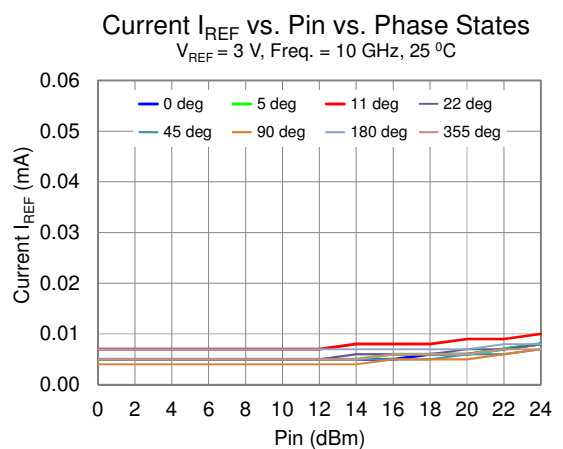
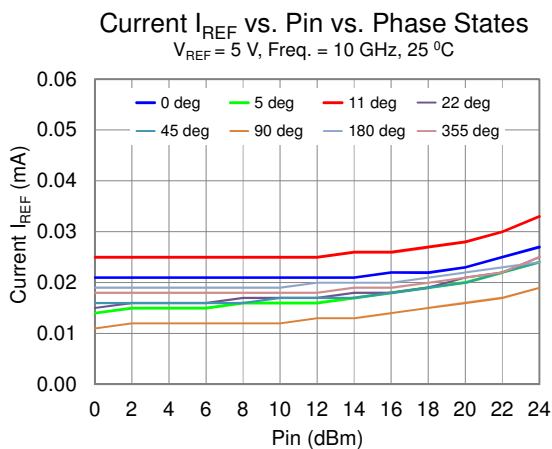
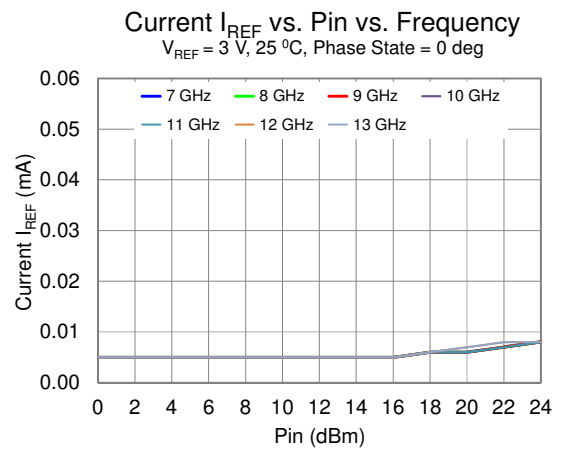
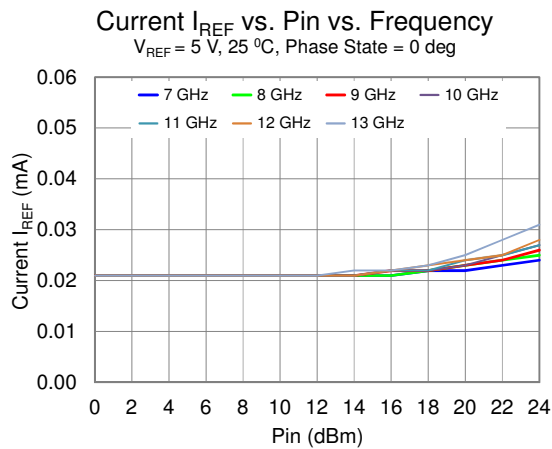
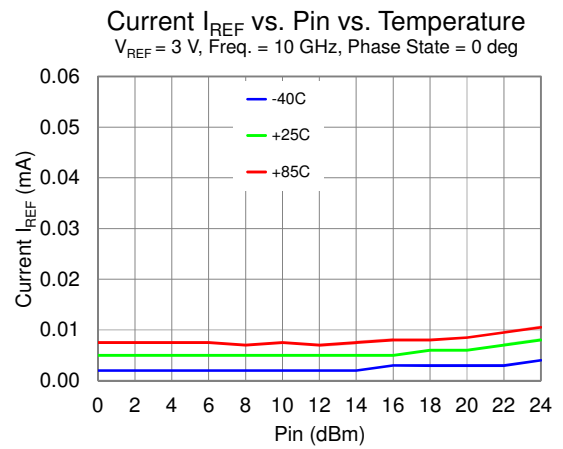
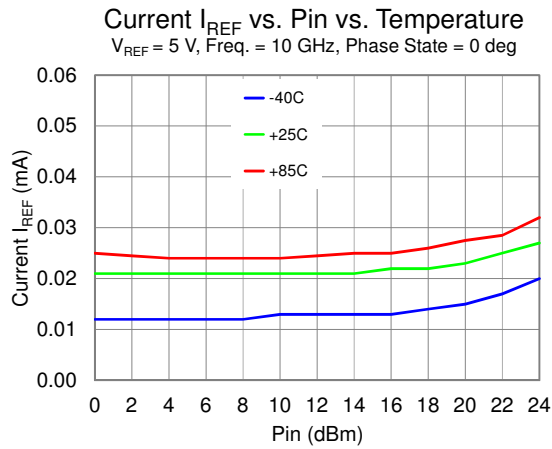

Typical Performance – Linearity

Test conditions unless otherwise noted: 5V and 3V, Tone Spacing = 10 MHz, 25 °C

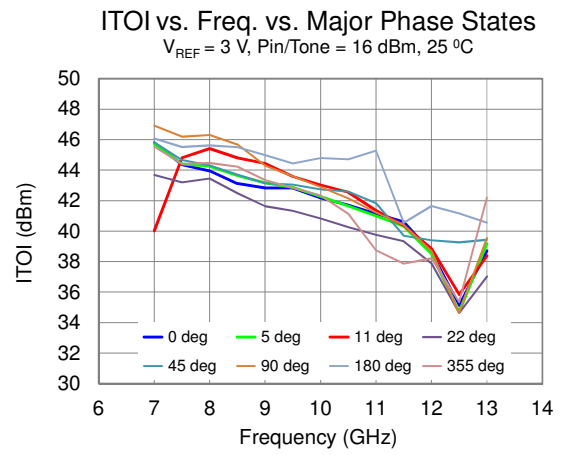
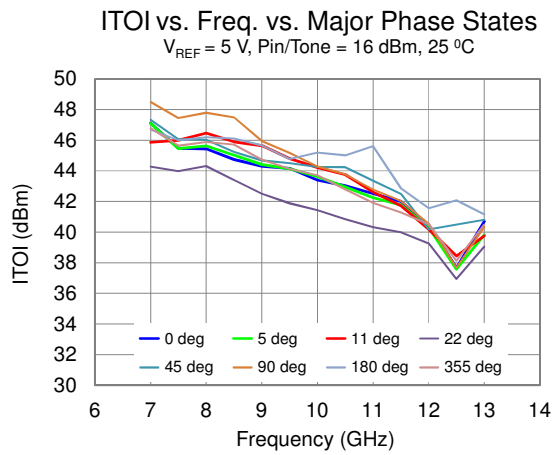
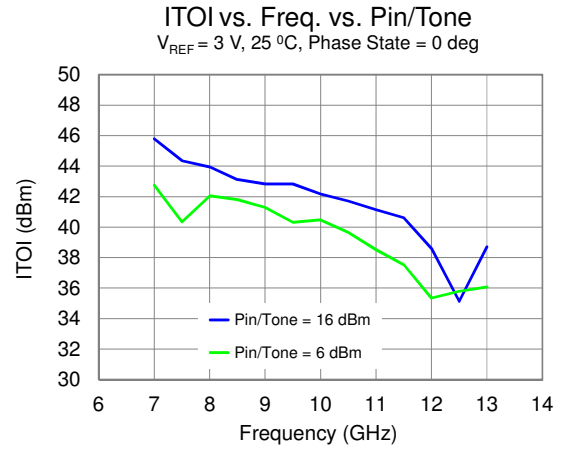
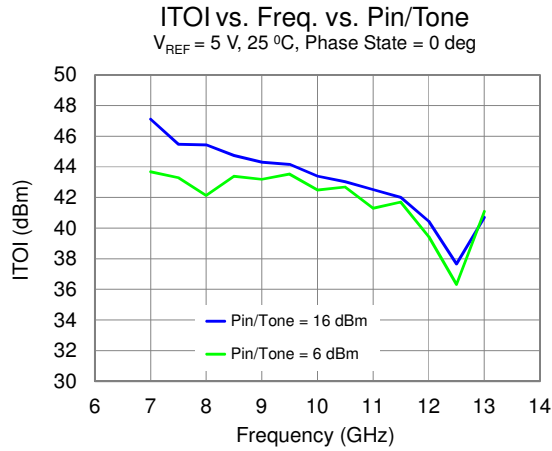

Typical Performance – Linearity (Cont.)

Test conditions unless otherwise noted: 5V and 3V, Tone Spacing = 10 MHz, 25 °C

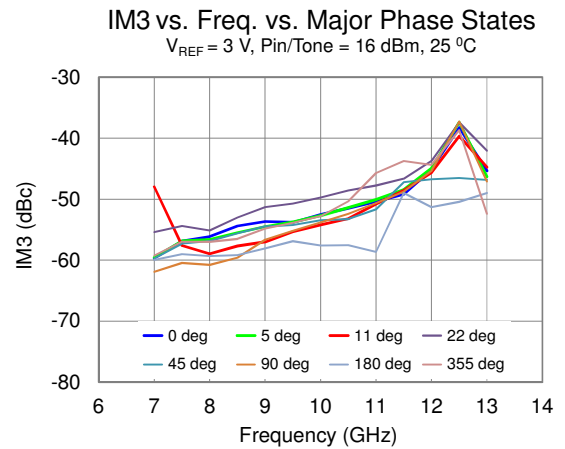
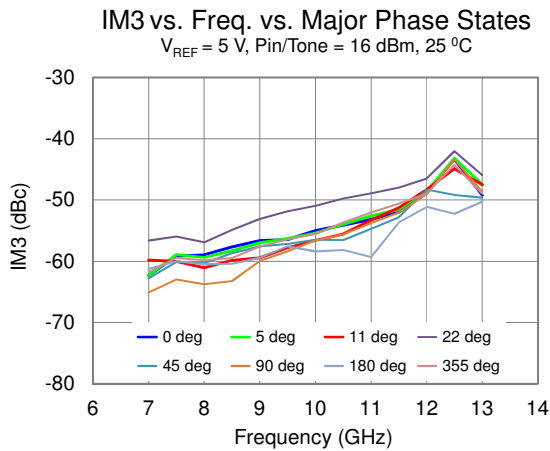
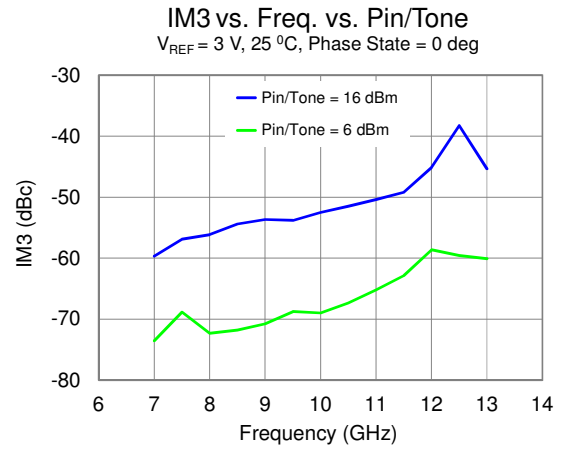
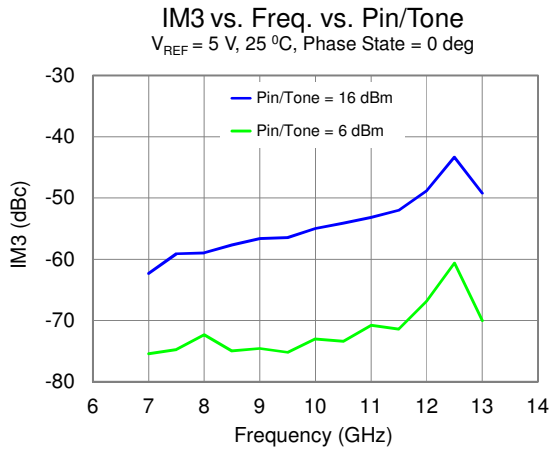

Mechanical Information and Bond Pad Description

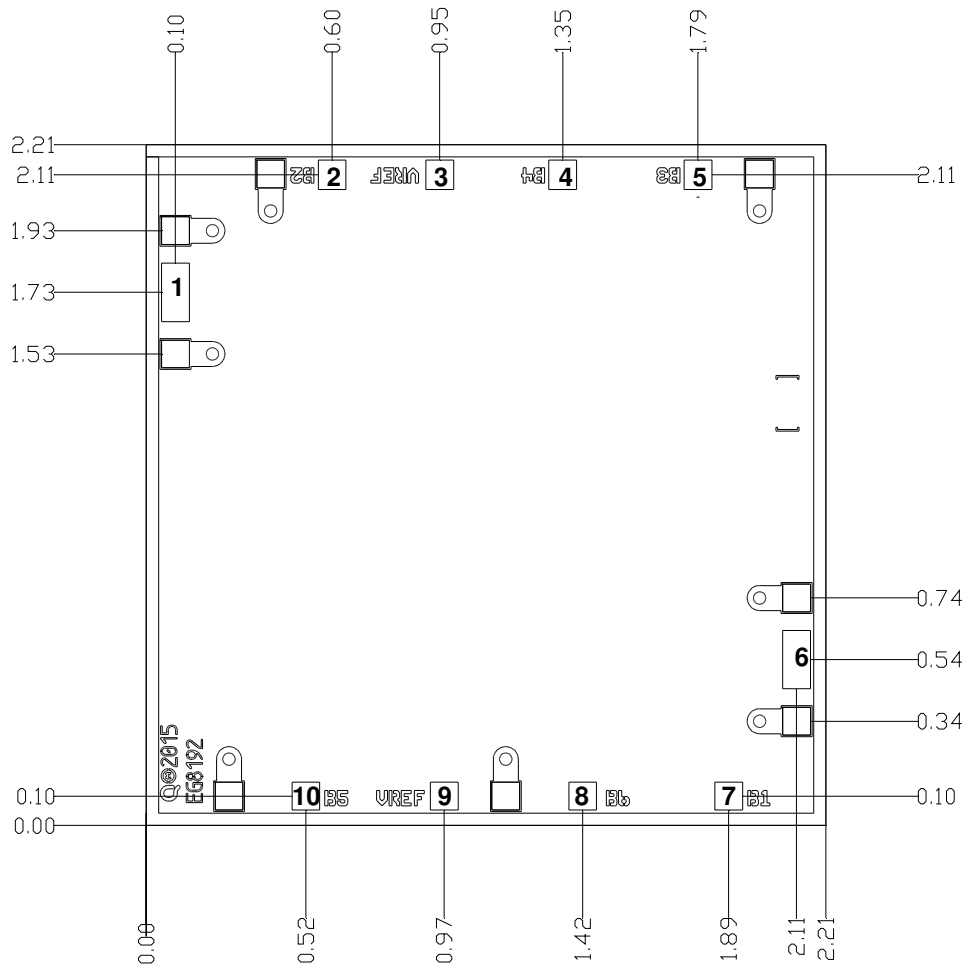

Unit: millimeters
 Thickness: 0.10
 Die x, y size tolerance: ± 0.050
 Chip edge to bond pad dimensions are shown to center of pad
 Ground is backside of die

Bond Pad	Symbol	Description	Pad Size
1	RF In	Input; matched to 50 Ω ; DC blocked; interchangeable to RF Output	0.200 x 0.100
2	11°	11° Bit	0.100 x 0.100
3, 9	REF	Reference; V_{REF} can be applied to either pad	0.100 x 0.100
4	45°	45° Bit	0.100 x 0.100
5	22°	22° Bit	0.100 x 0.100
6	RF Out	Output; matched to 50 Ω ; DC blocked; interchangeable to RF Input	0.200 x 0.100
7	5°	5° Bit	0.100 x 0.100
8	180°	180° Bit	0.100 x 0.100
10	90°	90° Bit	0.100 x 0.100

Applications Information

1. De-Quing network is not required; V_{REF} can be applied to either side of the MMIC (pad # 3 or #9)
2. The spacing between MMIC and TFN at RF In and RF Out is <5 mils typical.
3. RF connections: Bond three 1-mil diameter, <20 mils length gold bond wires at RF In and RF Out for optimum RF performance.

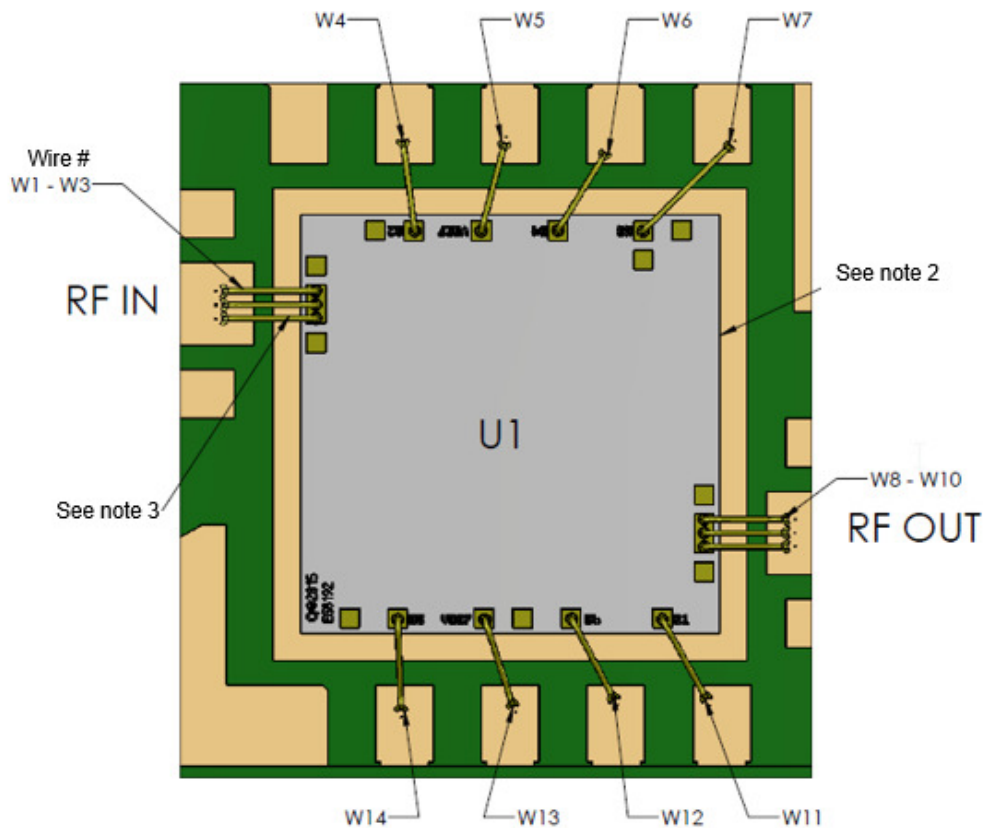
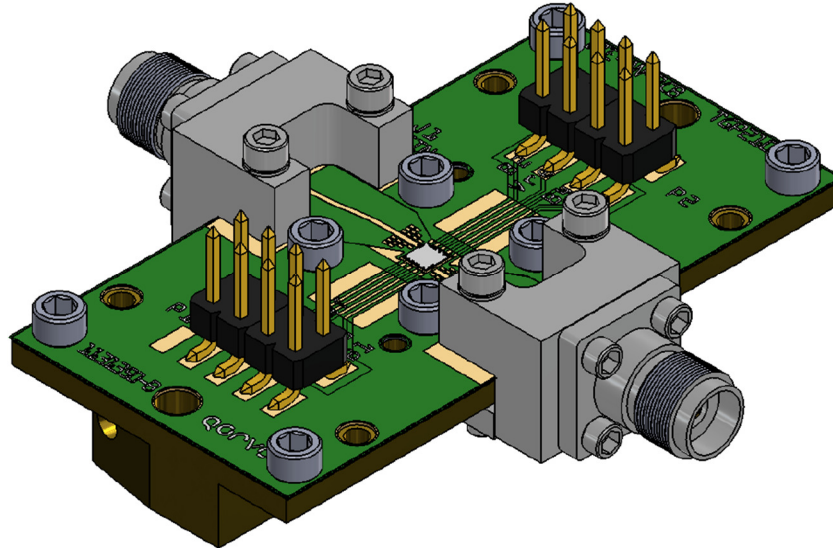

Assembly Notes

Component placement and adhesive attachment assembly notes:

- Vacuum pencils and/or vacuum collets are the preferred method of pick up.
- Air bridges must be avoided during placement.
- The force impact is critical during auto placement.
- Solder or Organic Adhesive attachment can be used for TGL2205.
- Curing should be done in a convection oven; proper exhaust is a safety concern.

Solder attachment reflow process assembly notes:

- Use AuSn (80/20) solder and limit exposure to temperatures above 300°C to 3 to 4 minutes, maximum.
- An alloy station or conveyor furnace with reducing atmosphere should be used.
- Do not use any kind of flux.
- Coefficient of thermal expansion matching is critical for long-term reliability.
- Devices must be stored in a dry nitrogen atmosphere.

Organic adhesive attachment assembly notes:

- The organics such as epoxy or polyimide can be used.
- Epoxies cure at temperatures of 100 to 200°C.

Interconnect process assembly notes:

- Thermosonic ball bonding is the preferred interconnect technique.
- Force, time, and ultrasonics are critical parameters.
- Aluminum wire should not be used.
- Devices with small pad sizes should be bonded with 0.0007-inch wire.

Product Compliance Information

ESD Sensitivity Ratings



Caution! ESD-Sensitive Device

ESD Rating: TBD
Value: TBD
Test: Human Body Model (HBM)
Standard: JEDEC Standard JESD22-A114

Solderability

This part is compliant with EU 2002/95/EC RoHS directive (Restrictions on the Use of Certain Hazardous Substances in Electrical and Electronic Equipment).

This product also has the following attributes:

- Lead Free
- Halogen Free (Chlorine, Bromine)
- Antimony Free
- TBBP-A (C₁₅H₁₂Br₄O₂) Free
- PFOS Free
- SVHC Free

ECCN

US Department of Commerce: EAR99

Contact Information

For the latest specifications, additional product information, worldwide sales and distribution locations, and information about TriQuint:

Web: www.triquint.com Tel: +1.972.994.8465
Email: info-sales@triquint.com Fax: +1.972.994.8504

For technical questions and application information: Email: info-products@triquint.com

Important Notice

The information contained herein is believed to be reliable. TriQuint makes no warranties regarding the information contained herein. TriQuint assumes no responsibility or liability whatsoever for any of the information contained herein. TriQuint assumes no responsibility or liability whatsoever for the use of the information contained herein. The information contained herein is provided "AS IS, WHERE IS" and with all faults, and the entire risk associated with such information is entirely with the user. All information contained herein is subject to change without notice. Customers should obtain and verify the latest relevant information before placing orders for TriQuint products. The information contained herein or any use of such information does not grant, explicitly or implicitly, to any party any patent rights, licenses, or any other intellectual property rights, whether with regard to such information itself or anything described by such information.

TriQuint products are not warranted or authorized for use as critical components in medical, life-saving, or life-sustaining applications, or other applications where a failure would reasonably be expected to cause severe personal injury or death.

Данный компонент на территории Российской Федерации

Вы можете приобрести в компании MosChip.

Для оперативного оформления запроса Вам необходимо перейти по данной ссылке:

<http://moschip.ru/get-element>

Вы можете разместить у нас заказ для любого Вашего проекта, будь то серийное производство или разработка единичного прибора.

В нашем ассортименте представлены ведущие мировые производители активных и пассивных электронных компонентов.

Нашей специализацией является поставка электронной компонентной базы двойного назначения, продукции таких производителей как XILINX, Intel (ex.ALTERA), Vicor, Microchip, Texas Instruments, Analog Devices, Mini-Circuits, Amphenol, Glenair.

Сотрудничество с глобальными дистрибьюторами электронных компонентов, предоставляет возможность заказывать и получать с международных складов практически любой перечень компонентов в оптимальные для Вас сроки.

На всех этапах разработки и производства наши партнеры могут получить квалифицированную поддержку опытных инженеров.

Система менеджмента качества компании отвечает требованиям в соответствии с ГОСТ Р ИСО 9001, ГОСТ РВ 0015-002 и ЭС РД 009

Офис по работе с юридическими лицами:

105318, г.Москва, ул.Щербаковская д.3, офис 1107, 1118, ДЦ «Щербаковский»

Телефон: +7 495 668-12-70 (многоканальный)

Факс: +7 495 668-12-70 (доб.304)

E-mail: info@moschip.ru

Skype отдела продаж:

moschip.ru

moschip.ru_4

moschip.ru_6

moschip.ru_9