

PART NUMBER

10138940-XX

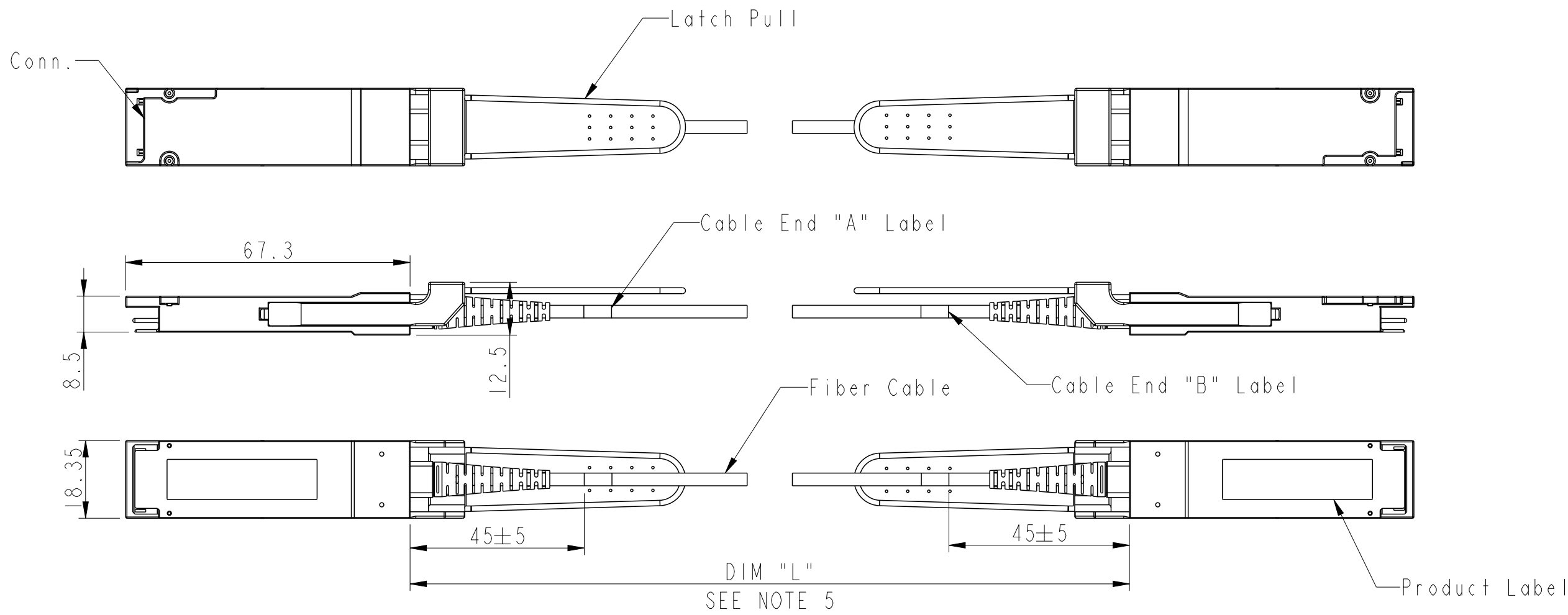

NOTES:

- EEPROM SHALL BE PARTIAL WRITE ENABLED.
- MATERIAL:
 COVERS : ZINC ALLOY/ COPPER UNDERPLATE/ NICKEL OVERPLATE
 PULL TAB :TEAR RESISTANT PLASTIC
 LATCH RELEASE: ZINC ALLOY/ COPPER UNDERPLATE/ NICKEL OVERPLATE
 DRIVE SCREWS: STAINLESS STEEL
 STRAIN RELIEF BOOT : THERMOPLASTIC
 SPRING : STAINLESS STEEL
 PCB: PRINTED CIRCUIT SUBSTRATE-FR4.
 CONTACT AREA: GOLD:0.03UM MIN,PALLADIUM:0.3UM MIN,NICKEL:5UM MIN OVER COPPER
 DUST COVER : POLY ETHYLENE
 FIBER CABLE: WHEN 0<L<=20m, USE OM2 50/125 LSZH FIBER CABLE(ORANGE COLORED JACKET)
 WHEN 20<L<=100m, USE OM3 50/125 LSZH FIBER CABLE(AQUA COLORED JACKET)
 TOP & BOTTOM BLISTER (NOT SHOWN) : PET
- THIS PRODUCT MEETS THE RESTRICTION OF HAZARDOUS SUBSTANCES IN ELECTRICAL AND ELECTRONIC EQUIPMENT (RoHS).DIRECTIVE 2002/95/EC.
- THIS DIMENSION IS A FINISHED PRODUCT LENGTH.
- EACH END OF FIBER CABLE SHOULD MARKED WITH A/B ON SEPARATED LABEL TO DIFFERENTIATE.

PRODUCT NUMBER DESCRIPTION:

10138940 - XX
 LENGTH
 XX= METERS
 EXAMPLE : 0E = 0.5 METERS (DIM "L")
 1E = 1.5 METERS (DIM "L")
 05 = 05 METERS (DIM "L")
 C0 = 100 METERS (DIM "L")

LENGTH TOLERANCE	
<20 M	+5% / 0
>=20 M	+/- 2%

Amphenol FCI

© 2016 AFCI

spec ref	-	dr	Tony Leng	2016/03/03	projection	mm	size	A3	scale	1:1	
tolerance std	ISO 406 ISO 1101	eng	Sun Shine	2016/11/03			ecn no	ELX-N-25266-1			
TOLERANCES UNLESS OTHERWISE SPECIFIED		chr	-	-			rel level	Released			
surface	linear	appr	Wei-Zhong Hu	2016/11/03	product family	-	dwg no	10138940		rev	B
	angular							STRAIGHT BOOT PRODUCT ASSY			
								QSFP+ AOC			
								cat. no. -		Product - Customer Drw	
								sheet 1 of 3			

WIRING TABLE

CONNECTOR SIDE 1

CONNECTOR SIDE 2

GND(TX)	1
TX2n	2
TX2p	3
GND(TX)	4
TX4n	5
TX4p	6
GND(TX)	7
GND(RX)	13
RX3p	14
RX3n	15
GND(RX)	16
RX1p	17
RX1n	18
GND(RX)	19
GND(RX)	20
RX2n	21
RX2p	22
GND(RX)	23
RX4n	24
RX4p	25
GND(RX)	26
GND(TX)	32
TX3p	33
TX3n	34
GND(TX)	35
TX1p	36
TX1n	37
GND(TX)	38

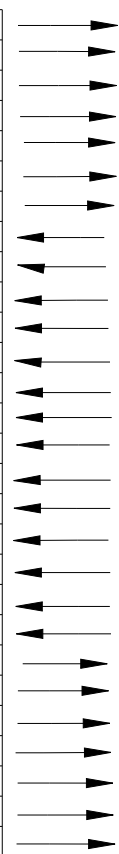

GND(RX)	20
RX2n	21
RX2p	22
GND(RX)	23
RX4n	24
RX4p	25
GND(RX)	26
GND(TX)	32
TX3p	33
TX3n	34
GND(TX)	35
TX1p	36
TX1n	37
GND(TX)	38
GND(TX)	1
TX2n	2
TX2p	3
GND(TX)	4
TX4n	5
TX4p	6
GND(TX)	7
GND(RX)	13
RX3p	14
RX3n	15
GND(RX)	16
RX1p	17
RX1n	18
GND(RX)	19

CABLE END LABEL

LOW SPEED SIGNALS	
SIDE 1 AND SIDE 2	
8	ModSel1
9	Reset1
10	VccRx
11	SCL
12	SDA
27	ModPrs1
28	Int1
29	VccTx
30	Vcc1
31	LPMODE

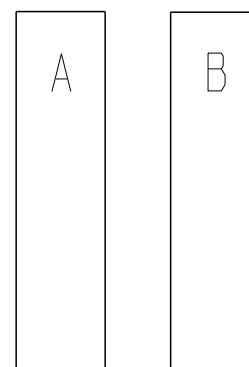

PRODUCT LABEL

FCI 10138940-XX
 GNYWW-XXXXX
 Made in China, YYWW
 Class I Laser 21 CFR 1040.10 & 1040.11 **CE**

SN CODE (DATA MATRIX)
 FCI PN:Tahoma,Bold,Size 4.5
 SN:Tahoma,Bold,Size 4.5
 YY:2016--->16,2017--->17...
 WW:WEEK OF THE YEAR
 A0001~A9999 STANDS FOR SIDE "A"
 B0001~B9999 STANDS FOR SIDE "B"
 FONT:Tahoma,Size 4.0
 FONT:Tahoma,size:4.0

Amphenol FCI

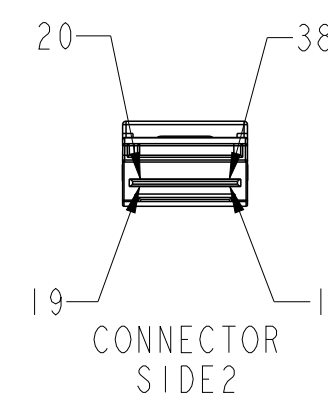
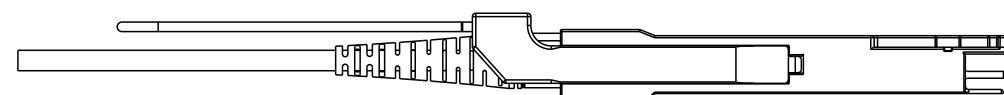
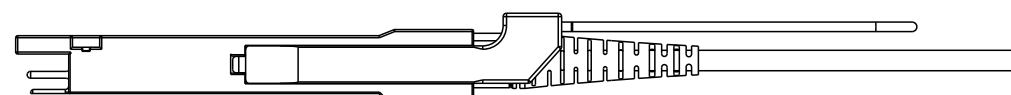
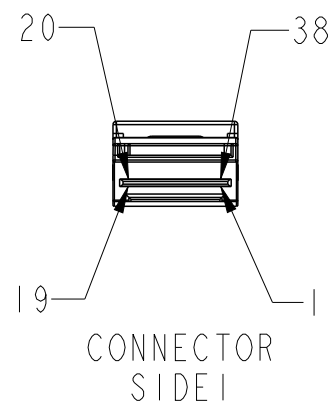

spec ref	-	dr	Tony Leng	2016/03/03	projection	mm	size	A3	scale	1:1	
tolerance std	ISO 406 ISO 1101	eng	Sun Shine	2016/11/03			ecn no	ELX-N-25266-1			
TOLERANCES UNLESS OTHERWISE SPECIFIED		chr	-	rel level				Released			
surface	linear	appr	Wei-Zhong Hu	2016/11/03	product family	-	dwg no	10138940		rev	B
	angular	Amphenol FCI STRAIGHT BOOT PRODUCT ASSY QSFP+ AOC		cat. no.	-	Product - Customer Drw	sheet 2 of 3				
		0.X	±0.3								
		0.XX	±0.10								
		0.XXX	±0.005								
		0°	±2°								

TRAY LABEL



QSFP+ AOC QTY=1

PN: 10138940-XX



SN: GNYYWW-CXXXX



Made in China

Class I Laser Product
21 CFR 1040.10 & 1040.11
IEC 60825-1:2007



FONT:Tahoma,Size 9
 PRODUCT DESCRIPTION
 Tahoma,Bold,Size 9
 PN:Tahoma,Bold,Size 9

 SN:Tahoma,Bold,Size 9
 YY:2016--->16,2017--->17...
 WW:WEEK OF THE YEAR
 CXXXX:C0001~C9999

MANUFACTURING PLACE
 Tahoma,Size 9

FONT:Tahoma,SIZE:6

CARTON LABEL



QSFP+ AOC QTY=X

PN: 10138940-XX



Made in China

Class I Laser Product
21 CFR 1040.10 & 1040.11
IEC 60825-1:2007



FONT:Tahoma,Size 9
 PRODUCT DESCRIPTION
 Tahoma,Bold,Size 9
 PN:Tahoma,Bold,Size 9

MANUFACTURING PLACE
 Tahoma,Size 9

FONT:Tahoma,SIZE:6

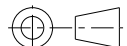
spec ref	-	dr	Tony Leng	2016/03/03	projection	mm	size	A3	scale	1:1
tolerance std	ISO 406 ISO 1101	eng	Sun Shine	2016/11/03		← →	ecn no	ELX-N-25266-1		
TOLERANCES UNLESS OTHERWISE SPECIFIED		chr	-	-			product family	-	rel level	Released
surface	linear	appr	Wei-Zhong Hu	2016/11/03	Amphenol FCI		STRAIGHT BOOT PRODUCT ASSY	10138940	rev	B
	angular				cat. no.	-	Product - Customer Drw	sheet 3 of 3		

Данный компонент на территории Российской Федерации

Вы можете приобрести в компании MosChip.

Для оперативного оформления запроса Вам необходимо перейти по данной ссылке:

<http://moschip.ru/get-element>

Вы можете разместить у нас заказ для любого Вашего проекта, будь то серийное производство или разработка единичного прибора.

В нашем ассортименте представлены ведущие мировые производители активных и пассивных электронных компонентов.

Нашей специализацией является поставка электронной компонентной базы двойного назначения, продукции таких производителей как XILINX, Intel (ex.ALTERA), Vicor, Microchip, Texas Instruments, Analog Devices, Mini-Circuits, Amphenol, Glenair.

Сотрудничество с глобальными дистрибьюторами электронных компонентов, предоставляет возможность заказывать и получать с международных складов практически любой перечень компонентов в оптимальные для Вас сроки.

На всех этапах разработки и производства наши партнеры могут получить квалифицированную поддержку опытных инженеров.

Система менеджмента качества компании отвечает требованиям в соответствии с ГОСТ Р ИСО 9001, ГОСТ РВ 0015-002 и ЭС РД 009

Офис по работе с юридическими лицами:

105318, г.Москва, ул.Щербаковская д.3, офис 1107, 1118, ДЦ «Щербаковский»

Телефон: +7 495 668-12-70 (многоканальный)

Факс: +7 495 668-12-70 (доб.304)

E-mail: info@moschip.ru

Skype отдела продаж:

moschip.ru

moschip.ru_4

moschip.ru_6

moschip.ru_9