

One Piece Top Entry Card Edge



Series 00-9159



AVX continues to develop unique connectors to fill the gap in the industrial market, specifically as it relates to low pin count requirements. The newest addition to AVX's broadening line of one piece card edge connectors is the 2p-6p top entry version which complements the bottom entry version released last year. This new configuration will allow small perpendicular daughter cards to be plugged in from the top side of the main board. The single connector option offers an alternative to the more traditional and costly two piece solution.

This small connector is packed with several key features that provide significant functionality in a broad range of robust industrial applications. The contact system is gold plated for enhanced reliability, signal integrity and full 2A/contact current rating. The PCB board opening is dual slotted to accept either a 0.8mm or 1.6mm thick daughter card within the same connector body.

APPLICATIONS

- Provides a one piece connector solution for low pin count perpendicular PCB mating in industrial applications
- Facilitates easy plug ability for small module/programming cards

FEATURES AND BENEFITS

- 2 Amp per contact current rating meets robust industrial application requirements
- Removable pick and place cap supports robotic placement and SMT termination
- Gold plated BeCu contact system for high reliability in harsh environments
- Accepts both 0.8mm and 1.6mm PCB's for added design options

ELECTRICAL

- Current Rating: 2 Amps / Contact
- Voltage Rating: 250 VAC

ENVIRONMENTAL

- Operating Temperature: -40°C to +120°C

MECHANICAL

- Insulator Material: Nylon UL94VO
- Contact Material: Beryllium Copper
- Plating: Gold / Tin over Nickel
- Durability 10 Cycles

HOW TO ORDER

00
Prefix

9159
Series

00X
Number of Ways

Code	No of Ways	Details
002	2	Page 2
003	3	Page 3
004	4	Page 4
005	5	Page 5
006	6	Page 6

551
Single Part PCB Strip Connector
551 = Top Mounting on Board

X
Insulator Color

Code	Color	Application
9	White	UL Approved Standard

06
Plating Option
06 = Gold Plating on Nose with Tin on Tails

Certification: UL File #E90723



One Piece Top Entry Card Edge



Series 00-9159

2 WAY TOP MOUNTING EDGE CARD CONNECTOR



SECTION A-A



SUGGESTED PCB LAYOUT

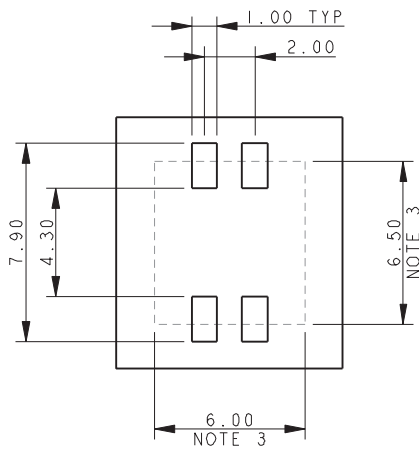

PICK AND PLACE CAP



PACKING DETAILS

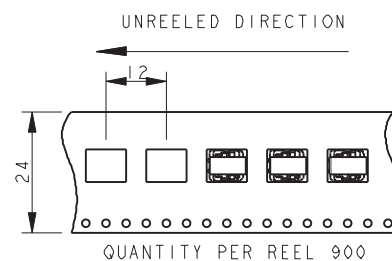

NOTES:

- 5159-500 SERIES TOP MOUNTING EDGE CARD CONNECTOR, 2 WAY. FOR FURTHER DETAILS REFER TO PRODUCT SPECIFICATION 201-01-136 AND APPLICATION NOTES 201-01-137.
- FOR MATING PCB EITHER 0.8MM OR 1.6MM THICK PCB. (DETAILS SAME AS 9159-500), REFER TO PAGE 7.
- CONNECTOR OUTLINE.
- ALL DIMENSIONS ± 0.20 UNLESS TOLERANCE SPECIFIED.
- INSULATOR: PA4T, GLASS FILLED, HALOGEN FREE, UL94 V-0, COLOR REFER TO PAGE 1.
- CONTACT: COPPER ALLOY, NICKEL PLATED WITH GOLD FLASH ON NOSE AND TIN ON TAILS.
- BRACKET; COPPER ALLOY, PLATING, TIN OVER NICKEL.
- PACKING IN TAPE AND REEL, 900 PIECES PER REEL.
- CONTACT TAILS COPLANARITY WITHIN 0.10.



One Piece Top Entry Card Edge



Series 00-9159

3 WAY TOP MOUNTING EDGE CARD CONNECTOR



SUGGESTED PCB LAYOUT

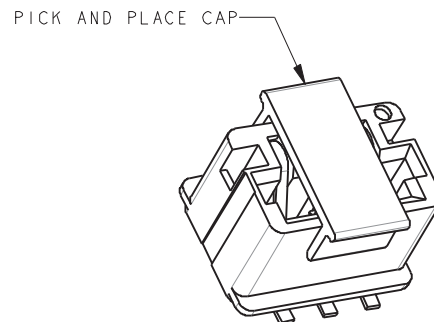

PACKING DETAILS

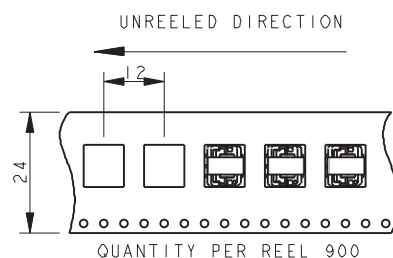

NOTES:

1. 5159-500 SERIES TOP MOUNTING EDGE CARD CONNECTOR, 3 WAY. FOR FURTHER DETAILS REFER TO PRODUCT SPECIFICATION 201-01-136 AND APPLICATION NOTES 201-01-137.
2. FOR MATING PCB EITHER 0.8MM OR 1.6MM THICK PCB. (DETAILS SAME AS 9159-500), REFER TO PAGE 7.
3. CONNECTOR OUTLINE.
4. ALL DIMENSIONS ± 0.20 UNLESS TOLERANCE SPECIFIED.
5. INSULATOR: PA4T, GLASS FILLED, HALOGEN FREE, UL94 V-0, COLOR REFER TO PAGE 1.
6. CONTACT: COPPER ALLOY, NICKEL PLATED WITH GOLD FLASH ON NOSE AND TIN ON TAILS.
7. BRACKET; COPPER ALLOY, PLATING, TIN OVER NICKEL.
8. PACKING IN TAPE AND REEL, 900 PIECES PER REEL.
9. CONTACT TAILS COPLINARITY WITHIN 0.10.



One Piece Top Entry Card Edge



Series 00-9159

4 WAY TOP MOUNTING EDGE CARD CONNECTOR

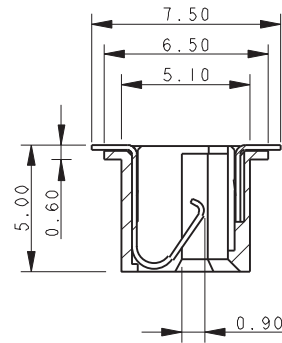

SECTION A-A



SUGGESTED PCB LAYOUT



PICK AND PLACE CAP



PACKING DETAILS



UNREEL DIRECTION

UNREEL DIRECTION



QUANTITY PER REEL 900

NOTES:

1. 5159-500 SERIES TOP MOUNTING EDGE CARD CONNECTOR, 4 WAY. FOR FURTHER DETAILS REFER TO PRODUCT SPECIFICATION 201-01-136 AND APPLICATION NOTES 201-01-137.
2. FOR MATING PCB EITHER 0.8MM OR 1.6MM THICK PCB. (DETAILS SAME AS 9159-500), REFER TO PAGE 7.
3. CONNECTOR OUTLINE.
4. ALL DIMENSIONS ± 0.20 UNLESS TOLERANCE SPECIFIED.
5. INSULATOR: PA4T, GLASS FILLED, HALOGEN FREE, UL94 V-0, COLOR REFER TO PAGE 1.
6. CONTACT: COPPER ALLOY, NICKEL PLATED WITH GOLD FLASH ON NOSE AND TIN ON TAILS.
7. BRACKET; COPPER ALLOY, PLATING, TIN OVER NICKEL.
8. PACKING IN TAPE AND REEL, 900 PIECES PER REEL.
9. CONTACT TAILS COPLANARITY WITHIN 0.10.



One Piece Top Entry Card Edge



Series 00-9159

5 WAY TOP MOUNTING EDGE CARD CONNECTOR



SECTION A-A

SUGGESTED PCB LAYOUT



PICK AND PLACE CAP

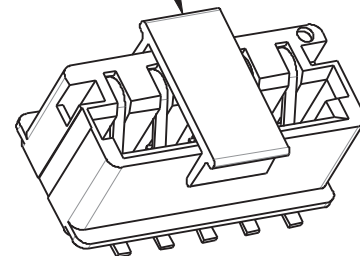

PACKING DETAILS



QUANTITY PER REEL 900

NOTES:

1. 5159-500 SERIES TOP MOUNTING EDGE CARD CONNECTOR, 5 WAY. FOR FURTHER DETAILS REFER TO PRODUCT SPECIFICATION 201-01-136 AND APPLICATION NOTES 201-01-137.
2. FOR MATING PCB EITHER 0.8MM OR 1.6MM THICK PCB. (DETAILS SAME AS 9159-500), REFER TO PAGE 7.
3. CONNECTOR OUTLINE.
4. ALL DIMENSIONS ± 0.20 UNLESS TOLERANCE SPECIFIED.
5. INSULATOR: PA4T, GLASS FILLED, HALOGEN FREE, UL94 V-0, COLOR REFER TO PAGE 1.
6. CONTACT: COPPER ALLOY, NICKEL PLATED WITH GOLD FLASH ON NOSE AND TIN ON TAILS.
7. BRACKET; COPPER ALLOY, PLATING, TIN OVER NICKEL.
8. PACKING IN TAPE AND REEL, 900 PIECES PER REEL.
9. CONTACT TAILS COPLINARITY WITHIN 0.10.



One Piece Top Entry Card Edge



Series 00-9159

6 WAY TOP MOUNTING EDGE CARD CONNECTOR



SECTION A-A



SUGGESTED PCB LAYOUT



PICK AND PLACE CAP



PACKING DETAILS

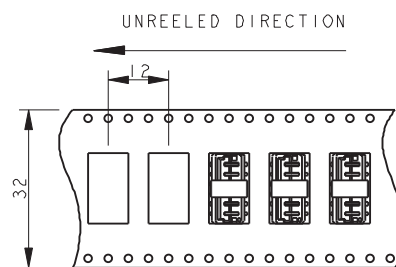
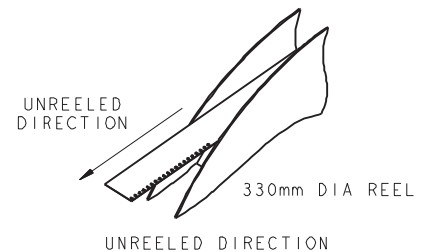

QUANTITY PER REEL 900

NOTES:

1. 5159-500 SERIES TOP MOUNTING EDGE CARD CONNECTOR, 6 WAY. FOR FURTHER DETAILS REFER TO PRODUCT SPECIFICATION 201-01-136 AND APPLICATION NOTES 201-01-137.
2. FOR MATING PCB EITHER 0.8MM OR 1.6MM THICK PCB. (DETAILS SAME AS 9159-500), REFER TO PAGE 7.
3. CONNECTOR OUTLINE.
4. ALL DIMENSIONS ± 0.20 UNLESS TOLERANCE SPECIFIED.
5. INSULATOR: PA4T, GLASS FILLED, HALOGEN FREE, UL94 V-0, COLOR REFER TO PAGE 1.
6. CONTACT: COPPER ALLOY, NICKEL PLATED WITH GOLD FLASH ON NOSE AND TIN ON TAILS.
7. BRACKET; COPPER ALLOY, PLATING, TIN OVER NICKEL.
8. PACKING IN TAPE AND REEL, 900 PIECES PER REEL.
9. CONTACT TAILS COPLANARITY WITHIN 0.10.



One Piece Top Entry Card Edge



Series 00-9159

TOP MOUNTING EDGE CARD CONNECTOR – MATING PCB

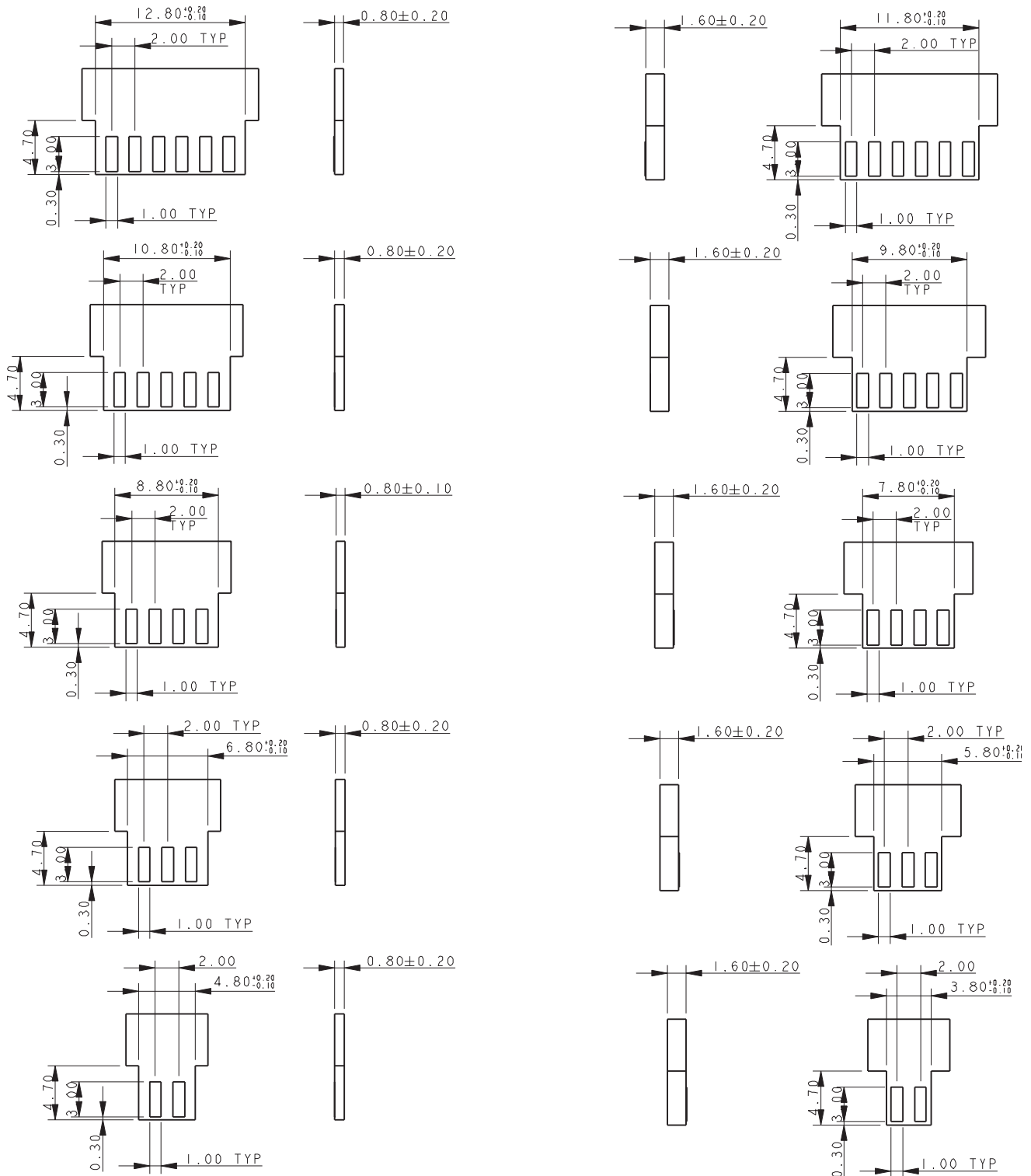

NOTES:

1. CORRECT DIMENSION FOR EITHER 0.80MM OR 1.60MM PCB THICKNESS MUST BE USED.
2. THICKNESS OF PCB INCLUDES ALL LAYERS INCLUDING COPPER AND PLATING.
3. PADS TO BE PLATED GOLD OVER NICKEL UNDERCOAT.
4. GENERAL TOLERANCE ±0.10 UNLESS STATED.



One Piece Top Entry Card Edge



Series 00-9159

TOP MOUNTING EDGE CARD CONNECTOR ASSEMBLY



NOTES:

1. 9159-500 SERIES TOP MOUNTING EDGE CARD CONNECTOR.
2. FOR MATING PCB EITHER 0.8MM OR 1.6MM THICK. REFER TO PAGE 6 FOR MATING PCB DETAILS.
3. CONNECTOR SURFACE MOUNTING ON PCB.
4. PAD DETAILS ON THE MATING PCB ALLOW CONTACT TO BE MADE IN ANY POSITION FORM THE STOP FACE UP TO 1MM FROM THE STOP FACE.
5. GENERAL TOLERANCE ± 0.20 UNLESS STATED.

Данный компонент на территории Российской Федерации

Вы можете приобрести в компании MosChip.

Для оперативного оформления запроса Вам необходимо перейти по данной ссылке:

<http://moschip.ru/get-element>

Вы можете разместить у нас заказ для любого Вашего проекта, будь то серийное производство или разработка единичного прибора.

В нашем ассортименте представлены ведущие мировые производители активных и пассивных электронных компонентов.

Нашей специализацией является поставка электронной компонентной базы двойного назначения, продукции таких производителей как XILINX, Intel (ex.ALTERA), Vicor, Microchip, Texas Instruments, Analog Devices, Mini-Circuits, Amphenol, Glenair.

Сотрудничество с глобальными дистрибьюторами электронных компонентов, предоставляет возможность заказывать и получать с международных складов практически любой перечень компонентов в оптимальные для Вас сроки.

На всех этапах разработки и производства наши партнеры могут получить квалифицированную поддержку опытных инженеров.

Система менеджмента качества компании отвечает требованиям в соответствии с ГОСТ Р ИСО 9001, ГОСТ РВ 0015-002 и ЭС РД 009

Офис по работе с юридическими лицами:

105318, г.Москва, ул.Щербаковская д.3, офис 1107, 1118, ДЦ «Щербаковский»

Телефон: +7 495 668-12-70 (многоканальный)

Факс: +7 495 668-12-70 (доб.304)

E-mail: info@moschip.ru

Skype отдела продаж:

moschip.ru

moschip.ru_4

moschip.ru_6

moschip.ru_9