

# Coin Cells

## Introduction

Since 1982, when RENATA launched the industrial production of lithium batteries, the range of applications has grown continuously. In addition to the wide spectrum of memory backup power sources, RENATA lithium batteries are used for different applications in the computer and automotive industries, telecommunications, medical industry and in an increasing number of portable devices (measuring equipment, payment systems, toys etc.).

RENATA lithium batteries meet the highest quality standards and offer excellent reliability.

### **Advantages**

- Nominal voltage of 3V, approx. twice the voltage level of alkaline button cells
- Wide operating temperature range depending on battery model
- Low self discharge of less than 1% per year at 23°C
- Best practical capacity/volume ratio
- Superior leakage resistance
- Excellent storage characteristics, up to 10 years storage with minimum deterioration
- Safe products: all Renata and MFR coin cells are UL-recognized products (File No. MH14002)
- Environmental-friendly, do not contain toxic substances
- No air transport restrictions (non hazardous)
- Available in a wide range of solder contact configurations or in combination with our battery holders

# Coin Cells

## Standard bare coin cells

### General characteristics

- Self-discharge: less than 1% per year at 23°C
- Shelf life: up to 10 years at max. 23°C
- Stable voltage during shelf life
- High reliability of operation, including leakage resistance
- Contains no heavy metals



### Dimensions and weights

Model	Max. Dimensions (mm)				approx Weight (g)	Part.No.*
	A	B	C	D		
CR1025	10.00	2.50	Ref. 6.0	min 0.08	0.6	700263
CR1216 MFR	12.50	1.60	Ref. 10.2	min 0.05	0.7	100551
CR1220 MFR	12.50	2.00	Ref. 10.3	min 0.10	0.8	100552
CR1225	12.50	2.50	Ref. 9.0	min 0.08	0.9	700281
CR1616	16.00	1.60	Ref. 12.0	min 0.02	1.1	700287
CR1620	16.00	2.00	Ref. 12.0	min 0.06	1.2	700291
CR1632	16.00	3.20	Ref. 12.0	min 0.08	1.8	700296
CR2016 MFR	20.00	1.60	Ref. 18.0	min 0.05	1.7	100270
CR2025 MFR	20.00	2.50	Ref. 17.0	min 0.05	2.5	100271
CR2032 MFR	20.00	3.20	Ref. 17.0	min 0.05	2.8	100272
CR2320	23.00	2.00	Ref. 18.0	min 0.06	2.7	700344
CR2325	23.00	2.50	Ref. 19.0	min 0.08	3.0	700348
CR2430 MFR	24.50	3.00	Ref. 20.0	min 0.08	4.3	100350
CR2430	24.50	3.00	Ref. 20.0	min 0.08	4.1	700359
CR2450N	24.50	5.00	Ref. 22.3	min 2.50	5.9	700377
CR2477N	24.50	7.70	Ref. 22.4	min 5.30	8.3	700391

\*Packaging: Industrial Bulk (IB-Trays)



### Electrical characteristics

Model	Nominal capacity (mAh)	Standard discharge current (mA) <sup>1)</sup>	Max. continuous discharge current (mA) <sup>2)</sup>	Operating Temperature (C) <sup>3)</sup>
CR1025	30	0.05	0.40	-40/+85°
CR1216 MFR	30	0.10	1.00	-30/+70°
CR1220 MFR	40	0.10	1.00	-30/+70°
CR1225	48	0.10	1.00	-40/+85°
CR1616	50	0.10	1.00	-40/+85°
CR1620	68	0.10	1.00	-40/+85°
CR1632	125	0.20	1.50	-40/+85°
CR2016 MFR	90	0.20	3.00	-30/+70°
CR2025 MFR	165	0.30	3.00	-30/+70°
CR2032 MFR	225	0.40	3.00	-30/+70°
CR2320	150	0.20	3.00	-40/+85°
CR2325	190	0.30	3.00	-40/+85°
CR2430 MFR	300	0.50	4.00	-30/+70°
CR2430	285	0.50	4.00	-40/+85°
CR2450N	540	0.80	3.00	-40/+85°
CR2477N	950	1.00	2.50	-40/+85°

1) Standard discharge current: 100% of nominal capacity is obtained by discharging the cells at this current rates.

2) The maximum current is determined for a yield of 70% of the nominal capacity with a cut-off voltage of 2.0V, at 23°C. For currents exceeding those given above or pulsed current, please contact Renata.

3) In applications where the battery is exposed to temperatures above 70°C, please contact Renata for consultancy.

# Coin Cells

## Standard bare coin cells

**CR1025** Rated capacity: 30 mAh  
Average weight: 0.6 g



Discharge performance at 23°C



Discharge performance at 23°C



Temperature performance Load 47 kΩ



Cell capacity at various loads



**CR1216 MFR** Rated capacity: 30 mAh  
Average weight: 0.7 g



Discharge performance at 23°C

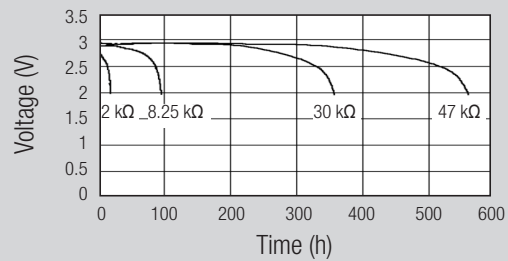

Discharge performance at 23°C



Temperature performance Load 47 kΩ



Cell capacity at various loads





**CR1220 MFR**  Rated capacity: 40 mAh  
Average weight: 0.8 g

**CR1225**  Rated capacity: 48 mAh  
Average weight: 0.9 g



Discharge performance at 23°C



Discharge performance at 23°C

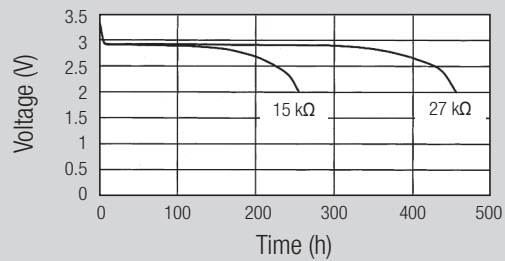

Discharge performance at 23°C



Discharge performance at 23°C

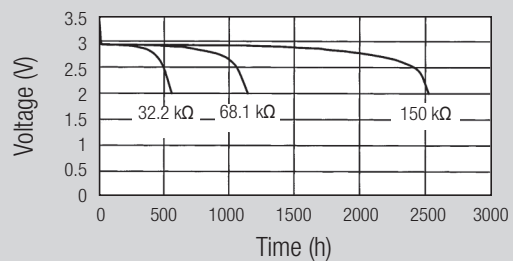

Temperature performance



Temperature performance

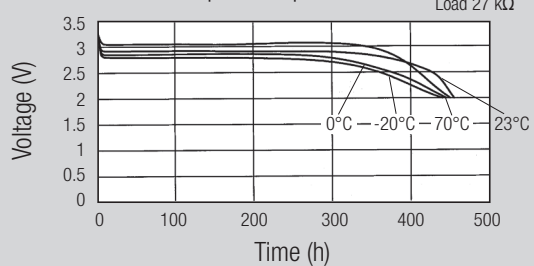

Cell capacity at various loads



Cell capacity at various loads

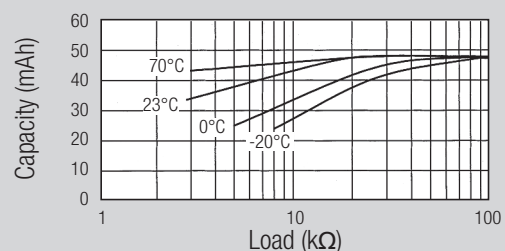

# Coin Cells

Standard bare coin cells

**CR1616**  Rated capacity: 50 mAh  
Average weight: 1.1 g

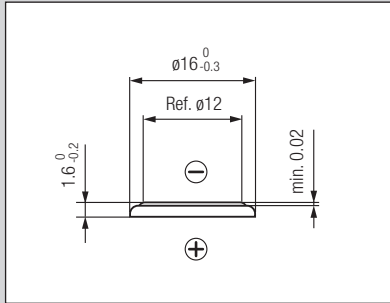

Discharge performance at 23°C

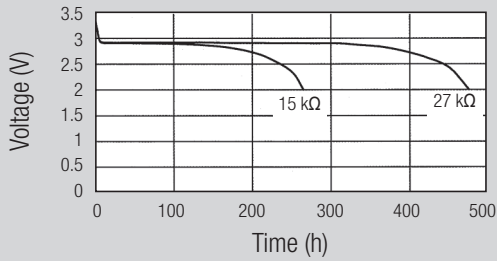

Discharge performance at 23°C

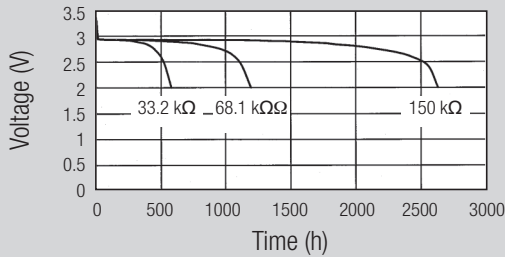

Temperature performance Load 27 kΩ

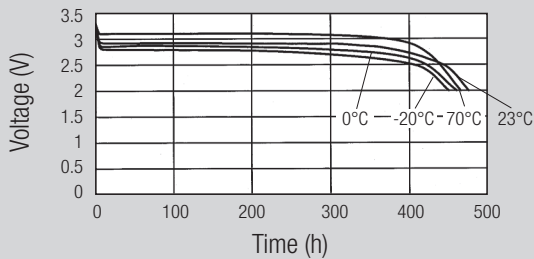

Cell capacity at various loads

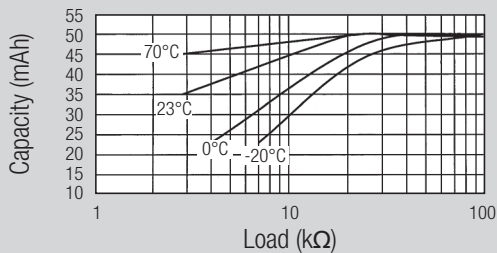

**CR1620**  Rated capacity: 68 mAh  
Average weight: 1.2 g

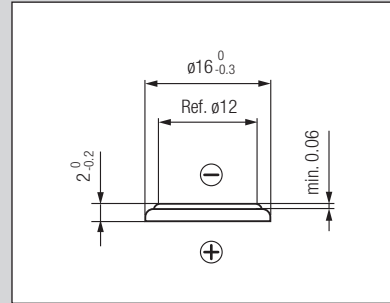

Discharge performance at 23°C

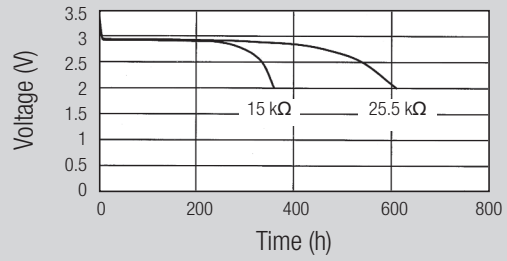

Discharge performance at 23°C

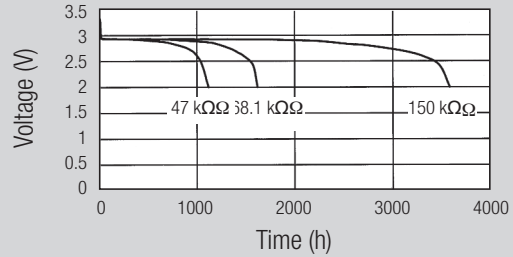

Temperature performance Load 25.5 kΩ

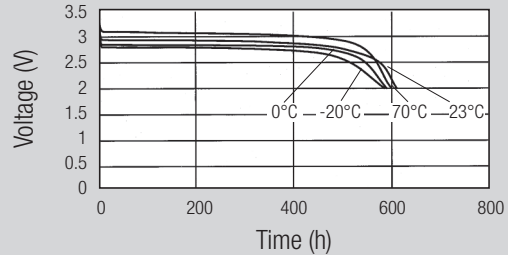

Cell capacity at various loads

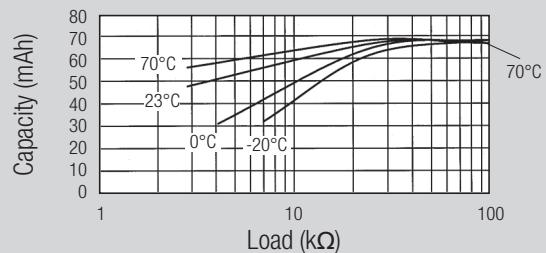



**CR1632**  Rated capacity: 125 mAh  
Average weight: 1.8 g

**CR2016 MFR**  Rated capacity: 90 mAh  
Average weight: 1.7 g



Discharge performance at 23°C



Discharge performance at 23°C

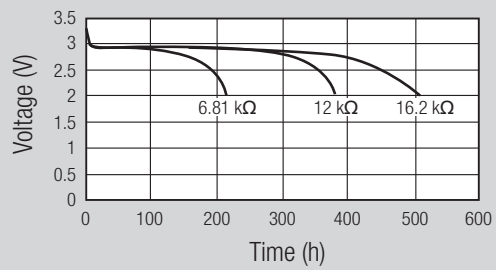

Discharge performance at 23°C



Discharge performance at 23°C

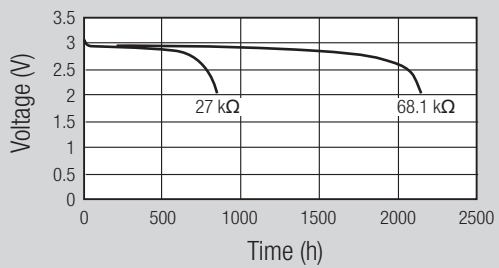

Temperature performance Load 16.2 kΩ



Temperature performance Load 27 kΩ

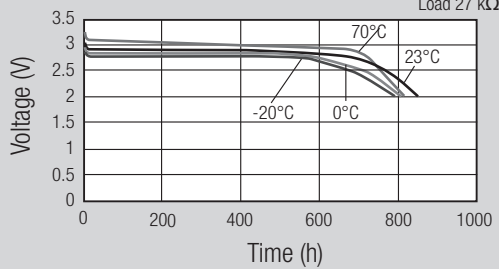

Cell capacity at various loads

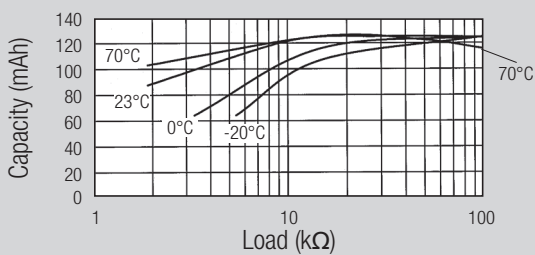

Cell capacity at various loads

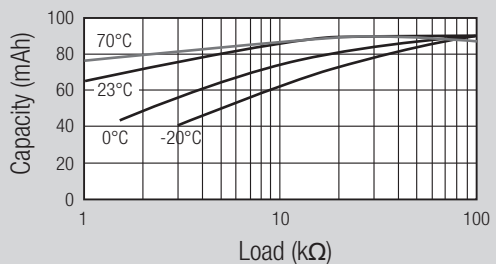

# Coin Cells

Standard bare coin cells



**CR2025 MFR**  Rated capacity: 165 mAh  
Average weight: 2.5 g

**CR2032 MFR**  Rated capacity: 225 mAh  
Average weight: 2.8 g



Discharge performance at 23°C



Discharge performance at 23°C



Discharge performance at 23°C



Discharge performance at 23°C



Temperature performance



Temperature performance



Cell capacity at various loads

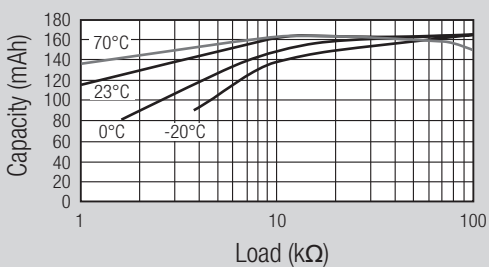

Cell capacity at various loads







**CR2320**  Rated capacity: 150 mAh  
Average weight: 2.7 g

**CR2325**  Rated capacity: 190 mAh  
Average weight: 3.0 g



Discharge performance at 23°C

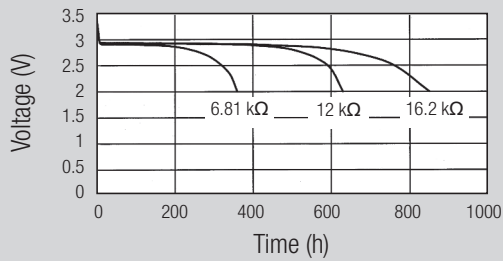

Discharge performance at 23°C



Discharge performance at 23°C

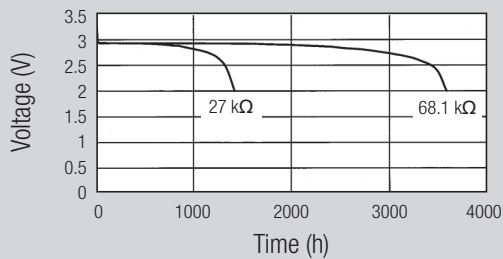

Discharge performance at 23°C

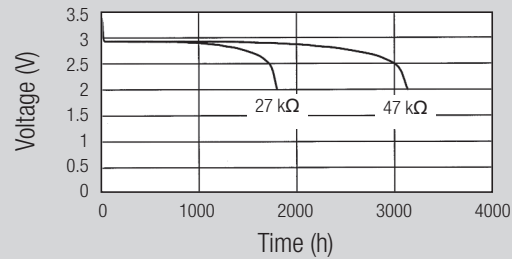

Temperature performance Load 16.2 kΩ

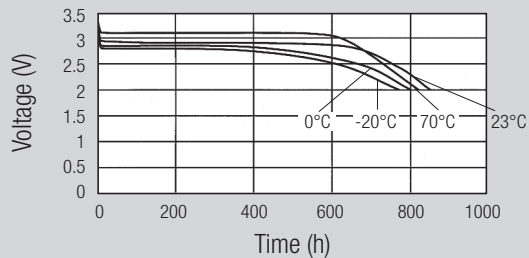

Temperature performance Load 12 kΩ

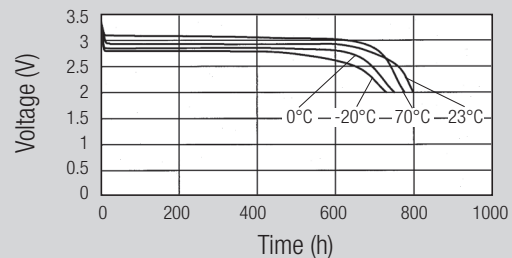

Cell capacity at various loads



Cell capacity at various loads



# Coin Cells

Standard bare coin cells



**CR2430**  Rated capacity: 285 mAh  
Average weight: 4.1 g



Discharge performance at 23°C

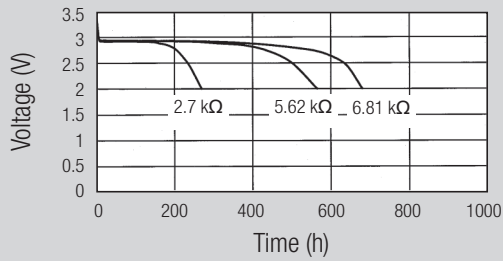

Discharge performance at 23°C

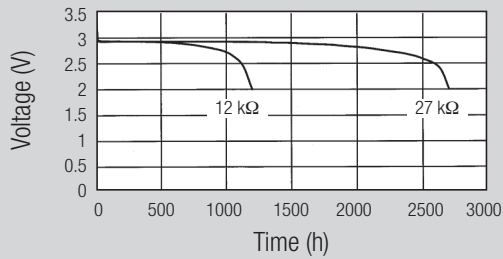

Temperature performance Load 12 kΩ



Cell capacity at various loads

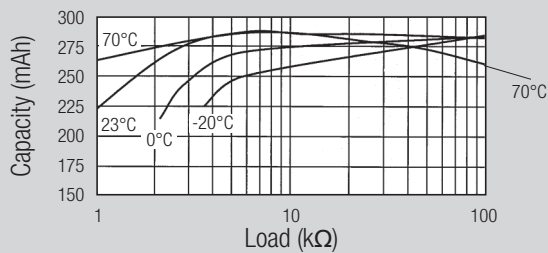

**CR2430 MFR**  Rated capacity: 300 mAh  
Average weight: 4.3 g

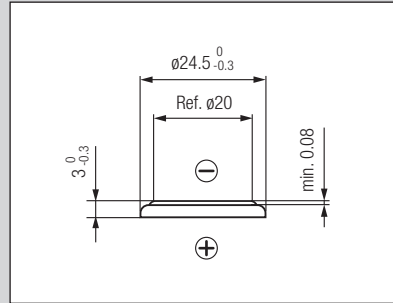

Discharge performance at 23°C

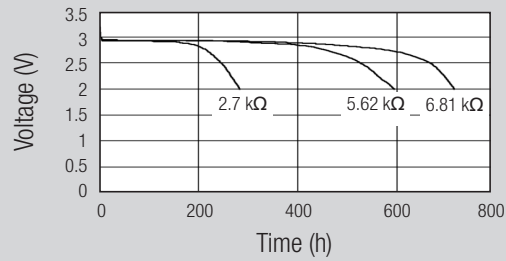

Discharge performance at 23°C

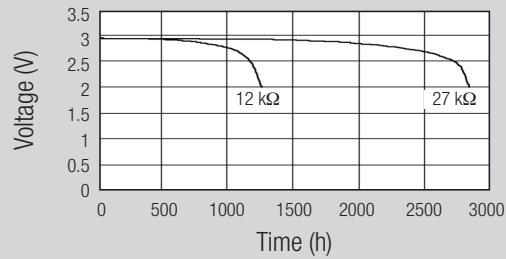

Temperature performance Load 12 kΩ



Cell capacity at various loads

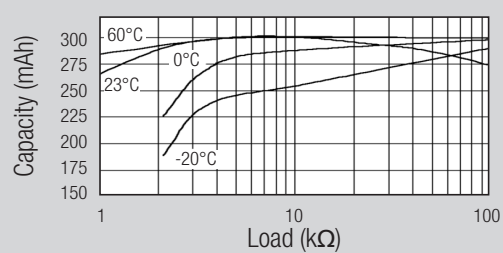



**CR2450N**  Rated capacity: 540 mAh  
Average weight: 5.9 g

**CR2477N** \* Rated capacity: 950 mAh  
Average weight: 8.2 g



Discharge performance at 23°C



Discharge performance at 23°C

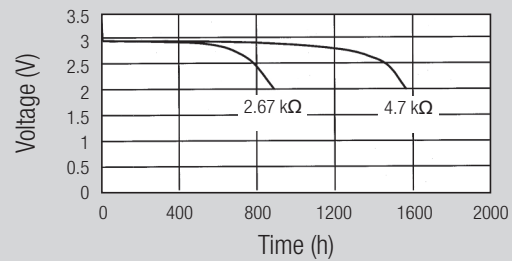

Discharge performance at 23°C



Discharge performance at 23°C

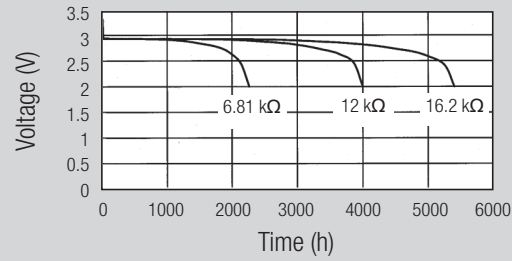

Temperature performance Load 6.81 kΩ



Temperature performance Load 4.7 kΩ

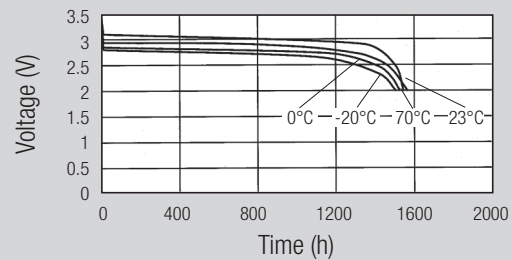

Cell capacity at various loads



Cell capacity at various loads



\* Battery is not user replaceable

# Coin Cells

## Packaging options

### Coin cells can be supplied in different packaging

#### Industrial Bulk multi-cell plastic trays

Packaging Code: IB<sup>1</sup>



Industrial Bulk packaging is the standard packaging for manufacturers.

The number of coin cells per plastic tray depends on the respective model. So does the number of plastic trays per shrink pack.

#### Singly packaged coin cells in blistered Card Units

Packaging Code: CU<sup>2</sup>

Card Unit packaging is e.g. used in replacement and retail business. There is one coin cell in a Card Unit, ten Card Units in a small box and ten small boxes in a bigger box.



#### Five coin cells packaged in blistered Tear Strips

Packaging Code: TS



Tear Strip packaging is e.g. used in retail or DIY stores. There are five coin cells in a Tear Strip, four Tear Strips in a small box and five small boxes in a bigger box.

#### Blistered multi-cell Bulk Tray

Packaging Code: BT



Bulk Tray packaging is e.g. used by small internet or catalogue distributors. The number of coin cells per Bulk Tray depends on the respective model. So does the number of plastic trays per cardboard box.

<sup>1</sup> Example: The Renata Part Name of CR2032 coin cells in industrial bulk packaging is "CR2032.IB".

<sup>2</sup> Example: The Renata Part Name of singly packaged CR1616 coin cells in card units is "CR1616.CU".

## Данный компонент на территории Российской Федерации

### Вы можете приобрести в компании MosChip.

Для оперативного оформления запроса Вам необходимо перейти по данной ссылке:

<http://moschip.ru/get-element>

Вы можете разместить у нас заказ для любого Вашего проекта, будь то серийное производство или разработка единичного прибора.

В нашем ассортименте представлены ведущие мировые производители активных и пассивных электронных компонентов.

Нашей специализацией является поставка электронной компонентной базы двойного назначения, продукции таких производителей как XILINX, Intel (ex.ALTERA), Vicor, Microchip, Texas Instruments, Analog Devices, Mini-Circuits, Amphenol, Glenair.

Сотрудничество с глобальными дистрибьюторами электронных компонентов, предоставляет возможность заказывать и получать с международных складов практически любой перечень компонентов в оптимальные для Вас сроки.

На всех этапах разработки и производства наши партнеры могут получить квалифицированную поддержку опытных инженеров.

Система менеджмента качества компании отвечает требованиям в соответствии с ГОСТ Р ИСО 9001, ГОСТ РВ 0015-002 и ЭС РД 009

### Офис по работе с юридическими лицами:

105318, г.Москва, ул.Щербаковская д.3, офис 1107, 1118, ДЦ «Щербаковский»

Телефон: +7 495 668-12-70 (многоканальный)

Факс: +7 495 668-12-70 (доб.304)

E-mail: [info@moschip.ru](mailto:info@moschip.ru)

Skype отдела продаж:

moschip.ru

moschip.ru\_4

moschip.ru\_6

moschip.ru\_9