

MLCC with Dipped Radial Lead

Halogen-free, Automotive Grade, High Temperature Application

FA Series (NP0, X8R)

Type:	Lead pitch	5.0 mm FA28 [4.0x5.5 mm] FA24 [4.5x5.5 mm] FA26 [5.5x6.0 mm] FA20 [5.5x7.0 mm] FA22 [7.5x8.5 mm]
	Lead pitch	2.5 mm FA18 [4.0x5.5 mm] FA14 [4.5x5.5 mm] FA16 [5.5x6.0 mm] FA11 [5.5x7.0 mm]



REMINDERS FOR USING THESE PRODUCTS

Before using these products, be sure to request the delivery specifications.

SAFETY REMINDERS

Please pay sufficient attention to the warnings for safe designing when using these products.

REMINDERS

- Do not use or store in locations where there are conditions such as gas corrosion (salt, acid, alkali, etc.).
- Before soldering, be sure to preheat components.
The preheating temperature should be set so that the temperature difference between the solder temperature and product temperature does not exceed 150°C.
- Soldering corrections after mounting should be within the range of the conditions determined in the specifications.
If overheated, a short circuit, performance deterioration, or lifespan shortening may occur.
- Self heating (temperature increase) occurs when the power is turned ON, so the tolerance should be sufficient for the set thermal design.
- Do not use for a purpose outside of the contents regulated in the delivery specifications.

- The products listed on this catalog are intended for use in automotive electronic equipment under a normal operation and use condition.

The products are not designed or warranted to meet the requirements of the applications listed below, whose performance and/or quality require a more stringent level of safety or reliability, or whose failure, malfunction or trouble could cause serious damage to society, person or property.

If you intend to use the products in the applications listed below or if you have special requirements exceeding the range or conditions set forth in the each catalog, please contact us.

- | | |
|---|--|
| (1) Aerospace/Aviation equipment | (8) Public information-processing equipment |
| (2) Transportation equipment (electric trains, ships, etc.) | (9) Military equipment |
| (3) Medical equipment | (10) Electric heating apparatus, burning equipment |
| (4) Power-generation control equipment | (11) Disaster prevention/crime prevention equipment |
| (5) Atomic energy-related equipment | (12) Safety equipment |
| (6) Seabed equipment | (13) Other applications that are not considered general-purpose applications |
| (7) Transportation control equipment | |

When designing your equipment even for automotive-purpose applications, you are kindly requested to take into consideration securing protection circuit/device or providing backup circuits in your equipment.

MLCC with Dipped Radial Lead

Product compatible with RoHS directive
Halogen-free

Halogen-free, Automotive Grade, High Temperature Application

Overview of the FA Series

FEATURES

- A lineup with a rated voltage of 25V to 100V.
- Compatible with a wide capacitance range of 10pF to 4.7μF.
- For guaranteed applications withstanding rigorous temperature environments of up to 150°C.
- The FA series for automotive use is AEC-Q200 compliant.

APPLICATION

- Noise reduction measures for various motors for automotive use
- Resonant circuits in areas such as keyless entry systems
- Bypass capacitors such as for switching power sources, smoothing capacitors, etc.
- Snubber circuits
- PFC input filters

PART NUMBER CONSTRUCTION

FA	2	8	NP0	1H	100	D	<input type="checkbox"/>	<input type="checkbox"/>	<input type="checkbox"/>	<input type="checkbox"/>
Series name	Lead pitch (mm)	LxWxT Dimensions (mm)	Capacitance temperature characteristics	Rated voltage (V)	Nominal capacitance	Capacitance tolerance*	Internal code	Packaging Style**		
	1 2.5	8 4.0x5.5x2.5	NP0 0±30ppm/°C	1E 25	100 10pF	D ±0.5pF		0 Bulk		
	2 5.0	4 4.5x5.5x3.0	X8R ±15%	1H 50	101 100pF	J ±5%		6 Taping		
		6 5.5x6.0x3.5		2A 100	102 1,000pF	K ±10%				
		0 5.5x7.0x4.0			105 1uF					
		1 5.5x7.0x4.0								
		2 7.5x8.5x4.5								

* Applicable capacitance range: Max. 10 pF for D, over 10 pF for J and K.

** Applied to the TDK's standard specification products.

OPERATING TEMPERATURE RANGE

Capacitance temperature characteristics	Operating temperature range	
	Operating temperature	Storage temperature*
	(°C)	(°C)
NP0, X8R	-55 to +150	-55 to +150

* The Storage temperature range is for after the circuit board is mounted.

- RoHS Directive Compliant Product: See the following for more details related to RoHS Directive compliant products. <http://product.tdk.com/en/environment/rohs/>
- Halogen-free: Indicates that Cl content is less than 900ppm, Br content is less than 900ppm, and that the total Cl and Br content is less than 1500ppm.

Please be sure to request delivery specifications that provide further details on the features and specifications of the products for proper and safe use. Please note that the contents may change without any prior notice due to reasons such as upgrading.

Overview of the FA Series

■ PACKAGE QUANTITY

Type	Package quantity	
	Taping (pieces / box)	Bulk (pieces / bag)
FA28	2000	500
FA24	2000	500
FA26	2000	500
FA20	1500	500
FA22	1000	500
FA18	2000	500
FA14	2000	500
FA16	2000	500
FA11	1500	500

Overview of the FA Series

RECOMMENDED FLOW PROFILE

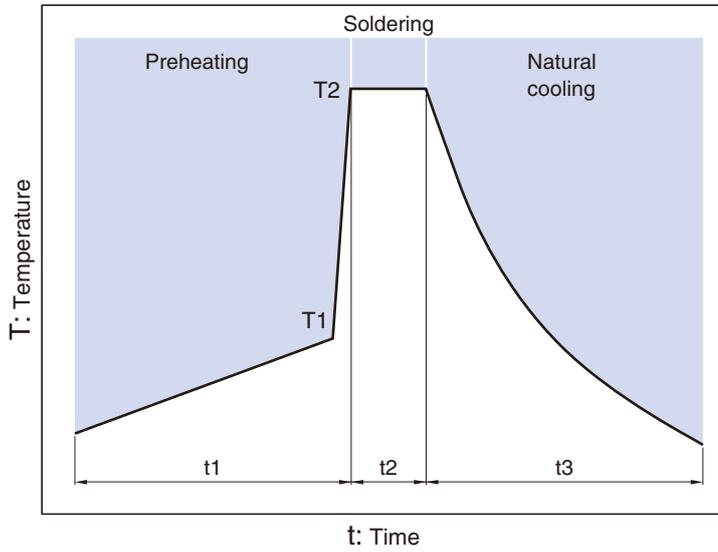

Preheating		Peak		Natural cooling
Temp.	Time	Temp.	Time	Time
T1	t1	T2	t2	t3
110°C min.	Over 60s.	260°C	Within 5s.	Over 60s.

FA28 Type

■ SHAPE & DIMENSIONS

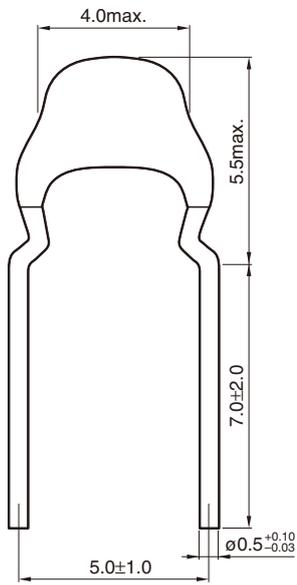

Dimensions in mm



Please be sure to request delivery specifications that provide further details on the features and specifications of the products for proper and safe use. Please note that the contents may change without any prior notice due to reasons such as upgrading.

FA28 Type

ELECTRICAL CHARACTERISTICS

CHARACTERISTICS SPECIFICATION TABLE

CLASS 1 (TEMPERATURE COMPENSATION)

Temperature characteristics	Capacitance	Tolerance	Rated voltage Edc (V)	Part No.*
NPO	10pF	±0.5pF	50	FA28NP01H100DNU0□**
NPO	15pF	±5%	50	FA28NP01H150JNU0□
NPO	22pF	±5%	50	FA28NP01H220JNU0□
NPO	33pF	±5%	50	FA28NP01H330JNU0□
NPO	47pF	±5%	50	FA28NP01H470JNU0□
NPO	68pF	±5%	50	FA28NP01H680JNU0□
NPO	100pF	±5%	50	FA28NP01H101JNU0□
NPO	120pF	±5%	50	FA28NP01H121JNU0□
NPO	150pF	±5%	50	FA28NP01H151JNU0□
NPO	180pF	±5%	50	FA28NP01H181JNU0□
NPO	220pF	±5%	50	FA28NP01H221JNU0□
NPO	270pF	±5%	50	FA28NP01H271JNU0□
NPO	330pF	±5%	50	FA28NP01H331JNU0□
NPO	390pF	±5%	50	FA28NP01H391JNU0□
NPO	470pF	±5%	50	FA28NP01H471JNU0□
NPO	560pF	±5%	50	FA28NP01H561JNU0□
NPO	680pF	±5%	50	FA28NP01H681JNU0□
NPO	820pF	±5%	50	FA28NP01H821JNU0□
NPO	1nF	±5%	50	FA28NP01H102JNU0□
NPO	1.2nF	±5%	50	FA28NP01H122JNU0□
NPO	1.5nF	±5%	50	FA28NP01H152JNU0□
NPO	1.8nF	±5%	50	FA28NP01H182JNU0□
NPO	2.2nF	±5%	50	FA28NP01H222JNU0□
NPO	2.7nF	±5%	50	FA28NP01H272JNU0□
NPO	3.3nF	±5%	50	FA28NP01H332JNU0□
NPO	3.9nF	±5%	50	FA28NP01H392JNU0□
NPO	4.7nF	±5%	50	FA28NP01H472JNU0□
NPO	5.6nF	±5%	50	FA28NP01H562JNU0□
NPO	6.8nF	±5%	50	FA28NP01H682JNU0□
NPO	8.2nF	±5%	50	FA28NP01H822JNU0□
NPO	10nF	±5%	50	FA28NP01H103JNU0□
NPO	10pF	±0.5pF	100	FA28NP02A100DNU0□
NPO	15pF	±5%	100	FA28NP02A150JNU0□
NPO	22pF	±5%	100	FA28NP02A220JNU0□
NPO	33pF	±5%	100	FA28NP02A330JNU0□
NPO	47pF	±5%	100	FA28NP02A470JNU0□
NPO	68pF	±5%	100	FA28NP02A680JNU0□
NPO	100pF	±5%	100	FA28NP02A101JNU0□
NPO	120pF	±5%	100	FA28NP02A121JNU0□
NPO	150pF	±5%	100	FA28NP02A151JNU0□
NPO	180pF	±5%	100	FA28NP02A181JNU0□
NPO	220pF	±5%	100	FA28NP02A221JNU0□
NPO	270pF	±5%	100	FA28NP02A271JNU0□
NPO	330pF	±5%	100	FA28NP02A331JNU0□
NPO	390pF	±5%	100	FA28NP02A391JNU0□
NPO	470pF	±5%	100	FA28NP02A471JNU0□
NPO	560pF	±5%	100	FA28NP02A561JNU0□
NPO	680pF	±5%	100	FA28NP02A681JNU0□
NPO	820pF	±5%	100	FA28NP02A821JNU0□
NPO	1nF	±5%	100	FA28NP02A102JNU0□
NPO	1.2nF	±5%	100	FA28NP02A122JNU0□
NPO	1.5nF	±5%	100	FA28NP02A152JNU0□
NPO	1.8nF	±5%	100	FA28NP02A182JNU0□
NPO	2.2nF	±5%	100	FA28NP02A222JNU0□
NPO	2.7nF	±5%	100	FA28NP02A272JNU0□
NPO	3.3nF	±5%	100	FA28NP02A332JNU0□

* The part numbers are TDK's standard specification products.

** The "□" of the Part Number contains the packaging symbol, 0 (Bulk packaging) or 6 (Taping packaging).

⚠ Please be sure to request delivery specifications that provide further details on the features and specifications of the products for proper and safe use. Please note that the contents may change without any prior notice due to reasons such as upgrading.

FA28 Type

ELECTRICAL CHARACTERISTICS

CHARACTERISTICS SPECIFICATION TABLE

CLASS 2 (TEMPERATURE STABLE)

Temperature characteristics	Capacitance	Tolerance	Rated voltage Edc (V)	Part No.*
X8R	68nF	±10%	25	FA28X8R1E683KNU0□**
X8R	100nF	±10%	25	FA28X8R1E104KNU0□
X8R	150nF	±10%	25	FA28X8R1E154KRU0□
X8R	220nF	±10%	25	FA28X8R1E224KRU0□
X8R	1nF	±10%	50	FA28X8R1H102KNU0□
X8R	1.5nF	±10%	50	FA28X8R1H152KNU0□
X8R	2.2nF	±10%	50	FA28X8R1H222KNU0□
X8R	3.3nF	±10%	50	FA28X8R1H332KNU0□
X8R	4.7nF	±10%	50	FA28X8R1H472KNU0□
X8R	6.8nF	±10%	50	FA28X8R1H682KNU0□
X8R	10nF	±10%	50	FA28X8R1H103KNU0□
X8R	15nF	±10%	50	FA28X8R1H153KNU0□
X8R	22nF	±10%	50	FA28X8R1H223KNU0□
X8R	33nF	±10%	50	FA28X8R1H333KNU0□
X8R	47nF	±10%	50	FA28X8R1H473KNU0□
X8R	68nF	±10%	50	FA28X8R1H683KRU0□
X8R	100nF	±10%	50	FA28X8R1H104KRU0□
X8R	1nF	±10%	100	FA28X8R2A102KNU0□
X8R	1.5nF	±10%	100	FA28X8R2A152KNU0□
X8R	2.2nF	±10%	100	FA28X8R2A222KNU0□
X8R	3.3nF	±10%	100	FA28X8R2A332KNU0□
X8R	4.7nF	±10%	100	FA28X8R2A472KNU0□
X8R	6.8nF	±10%	100	FA28X8R2A682KNU0□
X8R	10nF	±10%	100	FA28X8R2A103KNU0□
X8R	15nF	±10%	100	FA28X8R2A153KNU0□
X8R	22nF	±10%	100	FA28X8R2A223KRU0□
X8R	33nF	±10%	100	FA28X8R2A333KRU0□

* The part numbers are TDK's standard specification products.

** The "□" of the Part Number contains the packaging symbol, 0 (Bulk packaging) or 6 (Taping packaging).

FA24 Type

■ SHAPE & DIMENSIONS

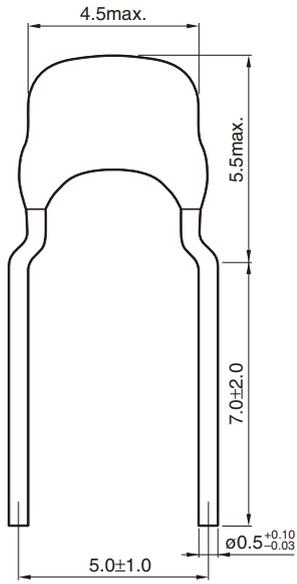

Dimensions in mm



Please be sure to request delivery specifications that provide further details on the features and specifications of the products for proper and safe use. Please note that the contents may change without any prior notice due to reasons such as upgrading.

FA24 Type

ELECTRICAL CHARACTERISTICS

CHARACTERISTICS SPECIFICATION TABLE

CLASS 1 (TEMPERATURE COMPENSATION)

Temperature characteristics	Capacitance	Tolerance	Rated voltage Edc (V)	Part No.*
NPO	15nF	±5%	50	FA24NP01H153JNU0□**
NPO	22nF	±5%	50	FA24NP01H223JNU0□
NPO	33nF	±5%	50	FA24NP01H333JNU0□
NPO	3.9nF	±5%	100	FA24NP02A392JNU0□
NPO	4.7nF	±5%	100	FA24NP02A472JNU0□
NPO	5.6nF	±5%	100	FA24NP02A562JNU0□
NPO	6.8nF	±5%	100	FA24NP02A682JNU0□
NPO	8.2nF	±5%	100	FA24NP02A822JNU0□
NPO	10nF	±5%	100	FA24NP02A103JNU0□

* The part numbers are TDK's standard specification products.

** The "□" of the Part Number contains the packaging symbol, 0 (Bulk packaging) or 6 (Taping packaging).

CLASS 2 (TEMPERATURE STABLE)

Temperature characteristics	Capacitance	Tolerance	Rated voltage Edc (V)	Part No.*
X8R	150nF	±10%	25	FA24X8R1E154KNU0□**
X8R	220nF	±10%	25	FA24X8R1E224KNU0□
X8R	330nF	±10%	25	FA24X8R1E334KNU0□
X8R	470nF	±10%	25	FA24X8R1E474KRU0□
X8R	68nF	±10%	50	FA24X8R1H683KNU0□
X8R	100nF	±10%	50	FA24X8R1H104KNU0□
X8R	150nF	±10%	50	FA24X8R1H154KRU0□
X8R	220nF	±10%	50	FA24X8R1H224KRU0□
X8R	22nF	±10%	100	FA24X8R2A223KNU0□
X8R	47nF	±10%	100	FA24X8R2A473KRU0□
X8R	68nF	±10%	100	FA24X8R2A683KRU0□

* The part numbers are TDK's standard specification products.

** The "□" of the Part Number contains the packaging symbol, 0 (Bulk packaging) or 6 (Taping packaging).

FA26 Type

■ SHAPE & DIMENSIONS

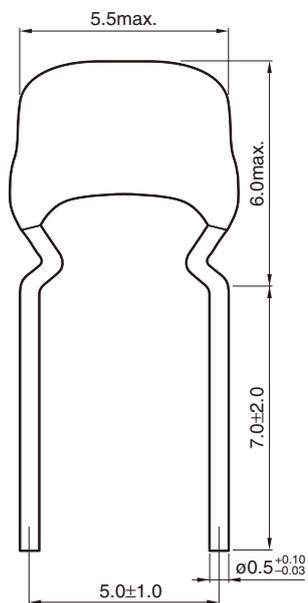

Dimensions in mm



Please be sure to request delivery specifications that provide further details on the features and specifications of the products for proper and safe use. Please note that the contents may change without any prior notice due to reasons such as upgrading.

FA26 Type

ELECTRICAL CHARACTERISTICS

CHARACTERISTICS SPECIFICATION TABLE

CLASS 1 (TEMPERATURE COMPENSATION)

Temperature characteristics	Capacitance	Tolerance	Rated voltage Edc (V)	Part No.*
NPO	47nF	±5%	50	FA26NP01H473JNU0□**
NPO	68nF	±5%	50	FA26NP01H683JNU0□
NPO	100nF	±5%	50	FA26NP01H104JNU0□
NPO	15nF	±5%	100	FA26NP02A153JNU0□
NPO	22nF	±5%	100	FA26NP02A223JNU0□
NPO	33nF	±5%	100	FA26NP02A333JNU0□

* The part numbers are TDK's standard specification products.

** The "□" of the Part Number contains the packaging symbol, 0 (Bulk packaging) or 6 (Taping packaging).

CLASS 2 (TEMPERATURE STABLE)

Temperature characteristics	Capacitance	Tolerance	Rated voltage Edc (V)	Part No.*
X8R	470nF	±10%	25	FA26X8R1E474KNU0□**
X8R	680nF	±10%	25	FA26X8R1E684KNU0□
X8R	1uF	±10%	25	FA26X8R1E105KNU0□
X8R	1.5uF	±10%	25	FA26X8R1E155KRU0□
X8R	2.2uF	±10%	25	FA26X8R1E225KRU0□
X8R	150nF	±10%	50	FA26X8R1H154KNU0□
X8R	220nF	±10%	50	FA26X8R1H224KNU0□
X8R	330nF	±10%	50	FA26X8R1H334KNU0□
X8R	470nF	±10%	50	FA26X8R1H474KNU0□
X8R	680nF	±10%	50	FA26X8R1H684KRU0□
X8R	1uF	±10%	50	FA26X8R1H105KRU0□
X8R	33nF	±10%	100	FA26X8R2A333KNU0□
X8R	47nF	±10%	100	FA26X8R2A473KNU0□
X8R	68nF	±10%	100	FA26X8R2A683KNU0□
X8R	100nF	±10%	100	FA26X8R2A104KNU0□
X8R	150nF	±10%	100	FA26X8R2A154KNU0□
X8R	220nF	±10%	100	FA26X8R2A224KRU0□
X8R	330nF	±10%	100	FA26X8R2A334KRU0□

* The part numbers are TDK's standard specification products.

** The "□" of the Part Number contains the packaging symbol, 0 (Bulk packaging) or 6 (Taping packaging).

FA20 Type

■ SHAPE & DIMENSIONS

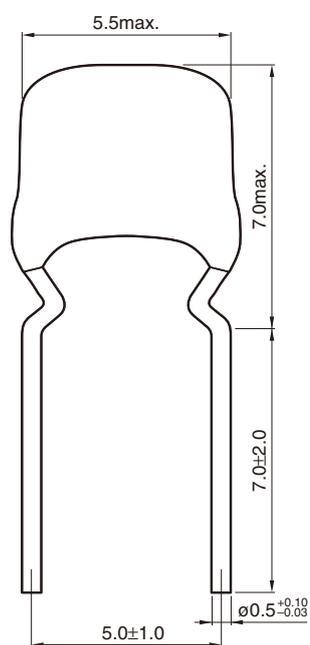

Dimensions in mm



FA20 Type

ELECTRICAL CHARACTERISTICS

CHARACTERISTICS SPECIFICATION TABLE

CLASS 1 (TEMPERATURE COMPENSATION)

Temperature characteristics	Capacitance	Tolerance	Rated voltage Edc (V)	Part No.*
NPO	47nF	±5%	100	FA20NP02A473JNU0□**
NPO	68nF	±5%	100	FA20NP02A683JNU0□

* The part numbers are TDK's standard specification products.

** The "□" of the Part Number contains the packaging symbol, 0 (Bulk packaging) or 6 (Taping packaging).

CLASS 2 (TEMPERATURE STABLE)

Temperature characteristics	Capacitance	Tolerance	Rated voltage Edc (V)	Part No.*
X8R	1.5uF	±10%	25	FA20X8R1E155KNU0□**
X8R	2.2uF	±10%	25	FA20X8R1E225KNU0□
X8R	3.3uF	±10%	25	FA20X8R1E335KNU0□
X8R	4.7uF	±10%	25	FA20X8R1E475KRU0□
X8R	470nF	±10%	100	FA20X8R2A474KRU0□
X8R	680nF	±10%	100	FA20X8R2A684KRU0□

* The part numbers are TDK's standard specification products.

** The "□" of the Part Number contains the packaging symbol, 0 (Bulk packaging) or 6 (Taping packaging).

FA22 Type

■ SHAPE & DIMENSIONS

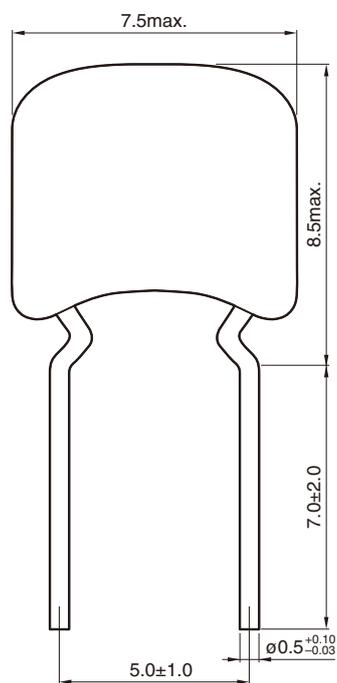

Dimensions in mm



Please be sure to request delivery specifications that provide further details on the features and specifications of the products for proper and safe use. Please note that the contents may change without any prior notice due to reasons such as upgrading.

FA22 Type

■ ELECTRICAL CHARACTERISTICS

□ CHARACTERISTICS SPECIFICATION TABLE

CLASS 1 (TEMPERATURE COMPENSATION)

Temperature characteristics	Capacitance	Tolerance	Rated voltage Edc (V)	Part No.*
NPO	150nF	±5%	50	FA22NP01H154JNU0□**
NPO	220nF	±5%	50	FA22NP01H224JNU0□
NPO	100nF	±5%	100	FA22NP02A104JNU0□

* The part numbers are TDK's standard specification products.

** The "□" of the Part Number contains the packaging symbol, 0 (Bulk packaging) or 6 (Taping packaging).

FA18 Type

■ SHAPE & DIMENSIONS

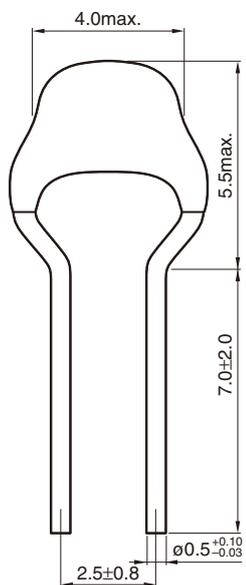

Dimensions in mm



FA18 Type

ELECTRICAL CHARACTERISTICS

CHARACTERISTICS SPECIFICATION TABLE

CLASS 1 (TEMPERATURE COMPENSATION)

Temperature characteristics	Capacitance	Tolerance	Rated voltage Edc (V)	Part No.*
NPO	10pF	±0.5pF	50	FA18NP01H100DNU0□**
NPO	15pF	±5%	50	FA18NP01H150JNU0□
NPO	22pF	±5%	50	FA18NP01H220JNU0□
NPO	33pF	±5%	50	FA18NP01H330JNU0□
NPO	47pF	±5%	50	FA18NP01H470JNU0□
NPO	68pF	±5%	50	FA18NP01H680JNU0□
NPO	100pF	±5%	50	FA18NP01H101JNU0□
NPO	120pF	±5%	50	FA18NP01H121JNU0□
NPO	150pF	±5%	50	FA18NP01H151JNU0□
NPO	180pF	±5%	50	FA18NP01H181JNU0□
NPO	220pF	±5%	50	FA18NP01H221JNU0□
NPO	270pF	±5%	50	FA18NP01H271JNU0□
NPO	330pF	±5%	50	FA18NP01H331JNU0□
NPO	390pF	±5%	50	FA18NP01H391JNU0□
NPO	470pF	±5%	50	FA18NP01H471JNU0□
NPO	560pF	±5%	50	FA18NP01H561JNU0□
NPO	680pF	±5%	50	FA18NP01H681JNU0□
NPO	820pF	±5%	50	FA18NP01H821JNU0□
NPO	1nF	±5%	50	FA18NP01H102JNU0□
NPO	1.2nF	±5%	50	FA18NP01H122JNU0□
NPO	1.5nF	±5%	50	FA18NP01H152JNU0□
NPO	1.8nF	±5%	50	FA18NP01H182JNU0□
NPO	2.2nF	±5%	50	FA18NP01H222JNU0□
NPO	2.7nF	±5%	50	FA18NP01H272JNU0□
NPO	3.3nF	±5%	50	FA18NP01H332JNU0□
NPO	3.9nF	±5%	50	FA18NP01H392JNU0□
NPO	4.7nF	±5%	50	FA18NP01H472JNU0□
NPO	5.6nF	±5%	50	FA18NP01H562JNU0□
NPO	6.8nF	±5%	50	FA18NP01H682JNU0□
NPO	8.2nF	±5%	50	FA18NP01H822JNU0□
NPO	10nF	±5%	50	FA18NP01H103JNU0□
NPO	10pF	±0.5pF	100	FA18NP02A100DNU0□
NPO	15pF	±5%	100	FA18NP02A150JNU0□
NPO	22pF	±5%	100	FA18NP02A220JNU0□
NPO	33pF	±5%	100	FA18NP02A330JNU0□
NPO	47pF	±5%	100	FA18NP02A470JNU0□
NPO	68pF	±5%	100	FA18NP02A680JNU0□
NPO	100pF	±5%	100	FA18NP02A101JNU0□
NPO	120pF	±5%	100	FA18NP02A121JNU0□
NPO	150pF	±5%	100	FA18NP02A151JNU0□
NPO	180pF	±5%	100	FA18NP02A181JNU0□
NPO	220pF	±5%	100	FA18NP02A221JNU0□
NPO	270pF	±5%	100	FA18NP02A271JNU0□
NPO	330pF	±5%	100	FA18NP02A331JNU0□
NPO	390pF	±5%	100	FA18NP02A391JNU0□
NPO	470pF	±5%	100	FA18NP02A471JNU0□
NPO	560pF	±5%	100	FA18NP02A561JNU0□
NPO	680pF	±5%	100	FA18NP02A681JNU0□
NPO	820pF	±5%	100	FA18NP02A821JNU0□
NPO	1nF	±5%	100	FA18NP02A102JNU0□
NPO	1.2nF	±5%	100	FA18NP02A122JNU0□
NPO	1.5nF	±5%	100	FA18NP02A152JNU0□
NPO	1.8nF	±5%	100	FA18NP02A182JNU0□
NPO	2.2nF	±5%	100	FA18NP02A222JNU0□
NPO	2.7nF	±5%	100	FA18NP02A272JNU0□
NPO	3.3nF	±5%	100	FA18NP02A332JNU0□

* The part numbers are TDK's standard specification products.

** The "□" of the Part Number contains the packaging symbol, 0 (Bulk packaging) or 6 (Taping packaging).

 Please be sure to request delivery specifications that provide further details on the features and specifications of the products for proper and safe use. Please note that the contents may change without any prior notice due to reasons such as upgrading.

FA18 Type

ELECTRICAL CHARACTERISTICS

CHARACTERISTICS SPECIFICATION TABLE

CLASS 2 (TEMPERATURE STABLE)

Temperature characteristics	Capacitance	Tolerance	Rated voltage Edc (V)	Part No.*
X8R	68nF	±10%	25	FA18X8R1E683KNU0□**
X8R	100nF	±10%	25	FA18X8R1E104KNU0□
X8R	150nF	±10%	25	FA18X8R1E154KRU0□
X8R	220nF	±10%	25	FA18X8R1E224KRU0□
X8R	1nF	±10%	50	FA18X8R1H102KNU0□
X8R	1.5nF	±10%	50	FA18X8R1H152KNU0□
X8R	2.2nF	±10%	50	FA18X8R1H222KNU0□
X8R	3.3nF	±10%	50	FA18X8R1H332KNU0□
X8R	4.7nF	±10%	50	FA18X8R1H472KNU0□
X8R	6.8nF	±10%	50	FA18X8R1H682KNU0□
X8R	10nF	±10%	50	FA18X8R1H103KNU0□
X8R	15nF	±10%	50	FA18X8R1H153KNU0□
X8R	22nF	±10%	50	FA18X8R1H223KNU0□
X8R	33nF	±10%	50	FA18X8R1H333KNU0□
X8R	47nF	±10%	50	FA18X8R1H473KNU0□
X8R	68nF	±10%	50	FA18X8R1H683KRU0□
X8R	100nF	±10%	50	FA18X8R1H104KRU0□
X8R	1nF	±10%	100	FA18X8R2A102KNU0□
X8R	1.5nF	±10%	100	FA18X8R2A152KNU0□
X8R	2.2nF	±10%	100	FA18X8R2A222KNU0□
X8R	3.3nF	±10%	100	FA18X8R2A332KNU0□
X8R	4.7nF	±10%	100	FA18X8R2A472KNU0□
X8R	6.8nF	±10%	100	FA18X8R2A682KNU0□
X8R	10nF	±10%	100	FA18X8R2A103KNU0□
X8R	15nF	±10%	100	FA18X8R2A153KNU0□
X8R	22nF	±10%	100	FA18X8R2A223KRU0□
X8R	33nF	±10%	100	FA18X8R2A333KRU0□

* The part numbers are TDK's standard specification products.

** The "□" of the Part Number contains the packaging symbol, 0 (Bulk packaging) or 6 (Taping packaging).

FA14 Type

■ SHAPE & DIMENSIONS

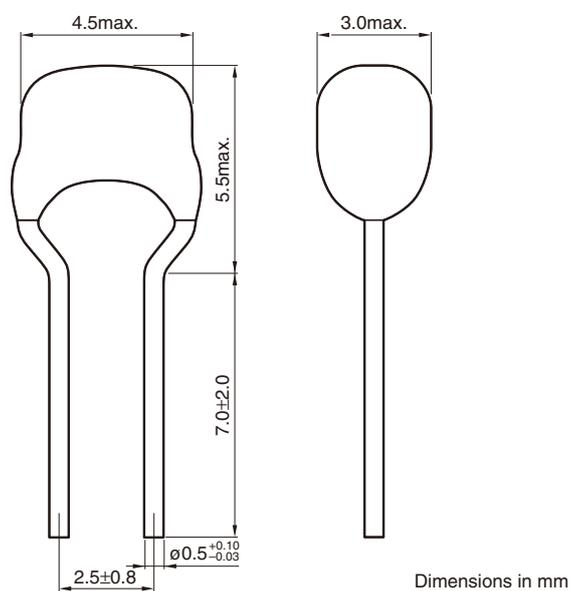

FA14 Type

■ ELECTRICAL CHARACTERISTICS

□ CHARACTERISTICS SPECIFICATION TABLE

CLASS 1 (TEMPERATURE COMPENSATION)

Temperature characteristics	Capacitance	Tolerance	Rated voltage Edc (V)	Part No.*
NPO	15nF	±5%	50	FA14NP01H153JNU0□**
NPO	22nF	±5%	50	FA14NP01H223JNU0□
NPO	33nF	±5%	50	FA14NP01H333JNU0□
NPO	3.9nF	±5%	100	FA14NP02A392JNU0□
NPO	4.7nF	±5%	100	FA14NP02A472JNU0□
NPO	5.6nF	±5%	100	FA14NP02A562JNU0□
NPO	6.8nF	±5%	100	FA14NP02A682JNU0□
NPO	8.2nF	±5%	100	FA14NP02A822JNU0□
NPO	10nF	±5%	100	FA14NP02A103JNU0□

* The part numbers are TDK's standard specification products.

** The "□" of the Part Number contains the packaging symbol, 0 (Bulk packaging) or 6 (Taping packaging).

CLASS 2 (TEMPERATURE STABLE)

Temperature characteristics	Capacitance	Tolerance	Rated voltage Edc (V)	Part No.*
X8R	150nF	±10%	25	FA14X8R1E154KNU0□**
X8R	220nF	±10%	25	FA14X8R1E224KNU0□
X8R	330nF	±10%	25	FA14X8R1E334KNU0□
X8R	470nF	±10%	25	FA14X8R1E474KRU0□
X8R	68nF	±10%	50	FA14X8R1H683KNU0□
X8R	100nF	±10%	50	FA14X8R1H104KNU0□
X8R	150nF	±10%	50	FA14X8R1H154KRU0□
X8R	220nF	±10%	50	FA14X8R1H224KRU0□
X8R	22nF	±10%	100	FA14X8R2A223KNU0□
X8R	47nF	±10%	100	FA14X8R2A473KRU0□
X8R	68nF	±10%	100	FA14X8R2A683KRU0□

* The part numbers are TDK's standard specification products.

** The "□" of the Part Number contains the packaging symbol, 0 (Bulk packaging) or 6 (Taping packaging).

FA16 Type

■ SHAPE & DIMENSIONS

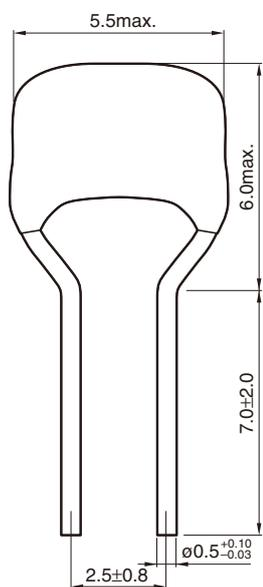

Dimensions in mm



FA16 Type

ELECTRICAL CHARACTERISTICS

CHARACTERISTICS SPECIFICATION TABLE

CLASS 1 (TEMPERATURE COMPENSATION)

Temperature characteristics	Capacitance	Tolerance	Rated voltage Edc (V)	Part No.*
NPO	47nF	±5%	50	FA16NP01H473JNU0□**
NPO	68nF	±5%	50	FA16NP01H683JNU0□
NPO	100nF	±5%	50	FA16NP01H104JNU0□
NPO	15nF	±5%	100	FA16NP02A153JNU0□
NPO	22nF	±5%	100	FA16NP02A223JNU0□
NPO	33nF	±5%	100	FA16NP02A333JNU0□

* The part numbers are TDK's standard specification products.

** The "□" of the Part Number contains the packaging symbol, 0 (Bulk packaging) or 6 (Taping packaging).

CLASS 2 (TEMPERATURE STABLE)

Temperature characteristics	Capacitance	Tolerance	Rated voltage Edc (V)	Part No.*
X8R	470nF	±10%	25	FA16X8R1E474KNU0□**
X8R	680nF	±10%	25	FA16X8R1E684KNU0□
X8R	1uF	±10%	25	FA16X8R1E105KNU0□
X8R	1.5uF	±10%	25	FA16X8R1E155KRU0□
X8R	2.2uF	±10%	25	FA16X8R1E225KRU0□
X8R	150nF	±10%	50	FA16X8R1H154KNU0□
X8R	220nF	±10%	50	FA16X8R1H224KNU0□
X8R	330nF	±10%	50	FA16X8R1H334KNU0□
X8R	470nF	±10%	50	FA16X8R1H474KNU0□
X8R	680nF	±10%	50	FA16X8R1H684KRU0□
X8R	1uF	±10%	50	FA16X8R1H105KRU0□
X8R	33nF	±10%	100	FA16X8R2A333KNU0□
X8R	47nF	±10%	100	FA16X8R2A473KNU0□
X8R	68nF	±10%	100	FA16X8R2A683KNU0□
X8R	100nF	±10%	100	FA16X8R2A104KNU0□
X8R	150nF	±10%	100	FA16X8R2A154KNU0□
X8R	220nF	±10%	100	FA16X8R2A224KRU0□
X8R	330nF	±10%	100	FA16X8R2A334KRU0□

* The part numbers are TDK's standard specification products.

** The "□" of the Part Number contains the packaging symbol, 0 (Bulk packaging) or 6 (Taping packaging).

FA11 Type

■ SHAPE & DIMENSIONS

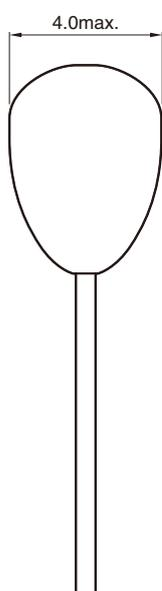
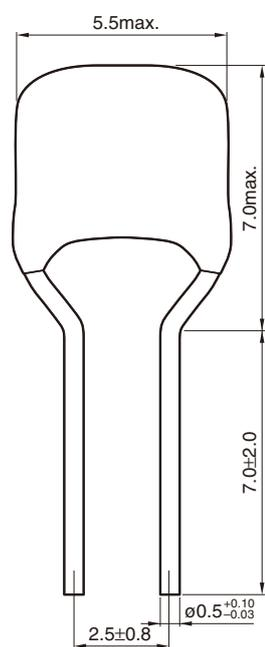

Dimensions in mm



FA11 Type

■ ELECTRICAL CHARACTERISTICS

□ CHARACTERISTICS SPECIFICATION TABLE

CLASS 1 (TEMPERATURE COMPENSATION)

Temperature characteristics	Capacitance	Tolerance	Rated voltage Edc (V)	Part No.*
NPO	47nF	±5%	100	FA11NP02A473JNU0□**
NPO	68nF	±5%	100	FA11NP02A683JNU0□

* The part numbers are TDK's standard specification products.

** The "□" of the Part Number contains the packaging symbol, 0 (Bulk packaging) or 6 (Taping packaging).

CLASS 2 (TEMPERATURE STABLE)

Temperature characteristics	Capacitance	Tolerance	Rated voltage Edc (V)	Part No.*
X8R	1.5uF	±10%	25	FA11X8R1E155KNU0□**
X8R	2.2uF	±10%	25	FA11X8R1E225KNU0□
X8R	3.3uF	±10%	25	FA11X8R1E335KNU0□
X8R	4.7uF	±10%	25	FA11X8R1E475KRU0□
X8R	470nF	±10%	100	FA11X8R2A474KRU0□
X8R	680nF	±10%	100	FA11X8R2A684KRU0□

* The part numbers are TDK's standard specification products.

** The "□" of the Part Number contains the packaging symbol, 0 (Bulk packaging) or 6 (Taping packaging).

Packaging Style

■ TAPING DIMENSIONS

□ Lead pitch 5.0 mm

(FA28, FA24, FA26, FA20, FA22 Type)

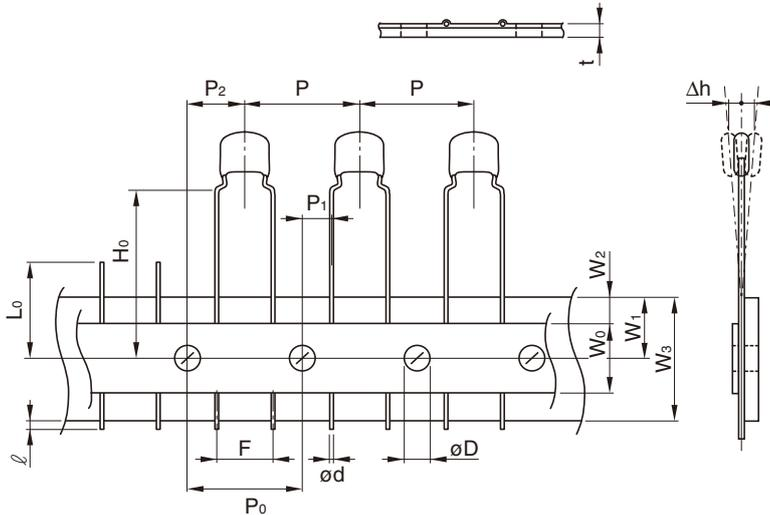

Symbol	Dimensions (mm)
P	12.7±1.0
P ₀ * ¹	12.7±0.3
P ₁	3.85±0.7
P ₂	6.35±1.3
W ₀	12.0±1.0
W ₁	9.0±0.5
W ₂ * ²	3.0max.
W ₃	18.0+1.0, -0.5
H ₀	16.0±0.5
ℓ	1.0max.
t	0.6±0.2
L ₀ * ³	11.0max.
F	5.0+0.8
ød	ø0.5+0.1, -0.03
øD	ø4.0±0.2
Δh	0±2

*¹ Accumulated pitch tolerance shall be ±2mm for 20 pitches.

*² Adhesive tape shall not stick out from carrier tape.

*³ The number of consecutive gaps in the product shall be three or less.

□ Lead pitch 2.5 mm

(FA18, FA14, FA16, FA11 Type)

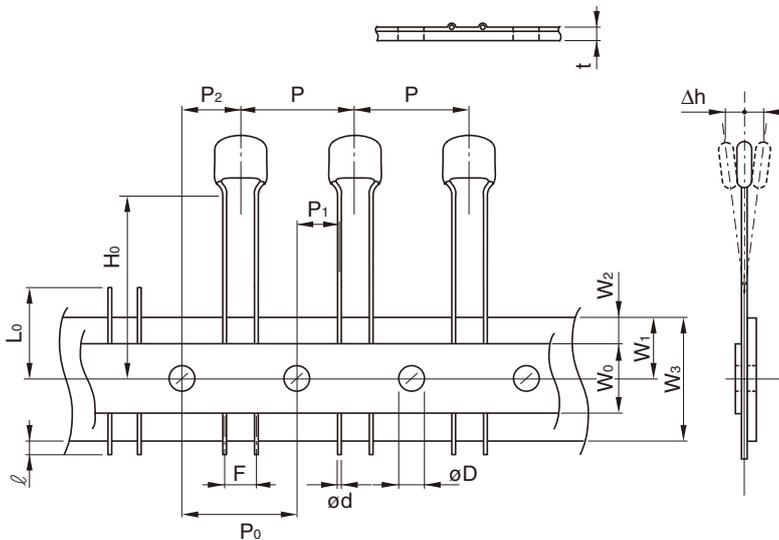

Symbol	Dimensions (mm)
P	12.7±1.0
P ₀ * ¹	12.7±0.3
P ₁	5.1±0.7
P ₂	6.35±1.3
W ₀	12.0±1.0
W ₁	9.0±0.5
W ₂ * ²	3.0max.
W ₃	18.0+1.0, -0.5
H ₀	16.0±0.5
ℓ	1.0max.
t	0.6±0.2
L ₀ * ³	11.0max.
F	2.5+0.5
ød	ø0.5+0.1, -0.03
øD	ø4.0±0.2
Δh	0±2

*¹ Accumulated pitch tolerance shall be ±2mm for 20 pitches.

*² Adhesive tape shall not stick out from carrier tape.

*³ The number of consecutive gaps in the product shall be three or less.

■ AMMO PACK INNER BOX SIZE

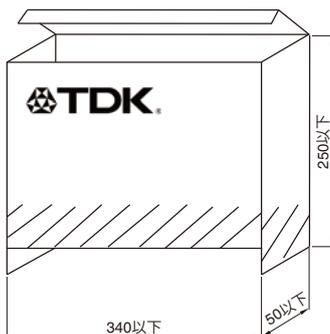

Dimensions in mm

⚠ Please be sure to request delivery specifications that provide further details on the features and specifications of the products for proper and safe use. Please note that the contents may change without any prior notice due to reasons such as upgrading.

Данный компонент на территории Российской Федерации

Вы можете приобрести в компании MosChip.

Для оперативного оформления запроса Вам необходимо перейти по данной ссылке:

<http://moschip.ru/get-element>

Вы можете разместить у нас заказ для любого Вашего проекта, будь то серийное производство или разработка единичного прибора.

В нашем ассортименте представлены ведущие мировые производители активных и пассивных электронных компонентов.

Нашей специализацией является поставка электронной компонентной базы двойного назначения, продукции таких производителей как XILINX, Intel (ex.ALTERA), Vicor, Microchip, Texas Instruments, Analog Devices, Mini-Circuits, Amphenol, Glenair.

Сотрудничество с глобальными дистрибьюторами электронных компонентов, предоставляет возможность заказывать и получать с международных складов практически любой перечень компонентов в оптимальные для Вас сроки.

На всех этапах разработки и производства наши партнеры могут получить квалифицированную поддержку опытных инженеров.

Система менеджмента качества компании отвечает требованиям в соответствии с ГОСТ Р ИСО 9001, ГОСТ РВ 0015-002 и ЭС РД 009

Офис по работе с юридическими лицами:

105318, г.Москва, ул.Щербаковская д.3, офис 1107, 1118, ДЦ «Щербаковский»

Телефон: +7 495 668-12-70 (многоканальный)

Факс: +7 495 668-12-70 (доб.304)

E-mail: info@moschip.ru

Skype отдела продаж:

moschip.ru

moschip.ru_4

moschip.ru_6

moschip.ru_9