



256K x 36, 512K x 18
9 Mb SYNCHRONOUS FLOW-THROUGH
STATIC RAM

SEPTEMBER 2010

FEATURES

- Internal self-timed write cycle
- Individual Byte Write Control and Global Write
- Clock controlled, registered address, data and control
- Burst sequence control using MODE input
- Three chip enable option for simple depth expansion and address pipelining
- Common data inputs and data outputs
- Auto Power-down during deselect
- Single cycle deselect
- Snooze MODE for reduced-power standby
- JTAG Boundary Scan for PBGA package
- Power Supply
 LF: $V_{DD} 3.3V \pm 5\%$, $V_{DDQ} 3.3V/2.5V \pm 5\%$
 VF: $V_{DD} 2.5V \pm 5\%$, $V_{DDQ} 2.5V \pm 5\%$
- JEDEC 100-Pin TQFP, 119-pin PBGA, and 165-pin PBGA packages
- Lead-free available
- Automotive temperature available

DESCRIPTION

The *ISSI* IS61LF/VF25636A, IS64LF25636A and IS61LF/VF51218A are high-speed, low-power synchronous static RAMs designed to provide burstable, high-performance memory for communication and networking applications. The IS61LF/VF25636A and IS64LF25636A are organized as 262,144 words by 36 bits. The IS61LF/VF51218A is organized as 524,288 words by 18 bits. Fabricated with *ISSI*'s advanced CMOS technology, the device integrates a 2-bit burst counter, high-speed SRAM core, and high-drive capability outputs into a single monolithic circuit. All synchronous inputs pass through registers controlled by a positive-edge-triggered single clock input.

Write cycles are internally self-timed and are initiated by the rising edge of the clock input. Write cycles can be one to four bytes wide as controlled by the write control inputs.

Separate byte enables allow individual bytes to be written. Byte write operation is performed by using byte write enable (\overline{BWE}) input combined with one or more individual byte write signals (\overline{BWx}). In addition, Global Write (\overline{GW}) is available for writing all bytes at one time, regardless of the byte write controls.

Bursts can be initiated with either \overline{ADSP} (Address Status Processor) or \overline{ADSC} (Address Status Cache Controller) input pins. Subsequent burst addresses can be generated internally and controlled by the \overline{ADV} (burst address advance) input pin.

The mode pin is used to select the burst sequence order, Linear burst is achieved when this pin is tied LOW. Interleave burst is achieved when this pin is tied HIGH or left floating.

FAST ACCESS TIME

Symbol	Parameter	-6.5	-7.5	Units
tkQ	Clock Access Time	6.5	7.5	ns
tkC	Cycle Time	7.5	8.5	ns
	Frequency	133	117	MHz

Copyright © 2010 Integrated Silicon Solution, Inc. All rights reserved. ISSI reserves the right to make changes to this specification and its products at any time without notice. ISSI assumes no liability arising out of the application or use of any information, products or services described herein. Customers are advised to obtain the latest version of this device specification before relying on any published information and before placing orders for products.

Integrated Silicon Solution, Inc. does not recommend the use of any of its products in life support applications where the failure or malfunction of the product can reasonably be expected to cause failure of the life support system or to significantly affect its safety or effectiveness. Products are not authorized for use in such applications unless Integrated Silicon Solution, Inc. receives written assurance to its satisfaction, that:

- a.) the risk of injury or damage has been minimized;
- b.) the user assume all such risks; and
- c.) potential liability of Integrated Silicon Solution, Inc is adequately protected under the circumstances



BLOCK DIAGRAM



165-PIN BGA

165-Ball, 13x15 mm BGA



119-PIN BGA

119-Ball, 14x22 mm BGA





119 BGA PACKAGE PIN CONFIGURATION-256K x 36 (TOP VIEW)

	1	2	3	4	5	6	7
A	V _{DDQ}	A	A	\overline{ADSP}	A	A	V _{DDQ}
B	NC	CE2	A	\overline{ADSC}	A	A	NC
C	NC	A	A	V _{DD}	A	A	NC
D	DQ _c	DQP _c	V _{SS}	NC	V _{SS}	DQP _b	DQ _b
E	DQ _c	DQ _c	V _{SS}	\overline{CE}	V _{SS}	DQ _b	DQ _b
F	V _{DDQ}	DQ _c	V _{SS}	\overline{OE}	V _{SS}	DQ _b	V _{DDQ}
G	DQ _c	DQ _c	\overline{BWc}	\overline{ADV}	\overline{BWb}	DQ _b	DQ _b
H	DQ _c	DQ _c	V _{SS}	\overline{GW}	V _{SS}	DQ _b	DQ _b
J	V _{DDQ}	V _{DD}	NC	V _{DD}	NC	V _{DD}	V _{DDQ}
K	DQ _d	DQ _d	V _{SS}	CLK	V _{SS}	DQ _a	DQ _a
L	DQ _d	DQ _d	\overline{BWd}	NC	\overline{BWa}	DQ _a	DQ _a
M	V _{DDQ}	DQ _d	V _{SS}	\overline{BWE}	V _{SS}	DQ _a	V _{DDQ}
N	DQ _d	DQ _d	V _{SS}	A ₁ *	V _{SS}	DQ _a	DQ _a
P	DQ _d	DQP _d	V _{SS}	A ₀ *	V _{SS}	DQP _a	DQ _a
R	NC	A	MODE	V _{DD}	NC	A	NC
T	NC	NC	A	A	A	NC	ZZ
U	V _{DDQ}	TMS	TDI	TCK	TDO	NC	V _{DDQ}

Note: * A₀ and A₁ are the two least significant bits (LSB) of the address field and set the internal burst counter if burst is desired.

PIN DESCRIPTIONS

Symbol	Pin Name
A	Address Inputs
A0, A1	Synchronous Burst Address Inputs
\overline{ADV}	Synchronous Burst Address Advance
\overline{ADSP}	Address Status Processor
\overline{ADSC}	Address Status Controller
\overline{GW}	Global Write Enable
CLK	Synchronous Clock
\overline{CE} , CE2	Synchronous Chip Select
\overline{BWx} (x=a-d)	Synchronous Byte Write Controls
\overline{BWE}	Byte Write Enable

Symbol	Pin Name
\overline{OE}	Output Enable
ZZ	Power Sleep Mode
MODE	Burst Sequence Selection
TCK, TDO	JTAG Pins
TMS, TDI	
NC	No Connect
DQ _a -DQ _d	Data Inputs/Outputs
DQP _a -Pd	Output Power Supply
V _{DD}	Power Supply
V _{DDQ}	Output Power Supply
V _{SS}	Ground

119 BGA PACKAGE PIN CONFIGURATION

512Kx18 (TOP VIEW)

	1	2	3	4	5	6	7
A	V _{DDQ}	A	A	$\overline{\text{ADSP}}$	A	A	V _{DDQ}
B	NC	CE2	A	$\overline{\text{ADSC}}$	A	A	NC
C	NC	A	A	V _{DD}	A	A	NC
D	DQb	NC	V _{SS}	NC	V _{SS}	DQPa	NC
E	NC	DQb	V _{SS}	$\overline{\text{CE}}$	V _{SS}	NC	DQa
F	V _{DDQ}	NC	V _{SS}	$\overline{\text{OE}}$	V _{SS}	DQa	V _{DDQ}
G	NC	DQb	$\overline{\text{BWb}}$	$\overline{\text{ADV}}$	V _{SS}	NC	DQa
H	DQb	NC	V _{SS}	$\overline{\text{GW}}$	V _{SS}	DQa	NC
J	V _{DDQ}	V _{DD}	NC	V _{DD}	NC	V _{DD}	V _{DDQ}
K	NC	DQb	V _{SS}	CLK	V _{SS}	NC	DQa
L	DQb	NC	V _{SS}	NC	$\overline{\text{BWA}}$	DQa	NC
M	V _{DDQ}	DQb	V _{SS}	$\overline{\text{BWE}}$	V _{SS}	NC	V _{DDQ}
N	DQb	NC	V _{SS}	A ₁ *	V _{SS}	DQa	NC
P	NC	DQPb	V _{SS}	A ₀ *	V _{SS}	NC	DQa
R	NC	A	MODE	V _{DD}	NC	A	NC
T	NC	A	A	NC	A	A	ZZ
U	V _{DDQ}	TMS	TDI	TCK	TDO	NC	V _{DDQ}

Note: * A₀ and A₁ are the two least significant bits (LSB) of the address field and set the internal burst counter if burst is desired.

PIN DESCRIPTIONS

Symbol	Pin Name
A	Address Inputs
A0, A1	Synchronous Burst Address Inputs
$\overline{\text{ADV}}$	Synchronous Burst Address Advance
$\overline{\text{ADSP}}$	Address Status Processor
$\overline{\text{ADSC}}$	Address Status Controller
$\overline{\text{GW}}$	Global Write Enable
CLK	Synchronous Clock
$\overline{\text{CE}}$, CE2	Synchronous Chip Select
$\overline{\text{BWx}}$ (x=a,b)	Synchronous Byte Write Controls
$\overline{\text{BWE}}$	Byte Write Enable

Symbol	Pin Name
$\overline{\text{OE}}$	Output Enable
ZZ	Power Sleep Mode
MODE	Burst Sequence Selection
TCK, TDO	JTAG Pins
TMS, TDI	
NC	No Connect
DQa-DQb	Data Inputs/Outputs
DQPa-Pb	Output Power Supply
V _{DD}	Power Supply
V _{DDQ}	Output Power Supply
V _{SS}	Ground



165 PBGA PACKAGE PIN CONFIGURATION

256K x 36 (TOP VIEW)

	1	2	3	4	5	6	7	8	9	10	11
A	NC	A	\overline{CE}	\overline{BWc}	\overline{BWb}	$\overline{CE2}$	\overline{BWE}	\overline{ADSC}	\overline{ADV}	A	NC
B	NC	A	CE2	\overline{BWd}	\overline{BWa}	CLK	\overline{GW}	\overline{OE}	\overline{ADSP}	A	NC
C	DQPc	NC	VDDQ	Vss	Vss	Vss	Vss	Vss	VDDQ	NC	DQPb
D	DQc	DQc	VDDQ	VDD	Vss	Vss	Vss	VDD	VDDQ	DQb	DQb
E	DQc	DQc	VDDQ	VDD	Vss	Vss	Vss	VDD	VDDQ	DQb	DQb
F	DQc	DQc	VDDQ	VDD	Vss	Vss	Vss	VDD	VDDQ	DQb	DQb
G	DQc	DQc	VDDQ	VDD	Vss	Vss	Vss	VDD	VDDQ	DQb	DQb
H	NC	Vss	NC	VDD	Vss	Vss	Vss	VDD	NC	NC	ZZ
J	DQd	DQd	VDDQ	VDD	Vss	Vss	Vss	VDD	VDDQ	DQa	DQa
K	DQd	DQd	VDDQ	VDD	Vss	Vss	Vss	VDD	VDDQ	DQa	DQa
L	DQd	DQd	VDDQ	VDD	Vss	Vss	Vss	VDD	VDDQ	DQa	DQa
M	DQd	DQd	VDDQ	VDD	Vss	Vss	Vss	VDD	VDDQ	DQa	DQa
N	DQPd	NC	VDDQ	Vss	NC	NC	NC	Vss	VDDQ	NC	DQPd
P	NC	NC	A	A	TDI	A1*	TDO	A	A	A	A
R	MODE	NC	A	A	TMS	A0*	TCK	A	A	A	A

Note: * A0 and A1 are the two least significant bits (LSB) of the address field and set the internal burst counter if burst is desired.

PIN DESCRIPTIONS

Symbol	Pin Name
A	Address Inputs
A0, A1	Synchronous Burst Address Inputs
\overline{ADV}	Synchronous Burst Address Advance
\overline{ADSP}	Address Status Processor
\overline{ADSC}	Address Status Controller
\overline{GW}	Global Write Enable
CLK	Synchronous Clock
\overline{CE} , $\overline{CE2}$, CE2	Synchronous Chip Select
BWx (x=a,b,c,d)	Synchronous Byte Write Controls

Symbol	Pin Name
\overline{BWE}	Byte Write Enable
\overline{OE}	Output Enable
ZZ	Power Sleep Mode
MODE	Burst Sequence Selection
TCK, TDO TMS, TDI	JTAG Pins
NC	No Connect
DQx	Data Inputs/Outputs
DQPx	Data Inputs/Outputs
VDD	3.3V/2.5V Power Supply
VDDQ	Isolated Output Power Supply 3.3V/2.5V
Vss	Ground

165 PBGA PACKAGE PIN CONFIGURATION

512K x 18 (TOP VIEW)

	1	2	3	4	5	6	7	8	9	10	11
A	NC	A	\overline{CE}	\overline{BWb}	NC	$\overline{CE2}$	\overline{BWE}	\overline{ADSC}	\overline{ADV}	A	A
B	NC	A	CE2	NC	\overline{BWa}	CLK	\overline{GW}	\overline{OE}	\overline{ADSP}	A	NC
C	NC	NC	V _{DDQ}	V _{SS}	V _{SS}	V _{SS}	V _{SS}	V _{SS}	V _{DDQ}	NC	DQP _a
D	NC	DQ _b	V _{DDQ}	V _{DD}	V _{SS}	V _{SS}	V _{SS}	V _{DD}	V _{DDQ}	NC	DQ _a
E	NC	DQ _b	V _{DDQ}	V _{DD}	V _{SS}	V _{SS}	V _{SS}	V _{DD}	V _{DDQ}	NC	DQ _a
F	NC	DQ _b	V _{DDQ}	V _{DD}	V _{SS}	V _{SS}	V _{SS}	V _{DD}	V _{DDQ}	NC	DQ _a
G	NC	DQ _b	V _{DDQ}	V _{DD}	V _{SS}	V _{SS}	V _{SS}	V _{DD}	V _{DDQ}	NC	DQ _a
H	NC	V _{SS}	NC	V _{DD}	V _{SS}	V _{SS}	V _{SS}	V _{DD}	NC	NC	ZZ
J	DQ _b	NC	V _{DDQ}	V _{DD}	V _{SS}	V _{SS}	V _{SS}	V _{DD}	V _{DDQ}	DQ _a	NC
K	DQ _b	NC	V _{DDQ}	V _{DD}	V _{SS}	V _{SS}	V _{SS}	V _{DD}	V _{DDQ}	DQ _a	NC
L	DQ _b	NC	V _{DDQ}	V _{DD}	V _{SS}	V _{SS}	V _{SS}	V _{DD}	V _{DDQ}	DQ _a	NC
M	DQ _b	NC	V _{DDQ}	V _{DD}	V _{SS}	V _{SS}	V _{SS}	V _{DD}	V _{DDQ}	DQ _a	NC
N	DQP _b	NC	V _{DDQ}	V _{SS}	NC	NC	NC	V _{SS}	V _{DDQ}	NC	NC
P	NC	NC	A	A	TDI	A1*	TDO	A	A	A	A
R	MODE	NC	A	A	TMS	A0*	TCK	A	A	A	A

Note: * A₀ and A₁ are the two least significant bits (LSB) of the address field and set the internal burst counter if burst is desired.

PIN DESCRIPTIONS

Symbol	Pin Name
A	Address Inputs
A ₀ , A ₁	Synchronous Burst Address Inputs
\overline{ADV}	Synchronous Burst Address Advance
\overline{ADSP}	Address Status Processor
\overline{ADSC}	Address Status Controller
\overline{GW}	Global Write Enable
CLK	Synchronous Clock
\overline{CE} , $\overline{CE2}$, CE2	Synchronous Chip Select
\overline{BWx} (x=a,b)	Synchronous Byte Write Controls

Symbol	Pin Name
\overline{BWE}	Byte Write Enable
\overline{OE}	Output Enable
ZZ	Power Sleep Mode
MODE	Burst Sequence Selection
TCK, TDO TMS, TDI	JTAG Pins
NC	No Connect
DQ _x	Data Inputs/Outputs
DQP _x	Data Inputs/Outputs
V _{DD}	3.3V/2.5V Power Supply
V _{DDQ}	Isolated Output Power Supply 3.3V/2.5V
V _{SS}	Ground

PIN CONFIGURATION

100-PIN TQFP (256K X 36)



(3 Chip-Enable option)

(2 Chip-Enable option)

PIN DESCRIPTIONS

A0, A1	Synchronous Address Inputs. These pins must be tied to the two LSBs of the address bus.
A	Synchronous Address Inputs
ADSC	Synchronous Controller Address Status
ADSP	Synchronous Processor Address Status
ADV	Synchronous Burst Address Advance
BWa-BWd	Synchronous Byte Write Enable
BWE	Synchronous Byte Write Enable
CE, CE2, CE2	Synchronous Chip Enable
CLK	Synchronous Clock

DQa-DQd	Synchronous Data Input/Output
DQPa-DQPd	Parity Data Input/Output
GW	Synchronous Global Write Enable
MODE	Burst Sequence Mode Selection
OE	Output Enable
VDD	3.3V/2.5V Power Supply
VDDQ	Isolated Output Buffer Supply: 3.3V/2.5V
VSS	Ground
ZZ	Snooze Enable

PIN CONFIGURATION

100-PIN TQFP (512K X 18)

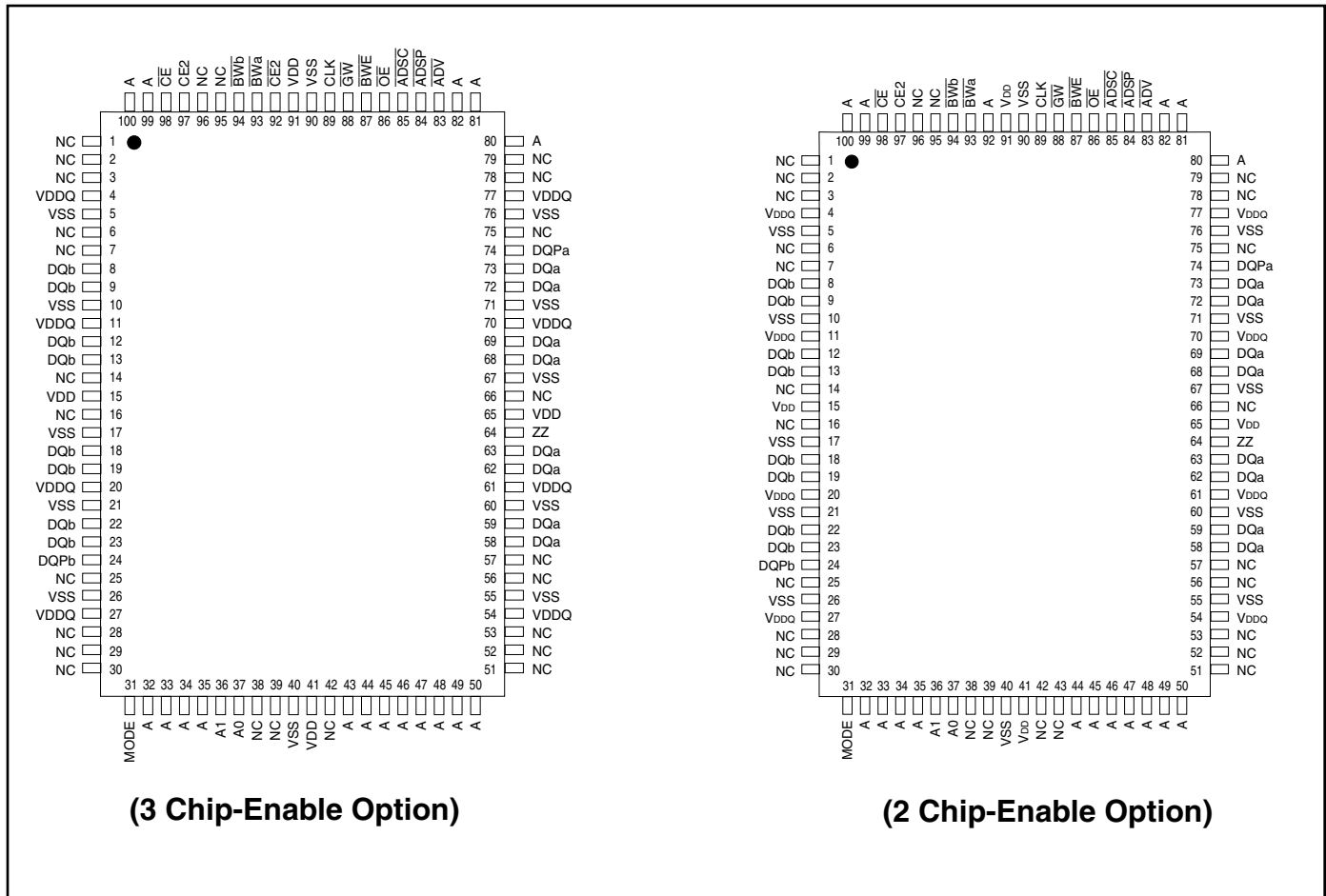

PIN DESCRIPTIONS

A0, A1	Synchronous Address Inputs. These pins must tied to the two LSBs of the address bus.	DQPb-DQPa	Parity Data I/O; DQPb is parity for DQb1-8; DQPa is parity for DQa1-8
A	Synchronous Address Inputs	\overline{GW}	Synchronous Global Write Enable
\overline{ADSC}	Synchronous Controller Address Status	MODE	Burst Sequence Mode Selection
\overline{ADSP}	Synchronous Processor Address Status	\overline{OE}	Output Enable
\overline{ADV}	Synchronous Burst Address Advance	VDD	3.3V/2.5V Power Supply
$\overline{BWA-BWb}$	Synchronous Byte Write Enable	VDDQ	Isolated Output Buffer Supply: 3.3V/2.5V
\overline{BWE}	Synchronous Byte Write Enable	Vss	Ground
$\overline{CE}, \overline{CE2}, \overline{CE2}$	Synchronous Chip Enable	\overline{ZZ}	Snooze Enable
CLK	Synchronous Clock		
DQa-DQb	Synchronous Data Input/Output		



TRUTH TABLE⁽¹⁻⁸⁾

OPERATION	ADDRESS	\overline{CE}	$\overline{CE2}$	CE2	ZZ	\overline{ADSP}	\overline{ADSC}	\overline{ADV}	WRITE	\overline{OE}	CLK	DQ
Deselect Cycle, Power-Down	None	H	X	X	L	X	L	X	X	X	L-H	High-Z
Deselect Cycle, Power-Down	None	L	X	L	L	L	X	X	X	X	L-H	High-Z
Deselect Cycle, Power-Down	None	L	H	X	L	L	X	X	X	X	L-H	High-Z
Deselect Cycle, Power-Down	None	L	X	L	L	H	L	X	X	X	L-H	High-Z
Deselect Cycle, Power-Down	None	L	H	X	L	H	L	X	X	X	L-H	High-Z
Snooze Mode, Power-Down	None	X	X	X	H	X	X	X	X	X	X	High-Z
Read Cycle, Begin Burst	External	L	L	H	L	L	X	X	X	L	L-H	Q
Read Cycle, Begin Burst	External	L	L	H	L	L	X	X	X	H	L-H	High-Z
Write Cycle, Begin Burst	External	L	L	H	L	H	L	X	L	X	L-H	D
Read Cycle, Begin Burst	External	L	L	H	L	H	L	X	H	L	L-H	Q
Read Cycle, Begin Burst	External	L	L	H	L	H	L	X	H	H	L-H	High-Z
Read Cycle, Continue Burst	Next	X	X	X	L	H	H	L	H	L	L-H	Q
Read Cycle, Continue Burst	Next	X	X	X	L	H	H	L	H	H	L-H	High-Z
Read Cycle, Continue Burst	Next	H	X	X	L	X	H	L	H	L	L-H	Q
Read Cycle, Continue Burst	Next	H	X	X	L	X	H	L	H	H	L-H	High-Z
Write Cycle, Continue Burst	Next	X	X	X	L	H	H	L	L	X	L-H	D
Write Cycle, Continue Burst	Next	H	X	X	L	X	H	L	L	X	L-H	D
Read Cycle, Suspend Burst	Current	X	X	X	L	H	H	H	H	L	L-H	Q
Read Cycle, Suspend Burst	Current	X	X	X	L	H	H	H	H	H	L-H	High-Z
Read Cycle, Suspend Burst	Current	H	X	X	L	X	H	H	H	L	L-H	Q
Read Cycle, Suspend Burst	Current	H	X	X	L	X	H	H	H	H	L-H	High-Z
Write Cycle, Suspend Burst	Current	X	X	X	L	H	H	H	L	X	L-H	D
Write Cycle, Suspend Burst	Current	H	X	X	L	X	H	H	L	X	L-H	D

NOTE:

1. X means “Don’t Care.” H means logic HIGH. L means logic LOW.
2. For WRITE, L means one or more byte write enable signals ($\overline{BWA-d}$) and \overline{BWE} are LOW or \overline{GW} is LOW. WRITE = H for all \overline{BWx} , \overline{BWE} , \overline{GW} HIGH.
3. \overline{BWA} enables WRITES to DQa’s and DQPa. \overline{BWb} enables WRITES to DQb’s and DQPb. \overline{BWC} enables WRITES to DQc’s and DQPc. \overline{BWD} enables WRITES to DQd’s and DQPd. DQPa and DQPb are available on the x18 version. DQPa-DQPd are available on the x36 version.
4. All inputs except \overline{OE} and ZZ must meet setup and hold times around the rising edge (LOW to HIGH) of CLK.
5. Wait states are inserted by suspending burst.
6. For a WRITE operation following a READ operation, \overline{OE} must be HIGH before the input data setup time and held HIGH during the input data hold time.
7. This device contains circuitry that will ensure the outputs will be in High-Z during power-up.
8. \overline{ADSP} LOW always initiates an internal READ at the L-H edge of CLK. A WRITE is performed by setting one or more byte write enable signals and \overline{BWE} LOW or \overline{GW} LOW for the subsequent L-H edge of CLK. See WRITE timing diagram for clarification.

PARTIAL TRUTH TABLE

Function	\overline{GW}	\overline{BWE}	\overline{BWA}	\overline{BWb}	\overline{BWC}	\overline{BWD}
Read	H	H	X	X	X	X
Read	H	L	H	H	H	H
Write Byte 1	H	L	L	H	H	H
Write All Bytes	H	L	L	L	L	L
Write All Bytes	L	X	X	X	X	X

INTERLEAVED BURST ADDRESS TABLE (MODE = V_{DD} or No Connect)

External Address A1 A0	1st Burst Address A1 A0	2nd Burst Address A1 A0	3rd Burst Address A1 A0
00	01	10	11
01	00	11	10
10	11	00	01
11	10	01	00

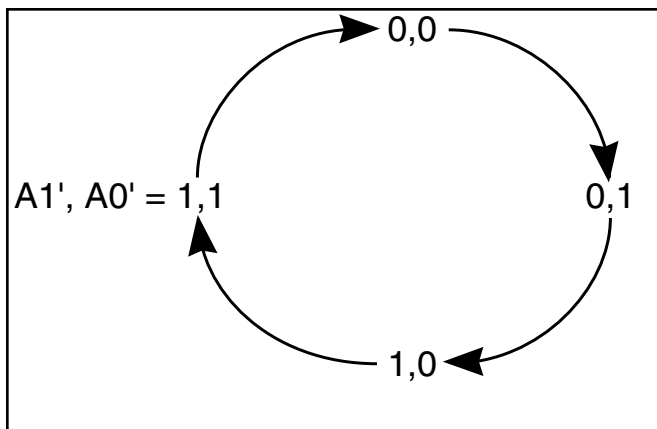
LINEAR BURST ADDRESS TABLE (MODE = V_{SS})

ABSOLUTE MAXIMUM RATINGS⁽¹⁾

Symbol	Parameter	Value	Unit
T _{STG}	Storage Temperature	-55 to +150	°C
P _D	Power Dissipation	1.6	W
I _{OUT}	Output Current (per I/O)	100	mA
V _{IN} , V _{OUT}	Voltage Relative to V _{SS} for I/O Pins	-0.5 to V _{DDQ} + 0.5	V
V _{IN}	Voltage Relative to V _{SS} for for Address and Control Inputs	-0.5 to V _{DD} + 0.5	V
V _{DD}	Voltage on V _{DD} Supply Relative to V _{SS}	-0.5 to 4.6	V

Notes:

1. Stress greater than those listed under ABSOLUTE MAXIMUM RATINGS may cause permanent damage to the device. This is a stress rating only and functional operation of the device at these or any other conditions above those indicated in the operational sections of this specification is not implied. Exposure to absolute maximum rating conditions for extended periods may affect reliability.
2. This device contains circuitry to protect the inputs against damage due to high static voltages or electric fields; however, precautions may be taken to avoid application of any voltage higher than maximum rated voltages to this high-impedance circuit.
3. This device contains circuitry that will ensure the output devices are in High-Z at power up.



IS61/64LF25636A IS61LF51218A IS61VF25636A IS61VF51218A

OPERATING RANGE (IS61LFxxxxx)

Range	Ambient Temperature	V _{DD}	V _{DDQ}
Commercial	0°C to +70°C	3.3V ± 5%	3.3V/2.5V ± 5%
Industrial	-40°C to +85°C	3.3V ± 5%	3.3V/2.5V ± 5%

OPERATING RANGE (IS64LFxxxxx)

Range	Ambient Temperature	V _{DD}	V _{DDQ}
Automotive	-40°C to +125°C	3.3V ± 5%	3.3V/2.5V ± 5%

OPERATING RANGE (IS61VFxxxxx)

Range	Ambient Temperature	V _{DD}	V _{DDQ}
Commercial	0°C to +70°C	2.5V ± 5%	2.5V ± 5%
Industrial	-40°C to +85°C	2.5V ± 5%	2.5V ± 5%

DC ELECTRICAL CHARACTERISTICS (Over Operating Range)

Symbol	Parameter	Test Conditions	3.3V		2.5V		Unit
			Min.	Max.	Min.	Max.	
V _{OH}	Output HIGH Voltage	I _{OH} = -4.0 mA (3.3V) I _{OH} = -1.0 mA (2.5V)	2.4	—	2.0	—	V
V _{OL}	Output LOW Voltage	I _{OL} = 8.0 mA (3.3V) I _{OL} = 1.0 mA (2.5V)	—	0.4	—	0.4	V
V _{IH}	Input HIGH Voltage		2.0	V _{DD} + 0.3	1.7	V _{DD} + 0.3	V
V _{IL}	Input LOW Voltage		-0.3	0.8	-0.3	0.7	V
I _{LI}	Input Leakage Current	V _{SS} ≤ V _{IN} ≤ V _{DD} ⁽¹⁾	-5	5	-5	5	μA
I _{LO}	Output Leakage Current	V _{SS} ≤ V _{OUT} ≤ V _{DDQ} , $\overline{OE} = V_{IH}$	-5	5	-5	5	μA

POWER SUPPLY CHARACTERISTICS⁽¹⁾ (Over Operating Range)

Symbol	Parameter	Test Conditions	Temp. range	6.5 MAX		7.5 MAX		Unit
				x18	x36	x18	x36	
I _{CC}	AC Operating Supply Current	Device Selected,	Com.	185	185	175	175	mA
		$\overline{OE} = V_{IH}$, ZZ ≤ V _{IL} ,	Ind.	190	190	185	185	
		All Inputs ≤ 0.2V or ≥ V _{DD} - 0.2V, Cycle Time ≥ t _{kc} min.	AUTO.			225	225	
I _{SB}	Standby Current TTL Input	Device Deselected,	Com.	140	140	140	140	mA
		V _{DD} = Max.,	Ind.	150	150	150	150	
		All Inputs ≤ V _{IL} or ≥ V _{IH} , ZZ ≤ V _{IL} , f = Max.	AUTO.			150	150	
I _{SBI}	Standby Current CMOS Input	Device Deselected,	Com.	80	80	80	80	mA
		V _{DD} = Max.,	Ind.	85	85	85	85	
		V _{IN} ≤ V _{SS} + 0.2V or ≥ V _{DD} - 0.2V f = 0	AUTO.			130	130	

Note:

1. MODE pin has an internal pullup and should be tied to V_{DD} or V_{SS}. It exhibits ±100 μA maximum leakage current when tied to ≤ V_{SS} + 0.2V or ≥ V_{DD} - 0.2V.

CAPACITANCE^(1,2)

Symbol	Parameter	Conditions	Max.	Unit
C _{IN}	Input Capacitance	V _{IN} = 0V	6	pF
C _{OUT}	Input/Output Capacitance	V _{OUT} = 0V	8	pF

Notes:

1. Tested initially and after any design or process changes that may affect these parameters.
2. Test conditions: T_A = 25°C, f = 1 MHz, V_{DD} = 3.3V.

3.3V I/O AC TEST CONDITIONS

Parameter	Unit
Input Pulse Level	0V to 3.0V
Input Rise and Fall Times	1.5 ns
Input and Output Timing and Reference Level	1.5V
Output Load	See Figures 1 and 2

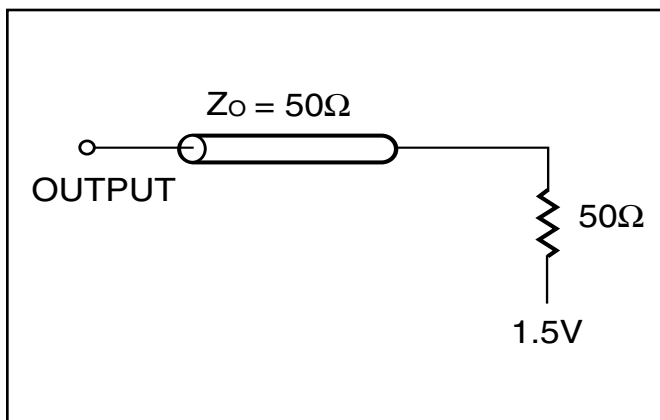
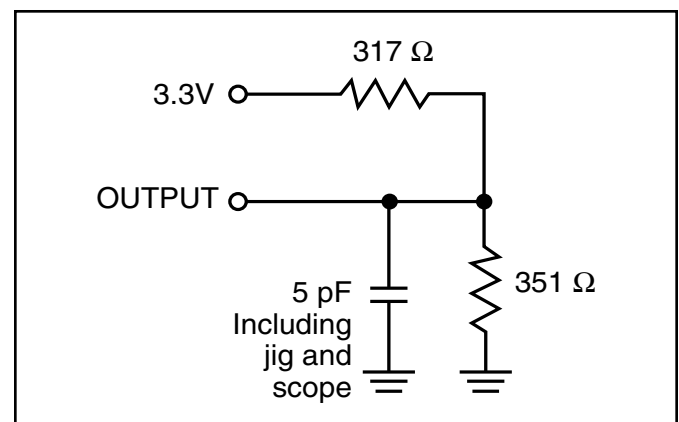
AC TEST LOADS

Figure 1

Figure 2

2.5V I/O AC TEST CONDITIONS

Parameter	Unit
Input Pulse Level	0V to 2.5V
Input Rise and Fall Times	1.5 ns
Input and Output Timing and Reference Level	1.25V
Output Load	See Figures 3 and 4

2.5V I/O OUTPUT LOAD EQUIVALENT



Figure 3



Figure 4

READ/WRITE CYCLE SWITCHING CHARACTERISTICS⁽¹⁾ (Over Operating Range)

Symbol	Parameter	6.5		7.5		Unit
		Min.	Max.	Min.	Max.	
fmax	Clock Frequency	—	133	—	117	MHz
t _{kc}	Cycle Time	7.5	—	8.5	—	ns
t _{kh}	Clock High Time	2.2	—	2.5	—	ns
t _{kl}	Clock Low Time	2.2	—	2.5	—	ns
t _{kq}	Clock Access Time	—	6.5	—	7.5	ns
t _{kqx} ⁽²⁾	Clock High to Output Invalid	2.5	—	2.5	—	ns
t _{kqlz} ^(2,3)	Clock High to Output Low-Z	2.5	—	2.5	—	ns
t _{kqhz} ^(2,3)	Clock High to Output High-Z	—	3.8	—	4.0	ns
t _{oeq}	Output Enable to Output Valid	—	3.2	—	3.4	ns
t _{oelz} ^(2,3)	Output Enable to Output Low-Z	0	—	0	—	ns
t _{oehz} ^(2,3)	Output Disable to Output High-Z	—	3.5	—	3.5	ns
t _{as}	Address Setup Time	1.5	—	1.5	—	ns
t _{ss}	Address Status Setup Time	1.5	—	1.5	—	ns
t _{ws}	Read/Write Setup Time	1.5	—	1.5	—	ns
t _{ces}	Chip Enable Setup Time	1.5	—	1.5	—	ns
t _{avs}	Address Advance Setup Time	1.5	—	1.5	—	ns
t _{ds}	Data Setup Time	1.5	—	1.5	—	ns
t _{ah}	Address Hold Time	0.5	—	0.5	—	ns
t _{sh}	Address Status Hold Time	0.5	—	0.5	—	ns
t _{wh}	Write Hold Time	0.5	—	0.5	—	ns
t _{ceh}	Chip Enable Hold Time	0.5	—	0.5	—	ns
t _{avh}	Address Advance Hold Time	0.5	—	0.5	—	ns
t _{dh}	Data Hold Time	0.5	—	0.5	—	ns

Notes:

1. Configuration signal MODE is static and must not change during normal operation.
2. Guaranteed but not 100% tested. This parameter is periodically sampled.
3. Tested with load in Figure 2.

READ/WRITE CYCLE TIMING



WRITE CYCLE TIMING

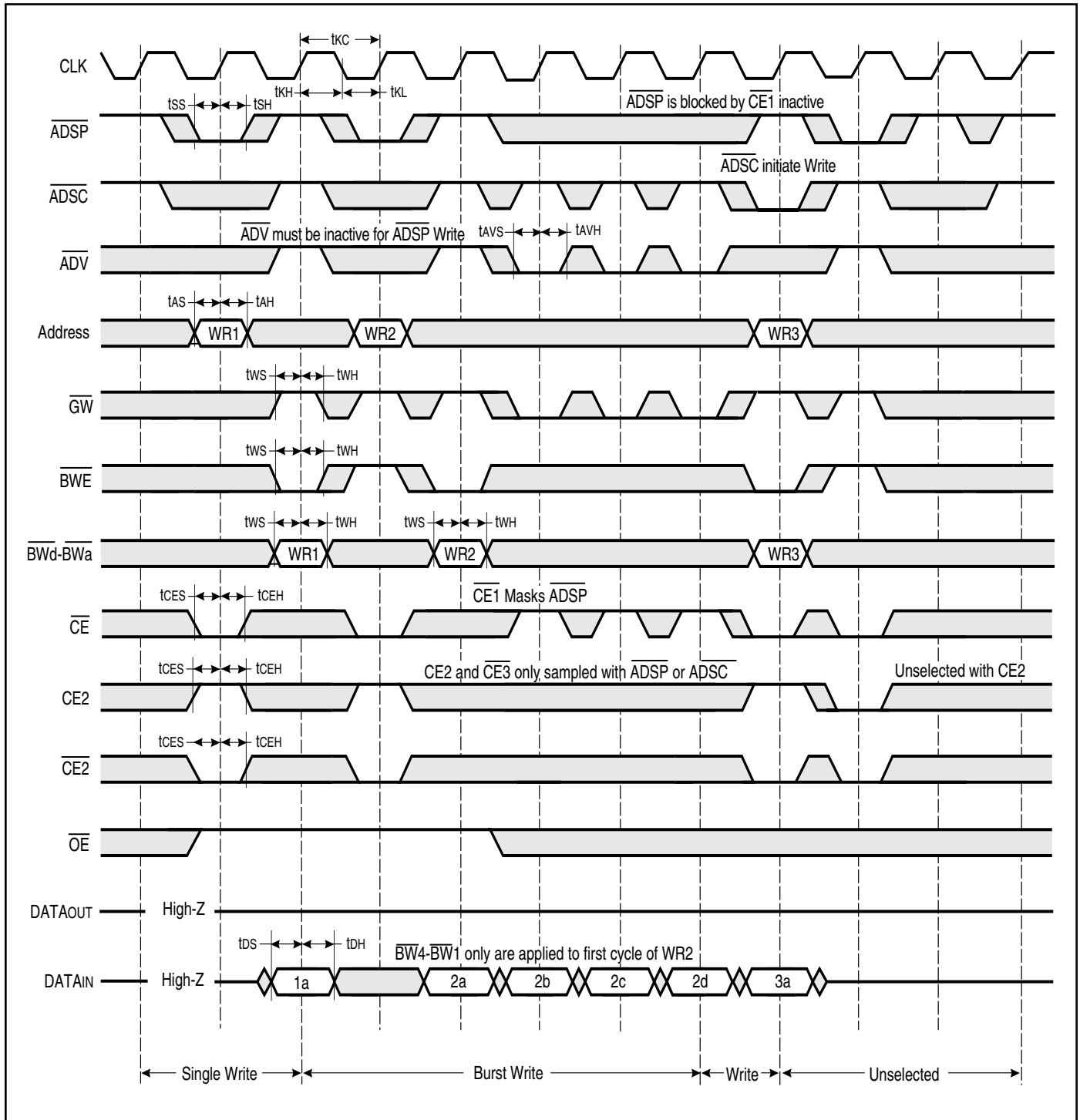



SNOOZE MODE ELECTRICAL CHARACTERISTICS

Symbol	Parameter	Conditions	Temp. Range	Min.	Max.	Unit
ISB2	Current during SNOOZE MODE	ZZ ≥ Vih	Com.	—	55	mA
			Ind.	—	60	
			Auto.	—	95	
tPDS	ZZ active to input ignored			—	2	cycle
tPUS	ZZ inactive to input sampled			2	—	cycle
tZZI	ZZ active to SNOOZE current			—	2	cycle
tRZZI	ZZ inactive to exit SNOOZE current			0	—	ns

SNOOZE MODE TIMING

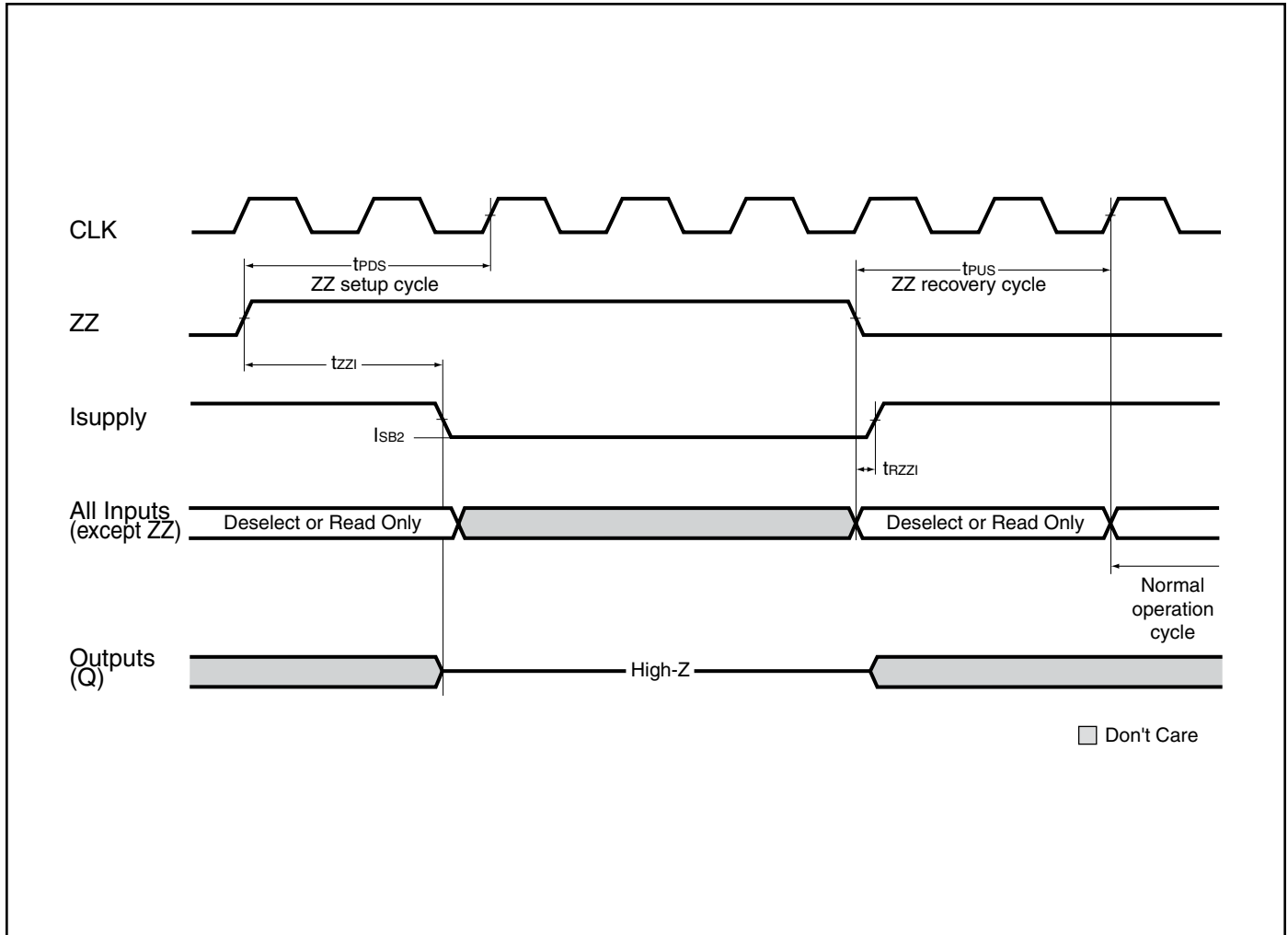

IEEE 1149.1 SERIAL BOUNDARY SCAN (JTAG)

The IS61LF/VF25636A and IS61LF/VF51218A have a serial boundary scan Test Access Port (TAP) in the PBGA package only. This port operates in accordance with IEEE Standard 1149.1-1900, but does not include all functions required for full 1149.1 compliance. These functions from the IEEE specification are excluded because they place added delay in the critical speed path of the SRAM. The TAP controller operates in a manner that does not conflict with the performance of other devices using 1149.1 fully compliant TAPs. The TAP operates using JEDEC standard 2.5V I/O logic levels.

DISABLING THE JTAG FEATURE

The SRAM can operate without using the JTAG feature. To disable the TAP controller, TCK must be tied LOW (V_{SS}) to prevent clocking of the device. TDI and TMS are internally pulled up and may be disconnected. They may alternately be connected to V_{DD} through a pull-up resistor. TDO should be left disconnected. On power-up, the device will start in a reset state which will not interfere with the device operation.

TEST ACCESS PORT (TAP) - TEST CLOCK

The test clock is only used with the TAP controller. All inputs are captured on the rising edge of TCK and outputs are driven from the falling edge of TCK.

TEST MODE SELECT (TMS)

The TMS input is used to send commands to the TAP controller and is sampled on the rising edge of TCK. This pin may be left disconnected if the TAP is not used. The pin is internally pulled up, resulting in a logic HIGH level.

TEST DATA-IN (TDI)

The TDI pin is used to serially input information to the registers and can be connected to the input of any register. The register between TDI and TDO is chosen by the instruction loaded into the TAP instruction register. For information on instruction register loading, see the TAP Controller State Diagram. TDI is internally pulled up and can be disconnected if the TAP is unused in an application. TDI is connected to the Most Significant Bit (MSB) on any register.

TAP CONTROLLER BLOCK DIAGRAM





TEST DATA OUT (TDO)

The TDO output pin is used to serially clock data-out from the registers. The output is active depending on the current state of the TAP state machine (see TAP Controller State Diagram). The output changes on the falling edge of TCK and TDO is connected to the Least Significant Bit (LSB) of any register.

PERFORMING A TAP RESET

A Reset is performed by forcing TMS HIGH (V_{DD}) for five rising edges of TCK. RESET may be performed while the SRAM is operating and does not affect its operation. At power-up, the TAP is internally reset to ensure that TDO comes up in a high-Z state.

TAP REGISTERS

Registers are connected between the TDI and TDO pins and allow data to be scanned into and out of the SRAM test circuitry. Only one register can be selected at a time through the instruction registers. Data is serially loaded into the TDI pin on the rising edge of TCK and output on the TDO pin on the falling edge of TCK.

Instruction Register

Three-bit instructions can be serially loaded into the instruction register. This register is loaded when it is placed between the TDI and TDO pins. (See TAP Controller Block Diagram) At power-up, the instruction register is loaded with the IDCODE instruction. It is also loaded with the IDCODE instruction if the controller is placed in a reset state as previously described.

When the TAP controller is in the CaptureIR state, the two least significant bits are loaded with a binary “01” pattern to allow for fault isolation of the board level serial test path.

Bypass Register

To save time when serially shifting data through registers, it is sometimes advantageous to skip certain states. The bypass register is a single-bit register that can be placed between TDI and TDO pins. This allows data to be shifted through the SRAM with minimal delay. The bypass register is set LOW (V_{SS}) when the BYPASS instruction is executed.

IDENTIFICATION REGISTER DEFINITIONS

Instruction Field	Description	256K x 36	512K x 18
Revision Number (31:28)	Reserved for version number.	xxxx	xxxx
Device Depth (27:23)	Defines depth of SRAM. 256K or 512K	00111	01000
Device Width (22:18)	Defines width of the SRAM. x36 or x18	00100	00011
ISSI Device ID (17:12)	Reserved for future use.	xxxxx	xxxxx
ISSI JEDEC ID (11:1)	Allows unique identification of SRAM vendor.	00011010101	00011010101
ID Register Presence (0)	Indicate the presence of an ID register.	1	1

Boundary Scan Register

The boundary scan register is connected to all input and output pins on the SRAM. Several no connect (NC) pins are also included in the scan register to reserve pins for higher density devices. The x36 configuration has a 75-bit-long register and the x18 configuration also has a 75-bit-long register. The boundary scan register is loaded with the contents of the RAM Input and Output ring when the TAP controller is in the Capture-DR state and then placed between the TDI and TDO pins when the controller is moved to the Shift-DR state. The EXTEST, SAMPLE/PRELOAD and SAMPLE-Z instructions can be used to capture the contents of the Input and Output ring.

The Boundary Scan Order tables show the order in which the bits are connected. Each bit corresponds to one of the bumps on the SRAM package. The MSB of the register is connected to TDI, and the LSB is connected to TDO.

Scan Register Sizes

Register Name	Bit Size (x18)	Bit Size (x36)
Instruction	3	3
Bypass	1	1
ID	32	32
Boundary Scan	75	75

Identification (ID) Register

The ID register is loaded with a vendor-specific, 32-bit code during the Capture-DR state when the IDCODE command is loaded to the instruction register. The IDCODE is hardwired into the SRAM and can be shifted out when the TAP controller is in the Shift-DR state. The ID register has vendor code and other information described in the Identification Register Definitions table.

TAP INSTRUCTION SET

Eight instructions are possible with the three-bit instruction register and all combinations are listed in the Instruction Code table. Three instructions are listed as RESERVED and should not be used and the other five instructions are described below. The TAP controller used in this SRAM is not fully compliant with the 1149.1 convention because some mandatory instructions are not fully implemented. The TAP controller cannot be used to load address, data or control signals and cannot preload the Input or Output buffers. The SRAM does not implement the 1149.1 commands EXTEST or INTEST or the PRELOAD portion of SAMPLE/PRELOAD; instead it performs a capture of the Inputs and Output ring when these instructions are executed. Instructions are loaded into the TAP controller during the Shift-IR state when the instruction register is placed between TDI and TDO. During this state, instructions are shifted from the instruction register through the TDI and TDO pins. To execute an instruction once it is shifted in, the TAP controller must be moved into the Update-IR state.

EXTEST

EXTEST is a mandatory 1149.1 instruction which is to be executed whenever the instruction register is loaded with all 0s. Because EXTEST is not implemented in the TAP controller, this device is not 1149.1 standard compliant. The TAP controller recognizes an all-0 instruction. When an EXTEST instruction is loaded into the instruction register, the SRAM responds as if a SAMPLE/PRELOAD instruction has been loaded. There is a difference between the instructions, unlike the SAMPLE/PRELOAD instruction, EXTEST places the SRAM outputs in a High-Z state.

IDCODE

The IDCODE instruction causes a vendor-specific, 32-bit code to be loaded into the instruction register. It also places the instruction register between the TDI and TDO pins and allows the IDCODE to be shifted out of the device when the TAP controller enters the Shift-DR state. The IDCODE instruction is loaded into the instruction register upon power-up or whenever the TAP controller is given a test logic reset state.

SAMPLE-Z

The SAMPLE-Z instruction causes the boundary scan register to be connected between the TDI and TDO pins when the TAP controller is in a Shift-DR state. It also places all SRAM outputs into a High-Z state.

SAMPLE/PRELOAD

SAMPLE/PRELOAD is a 1149.1 mandatory instruction. The PRELOAD portion of this instruction is not implemented, so the TAP controller is not fully 1149.1 compliant. When the SAMPLE/PRELOAD instruction is loaded to the instruction register and the TAP controller is in the Capture-DR state, a snapshot of data on the inputs and output pins is captured in the boundary scan register.

It is important to realize that the TAP controller clock operates at a frequency up to 10 MHz, while the SRAM clock runs more than an order of magnitude faster. Because of the clock frequency differences, it is possible that during the Capture-DR state, an input or output will under-go a transition. The TAP may attempt a signal capture while in transition (metastable state). The device will not be harmed, but there is no guarantee of the value that will be captured or repeatable results.

To guarantee that the boundary scan register will capture the correct signal value, the SRAM signal must be stabilized long enough to meet the TAP controller's capture set-up plus hold times (t_{CS} and t_{CH}). To insure that the SRAM clock input is captured correctly, designs need a way to stop (or slow) the clock during a SAMPLE/PRELOAD instruction. If this is not an issue, it is possible to capture all other signals and simply ignore the value of the CLK and \overline{CLK} captured in the boundary scan register.

Once the data is captured, it is possible to shift out the data by putting the TAP into the Shift-DR state. This places the boundary scan register between the TDI and TDO pins.

Note that since the PRELOAD part of the command is not implemented, putting the TAP into the Update to the Update-DR state while performing a SAMPLE/PRELOAD instruction will have the same effect as the Pause-DR command.

BYPASS

When the BYPASS instruction is loaded in the instruction register and the TAP is placed in a Shift-DR state, the bypass register is placed between the TDI and TDO pins. The advantage of the BYPASS instruction is that it shortens the boundary scan path when multiple devices are connected together on a board.

RESERVED

These instructions are not implemented but are reserved for future use. Do not use these instructions.



INSTRUCTION CODES

Code	Instruction	Description
000	EXTEST	Captures the Input/Output ring contents. Places the boundary scan register between the TDI and TDO. Forces all SRAM outputs to High-Z state. This instruction is not 1149.1 compliant.
001	IDCODE	Loads the ID register with the vendor ID code and places the register between TDI and TDO. This operation does not affect SRAM operation.
010	SAMPLE-Z	Captures the Input/Output contents. Places the boundary scan register between TDI and TDO. Forces all SRAM output drivers to a High-Z state.
011	RESERVED	Do Not Use: This instruction is reserved for future use.
100	SAMPLE/PRELOAD	Captures the Input/Output ring contents. Places the boundary scan register between TDI and TDO. Does not affect the SRAM operation. This instruction does not implement 1149.1 preload function and is therefore not 1149.1 compliant.
101	RESERVED	Do Not Use: This instruction is reserved for future use.
110	RESERVED	Do Not Use: This instruction is reserved for future use.
111	BYPASS	Places the bypass register between TDI and TDO. This operation does not affect SRAM operation.

TAP CONTROLLER STATE DIAGRAM



TAP Electrical Characteristics Over the Operating Range^(1,2)

Symbol	Parameter	Test Conditions	Min.	Max.	Units
V _{OH1}	Output HIGH Voltage	I _{OH} = -2.0 mA	1.7	—	V
V _{OH2}	Output HIGH Voltage	I _{OH} = -100 μA	2.1	—	V
V _{OL1}	Output LOW Voltage	I _{OL} = 2.0 mA	—	0.7	V
V _{OL2}	Output LOW Voltage	I _{OL} = 100 μA	—	0.2	V
V _{IH}	Input HIGH Voltage		1.7	V _{DD} +0.3	V
V _{IL}	Input LOW Voltage	I _{OLT} = 2mA	-0.3	0.7	V
I _x	Input Load Current	V _{SS} ≤ V _I ≤ V _{DDQ}	-5	5	mA

Notes:

- All Voltage referenced to Ground.
- Overshoot: V_{IH} (AC) ≤ V_{DD} +1.5V for t ≤ t_{trcyc}/2,
Undershoot: V_{IL} (AC) ≤ 0.5V for t ≤ t_{trcyc}/2,
Power-up: V_{IH} < 2.6V and V_{DD} < 2.4V and V_{DDQ} < 1.4V for t < 200 ms.

TAP AC ELECTRICAL CHARACTERISTICS^(1,2) (OVER OPERATING RANGE)

Symbol	Parameter	Min.	Max.	Unit
t _{trcyc}	TCK Clock cycle time	100	—	ns
f _{trf}	TCK Clock frequency	—	10	MHz
t _{trH}	TCK Clock HIGH	40	—	ns
t _{trL}	TCK Clock LOW	40	—	ns
t _{trMSS}	TMS setup to TCK Clock Rise	10	—	ns
t _{trDIS}	TDI setup to TCK Clock Rise	10	—	ns
t _{trCS}	Capture setup to TCK Rise	10	—	ns
t _{trMSH}	TMS hold after TCK Clock Rise	10	—	ns
t _{trDIH}	TDI Hold after Clock Rise	10	—	ns
t _{trCH}	Capture hold after Clock Rise	10	—	ns
t _{trDOV}	TCK LOW to TDO valid	—	20	ns
t _{trDOX}	TCK LOW to TDO invalid	0	—	ns

Notes:

- Both t_{trCS} and t_{trCH} refer to the set-up and hold time requirements of latching data from the boundary scan register.
- Test conditions are specified using the load in TAP AC test conditions. t_{tr}/t_{trF} = 1 ns.

TAP AC TEST CONDITIONS

Input pulse levels	0 to 2.5V/0 to 3.0V
Input rise and fall times	1ns
Input timing reference levels	1.25V/1.5V
Output reference levels	1.25V/1.5V
Test load termination supply voltage	1.25V/1.5V

TAP Output Load Equivalent



TAP TIMING

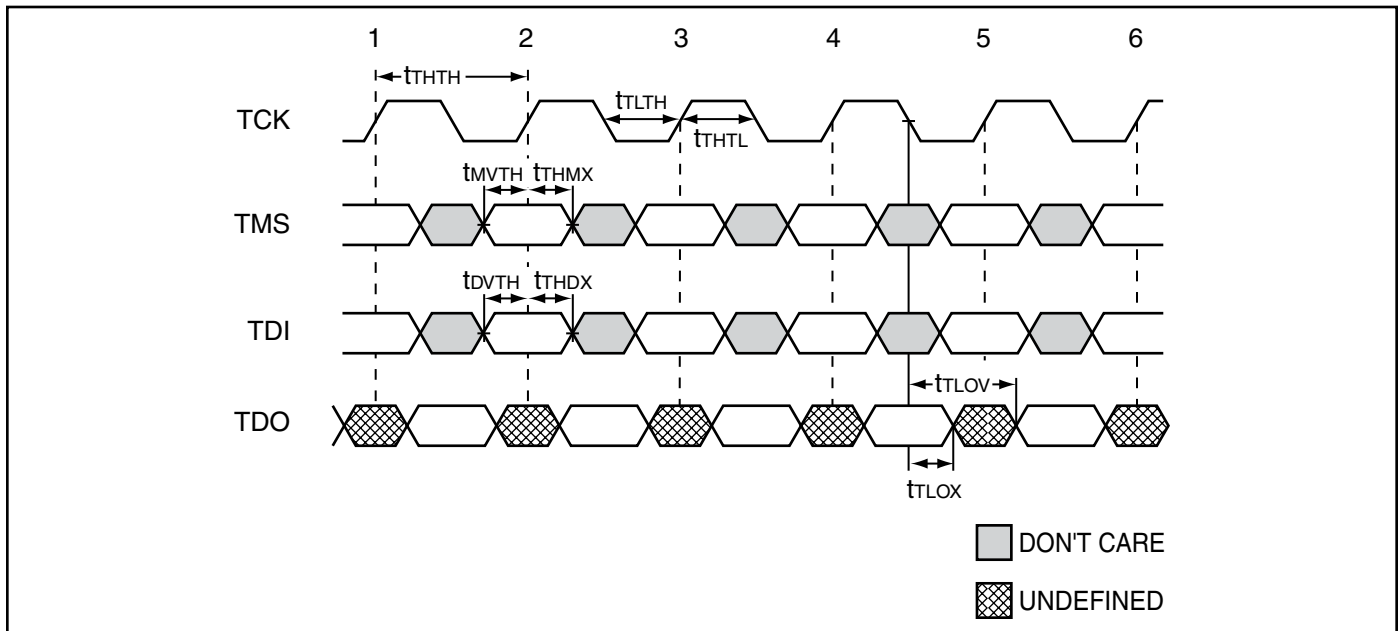

119 BGA BOUNDARY SCAN ORDER (256K X 36)

Bit #	Signal Name	Bump ID	Bit #	Signal Name	Bump ID	Bit #	Signal Name	Bump ID	Bit #	Signal Name	Bump ID
1	A	2R	19	DQb	7G	37	BWa	5L	55	DQd	2K
2	A	3T	20	DQb	6F	38	BWb	5G	56	DQd	1L
3	A	4T	21	DQb	7E	39	BWc	3G	57	DQd	2M
4	A	5T	22	DQb	7D	40	BWd	3L	58	DQd	1N
5	A	6R	23	DQb	7H	41	CE2	2B	59	DQd	1P
6	A	3B	24	DQb	6G	42	CE	4E	60	DQd	1K
7	A	5B	25	DQb	6E	43	A	3A	61	DQd	2L
8	DQa	6P	26	DQb	6D	44	A	2A	62	DQd	2N
9	DQa	7N	27	A	6A	45	DQc	2D	63	DQd	2P
10	DQa	6M	28	A	5A	46	DQc	1E	64	MODE	3R
11	DQa	7L	29	ADV	4G	47	DQc	2F	65	A	2C
12	DQa	6K	30	ADSP	4A	48	DQc	1G	66	A	3C
13	DQa	7P	31	ADSC	4B	49	DQc	2H	67	A	5C
14	DQa	6N	32	OE	4F	50	DQc	1D	68	A	6C
15	DQa	6L	33	BWE	4M	51	DQc	2E	69	A1	4N
16	DQa	7K	34	GW	4H	52	DQc	2G	70	A0	4P
17	ZZ	7T	35	CLK	4K	53	DQc	1H			
18	DQb	6H	36	A	6B	54	NC	5R			

119 BGA BOUNDARY SCAN ORDER (512K X 18)

Bit #	Signal Name	Bump ID	Bit #	Signal Name	Bump ID	Bit #	Signal Name	Bump ID	Bit #	Signal Name	Bump ID
1	A	2R	14	DQa	7G	27	CLK	4K	40	DQb	2K
2	A	2T	15	DQa	6F	28	A	6B	41	DQb	1L
3	A	3T	16	DQa	7E	29	BWa	5L	42	DQb	2M
4	A	5T	17	DQa	6D	30	BWb	3G	43	DQb	1N
5	A	6R	18	A	6T	31	CE2	2B	44	DQb	2P
6	A	3B	19	A	6A	32	CE	4E	45	MODE	3R
7	A	5B	20	A	5A	33	A	3A	46	A	2C
8	DQa	7P	21	ADV	4G	34	A	2A	47	A	3C
9	DQa	6N	22	ADSP	4A	35	DQb	1D	48	A	5C
10	DQa	6L	23	ADSC	4B	36	DQb	2E	49	A	6C
11	DQa	7K	24	OE	4F	37	DQb	2G	50	A1	4N
12	ZZ	7T	25	BWE	4M	38	DQb	1H	51	A0	4P
13	DQa	6H	26	GW	4H	39	NC	5R			

165 PBGA BOUNDARY SCAN ORDER (x 36)

Bit #	Signal Name	Bump ID	Bit #	Signal Name	Bump ID	Bit #	Signal Name	Bump ID	Bit #	Signal Name	Bump ID
1	MODE	1R	21	DQb	11G	41	NC	1A	61	DQd	1J
2	NC	6N	22	DQb	11F	42	CE2	6A	62	DQd	1K
3	A	11P	23	DQb	11E	43	BW _a	5B	63	DQd	1L
4	A	8P	24	DQb	11D	44	BW _b	5A	64	DQd	1M
5	A	8R	25	DQb	10G	45	BW _c	4A	65	DQd	2J
6	A	9R	26	DQb	10F	46	BW _d	4B	66	DQd	2K
7	A	9P	27	DQb	10E	47	CE2	3B	67	DQd	2L
8	A	10P	28	DQb	10D	48	CE	3A	68	DQd	2M
9	A	10R	29	DQb	11C	49	A	2A	69	DQd	1N
10	A	11R	30	NC	11A	50	A	2B	70	A	3P
11	ZZ	11H	31	A	10A	51	NC	1B	71	A	3R
12	DQa	11N	32	A	10B	52	DQc	1C	72	A	4R
13	DQa	11M	33	ADV	9A	53	DQc	1D	73	A	4P
14	DQa	11L	34	ADSP	9B	54	DQc	1E	74	A1	6P
15	DQa	11K	35	ADSC	8A	55	DQc	1F	75	A0	6R
16	DQa	11J	36	OE	8B	56	DQc	1G			
17	DQa	10M	37	BWE	7A	57	DQc	2D			
18	DQa	10L	38	GW	7B	58	DQc	2E			
19	DQa	10K	39	CLK	6B	59	DQc	2F			
20	DQa	10J	40	NC	11B	60	DQc	2G			



165 PBGA BOUNDARY SCAN ORDER (x 18)

Bit #	Signal Name	Bump ID	Bit #	Signal Name	Bump ID	Bit #	Signal Name	Bump ID	Bit #	Signal Name	Bump ID
1	MODE	1R	21	DQa	11G	41	NC	1A	61	DQb	1J
2	NC	6N	22	DQa	11F	42	CE2	6A	62	DQb	1K
3	A	11P	23	DQa	11E	43	BW _a	5B	63	DQb	1L
4	A	8P	24	DQa	11D	44	NC	5A	64	DQb	1M
5	A	8R	25	DQa	11C	45	BW _b	4A	65	DQb	1N
6	A	9R	26	NC	10F	46	NC	4B	66	NC	2K
7	A	9P	27	NC	10E	47	CE2	3B	67	NC	2L
8	A	10P	28	NC	10D	48	CE	3A	68	NC	2M
9	A	10R	29	NC	10G	49	A	2A	69	NC	2J
10	A	11R	30	A	11A	50	A	2B	70	A	3P
11	ZZ	11H	31	A	10A	51	NC	1B	71	A	3R
12	NC	11N	32	A	10B	52	NC	1C	72	A	4R
13	NC	11M	33	ADV	9A	53	NC	1D	73	A	4P
14	NC	11L	34	ADSP	9B	54	NC	1E	74	A1	6P
15	NC	11K	35	ADSC	8A	55	NC	1F	75	A0	6R
16	NC	11J	36	OE	8B	56	NC	1G			
17	DQa	10M	37	BWE	7A	57	DQb	2D			
18	DQa	10L	38	GW	7B	58	DQb	2E			
19	DQa	10K	39	CLK	6B	59	DQb	2F			
20	DQa	10J	40	NC	11B	60	DQb	2G			

ORDERING INFORMATION ($V_{DD} = 3.3V/V_{DDQ} = 2.5V/3.3V$)**Commercial Range: 0°C to +70°C**

Configuration	Access Time	Order Part Number	Package ⁽¹⁾
256Kx36	6.5	IS61LF25636A-6.5TQ	100 TQFP, 3CE
		IS61LF25636A-6.5B2	119 PBGA
		IS61LF25636A-6.5B3	165 PBGA
256Kx36	7.5	IS61LF25636A-7.5TQ	100 TQFP, 3CE
		IS61LF25636A-7.5B2	119 PBGA
		IS61LF25636A-7.5B3	165 PBGA
512Kx18	6.5	IS61LF51218A-6.5TQ	100 TQFP, 3CE
		IS61LF51218A-6.5TQL	100 TQFP, 3CE, Lead-free
		IS61LF51218A-6.5B2	119 PBGA
		IS61LF51218A-6.5B3	165 PBGA
512Kx18	7.5	IS61LF51218A-7.5TQ	100 TQFP, 3CE
		IS61LF51218A-7.5B2	119 PBGA
		IS61LF51218A-7.5B3	165 PBGA

Industrial Range: -40°C to +85°C

Configuration	Access Time	Order Part Number	Package ⁽¹⁾
256Kx36	6.5	IS61LF25636A-6.5TQI	100 TQFP, 3CE
		IS61LF25636A-6.5B2I	119 PBGA
		IS61LF25636A-6.5B3I	165 PBGA
256Kx36	7.5	IS61LF25636A-7.5TQI	100 TQFP, 3CE
		IS61LF25636A-7.5TQLI	100 TQFP, 3CE, Lead-free
		IS61LF25636A-7.5B2I	119 PBGA
		IS61LF25636A-7.5B3I	165 PBGA
512Kx18	6.5	IS61LF51218A-6.5TQI	100 TQFP, 3CE
		IS61LF51218A-6.5B2I	119 PBGA
		IS61LF51218A-6.5B3I	165 PBGA
512Kx18	7.5	IS61LF51218A-7.5TQI	100 TQFP, 3CE
		IS61LF51218A-7.5TQLI	100 TQFP, 3CE, Lead-free
		IS61LF51218A-7.5B2I	119 PBGA
		IS61LF51218A-7.5B3I	165 PBGA

Note:

1. For 100 TQFP, 2CE option contact SRAM Marketing at sram@issi.com

Automotive Range: -40°C to +125°C

Configuration	Access Time	Order Part Number	Package ⁽¹⁾
256Kx36	7.5	IS64LF25636A-7.5TQLA3	100 TQFP, 3CE, Lead-free
		IS64LF25636A-7.5B3LA3	165 PBGA, Lead-free
512Kx18	7.5	IS64LF51218A-7.5TQLA3	100 TQFP, 3CE, Lead-free



ORDERING INFORMATION (V_{DD} = 2.5V /V_{DDQ} = 2.5V)

Commercial Range: 0°C to +70°C

Configuration	Access Time	Order Part Number	Package ⁽¹⁾
256Kx36	6.5	IS61VF25636A-6.5TQ	100 TQFP, 3CE
		IS61VF25636A-6.5B2	119 PBGA
		IS61VF25636A-6.5B3	165 PBGA
256Kx36	7.5	IS61VF25636A-7.5TQ	100 TQFP, 3CE
		IS61VF25636A-7.5B2	119 PBGA
		IS61VF25636A-7.5B3	165 PBGA
512Kx18	6.5	IS61VF51218A-6.5TQ	100 TQFP, 3CE
		IS61VF51218A-6.5B2	119 PBGA
		IS61VF51218A-6.5B3	165 PBGA
512Kx18	7.5	IS61VF51218A-7.5TQ	100 TQFP, 3CE
		IS61VF51218A-7.5B2	119 PBGA
		IS61VF51218A-7.5B3	165 PBGA

Industrial Range: -40°C to +85°C

Configuration	Access Time	Order Part Number	Package ⁽¹⁾
256Kx36	6.5	IS61VF25636A-6.5TQI	100 TQFP, 3CE
		IS61VF25636A-6.5B2I	119 PBGA
		IS61VF25636A-6.5B3I	165 PBGA
256Kx36	7.5	IS61VF25636A-7.5TQI	100 TQFP, 3CE
		IS61VF25636A-7.5B2I	119 PBGA
		IS61VF25636A-7.5B3I	165 PBGA
512Kx18	6.5	IS61VF51218A-6.5TQI	100 TQFP, 3CE
		IS61VF51218A-6.5B2I	119 PBGA
		IS61VF51218A-6.5B3I	165 PBGA
512Kx18	7.5	IS61VF51218A-7.5TQI	100 TQFP, 3CE
		IS61VF51218A-7.5B2I	119 PBGA
		IS61VF51218A-7.5B3I	165 PBGA

Note:

1. For 100 TQFP, 2CE option contact SRAM Marketing at sram@issi.com



SYMBOL	DIMENSION IN MM			DIMENSION IN INCH		
	MIN.	NOM.	MAX.	MIN.	NOM.	MAX.
A	1.40		1.60	0.055		0.063
A1	0.05		0.15	0.002		0.006
A2	1.35	1.40	1.45	0.053	0.055	0.057
b	0.22	0.30	0.38	0.009	0.012	0.015
D	21.90	22.00	22.10	0.862	0.866	0.870
D1	19.90	20.00	20.10	0.783	0.787	0.791
E	15.90	16.00	16.10	0.626	0.630	0.634
E1	13.90	14.00	14.10	0.547	0.551	0.555
e	0.65 BSC.			0.026 BSC.		
L	0.45	0.60	0.75	0.018	0.024	0.030
L1	0.25 BSC.			0.010 BSC.		
ZD	0.575 REF.			0.023 REF.		
ZE	0.825 REF.			0.032 REF.		
ϕ	0	3.5°	7°	0	3.5°	7°

NOTE :

1. CONTROLLING DIMENSION : MM
2. DIMENSION D1 AND E1 DO NOT INCLUDE MOLD PROTRUSION.
3. DIMENSION b DOES NOT INCLUDE DAMBAR PROTRUSION/INTRUSION.

	TITLE	REV.	DATE
	100L14x20x1.4mm LQFP (Footprint : 2.0 mm) Package Outline	F	09/01/2009

280-600-011 REV. A



	TITLE	119L 14x22mm PBGA Package Outline	REV. D	DATE 10/02/2008
--	-------	--------------------------------------	--------	-----------------



	TITLE	165L 13x15mm TF-BGA Package Outline	REV. B	DATE 08/28/2008
--	-------	-------------------------------------	--------	-----------------

Данный компонент на территории Российской Федерации

Вы можете приобрести в компании MosChip.

Для оперативного оформления запроса Вам необходимо перейти по данной ссылке:

<http://moschip.ru/get-element>

Вы можете разместить у нас заказ для любого Вашего проекта, будь то серийное производство или разработка единичного прибора.

В нашем ассортименте представлены ведущие мировые производители активных и пассивных электронных компонентов.

Нашей специализацией является поставка электронной компонентной базы двойного назначения, продукции таких производителей как XILINX, Intel (ex.ALTERA), Vicor, Microchip, Texas Instruments, Analog Devices, Mini-Circuits, Amphenol, Glenair.

Сотрудничество с глобальными дистрибьюторами электронных компонентов, предоставляет возможность заказывать и получать с международных складов практически любой перечень компонентов в оптимальные для Вас сроки.

На всех этапах разработки и производства наши партнеры могут получить квалифицированную поддержку опытных инженеров.

Система менеджмента качества компании отвечает требованиям в соответствии с ГОСТ Р ИСО 9001, ГОСТ РВ 0015-002 и ЭС РД 009

Офис по работе с юридическими лицами:

105318, г.Москва, ул.Щербаковская д.3, офис 1107, 1118, ДЦ «Щербаковский»

Телефон: +7 495 668-12-70 (многоканальный)

Факс: +7 495 668-12-70 (доб.304)

E-mail: info@moschip.ru

Skype отдела продаж:

moschip.ru

moschip.ru_4

moschip.ru_6

moschip.ru_9