

Description: 2.4-2.5GHz Monopole swivel stick antenna

Series: Stick Antenna

PART NUMBER: W1030



Features:

- Frequency 2400-2500MHz
- Gain 2.0 dBi
- VSWR 2:1
- Length 108mm Straight position
- Connector:
 - RP SMA Male as default
 - SMA Male available by request

Applications:

- 2.4GHz ISM band radios
- Bluetooth, BLE, Zigbee
- WLAN, WiFi 802.11x for 2.4GHz
- Indoor use

All dimensions are in mm / inches

Issue: 1948

In the effort to improve our products, we reserve the right to make changes judged to be necessary.

CONFIDENTIAL AND PROPRIETARY INFORMATION

This document contains confidential and proprietary information of Pulse Electronics, Inc. (Pulse) and is protected by copyright, trade secret and other state and federal laws. Its receipt or possession does not convey any rights to reproduce, disclose its contents, or to manufacture, use or sell anything it may describe. Reproduction, disclosure or use without specific written authorization of Pulse is strictly forbidden.

For more information:

Pulse Worldwide Headquarters
15255 Innovation Drive #100
San Diego, CA 92128
USA
Tel: 1-858-674-8100

Pulse/Larsen Antennas
18110 SE 34th St Bldg 2 Suite 250
Vancouver, WA 98683
USA
Tel: 1-360-944-7551

Europe Headquarters
Pulse GmbH & Do, KG
Zeppelinstrasse 15
Herrenberg, Germany
Tel: 49 7032 7806 0

Pulse (Suzhou) Wireless Products Co, Inc.
99 Huo Ju Road(#29 Bldg,4th Phase
Suzhou New District
Jiangsu Province, Suzhou 215009 PR China
Tel: 86 512 6807 9998



Description : 2.4-2.5GHz Monopole swivel stick antenna

Series: Stick Antenna

PART NUMBER: W1030

ELECTRICAL SPECIFICATIONS

Antenna Type	1/4 λ Swivel Type Dipole Antenna
Frequency	2.4-2.5 GHz
Nominal Impedance	50 Ω
VSWR	≤ 2.0
Radiation Pattern	Omni
Gain	2.0 dBi
Polarization	Vertical
Electrical Length	1/4 λ , dipole (monopole)

MECHANICAL SPECIFICATIONS

Overall Length	108 mm
Weight	6.3 g
Antenna Color	Black
Connector type	Reverse SMA (Male), default SMA (Male), by request

ENVIRONMENTAL SPECIFICATIONS

Operating Temperature	-40~+85° C
Storage Temperature	-40~+85° C
RoHS Compliant	Yes

Description : 2.4-2.5GHz Monopole swivel stick antenna

Series: Stick Antenna

PART NUMBER: W1030

MECHANICAL DRAWING

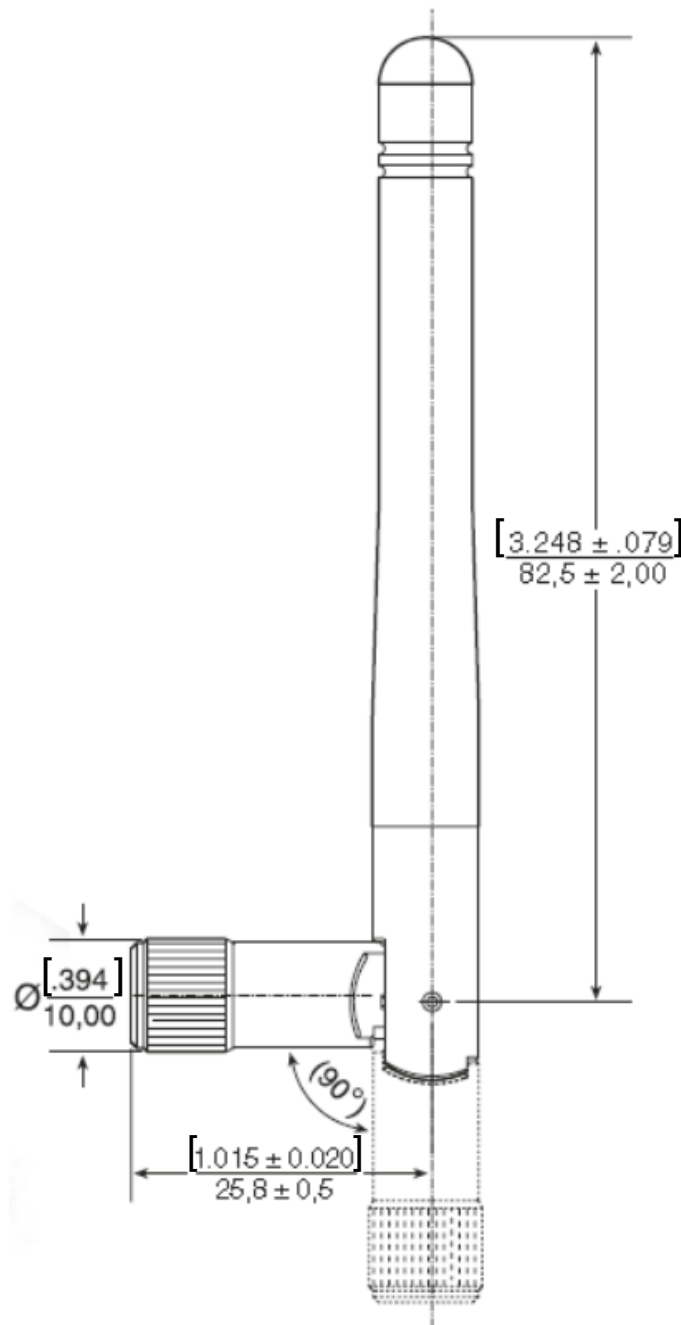

Issue: 1948

In the effort to improve our products, we reserve the right to make changes judged to be necessary.

CONFIDENTIAL AND PROPRIETARY INFORMATION

This document contains confidential and proprietary information of Pulse Electronics, Inc. (Pulse) and is protected by copyright, trade secret and other state and federal laws. Its receipt or possession does not convey any rights to reproduce, disclose its contents, or to manufacture, use or sell anything it may describe. Reproduction, disclosure or use without specific written authorization of Pulse is strictly forbidden.

Description : 2.4-2.5GHz Monopole swivel stick antenna

Series: Stick Antenna

PART NUMBER: W1030

CHARTS

Gain Performance: Horizontal Position

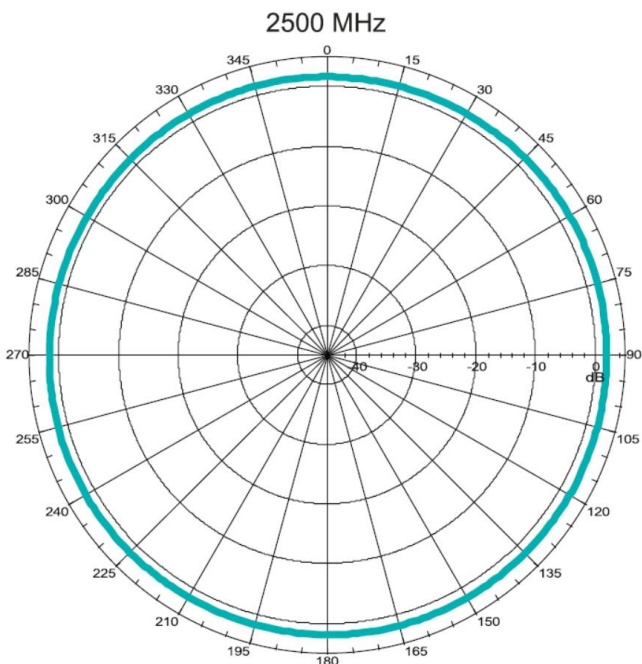
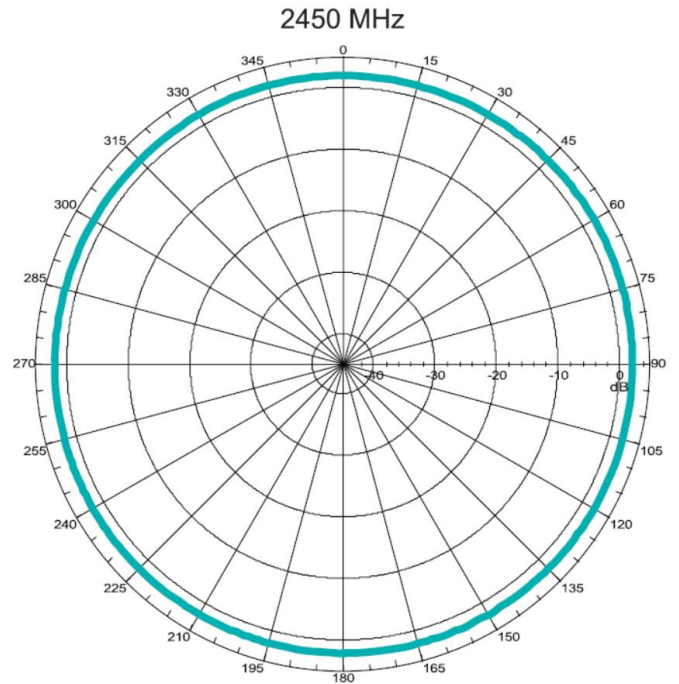
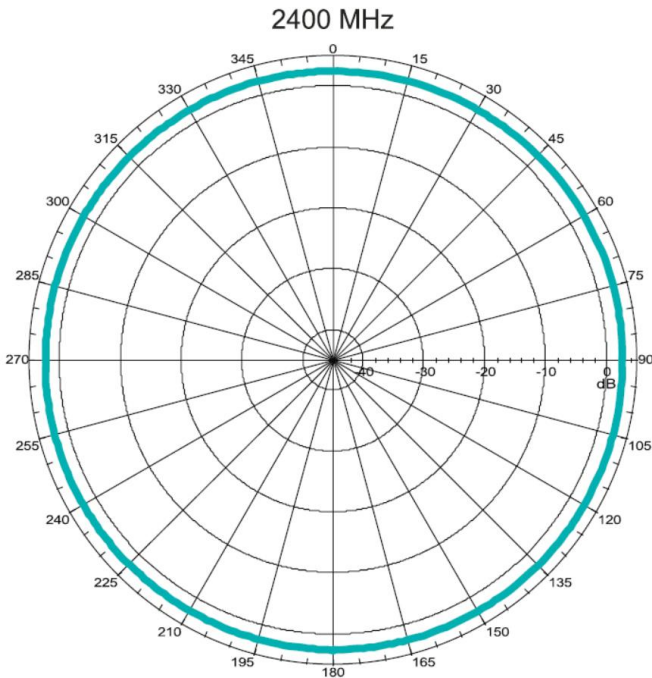

Issue: 1948

In the effort to improve our products, we reserve the right to make changes judged to be necessary.

CONFIDENTIAL AND PROPRIETARY INFORMATION

This document contains confidential and proprietary information of Pulse Electronics, Inc. (Pulse) and is protected by copyright, trade secret and other state and federal laws. Its receipt or possession does not convey any rights to reproduce, disclose its contents, or to manufacture, use or sell anything it may describe. Reproduction, disclosure or use without specific written authorization of Pulse is strictly forbidden.

Description : 2.4-2.5GHz Monopole swivel stick antenna

Series: Stick Antenna

PART NUMBER: W1030

CHARTS

Gain Performance: Vertical Position

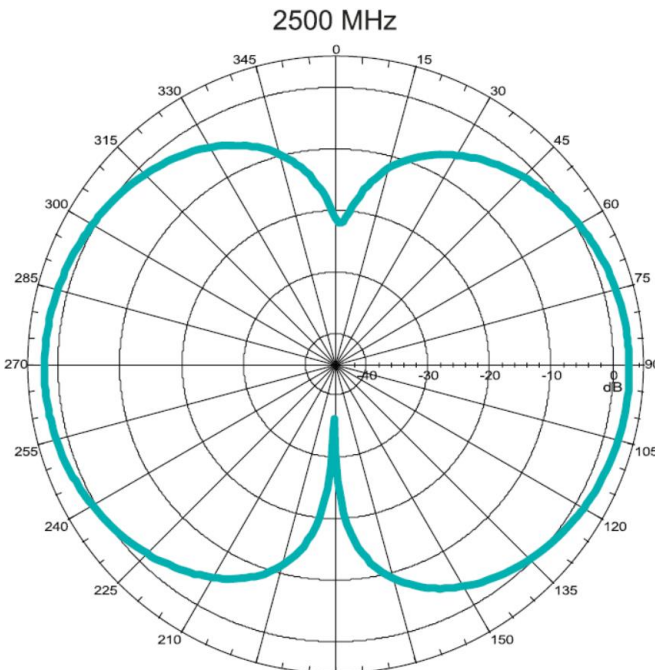
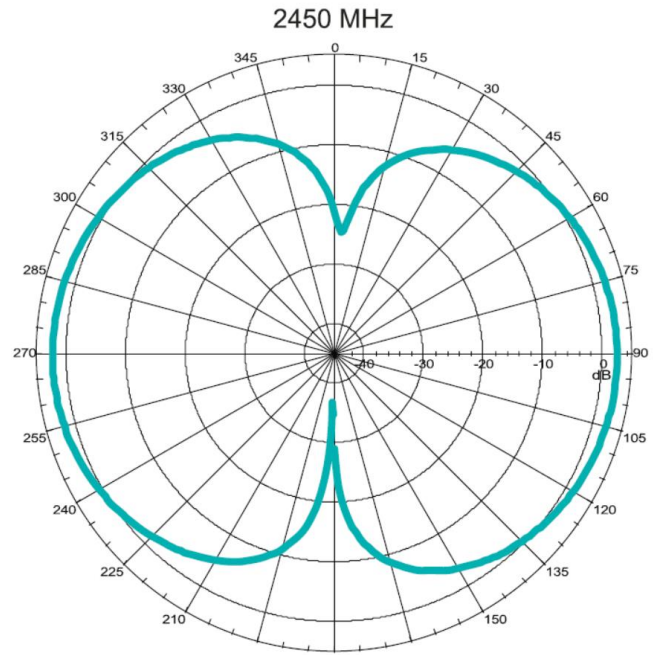
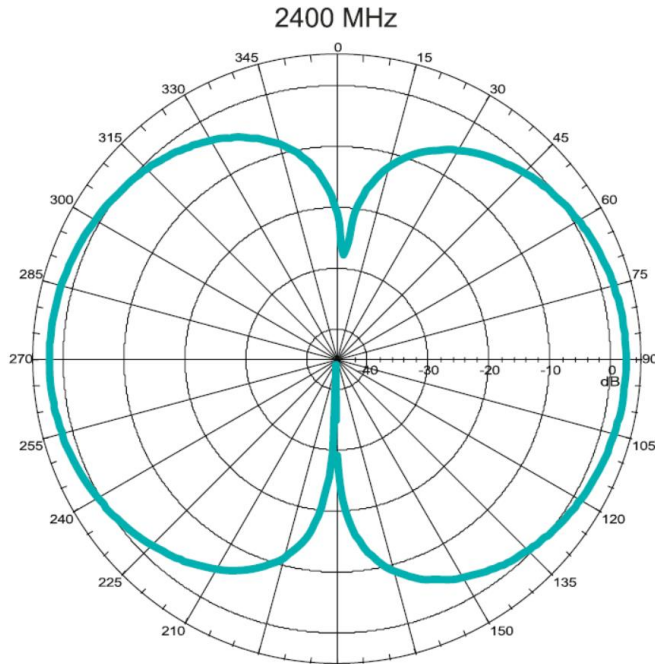

Issue: 1948

In the effort to improve our products, we reserve the right to make changes judged to be necessary.

CONFIDENTIAL AND PROPRIETARY INFORMATION

This document contains confidential and proprietary information of Pulse Electronics, Inc. (Pulse) and is protected by copyright, trade secret and other state and federal laws. Its receipt or possession does not convey any rights to reproduce, disclose its contents, or to manufacture, use or sell anything it may describe. Reproduction, disclosure or use without specific written authorization of Pulse is strictly forbidden.

Description : 2.4-2.5GHz Monopole swivel stick antenna

Series: Stick Antenna

PART NUMBER: W1030

PACKAGING

Pack 20pcs antenna in one PE bag, 30pcs PE bag (600pcs Antenna) in one carton.

Данный компонент на территории Российской Федерации

Вы можете приобрести в компании MosChip.

Для оперативного оформления запроса Вам необходимо перейти по данной ссылке:

<http://moschip.ru/get-element>

Вы можете разместить у нас заказ для любого Вашего проекта, будь то серийное производство или разработка единичного прибора.

В нашем ассортименте представлены ведущие мировые производители активных и пассивных электронных компонентов.

Нашей специализацией является поставка электронной компонентной базы двойного назначения, продукции таких производителей как XILINX, Intel (ex.ALTERA), Vicor, Microchip, Texas Instruments, Analog Devices, Mini-Circuits, Amphenol, Glenair.

Сотрудничество с глобальными дистрибьюторами электронных компонентов, предоставляет возможность заказывать и получать с международных складов практически любой перечень компонентов в оптимальные для Вас сроки.

На всех этапах разработки и производства наши партнеры могут получить квалифицированную поддержку опытных инженеров.

Система менеджмента качества компании отвечает требованиям в соответствии с ГОСТ Р ИСО 9001, ГОСТ РВ 0015-002 и ЭС РД 009

Офис по работе с юридическими лицами:

105318, г.Москва, ул.Щербаковская д.3, офис 1107, 1118, ДЦ «Щербаковский»

Телефон: +7 495 668-12-70 (многоканальный)

Факс: +7 495 668-12-70 (доб.304)

E-mail: info@moschip.ru

Skype отдела продаж:

moschip.ru

moschip.ru_4

moschip.ru_6

moschip.ru_9