

98 42 937 0201



Pushing Performance

# HARTING Han<sup>®</sup> GND



People | Power | Partnership

## Han® GND - Mateable Potential Equalization

The new Han® GND series now enables pluggable grounding systems

Han® GND (Han® Ground) is the innovative HARTING solution for potential equalization. The new connector series makes it possible to execute grounding systems in a pluggable design for the first time.

The use of connectors has been well-established in the electrical cabling of machines and systems for many years. The advantage is quick and error-free commissioning. Potential equalization lines are still being permanently connected, which is relatively time-consuming and can be subject to errors. HARTING's remedy: the Han® GND. The single-pole connector in the robust IP 65 plastic housing is designed for stranded wires from 10 - 35 mm<sup>2</sup> and is optionally available in crimp or axial screw termination. The latter has the advantage that the lines can be connected without a special tool. A simple screwdriver is all it takes to achieve a quick and easy reliable connection. Extra connector mating security can be provided by the use of additional locking elements that prevent unintentional opening.

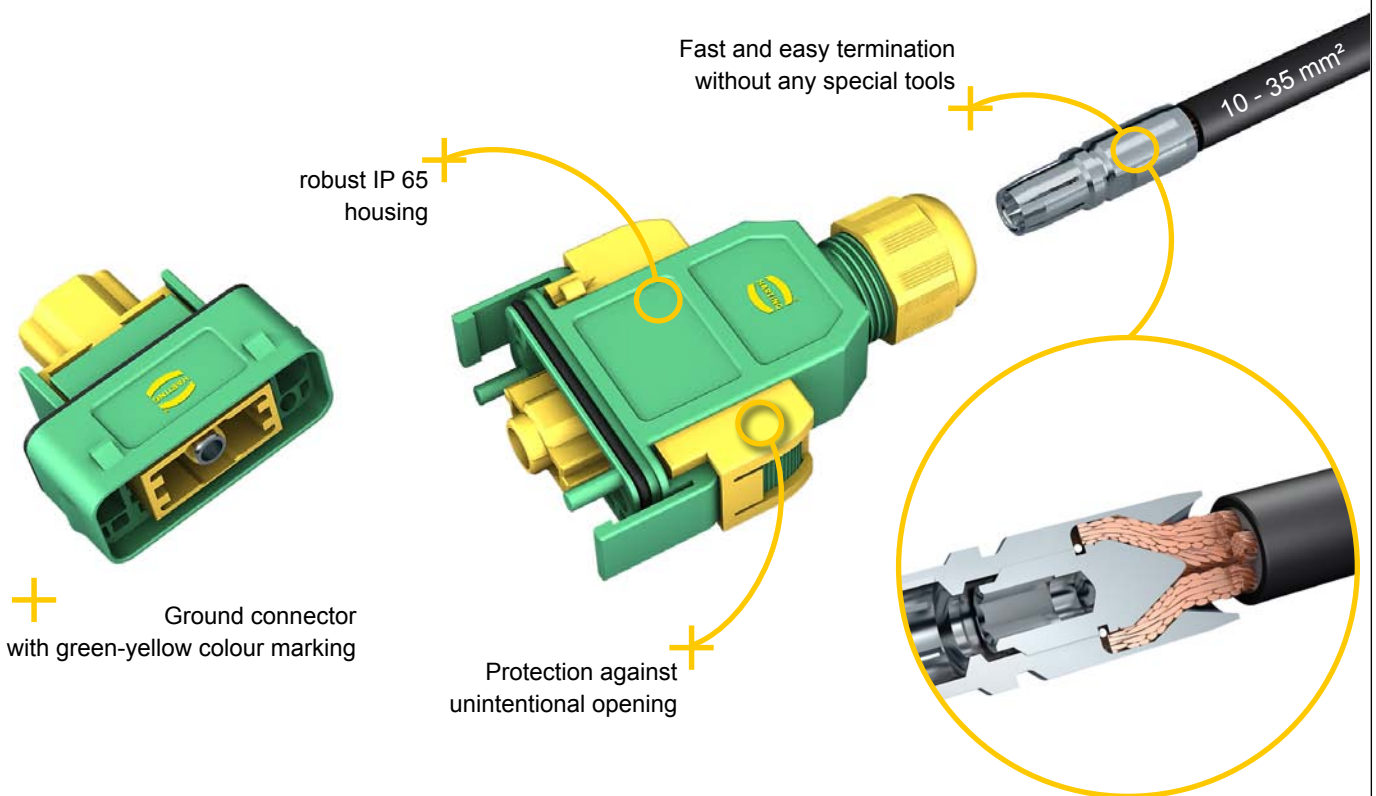

## Features

- New: First connector for potential equalization
- Slim, space saving design
- Low cost plastic hoods and housings
- Colours: green and yellow
- Separate axial screw contacts can be terminated without any special tools directly to the wire.

## Technical characteristics

Specifications	DIN EN 60 664-1 DIN EN 61 984
<b>Hoods/Housings</b>	
Material	polycarbonate
- hoods/housings	NBR
- seal	polyamide
- cable seal	
Limiting temperatures	-40 °C ... +85 °C
Flammability acc. to UL 94	V 0
Degree of protection according to DIN EN 60 529 for coupled connectors	IP 65
Mechanical working life	≥ 500 mating cycles
Cable diameter	7.5 - 14 mm
<b>Modules</b>	
Number of contacts	1
Material	polycarbonate
Limiting temperatures	-40 °C ... +125 °C
Flammability acc. to UL 94	V 0
Mechanical working life	≥ 500 mating cycles
<b>Crimp Contacts</b>	
Material	copper alloy
Surface	
- hard-silver plated	3 µm Ag
Contact resistance	≤ 0.3 mΩ
Crimp terminal	
- wire gauge <sup>1)</sup>	10 ... 35 mm <sup>2</sup>
<b>Axial Screw Contacts</b>	
Material	copper alloy
Surface	
- hard-silver plated	3 µm Ag
Contact resistance	≤ 0.3 mΩ
Screw terminal	
- wire gauge <sup>1)</sup>	10 ... 35 mm <sup>2</sup>
- AWG	6 ... 2
- hexagonal driver	SW 4
- tightening torque	

mm <sup>2</sup>	10	16	25	35
Nm	6	6	7	8

1) geometric wire gauge

Number of contacts

# 1

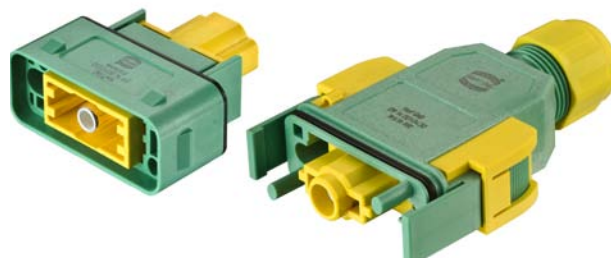

Mateable Potential Equalization

Identification      Part-Number      Drawings      Dimensions in mm

Hood  
top entry



09 14 001 0430

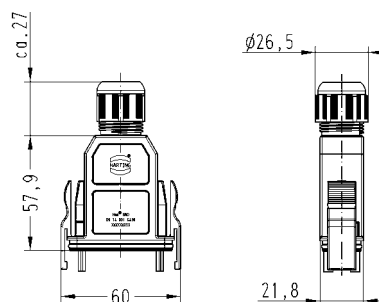

Unlocking Protection



09 14 000 9938

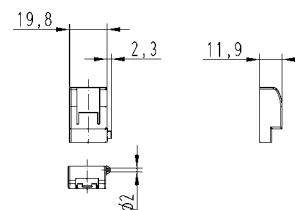

Housing



09 14 001 0330

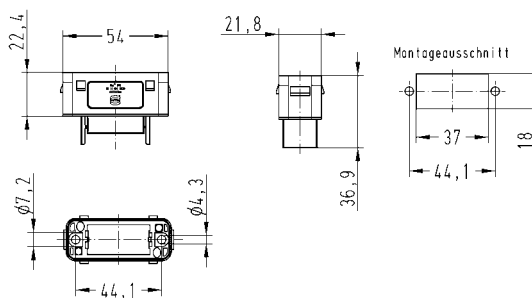

Hoods, cable to cable



09 14 001 0730

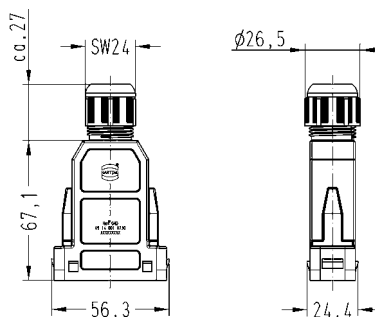





Gender changer / coupler  
male / male

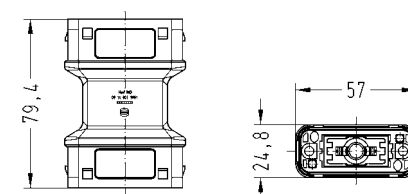

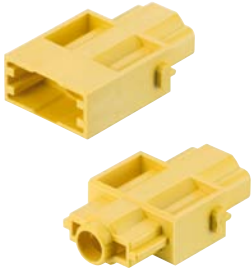
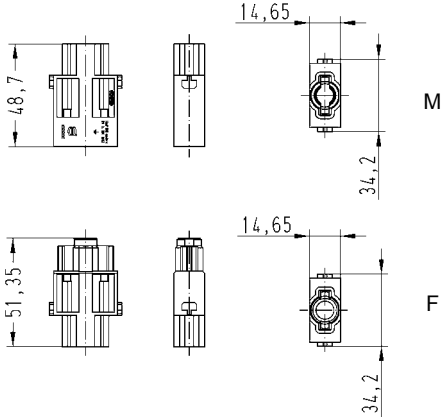

09 14 001 9901

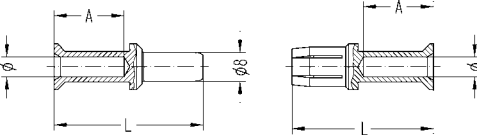

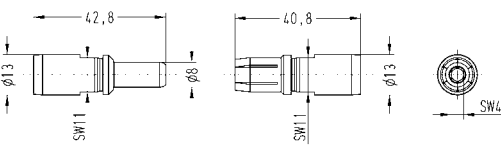
Identification	Part-Number		Drawings	Dimensions in mm
	Male module (M)	Female module (F)		
<b>Modules</b> order contacts separately 	09 14 001 3032	09 14 001 3132		M F

Identification	Wire gauge (mm <sup>2</sup> )	Part number		Drawing	Dimensions in mm															
		Male contact	Female contact																	
<b>Crimp contacts*</b> 	10 16 25 35	09 11 000 6114 09 11 000 6116 09 11 000 6125 09 11 000 6135	09 11 000 6214 09 11 000 6216 09 11 000 6225 09 11 000 6235	 <table border="1" data-bbox="989 1198 1460 1366"> <thead> <tr> <th>Wire gauge</th> <th>Ø</th> <th>Stripping length (A)</th> </tr> </thead> <tbody> <tr> <td>10 mm<sup>2</sup></td> <td>4.3</td> <td>19 mm</td> </tr> <tr> <td>16 mm<sup>2</sup></td> <td>5.5</td> <td>19 mm</td> </tr> <tr> <td>25 mm<sup>2</sup></td> <td>7.0</td> <td>19 mm</td> </tr> <tr> <td>35 mm<sup>2</sup></td> <td>8.2</td> <td>16 mm</td> </tr> </tbody> </table> <p>for stranded wire acc. to IEC 60 228 Class 5</p>	Wire gauge	Ø	Stripping length (A)	10 mm <sup>2</sup>	4.3	19 mm	16 mm <sup>2</sup>	5.5	19 mm	25 mm <sup>2</sup>	7.0	19 mm	35 mm <sup>2</sup>	8.2	16 mm	
Wire gauge	Ø	Stripping length (A)																		
10 mm <sup>2</sup>	4.3	19 mm																		
16 mm <sup>2</sup>	5.5	19 mm																		
25 mm <sup>2</sup>	7.0	19 mm																		
35 mm <sup>2</sup>	8.2	16 mm																		
<b>Axial screw contacts</b> 	10-25 16-35	09 11 000 6112 09 11 000 6113	09 11 000 6212 09 11 000 6213	 <p>Stripping length 13 mm</p>																

Identification	Part number	Drawing	Dimensions in mm
<b>Hex key SW 4</b> for axial setscrew with grip 	09 99 000 0363		
Bit 3/8" 	09 99 000 0370		

\* Crimp zone acc. to DIN EN 46 235  
 For further information see chapter 99 (Tools) in the main catalogue „Industrial Connectors Han®“

## Assembly and construction

### Assembly

Please use fine stranded wire (Class 5) which is recommend for the axial screw termination.

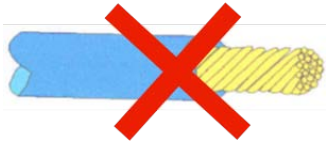

Do not twist the stripped wire!

1.

Please strip the wire. All suitable wire gauges have to be stripped with a length of 13 mm (acc. to Class 5 wire). Insert stripped wire into the terminal and push fully inside. Pay attention that all fine stranded wires are inserted in the contact.

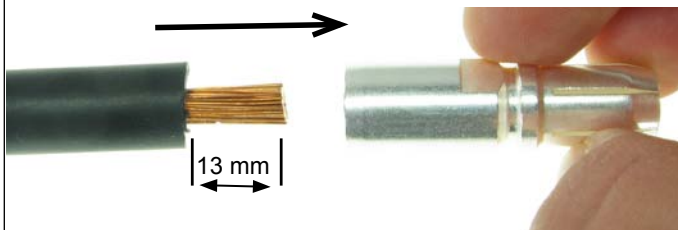

stripping length

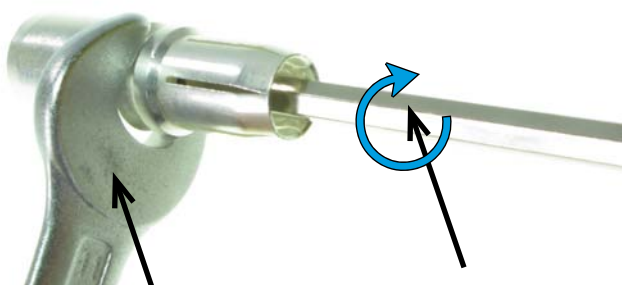
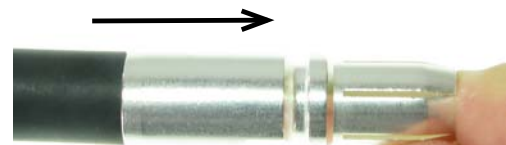

turn clockwise

Secure axial screw

2.

Please insert suitable torque key (SW 4) into the contact from mating side and turn the axial screw clockwise. For that purpose secure the axial screw with a spanner (SW 11). Tighten the screw to the specified torque value.

## Assembly and construction



3. Insert the installed cable through the cable gland into the Han® GND housing! Push the axial screw contact into the module until you hear an audible click, which is the indicator that the contact snaps into position.



4. Push the module back into the housing and turn the cable gland clockwise.

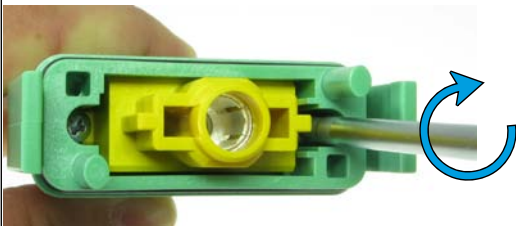

5. Mount the module in the housing with the enclosed screws.

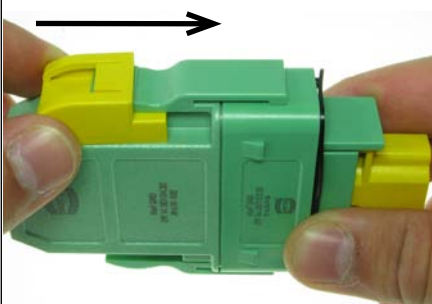

### Protection against unintentional opening

1. Push the unlocking protection over the opening latches to prevent an unintentional opening (the connector can only be unmounted with a separate tool).

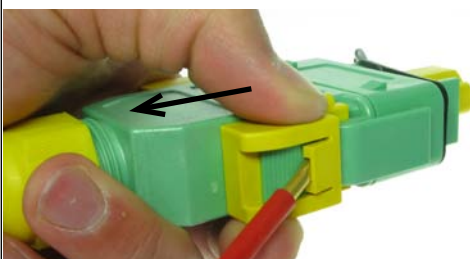

2. The removal of the unlocking protection can be done with a screwdriver for slotted screws (e.g. size 0.8 x 4.0). Insert the screwdriver in the unlocking protection slot and release the plastic latch until you are able to remove the unlocking protection with your fingers.



**Pushing Performance**

[www.HARTING.com](http://www.HARTING.com)



## Данный компонент на территории Российской Федерации

### Вы можете приобрести в компании MosChip.

Для оперативного оформления запроса Вам необходимо перейти по данной ссылке:

<http://moschip.ru/get-element>

Вы можете разместить у нас заказ для любого Вашего проекта, будь то серийное производство или разработка единичного прибора.

В нашем ассортименте представлены ведущие мировые производители активных и пассивных электронных компонентов.

Нашей специализацией является поставка электронной компонентной базы двойного назначения, продукции таких производителей как XILINX, Intel (ex.ALTERA), Vicor, Microchip, Texas Instruments, Analog Devices, Mini-Circuits, Amphenol, Glenair.

Сотрудничество с глобальными дистрибьюторами электронных компонентов, предоставляет возможность заказывать и получать с международных складов практически любой перечень компонентов в оптимальные для Вас сроки.

На всех этапах разработки и производства наши партнеры могут получить квалифицированную поддержку опытных инженеров.

Система менеджмента качества компании отвечает требованиям в соответствии с ГОСТ Р ИСО 9001, ГОСТ РВ 0015-002 и ЭС РД 009

### Офис по работе с юридическими лицами:

105318, г.Москва, ул.Щербаковская д.3, офис 1107, 1118, ДЦ «Щербаковский»

Телефон: +7 495 668-12-70 (многоканальный)

Факс: +7 495 668-12-70 (доб.304)

E-mail: [info@moschip.ru](mailto:info@moschip.ru)

Skype отдела продаж:

moschip.ru

moschip.ru\_4

moschip.ru\_6

moschip.ru\_9