

E3T

Photoelectric Sensor with Built-in Amplifier Contributes to Equipment Downsizing

- Ultracompact and Thin Photoelectric Sensor with Built-in Amplifier
- Easy optical axis adjustment with emitter fluctuation of $\pm 2\%$ max. for Through-beam Models.
- Product lineup includes Coaxial Retro-reflective Models that support positioning applications.
- Product lineup includes BGS* Reflective Models unaffected by background (E3T-FL1□/-FL2□).
- Product lineup of models with a variety of connection specifications. (e.g., robot cable and Smartclick pre-wired connectors)

* BGS (Background Suppression) technology prevents detecting background objects.



 Be sure to read *Safety Precautions* on page 14.

Features

E3T-SR4□ **NEW** : Retro-reflective Sensor with Enhanced Compactness and High Performance

- Perform detection from a small hole.

With a coaxial optical system, the lens diameter is only 2 mm.

Sufficient incident light is obtained even through a small hole.

The Coaxial Retro-reflective Sensor can be used for reliable application with positioning.



- Improved Stability of Short-distance Detection

A detection distance as short as 10 mm can be used with a Tape Reflector.

Detection is stable through a hole whether the distance is 10 mm or 100 mm (except in combination with the E39-R4).



E3T-FL1□/-FL2□: The Slimmest BGS (Background Suppression) Reflective Photoelectric Sensors in the World

Ultra slim at 3.5 mm and black/white error of only 15%.

For example, the E3T-FL1□ can stably detect a black object at 12 mm without being affected by a white background at 20 mm.

OMRON provides BGS performance sharper than the previous Convergent-reflective Sensors.



Dramatic Improvement in Black/White Error



Ordering Information

Sensors (Refer to Dimensions on page 15.)

 Red light

Sensing method	Appearance		Connection method	Sensing distance	Operation mode	Model	
						NPN output	PNP output
Through-beam (Emitter + Receiver) *1	 Side-view	 Flat	Pre-wired (2 m)	 1 m (Sensitivity Adjustment Unit can be used.)	Light-ON	E3T-ST11 2M *2 Emitter E3T-ST11-L 2M Receiver E3T-ST11-D 2M	E3T-ST13 2M *2 Emitter E3T-ST13-L 2M Receiver E3T-ST13-D 2M
				Dark-ON	E3T-ST12 2M *2 Emitter E3T-ST12-L 2M Receiver E3T-ST12-D 2M	E3T-ST14 2M *2 Emitter E3T-ST14-L 2M Receiver E3T-ST14-D 2M	
				Light-ON	E3T-ST21 2M *2 Emitter E3T-ST21-L 2M Receiver E3T-ST21-D 2M	E3T-ST23 2M *2 Emitter E3T-ST23-L 2M Receiver E3T-ST23-D 2M	
				Dark-ON	E3T-ST22 2M *2 Emitter E3T-ST22-L 2M Receiver E3T-ST22-D 2M	E3T-ST24 2M *2 Emitter E3T-ST24-L 2M Receiver E3T-ST24-D 2M	
	 Side-view	 Flat		 500 mm	Light-ON	E3T-FT11 2M Emitter E3T-FT11-L 2M Receiver E3T-FT11-D 2M	E3T-FT13 2M Emitter E3T-FT13-L 2M Receiver E3T-FT13-D 2M
				Dark-ON	E3T-FT12 2M Emitter E3T-FT12-L 2M Receiver E3T-FT12-D 2M	E3T-FT14 2M Emitter E3T-FT14-L 2M Receiver E3T-FT14-D 2M	
				Light-ON	E3T-FT21 2M Emitter E3T-FT21-L 2M Receiver E3T-FT21-D 2M	E3T-FT23 2M Emitter E3T-FT23-L 2M Receiver E3T-FT23-D 2M	
				Dark-ON	E3T-FT22 2M Emitter E3T-FT22-L 2M Receiver E3T-FT22-D 2M	E3T-FT24 2M Emitter E3T-FT24-L 2M Receiver E3T-FT24-D 2M	
Retro-reflective *3	 Side-view	 Flat	Using the E39-R4 Reflector provided 200 mm [30 mm] *4  Using the E39-R37-CA 100 mm [10 mm] *4 	Light-ON	E3T-SR41 2M *5	E3T-SR43 2M *5	
				Dark-ON	E3T-SR42 2M *5	E3T-SR44 2M *5	
Diffuse-reflective	 Side-view	 Flat	 5 to 30 mm	Light-ON	E3T-FD11 2M *2	E3T-FD13 2M *2	
				Dark-ON	E3T-FD12 2M *2	E3T-FD14 2M *2	
Convergent-reflective	 Side-view	 Flat	 5 to 15 mm	Light-ON	E3T-SL11 2M *2	E3T-SL13 2M *2	
				Dark-ON	E3T-SL12 2M *2	E3T-SL14 2M *2	
				Light-ON	E3T-SL21 2M *2	E3T-SL23 2M *2	
				Dark-ON	E3T-SL22 2M *2	E3T-SL24 2M *2	
BGS reflective	 Side-view	 Flat	 1 to 15 mm	Light-ON	E3T-FL11 2M	E3T-FL13 2M	
				Dark-ON	E3T-FL12 2M	E3T-FL14 2M	
				Light-ON	E3T-FL21 2M	E3T-FL23 2M	
				Dark-ON	E3T-FL22 2M	E3T-FL24 2M	

*1. Through-beam Sensors are normally sold in sets that include both the Emitter and Receiver.
 Orders for individual Emitters and Receivers are accepted. (Modifications are required for some models. Ask your OMRON representative for details.)
 *2. M3 mounting models are also available. These models have the M-suffix. Example: E3T-ST11M 2M
 Contact your OMRON representative for detail.
 *3. Ask your OMRON representative about the previous Retro-reflective Sensors: E3T-SR2□ and E3T-SR3□.
 *4. Values in parentheses indicate the minimum required distance between the Sensor and Reflector.
 *5. Models are available either with or without the E39-R37-CA Reflector included.
 Model with E39-R37-CA Reflector: E3T-SR4□-S
 Model without Reflector: E3T-SR4□-C

Variety of Connection Specifications

The models with the connection specifications marked with a black circle in the table are available. The model number indication is a combination of the basic model and the connection specification.

Example: E3T-ST11-M1TJ 0.3M

Basic model number Connection specification

NPN Output

Model			Model number example	E3T-ST11-M1TJ 0.3M	E3T-ST11 5M	E3T-ST11R 2M	E3T-ST11-ECON 0.3M	E3T-ST11-ECON 2M
Sensing method	Sensing distance	Operation mode	Connection specification	M12 pre-wired Smartclick Connector (cable length: 0.3 m)	Pre-wired (cable length: 5 m)	Pre-wired robot (cable length: 2 m)	e-CON pre-wired connector (cable length: 0.3 m)	e-CON pre-wired connector (cable length: 2 m)
			Basic model number	-M1TJ 0.3M	5M	R 2M	-ECON 0.3M	-ECON 2M
Through-beam (side-view)	1 m	Light-ON	E3T-ST11	●	●	●	●	●
		Dark-ON	E3T-ST12	●	●	●	●	●
	300 mm	Light-ON	E3T-ST21	●	●	---	●	●
		Dark-ON	E3T-ST22	●	●	---	●	●
Through-beam (flat)	500 mm	Light-ON	E3T-FT11	●	●	●	●	●
		Dark-ON	E3T-FT12	●	●	●	●	●
	300 mm	Light-ON	E3T-FT21	●	---	---	●	●
		Dark-ON	E3T-FT22	●	---	---	●	●
Retro-reflective	200 mm (100 mm)	Light-ON	E3T-SR41	●	●	●	●	●
		Dark-ON	E3T-SR42	●	●	●	●	●
Diffuse-reflective	5 to 30 mm	Light-ON	E3T-FD11	●	●	●	●	●
		Dark-ON	E3T-FD12	●	●	●	●	●
Convergent-reflective	5 to 15 mm	Light-ON	E3T-SL11	●	●	●	●	●
		Dark-ON	E3T-SL12	●	●	●	●	●
	5 to 30 mm	Light-ON	E3T-SL21	●	●	●	●	●
		Dark-ON	E3T-SL22	●	●	●	●	●
BGS reflective	1 to 15 mm	Light-ON	E3T-FL11	●	---	●	---	---
		Dark-ON	E3T-FL12	●	---	●	---	---
	1 to 30 mm	Light-ON	E3T-FL21	●	---	●	●	---
		Dark-ON	E3T-FL22	●	---	●	---	---

* The sensing distance depends on the Reflector that is used. The sensing distance is 200 mm if an E39-R4 is used and 100 mm if an E39-R37-CA is used.

PNP Output

Model			Model number example	E3T-ST13-M1TJ 0.3M	E3T-ST13 5M	E3T-ST13R 2M
Sensing method	Sensing distance	Operation mode	Connection specification	M12 pre-wired Smartclick Connector (cable length: 0.3 m)	Pre-wired (cable length: 5 m)	Pre-wired robot (cable length: 2 m)
			Basic model number	-M1TJ 0.3M	5M	R 2M
Through-beam (side-view)	1 m	Light-ON	E3T-ST13	●	●	●
		Dark-ON	E3T-ST14	●	●	●
	300 mm	Light-ON	E3T-ST23	●	---	---
		Dark-ON	E3T-ST24	●	---	---
Through-beam (flat)	500 mm	Light-ON	E3T-FT13	●	●	●
		Dark-ON	E3T-FT14	●	●	●
	300 mm	Light-ON	E3T-FT23	●	---	---
		Dark-ON	E3T-FT24	●	●	---

Model			Model number example	E3T-ST13-M1TJ 0.3M	E3T-ST13 5M	E3T-ST13R 2M
Sensing method	Sensing distance	Operation mode	Connection specification	M12 pre-wired Smartclick Connector (cable length: 0.3 m)	Pre-wired (cable length: 5 m)	Pre-wired robot (cable length: 2 m)
			Basic model number	-M1TJ 0.3M	5M	R 2M
Retro-reflective	200 mm (100 mm)	Light-ON	E3T-SR43	●	●	●
		Dark-ON	E3T-SR44	●	●	●
Diffuse-reflective	5 to 30 mm	Light-ON	E3T-FD13	●	●	●
		Dark-ON	E3T-FD14	●	●	●
Convergent-reflective	5 to 15 mm	Light-ON	E3T-SL13	●	●	●
		Dark-ON	E3T-SL14	●	●	●
	5 to 30 mm	Light-ON	E3T-SL23	●	●	●
		Dark-ON	E3T-SL24	●	●	●
BGS reflective	1 to 15 mm	Light-ON	E3T-FL13	●	---	●
		Dark-ON	E3T-FL14	●	---	●
	1 to 30 mm	Light-ON	E3T-FL23	●	---	●
		Dark-ON	E3T-FL24	●	---	●

* The sensing distance depends on the Reflector that is used. The sensing distance is 200 mm if an E39-R4 is used and 100 mm if an E39-R37-CA is used.

Accessories (Order Separately)

Slits (A Slit is not provided with the Sensor for through-beam. Order a Slit separately if required.) (Refer to *Dimensions* on page 18.)

Slit width	Sensing distance (typical) (Sensor model)	Minimum detectable object (typical)	Model	Quantity	Remarks
0.5-mm dia.	100 mm (E3T-ST1□)	0.5-mm dia.	E39-S63	One each for Emitter and Receiver; common with Slit widths of 1 dia. and 0.5 dia. (total of 2)	Plug-in type round slits Can be used with E3T-ST□□ Through-beam Models.
	30 mm (E3T-ST2□)				
1-mm dia.	300 mm (E3T-ST1□)	1-mm dia.			
	100 mm (E3T-ST2□)				
0.5-mm dia.	50 mm (E3T-FT1□)	0.5-mm dia.	E39-S64		Plug-in type round slits Can be used with E3T-FT□□ Through-beam Models.
	30 mm (E3T-FT2□)				
1-mm dia.	100 mm (E3T-FT1□)	1-mm dia.			
	50 mm (E3T-FT2□)				

Reflectors

(Requirement for retro-reflective: A Retroreflector is provided depending on the model number. Check the model number in remarks column.) (For Compact Reflectors, refer to *Dimensions* on page 17. For Tape Reflectors, refer to E39-L/F39-L/E39-S/E39-R.)

Name	Recommended Sensor	Sensing distance	Minimum detectable object	Model	Quantity	Remarks
Small Reflectors	E3T-SR4□	200 mm (30 mm) *1	2-mm dia.	E39-R4	1	Provided with the E3T-SR4□
	E3T-SR4□-S	100 mm (10 mm) *1		E39-R37-CA *2		Provided with the E3T-SR4□-S
Tape Reflectors	E3T-SR4□-C	100 mm (10 mm) *1		E39-RS1-CA *2		Use Tape Reflectors in combination with the E3T-SR4□-C, which does not come with a Reflector.
				E39-RS2-CA *2		
				E39-RS3-CA *2		

*1. Values in parentheses indicate the minimum required distance between the Sensor and Reflector.
 *2. The E3T-SR4□ cannot be used with the E39-R37 or E39-RS1/2/3 (without CA) Tape Reflectors.
 The E39-□-CA Reflector is for use only with the E3T-SR4□. It cannot be used with other Sensors.

Sensitivity Adjustment Unit

(A Unit is not provided with the Sensor (for the E3T-ST1□). Order a Unit separately if required.) (Refer to *Dimensions* on page 18.)

Appearance	Sensing distance (typical)	Model	Quantity	Remarks
	300 to 800 mm	E39-E10	1	Can be used with the E3T-ST1□ Through-beam Models.

Mounting Brackets

(A Mounting Bracket is not provided with the Sensor. Order a Mounting Bracket separately if required.) (Refer to *Dimensions* on page 18.)

Appearance	Model	Quantity	Remarks
	E39-L116	1	Can be used with the E3T-S□□□ Side-view Models. (A securing nut plate is provided with the Mounting Bracket.)
	E39-L117		
	E39-L118		
	E39-L119		Can be used with the E3T-F□□□ Flat Models.
	E39-L120		

Note: When using Through-beam models, order one bracket for the Receiver and one for the Emitter.

Set of Mounting Screws A Set is provided with the Sensor.

Applicable sensors	Model	Description	Material	Quantity	Remarks
Side-view models E3T-S□□□	E39-L164	Phillips screws (M2 × 14) Hexagonal nuts (M2) Spring washers (M2) Flat washers (M2)	Iron, zinc plating Iron, zinc plating Iron, nickel plating Iron, zinc plating	2 for each	Provided with the side-view models E3T-S□□□.
Flat models E3T-F□□□	E39-L165	Phillips screws (M2 × 8) Hexagonal nuts (M2) Spring washers (M2) Flat washers (M2)	Iron, zinc plating Iron, zinc plating Iron, nickel plating Iron, zinc plating		Provided with the flat models E3T-F□□□.

Note: If a Through-beam Model is used, order two sets of Mounting Screws, one for the Emitter and one for the Receiver.
 Used for mounting sensors. Order the set separately if it becomes lost or damaged.
 These screws are not used for mounting brackets to the equipment.

Sensor I/O Connectors

(Models with Pre-wired Connectors: A Connector is not provided with the Sensor. Be sure to order a Connector separately.)
 (For M12, refer to XS5. For e-CON, contact your OMRON representative.)

Size	Cable	Appearance	Cable type		Model
M12 (For-M1TJ models)	Standard	Straight 	2 m	4-wire	XS5F-D421-D80-A
			5 m		XS5F-D421-G80-A
e-CON	Standard cable	Connector on one end 	2 m	4-wire	E39-ECON2M
			5 m		E39-ECON5M
		Connector on both ends 	0.5 to 1 m		Replace □ with the cable length in 0.1-m increments.
			1.1 to 1.5 m		
1.6 to 2 m					

Note: When using Through-beam models, order one connector for the Receiver and one for the Emitter.

Ratings and Specifications

Sensing method	Through-beam				Retro-reflective (without M.S.R. function)	
	Side-view		Flat		Side-view	
	NPN	PNP	NPN	PNP	NPN	PNP
	E3T-ST11 E3T-ST12 E3T-ST21 E3T-ST22	E3T-ST13 E3T-ST14 E3T-ST23 E3T-ST24	E3T-FT11 E3T-FT12 E3T-FT21 E3T-FT22	E3T-FT13 E3T-FT14 E3T-FT23 E3T-FT24	E3T-SR41 E3T-SR42	E3T-SR43 E3T-SR44
Sensing distance	E3T-ST1□ E3T-ST2□	1 m 300 mm	E3T-FT1□ E3T-FT2□	500 mm 300 mm	E3T-SR4□ 200 mm (30 mm) (Using the E39-R4) 100 mm (10 mm) (Using the E39-R37-CA)	
Standard sensing object	Opaque, 2-mm dia. min.		Opaque, 1.3-mm dia. min.		Opaque, 27-mm dia. min.	
Minimum detectable object (typical)	2-mm dia opaque object		1.3-mm dia opaque object		2-mm dia. (sensing distance of 100 mm)	
Hysteresis (white paper)	---					
Black/white error	---					
Directional angle	Emitter: 2° to 20°, Receiver: 2° to 70°		Emitter: 3° to 25°, Receiver: 3° min.		2° to 20°	
Light source (wavelength)	Red LED ("Pin-point" LED) λ = 650 nm					
Power supply voltage	12 to 24 VDC ±10%, ripple (p-p) 10% max.					
Current consumption	30 mA max. (Emitter 10 mA max., Receiver 20 mA max.)				20 mA max.	
Control output	Load power supply voltage: 26.4 VDC max. Load current: 50 mA max. (residual voltage: 2 V max. for load current of 10 to 50 mA, 1 V max. for load current of less than 10 mA) Open-collector output Light ON: E3T-□□□1 and E3T-□□□3 Dark ON: E3T-□□□2 and E3T-□□□4					
Protection circuits	Power supply and control output reverse polarity protection Output short-circuit protection				Power supply and control output reverse polarity protection Output short-circuit protection, Mutual interference prevention	
Response time	Operate or reset: 1 ms max.					
Ambient illumination	Incandescent lamp: 5,000 lx max.,		Sunlight: 10,000 lx max.			
Ambient temperature range	Operating: -25 to 55°C		Storage: -40 to 70°C (with no icing or condensation)			
Ambient humidity range	Operating: 35% to 85%		Storage: 35% to 95% (with no condensation)			
Insulation resistance	20 MΩ min. at 500 VDC					
Dielectric strength	1,000 VAC, 50/60 Hz for 1 min					
Vibration resistance	Destruction: 10 to 2,000 Hz, 1.5-mm double amplitude or 300 m/s ² for 0.5 hrs each in X, Y, and Z directions					
Shock resistance	Destruction: 1,000 m/s ² 3 times each in X, Y, and Z directions					
Degree of protection	IP67 (IEC60529)					
Connection method	Pre-wired (standard length: 2 m)					
Weight	Approx. 40 g				Approx. 20 g	
Materials	Case	PBT (polybutylene terephthalate)				
	Display window	Denatured polyarylate				
	Lens	Denatured polyarylate				Methacrylic resin
Accessories	Instruction manual, Installation Phillips screws (Side-view Models: M2 × 14, Flat Models: M2 × 8), Nuts, Spring washers, Flat washers, E39-R4 (E3T-SR4□ only), E39-R37-CA (E3T-SR4□-S only)					

* Values in parentheses indicate the minimum required distance between the Sensor and Reflector.

Sensing method	Diffuse-reflective		Convergent-reflective				BGS reflective			
	Flat		Side-view				Flat			
	NPN	PNP	NPN	PNP	NPN	PNP	NPN	PNP	NPN	PNP
	E3T-FD11 E3T-FD12	E3T-FD13 E3T-FD14	E3T-SL11 E3T-SL12	E3T-SL13 E3T-SL14	E3T-SL21 E3T-SL22	E3T-SL23 E3T-SL24	E3T-FL11 E3T-FL12	E3T-FL13 E3T-FL14	E3T-FL21 E3T-FL22	E3T-FL23 E3T-FL24
Sensing distance	5 to 30 mm (50 × 50 mm white paper)		5 to 15 mm (50 × 50 mm white paper)		5 to 30 mm (50 × 50 mm white paper)		1 to 15mm (50 × 50 mm white paper)		1 to 30mm (50 × 50 mm white paper)	
Standard sensing object	---									
Minimum detectable object (typical)	0.15-mm dia. (sensing distance of 10 mm)						0.15-mm dia non-glossy object (sensing distance of 10 mm)			
Hysteresis (white paper)	6 mm max.		2 mm max.		6 mm max.		0.5 mm max.		2 mm max.	
Black/white error	---						15% max.			
Directional angle	---									
Light source (wavelength)	Red LED ("Pin-point" LED) $\lambda = 650$ nm									
Power supply voltage	12 to 24 VDC $\pm 10\%$, ripple (p-p) 10% max.									
Current consumption	20 mA max.									
Control output	Load power supply voltage: 26.4 VDC max. Load current: 50 mA max. (residual voltage: 2 V max. for load current of 10 to 50 mA, 1 V max. for load current of less than 10 mA) Open-collector output Light ON: E3T-□□□1 and E3T-□□□3 Dark ON: E3T-□□□2 and E3T-□□□4									
Protection circuits	Power supply and control output reverse polarity protection Output short-circuit protection, Mutual interference prevention									
Response time	Operate or reset: 1 ms max.									
Ambient illumination	Incandescent lamp: 5,000 lx max.					Sunlight: 10,000 lx max.				
Ambient temperature range	Operating: -25 to 55°C					Storage: -40 to 70°C (with no icing or condensation)				
Ambient humidity range	Operating: 35% to 85%					Storage: 35% to 95% (with no condensation)				
Insulation resistance	20 M Ω min. at 500 VDC									
Dielectric strength	1,000 VAC, 50/60 Hz for 1 min									
Vibration resistance	Destruction: 10 to 2,000 Hz, 1.5-mm double amplitude or 300 m/s ² for 0.5 hrs each in X, Y, and Z directions									
Shock resistance	Destruction: 1,000 m/s ² 3 times each in X, Y, and Z directions									
Degree of protection	IP67 (IEC60529)									
Connection method	Pre-wired (standard length: 2 m)									
Weight	Approx. 20 g									
Materials	Case	PBT (polybutylene terephthalate)								
	Display window	Denatured polyarylate								
	Lens	Denatured polyarylate								
Accessories	Instruction manual, Installation Phillips screws (Side-view Models: M2 × 14, Flat Models: M2 × 8), Nuts, Spring washers, Flat washers									

Engineering Data (Typical)

Parallel Operating Range

Through-beam

E3T-ST1□ + E39-S63 Slit
(Order Separately)
(A Slit is mounted to the Emitter and Receiver.)



E3T-ST1□ + E39-S63 Slit
(Order Separately) (Enlarged graph)
(A Slit is mounted to the Emitter and Receiver.)



E3T-ST2□ + E39-S63 Slit
(A Slit is mounted to the Emitter and Receiver.)



E3T-FT1□ + E39-S64 Slit
(Order Separately)
(A Slit is mounted to the Emitter and Receiver.)



E3T-FT1□ + E39-S64 Slit
(Order Separately) (Enlarged graph)
(A Slit is mounted to the Emitter and Receiver.)



E3T-FT2□ + E39-S64 Slit
(A Slit is mounted to the Emitter and Receiver.)



Retro-reflective

E3T-SR4□



Operating Range

Diffuse-reflective

E3T-FD1



Convergent-reflective

E3T-SL1



E3T-SL2



BGS Reflective

E3T-FL1



E3T-FL2



Inclination Detection Area Characteristic

Convergent-reflective

E3T-SL1 (Top to Bottom)



E3T-SL1 (Right to Left)



E3T-SL2 (Top to Bottom)



BGS Reflective

E3T-SL2 (Right to Left)



E3T-FL1 (Top to Bottom)



E3T-FL1 (Right to Left)



E3T-FL2 (Top to Bottom)



E3T-FL2 (Right to Left)



Excess Gain vs. Set Distance

Through-beam

E3T-ST1



E3T-FT1



E3T-ST2



E3T-FT2

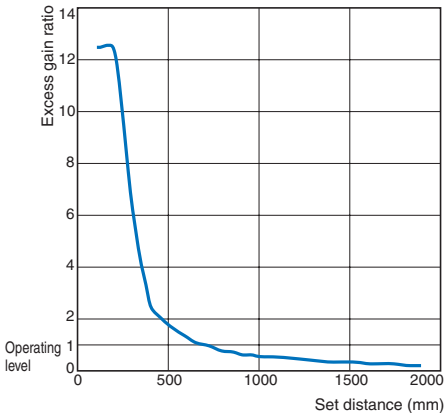

Retro-reflective

E3T-SR4



Diffuse-reflective

E3T-FD1

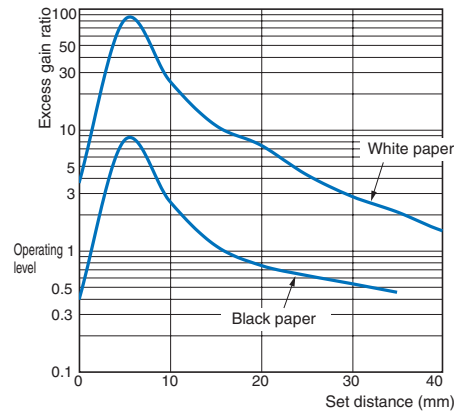

Convergent-reflective

E3T-SL1

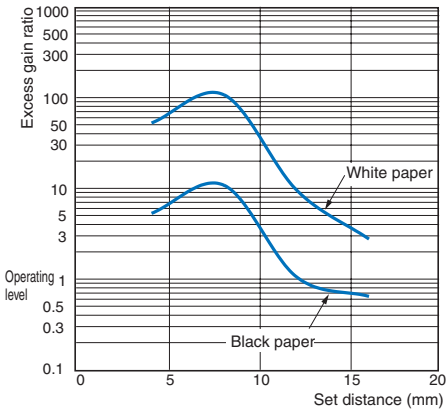

E3T-SL2



Sensing Object Size vs. Sensing Distance

Convergent-reflective

E3T-SL1

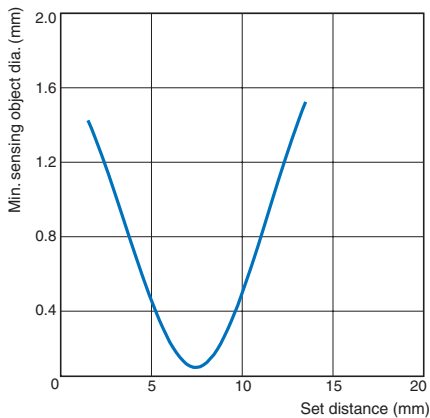

Diffuse-reflective, Convergent-reflective

E3T-FD1, E3T-SL2



Sensing Distance vs. Material

Convergent-reflective

E3T-SL1



E3T-SL2



Diffuse-reflective

E3T-FD1



BGS Reflective

E3T-FL1



E3T-FL2



Sensing Distance Characteristics of Sensitivity Adjustment Unit (when Completing Optical Axis Adjustment)

E3T-ST1 + E39-E10 Sensitivity Adjustment Unit (Order Separately) for Emitter



I/O Circuit Diagrams

NPN Output

Model *	Operation mode	Timing charts	Output circuit
E3T-□□□1	Light-ON		<p>Through-beam Receivers, Retroreflective and Reflective Models</p> <p>Connector Pin Arrangement M12 e-CON</p> <p>Note: Pin 2 is not used. Pins 2 and 4 are not used with Through-beam Emitters.</p>
E3T-□□□2	Dark-ON		<p>Through-beam Emitters</p> <p>Connector Pin Arrangement M12 e-CON</p> <p>Note: Pin 2 is not used. Pins 2 and 4 are not used with Through-beam Emitters.</p>

PNP Output

Model *	Operation mode	Timing charts	Output circuit
E3T-□□□3	Light-ON		<p>Through-beam Receivers, Retroreflective and Reflective Models</p> <p>Connector Pin Arrangement M12 e-CON</p> <p>Note: Pin 2 is not used. Pins 2 and 4 are not used with Through-beam Emitters.</p>
E3T-□□□4	Dark-ON		<p>Through-beam Emitters</p> <p>Connector Pin Arrangement M12 e-CON</p> <p>Note: Pin 2 is not used. Pins 2 and 4 are not used with Through-beam Emitters.</p>

* Models numbers for Through-beam Sensors (E3T-□□□□) are for sets that include both the Emitter and Receiver. The model number of the Emitter is expressed by adding "-L" to the set model number (example: E3T-ST11-L 2M), the model number of the Receiver, by adding "-D" (example: E3T-ST11-D 2M.) Refer to *Ordering Information* to confirm model numbers for Emitter and Receivers.

Plugs (Sensor I/O Connectors)

M12 Connector



e-CON connector



Pin arrangement

Classification	Wire color	Connector pin No.	Application
DC	Brown	1	Power supply (+V)
	White	2	---
	Blue	3	Power supply (0 V)
	Black	4	Output

Note: Pin 2 is not used.

Safety Precautions

Refer to *Warranty and Limitations of Liability*.

WARNING

This product is not designed or rated for ensuring safety of persons. Do not use it for such purpose.



Do not apply AC power to the E3T, otherwise the E3T may rupture.



Precautions for Correct Use

Do not use the product in atmospheres or environments that exceed product ratings.

● Wiring

The maximum power supply voltage is 24 VDC +10%. Before turning the power ON, make sure that the power supply voltage is not more than maximum voltage.

Load short-circuit protection

The E3T incorporates a load short-circuit protection function. If the load short-circuits, the output of the E3T will be turned OFF. Then, recheck the wiring and turn on the E3T again to reset the load short-circuit protection function. The load short-circuit protection function will work if there is a current flow that is 1.5 times larger than the rated load current. When using a capacitance load, be sure that the inrush current will not exceed 1.5 times larger than the rated current.

● Mounting

When mounting the Sensor, never strike it with a heavy object, such as a hammer. Doing so may reduce its watertight properties. Use M2 screws and flat or spring washers to secure the Sensor. (Tightening torque: 0.15 N·m max.)

Mounting the Sensor on Moving Parts

Consider models that use break resistant cables (e.g., Robotics Cables) if the Sensor will be mounted on a moving part, such as a robot hand. The flexing resistance of Robotics Cable at approximately 400 thousand times is far superior to that of standard cable at approximately 14 thousand times.



Cable Bending Rupture Test (Tough Cable Breaking Test)

The cable is repeatedly bent with power supplied to check the number of bends until the current is turned OFF.

Test	Specimen	Standard cable 2.4-mm dia. (7/0.127-mm dia.), 3 conductors	Robotics cable 2.4-mm dia. (20/0.08-mm dia.), 3 conductors
Con- tents/ condi- tions	Bending angle (θ)	90° each to the left and right	
	Bending speed	50 times/min	
	Load	200 g	
	Operation per bend	Once in 1 to 3 in the diagram	
	Curvature radius of support point (R)	5 mm	
Result		Approx. 14,000 times	Approx. 400,000 times

● Adjusting

Indicators

- The following graphs indicate the status of each operating level.
- Be sure to use the E3T within the stable operating range.

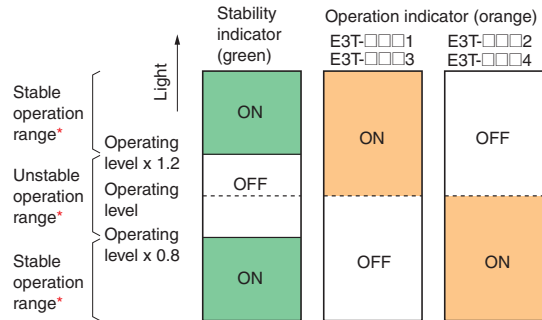

*If the E3T fs operating level is set to the stable operation range, the E3T will be in most reliable operation without being influenced by temperature change, voltage fluctuation, dust, or setting change. If the operating level cannot be set to the stable operation range, pay attention to environmental changes while operating the E3T.

Use of E39-E10 Sensitivity Adjustment Unit

(Dark-ON: E3T-ST12)



1. Mount the Unit on the Receiver.
2. Set the adjuster of the Sensitivity Adjustment Unit to Max. (Before shipping: Max.)
3. After mounting on the Sensor, adjust the optical axis and secure the Sensor.
4. Place a workpiece between the Emitter and Receiver and gradually turn the adjuster counterclockwise toward the Min. side. Stop turning the adjuster when the operation indicator and stability indicator (green) turn ON.
5. Remove the workpiece and confirm that the operation indicator is OFF and the stability indicator (green) is ON. This completes the adjustment.

Note: If the light attenuation rate due to a workpiece is 40% or less, the stability indicator will not turn ON whether or not light is received. When the variation of light is small such as when sensing semi-transparent workpieces, carefully perform preliminary testing.

● Others

Do not install the E3T in the following locations.

- Locations subject to excessive dust or dirt
- Locations subject to direct sunlight
- Locations subject to corrosive gas
- Locations subject to contact with organic solvents
- Locations subject to vibration and shock
- Locations subject to contact with water, oil, or chemicals
- Locations subject to high humidities that might result in condensation

Dimensions

(Unit: mm)

Tolerance class IT16 applies to dimensions in this datasheet unless otherwise specified.

Sensors

Through-beam Models

(Side-view) *

E3T-ST1□ (Emitter)

E3T-ST2□ (Emitter)



Emitter: E3T-ST□□-L
Receiver: E3T-ST□□-D



M12 Smartclick Pre-wired Connector Model (E3T-ST□□-M12J)



E3T-ST1□ (Receiver)

E3T-ST2□ (Receiver)



e-CON Pre-wired Connector Model (E3T-ST□□-ECON)



Through-beam Models (Flat) *

E3T-FT1□ (Emitter)

E3T-FT2□ (Emitter)



Emitter: E3T-FT□□-L
Receiver: E3T-FT□□-D



Terminal No.	Specifications
1	+V
2	---
3	0 V
4	Output (receiver only)

* Refer to *Mounting the Sensor on Moving Parts* on page 14 for details on Robotics Cable models.

E3T-FT1□ (Receiver)

E3T-FT2□ (Receiver)



* Models numbers for Through-beam Sensors (E3T-□□□□) are for sets that include both the Emitter and Receiver.

The model number of the Emitter is expressed by adding "-L" to the set model number (example: E3T-ST11-L 2M), the model number of the Receiver, by adding "-D" (example: E3T-ST11-D 2M.) Refer to *Ordering Information* to confirm model numbers for Emitter and Receivers.

Retro-reflective Models (Side-view)

E3T-SR4□



M12 Smartclick Pre-wired Connector Model (E3T-SR□□-M1TJ/E3T-SL□□-M1TJ/E3T-FD□□-M1TJ)



Convergent-reflective Models (Side-view)

E3T-SL1□

E3T-SL2□

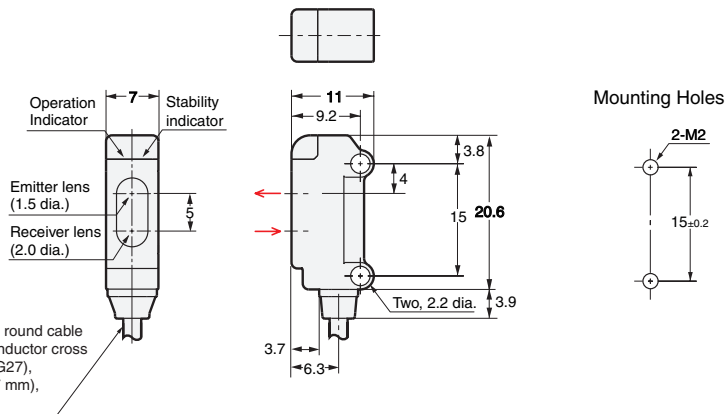

e-CON Pre-wired Connector (E3T-SR□□-ECON/E3T-SL□□-ECON/E3T-FD□□-ECON)



Terminal No.	Specifications
1	+V
2	---
3	0 V
4	Output

Diffuse-reflective Models (Flat)

E3T-FD1□



* Refer to *Mounting the Sensor on Moving Parts* on page 14 for details on Robotics Cable models.

BGS Models (Flat)

- E3T-FL1□
- E3T-FL2□



2.4-dia. vinyl-insulated round cable with 3 conductors (Conductor cross section: 0.1 mm² (AWG27), Insulator diameter: 0.7 mm), Standard length: 2 m

Mounting Holes

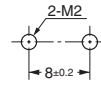

M12 Smartclick Pre-wired Connector Model (E3T-FL□-M1TJ)

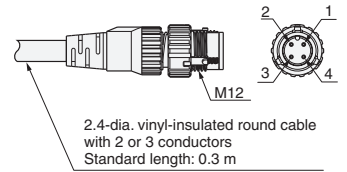

e-CON Pre-wired Connector (E3T-FL□-ECON)

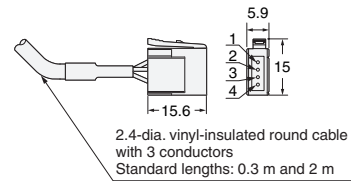

Terminal No.	Specifications
1	+V
2	---
3	0 V
4	Output

* Refer to *Mounting the Sensor on Moving Parts* on page 14 for details on Robotics Cable models.

Accessories

Reflector (Provided with E3T-SR4□)

E39-R4

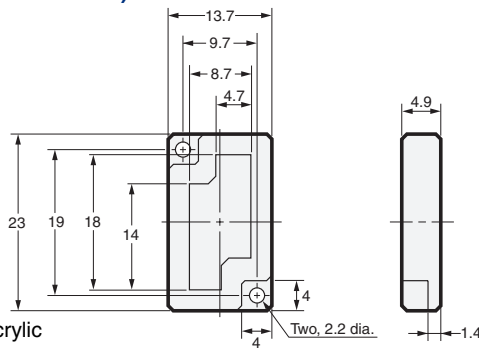

Material, reflective surface: acrylic
Rear surface: ABS

Reflector (Provided with E3T-SR4□-S)

E39-R37-CA

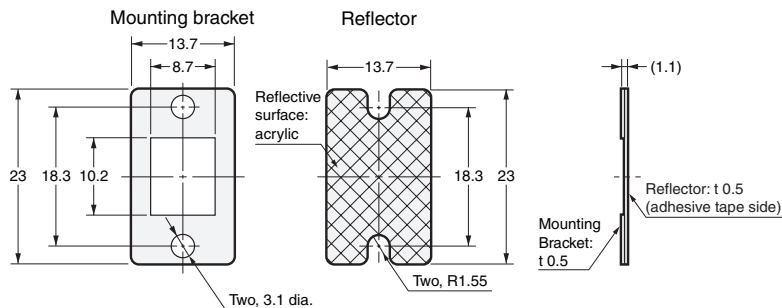

Material: Mounting plate: stainless steel (SUS301)
Reflective surface: acrylic

Note: The reflective plate and mounting plate (1) come as a set.

Mounting Brackets for Side-view Models

E39-L117



Material: 1.2-mm-thick stainless steel (SUS304)



Mounting Brackets for Side-view Models

E39-L118



Material: 1.2-mm-thick stainless steel (SUS304)



Mounting Brackets for Flat Models

E39-L119



Material: 1.2-mm-thick stainless steel (SUS304)



With Mounting Bracket
(Example: E3T-FT11)



Mounting Brackets for Flat Models

E39-L120



Material: 1.2-mm-thick stainless steel (SUS304)



With Mounting Bracket
(Example: E3T-FT11)



Read and Understand This Catalog

Please read and understand this catalog before purchasing the products. Please consult your OMRON representative if you have any questions or comments.

Warranty and Limitations of Liability

WARRANTY

OMRON's exclusive warranty is that the products are free from defects in materials and workmanship for a period of one year (or other period if specified) from date of sale by OMRON.

OMRON MAKES NO WARRANTY OR REPRESENTATION, EXPRESS OR IMPLIED, REGARDING NON-INFRINGEMENT, MERCHANTABILITY, OR FITNESS FOR PARTICULAR PURPOSE OF THE PRODUCTS. ANY BUYER OR USER ACKNOWLEDGES THAT THE BUYER OR USER ALONE HAS DETERMINED THAT THE PRODUCTS WILL SUITABLY MEET THE REQUIREMENTS OF THEIR INTENDED USE. OMRON DISCLAIMS ALL OTHER WARRANTIES, EXPRESS OR IMPLIED.

LIMITATIONS OF LIABILITY

OMRON SHALL NOT BE RESPONSIBLE FOR SPECIAL, INDIRECT, OR CONSEQUENTIAL DAMAGES, LOSS OF PROFITS OR COMMERCIAL LOSS IN ANY WAY CONNECTED WITH THE PRODUCTS, WHETHER SUCH CLAIM IS BASED ON CONTRACT, WARRANTY, NEGLIGENCE, OR STRICT LIABILITY.

In no event shall the responsibility of OMRON for any act exceed the individual price of the product on which liability is asserted.

IN NO EVENT SHALL OMRON BE RESPONSIBLE FOR WARRANTY, REPAIR, OR OTHER CLAIMS REGARDING THE PRODUCTS UNLESS OMRON'S ANALYSIS CONFIRMS THAT THE PRODUCTS WERE PROPERLY HANDLED, STORED, INSTALLED, AND MAINTAINED AND NOT SUBJECT TO CONTAMINATION, ABUSE, MISUSE, OR INAPPROPRIATE MODIFICATION OR REPAIR.

Application Considerations

SUITABILITY FOR USE

OMRON shall not be responsible for conformity with any standards, codes, or regulations that apply to the combination of products in the customer's application or use of the products.

At the customer's request, OMRON will provide applicable third party certification documents identifying ratings and limitations of use that apply to the products. This information by itself is not sufficient for a complete determination of the suitability of the products in combination with the end product, machine, system, or other application or use.

The following are some examples of applications for which particular attention must be given. This is not intended to be an exhaustive list of all possible uses of the products, nor is it intended to imply that the uses listed may be suitable for the products:

- Outdoor use, uses involving potential chemical contamination or electrical interference, or conditions or uses not described in this catalog.
- Nuclear energy control systems, combustion systems, railroad systems, aviation systems, medical equipment, amusement machines, vehicles, safety equipment, and installations subject to separate industry or government regulations.
- Systems, machines, and equipment that could present a risk to life or property.

Please know and observe all prohibitions of use applicable to the products.

NEVER USE THE PRODUCTS FOR AN APPLICATION INVOLVING SERIOUS RISK TO LIFE OR PROPERTY WITHOUT ENSURING THAT THE SYSTEM AS A WHOLE HAS BEEN DESIGNED TO ADDRESS THE RISKS, AND THAT THE OMRON PRODUCTS ARE PROPERLY RATED AND INSTALLED FOR THE INTENDED USE WITHIN THE OVERALL EQUIPMENT OR SYSTEM.

PROGRAMMABLE PRODUCTS

OMRON shall not be responsible for the user's programming of a programmable product, or any consequence thereof.

Disclaimers

CHANGE IN SPECIFICATIONS

Product specifications and accessories may be changed at any time based on improvements and other reasons.

It is our practice to change model numbers when published ratings or features are changed, or when significant construction changes are made. However, some specifications of the products may be changed without any notice. When in doubt, special model numbers may be assigned to fix or establish key specifications for your application on your request. Please consult with your OMRON representative at any time to confirm actual specifications of purchased products.

DIMENSIONS AND WEIGHTS

Dimensions and weights are nominal and are not to be used for manufacturing purposes, even when tolerances are shown.

PERFORMANCE DATA

Performance data given in this catalog is provided as a guide for the user in determining suitability and does not constitute a warranty. It may represent the result of OMRON's test conditions, and the users must correlate it to actual application requirements. Actual performance is subject to the OMRON Warranty and Limitations of Liability.

ERRORS AND OMISSIONS

The information in this document has been carefully checked and is believed to be accurate; however, no responsibility is assumed for clerical, typographical, or proofreading errors, or omissions.

2010.11

In the interest of product improvement, specifications are subject to change without notice.

OMRON Corporation
Industrial Automation Company

<http://www.ia.omron.com/>

(c)Copyright OMRON Corporation 2010 All Right Reserved.

Mouser Electronics

Authorized Distributor

Click to View Pricing, Inventory, Delivery & Lifecycle Information:

Omron:

[E39-L131](#) [E39-L116](#) [E39-G4](#) [E39-RS5](#) [E39-R14](#) [E39-RS4](#) [E39-R12](#) [E39-R13](#) [E39-L102](#) [E39-L103](#) [E39-L143](#)
[E39F9](#) [E39-P41](#) [E39-P21](#) [E39-P31](#) [E39-T1](#) [E39-R2](#) [E39-T3](#) [E39-R3](#) [E39-R4](#) [E39-R1](#) [E39-F1](#) [E39-T2](#) [E39-E6](#)
[E3T-ST12](#) [E3T-ST11](#) [E39-RSB](#) [E39-RSA](#) [E3T-FD12](#) [E39-P11](#) [E39-L69](#) [E39-L60](#) [E39-LU1](#) [E39-L70](#) [E39-L59](#)
[E3T-SL11](#) [E3T-SL12](#) [E3T-ST14](#) [E3T-SL21](#) [E3T-SR21 2M](#) [E3T-SR22 2M](#) [E39-ECON2M](#) [E39-ECON5M](#) [E3T-FT11](#)
[E39-C1 5M](#) [E39-E10](#) [E39-E11](#) [E39-E8](#) [E39-F10](#) [E39-F1-31](#) [E39-F1-33](#) [E39-F14](#) [E39-F15](#) [E39-F1V](#) [E39-F2-32](#)
[E39-F3](#) [E39-F31](#) [E39-F32A](#) [E39-F32A5](#) [E39-F32B](#) [E39-F32B5](#) [E39-F32C](#) [E39-F32C5](#) [E39-F32D](#) [E39-F32D5](#)
[E39-F3A](#) [E39-F3B](#) [E39-F3C](#) [E39-F4](#) [E39-F4-SD](#) [E39-F5](#) [E39-FU1](#) [E39-FU1-1](#) [E39-G10](#) [E39-G12](#) [E39-G3](#) [E39-](#)
[G9](#) [E39-L109](#) [E39-L113](#) [E39-L114](#) [E39-L115](#) [E39-L119](#) [E39-L120](#) [E39-L127-T1](#) [E39-L127-T2](#) [E39-L127-T3](#) [E39-](#)
[L129](#) [E39-L132](#) [E39-L135](#) [E39-L136](#) [E39-L139](#) [E39-L142](#) [E39-L150](#) [E39-L151](#) [E39-L153](#) [E39-L3](#) [E39-L31](#) [E39-](#)
[L34](#) [E39-L35](#) [E39-L37](#)

Данный компонент на территории Российской Федерации

Вы можете приобрести в компании MosChip.

Для оперативного оформления запроса Вам необходимо перейти по данной ссылке:

<http://moschip.ru/get-element>

Вы можете разместить у нас заказ для любого Вашего проекта, будь то серийное производство или разработка единичного прибора.

В нашем ассортименте представлены ведущие мировые производители активных и пассивных электронных компонентов.

Нашей специализацией является поставка электронной компонентной базы двойного назначения, продукции таких производителей как XILINX, Intel (ex.ALTERA), Vicor, Microchip, Texas Instruments, Analog Devices, Mini-Circuits, Amphenol, Glenair.

Сотрудничество с глобальными дистрибьюторами электронных компонентов, предоставляет возможность заказывать и получать с международных складов практически любой перечень компонентов в оптимальные для Вас сроки.

На всех этапах разработки и производства наши партнеры могут получить квалифицированную поддержку опытных инженеров.

Система менеджмента качества компании отвечает требованиям в соответствии с ГОСТ Р ИСО 9001, ГОСТ РВ 0015-002 и ЭС РД 009

Офис по работе с юридическими лицами:

105318, г.Москва, ул.Щербаковская д.3, офис 1107, 1118, ДЦ «Щербаковский»

Телефон: +7 495 668-12-70 (многоканальный)

Факс: +7 495 668-12-70 (доб.304)

E-mail: info@moschip.ru

Skype отдела продаж:

moschip.ru

moschip.ru_4

moschip.ru_6

moschip.ru_9