



SERIES: PSK-15B | DESCRIPTION: AC-DC POWER SUPPLY

FEATURES

- up to 15 W continuous power
- universal input: 85~264 Vac
- compact encapsulated design
- single output from 5 Vdc ~ 48 Vdc
- short circuit, over voltage protection, over current protection
- 4000 Vac isolation
- no load power consumption <100 mW



| MODEL | output voltage | output current | output power | ripple and noise ¹ | efficiency |
|-------------|----------------|----------------|--------------|-------------------------------|------------|
| | (Vdc) | max (A) | max (W) | typ (mVp-p) | typ (%) |
| PSK-15B-S5 | 5 | 2.8 | 14 | 100 | 81.37 |
| PSK-15B-S9 | 9 | 1.6 | 14.4 | 100 | 84.28 |
| PSK-15B-S12 | 12 | 1.25 | 15 | 120 | 84.50 |
| PSK-15B-S15 | 15 | 1 | 15 | 150 | 84.50 |
| PSK-15B-S24 | 24 | 0.625 | 15 | 240 | 84.50 |
| PSK-15B-S48 | 48 | 0.32 | 15.4 | 480 | 84.63 |

Notes: 1. At full load, nominal input, 20 MHz bandwidth oscilloscope, output terminated with 10 μ F electrolytic and 0.1 μ F ceramic capacitors.
2. All specifications are measured at $T_a=25^\circ\text{C}$, nominal input voltage, and 75% rated output load unless otherwise specified.

PART NUMBER KEY

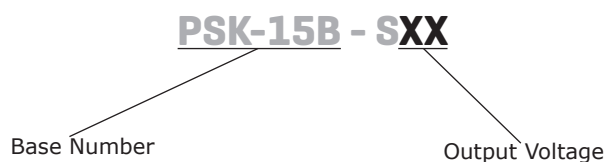

INPUT

| parameter | conditions/description | min | typ | max | units |
|---------------------------|------------------------------|-----------|-----|------------|------------|
| voltage | | 85 120 | | 264 370 | Vac Vdc |
| frequency | | 47 | | 63 | Hz |
| current | | | | 0.4 | A |
| inrush current | at 240 Vac, 25°C, cold start | | | 60 | A |
| leakage current | | | | 0.25 | mA |
| no load power consumption | | | | 0.10 | W |

OUTPUT

| parameter | conditions/description | min | typ | max | units |
|----------------------------|------------------------------------|-----|-------|-------|-------|
| capacitive load | 5 Vdc output model | | | 2,800 | μF |
| | 9 Vdc output model | | | 1,600 | μF |
| | 12 Vdc output model | | | 1,250 | μF |
| | 15 Vdc output model | | | 1,000 | μF |
| | 24 Vdc output model | | | 625 | μF |
| | 48 Vdc output model | | | 320 | μF |
| initial set point accuracy | at full load, 25°C | | ±2 | | % |
| line regulation | high line to low line at full load | | ±0.5 | | % |
| load regulation | 10%~100% load | | ±1 | | % |
| hold-up time | at 115 Vac | | 12 | | ms |
| switching frequency | | | 65 | | kHz |
| temperature coefficient | | | ±0.05 | | %/°C |

PROTECTIONS

| parameter | conditions/description | min | typ | max | units |
|--------------------------|------------------------|-----|-----|-----|-------|
| over voltage protection | hiccup, auto recovery | | | | |
| over current protection | | 110 | | | % |
| short circuit protection | hiccup, auto recovery | | | | |

SAFETY & COMPLIANCE

| parameter | conditions/description | min | typ | max | units |
|-------------------|---|---------|-------|-----|-------|
| isolation voltage | input to output | | 4,000 | | Vac |
| safety approvals | IEC62368-1/60950-1, UL62368-1/60950-1 | | | | |
| safety class | class II | | | | |
| EMI/EMC | EN 55032 Class B, FCC Part 15 Class B, EN 61000-6-3, EN 61000-3-2, EN 61000-3-3, EN 55024, EN 61204-3, EN 61000-6-1 | | | | |
| MTBF | as per MIL-STD-217F, at 115 Vac, 25°C, GB | 300,000 | | | hours |
| life time | at 40°C, 75% load | 3 | | | years |
| RoHS | yes | | | | |

ENVIRONMENTAL

| parameter | conditions/description | min | typ | max | units |
|-----------------------|------------------------|-----|------|-----|-------|
| operating temperature | see derating curve | -25 | | 70 | °C |
| storage temperature | | -40 | | 85 | °C |
| operating humidity | non-condensing | | | 93 | % |
| operating altitude | | | 5000 | | m |

SOLDERABILITY

| parameter | conditions/description | min | typ | max | units |
|----------------|----------------------------|-----|-----|-----|-------|
| wave soldering | see wave soldering profile | | | 260 | °C |

- Notes:
1. Soldering materials: Sn/Cu/Ni
 2. Ramp up rate during preheat: 1.4°C/s (from 50°C to 100°C)
 3. Soaking temperature: 0.5°C/s (from 100°C to 130°C), 60±20 seconds
 4. Peak temperature: 260°C, above 250°C for 3~6 seconds
 5. Ramp down rate during cooling: -10°C/s (from 260°C to 150°C)

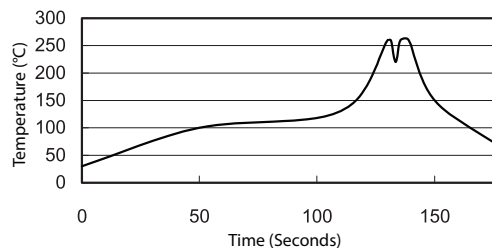

MECHANICAL

| parameter | conditions/description | min | typ | max | units |
|------------|--|-----|-----|-----|-------|
| dimensions | 2.440 x 1.770 x 0.909 (61.98 x 44.96 x 23.09 mm) | | | | inch |
| weight | | | 104 | | g |
| cooling | natural convection | | | | |

MECHANICAL DRAWING

units: inch [mm]
 tolerance: X.XXX = ±0.020 [±0.50]

| PIN CONNECTIONS | |
|-----------------|----------|
| PIN | Function |
| 1 | ACN |
| 2 | ACL |
| 3 | -Vout |
| 4 | +Vout |

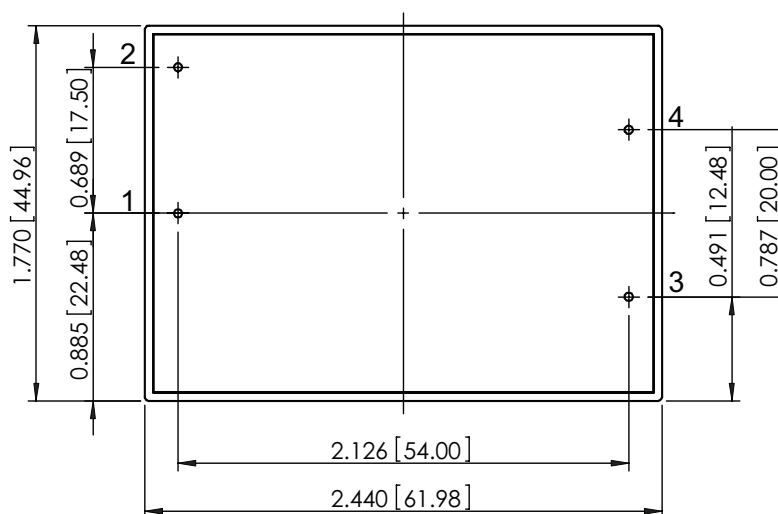
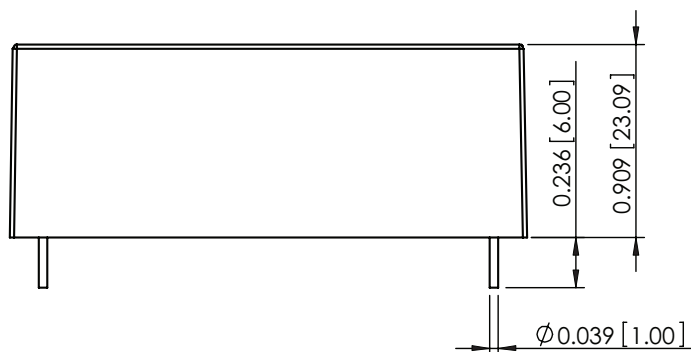

DERATING CURVE

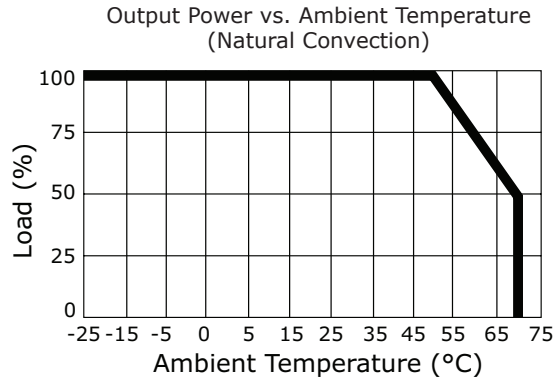

EFFICIENCY CURVES

5 Vdc Output Efficiency Curve
(at 25°C)

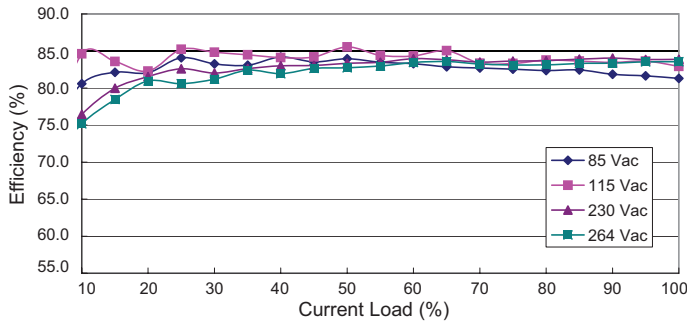

9 Vdc Output Efficiency Curve
(at 25°C)

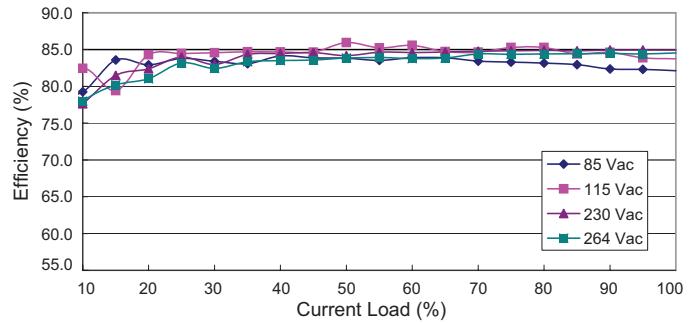

12 Vdc Output Efficiency Curve
(at 25°C)

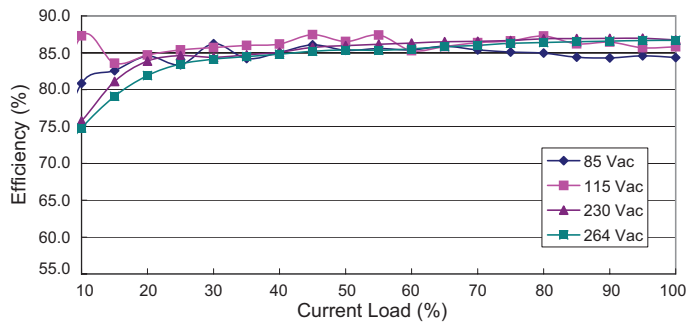

15 Vdc Output Efficiency Curve
(at 25°C)

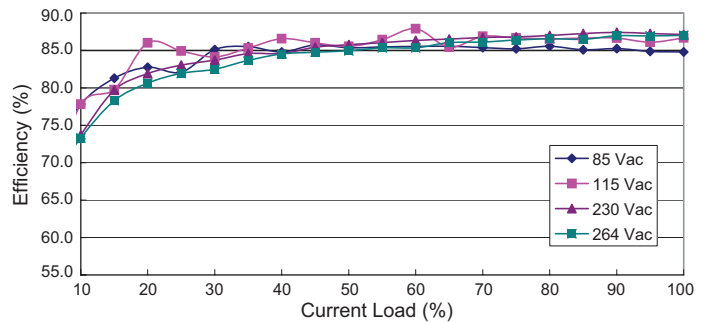

24 Vdc Output Efficiency Curve
(at 25°C)

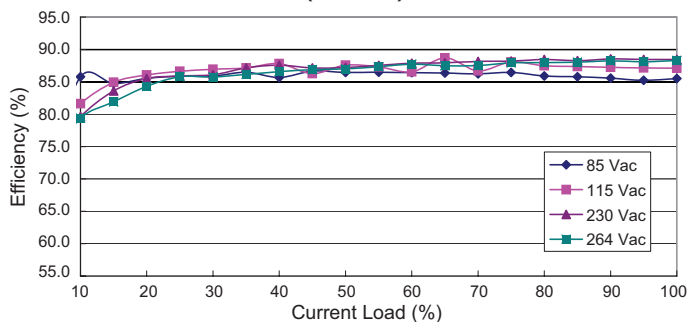

48 Vdc Output Efficiency Curve
(at 25°C)

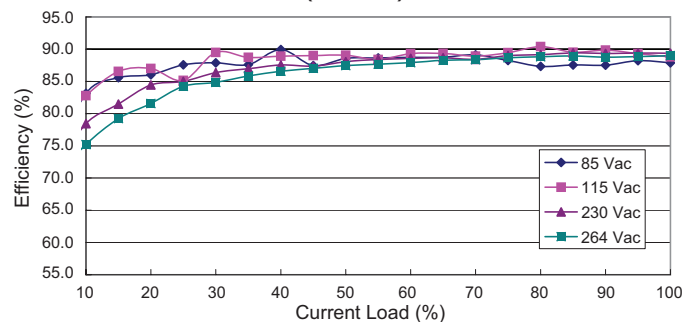

REVISION HISTORY

| rev. | description | date |
|------|------------------------------|------------|
| 1.0 | initial release | 02/23/2017 |
| 1.01 | increased operating altitude | 02/05/2018 |
| 1.02 | updated datasheet | 01/08/2019 |

The revision history provided is for informational purposes only and is believed to be accurate.



Headquarters
20050 SW 112th Ave.
Tualatin, OR 97062
800.275.4899

Fax 503.612.2383
cui.com
techsupport@cui.com

CUI offers a two (2) year limited warranty. Complete warranty information is listed on our website.

CUI reserves the right to make changes to the product at any time without notice. Information provided by CUI is believed to be accurate and reliable. However, no responsibility is assumed by CUI for its use, nor for any infringements of patents or other rights of third parties which may result from its use.

CUI products are not authorized or warranted for use as critical components in equipment that requires an extremely high level of reliability. A critical component is any component of a life support device or system whose failure to perform can be reasonably expected to cause the failure of the life support device or system, or to affect its safety or effectiveness.

Данный компонент на территории Российской Федерации

Вы можете приобрести в компании MosChip.

Для оперативного оформления запроса Вам необходимо перейти по данной ссылке:

<http://moschip.ru/get-element>

Вы можете разместить у нас заказ для любого Вашего проекта, будь то серийное производство или разработка единичного прибора.

В нашем ассортименте представлены ведущие мировые производители активных и пассивных электронных компонентов.

Нашей специализацией является поставка электронной компонентной базы двойного назначения, продукции таких производителей как XILINX, Intel (ex.ALTERA), Vicor, Microchip, Texas Instruments, Analog Devices, Mini-Circuits, Amphenol, Glenair.

Сотрудничество с глобальными дистрибьюторами электронных компонентов, предоставляет возможность заказывать и получать с международных складов практически любой перечень компонентов в оптимальные для Вас сроки.

На всех этапах разработки и производства наши партнеры могут получить квалифицированную поддержку опытных инженеров.

Система менеджмента качества компании отвечает требованиям в соответствии с ГОСТ Р ИСО 9001, ГОСТ РВ 0015-002 и ЭС РД 009

Офис по работе с юридическими лицами:

105318, г.Москва, ул.Щербаковская д.3, офис 1107, 1118, ДЦ «Щербаковский»

Телефон: +7 495 668-12-70 (многоканальный)

Факс: +7 495 668-12-70 (доб.304)

E-mail: info@moschip.ru

Skype отдела продаж:

moschip.ru

moschip.ru_4

moschip.ru_6

moschip.ru_9