

MEMS Flow Sensors **D6F series**

Series Catalog

Faster and more accurate than ever before ———

MEMS flow sensor : the ideal means for mass flow measurement

Omron flow sensor
so precise
even the flap of a butterfly's
wings will not be missed.



Realizing a highly accurate flow measurement,

Omron's MEMS flow sensor accurately detects minute airflow so much as a single flap of a butterfly's wings. A gas flow sensor capable of "measuring mass flow" independent of temperature and pressure.



D6F-A6



D6F-W

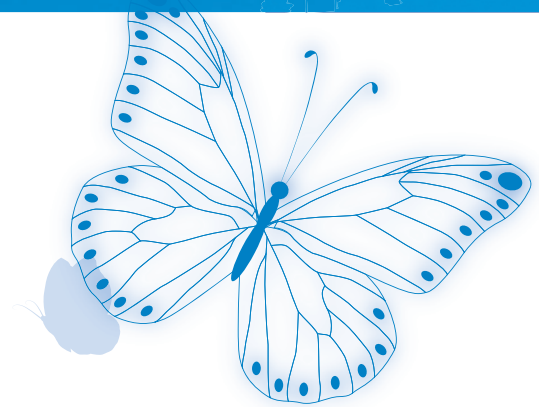

Mass Flow Measurement

Q1 There are two balloons; each having different volumes. But these balloons have the same mass. Why is that?

A The volume increases/decreases according to the pressure and temperature changes. The mass, on the other hand, remains constant regardless of the environmental changes. The mass flow measurement allows measurement performance that is not affected by the changes in the environment.

Q2 Why is mass flow measurement required?

A An accurate measurement of the flow is required especially for combustion control. Omron's flow sensor enables measuring the gas flow based on the mass flow measurement.

Principles of MEMS Flow D6F Series



During the absence of airflow, the temperature distribution around the heater is symmetrical. When there is airflow, the temperature of the upwind side cools down and the temperature of the downwind side warms up, disrupting the symmetry of the temperature distribution.

sensing even a single flap of a butterfly's wings



High Accuracy

$\pm 3RD$ (25-100%F.S.) is realized by linear temperature correction using ASIC technology

Ambient temperature = 25degC (Model: D6F-20A7D-000-0)

Operating characteristic



High Sensitivity

Omron's unique MEMS technology allows detection of very low air velocities

Flow rate of 1L: Output corresponding to flow rate change below 1/1000 of full scale. 1SLM = 1000sccm

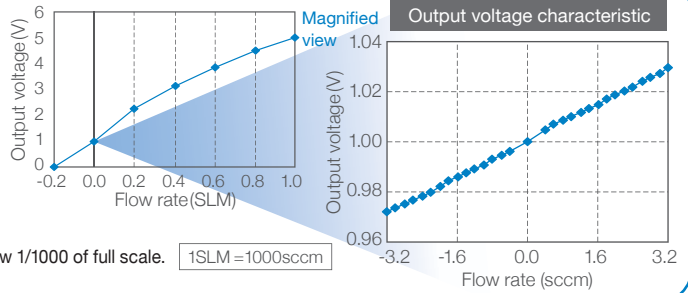

Compact

The product size is reduced by using the world-smallest class size MEMS sensor element

Dimension of D6F-V model: 24x8x14mm.

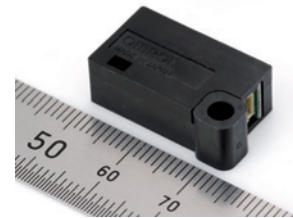

Sensor Measurement



By detecting this temperature difference appearing as a difference in the electromotive forces developed by the thermopiles, it allows the mass flow rate and mass flow velocity to be measured without the influence of temperature and pressure. Since the thermopile generates the thermo-electromotive force, the power consumption is much lower than when using the resistivity method.

Highly Resistant to Dust

Patent No.4534526

Built-in Dust Segregation System (cyclonic) D6F-W/-V/-P

The sensor can be placed anywhere thanks to its dust-resistant structure. Omron's unique design of 3D flow path provides a high level of reliability by separating dust particles to reduce its effect on the sensor chip. Additionally, Omron succeeded in reducing the sensor size, allowing it to be used in wider range of applications.



Applications

Omron flow sensors cover wide range of applications and can be used for different purposes.

Application Examples

Clogging Detection

For monitoring the flow of the cooling air to optimize the cooling efficiency and avoid malfunctions.

- ▶ Flow rate
- ▶ Velocity
- ▶ Differential pressure



Projector



PC



Server

Quiet, low maintenance cost

Combustion Control

For controlling the air/fuel ratio by accurately measuring the mass flow rate

- ▶ Flow rate
- ▶ Differential pressure



Fuel cell

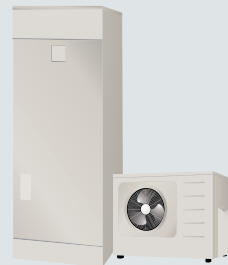

Water heater



Boiler

Optimizing combustion efficiency

Flow measurement

For recording the amount of air used, detecting even the smallest leaks

- ▶ Flow rate
- ▶ Differential pressure



Container manufacturing machine



Mounting machine

Flow visualization, real-time detection

Air volume measurement

For measuring flow rate and flow velocity of a space

- ▶ Velocity
- ▶ Differential pressure



Ducts

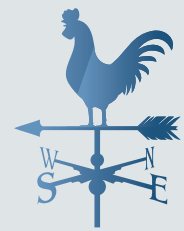

Airflow analysis (environment)



Air conditioner

Monitoring the amount of ventilation, controlling the amount of air at the required level

Selection of Products

Select the most suitable sensor from many variations.

► Flow rate



► Flow velocity

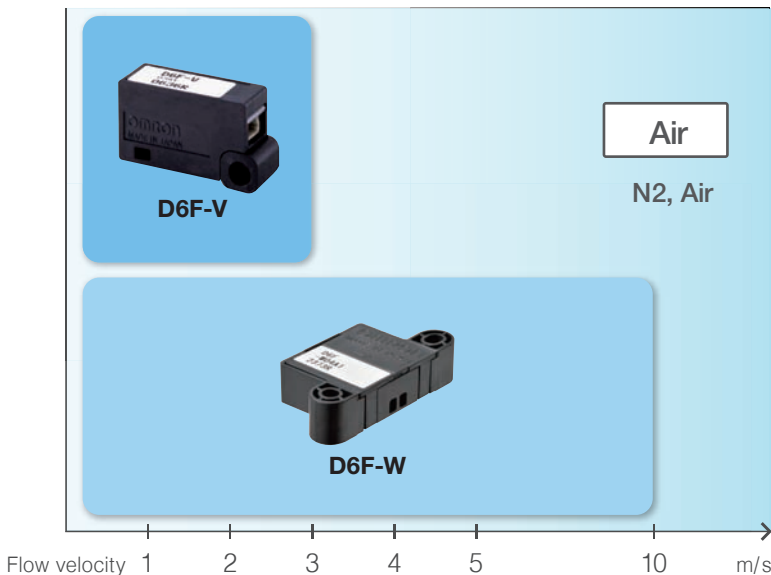

► Differential pressure

Delivers high sensitivity even at low flow rate, low differential pressure

MEMS differential pressure sensor

High precision
Accurate measurement

Low piping effects

High impedance to reduce the influence of piping variations

High reliability

Detect sensor anomaly





List of D6F series

MEMS Flow Sensor





Air
 Minute flow
 Analog

Applicable gas		Air			
Items	Model	D6F-P0001A1	D6F-01A1-110 D6F-P0010A□ D6F-P0010AM2	D6F-02A1-110	D6F-03A3-000
Shape					
Flow rate range (L/min)	5				0~3L/min
	4				
	3				
	2			0~2L/min	
	1	0~0.1L/min	0~1L/min		
	0				
Page		25	8, 25	8	12

Gas
 Minute to middle flow
 Analog







Applicable gas		Natural gas (13A)	LP gas	Natural gas (13A)
Items	Model	D6F-01N2-000	D6F-02L2-000 D6F-02L7-000	D6F-05N2-000 D6F-05N7-000
Shape				
Flow rate range (L/min)	5			0~5L/min
	4			
	3			
	2		0~2L/min	
	1	0~1L/min		
	0			
Page		10	10, 18	10, 16, 18

Air
 Middle to high flow
 Analog
 Digital
 Digital type only

Applicable gas		Air				
Items	Model	D6F-10A5-000 D6F-10A6-000 D6F-10A7-000 D6F-10A7D-000	D6F-20A5-000 D6F-20A6-000 D6F-20A7D-000	D6F-30A7-000 D6F-30AB71-000	D6F-50A5-000 D6F-50A6-000 D6F-50A7D-000	D6F-70AB71-000 D6F-70AB71D-000
Shape						
Flow rate range (L/min)	70					0~70L/min
	60					
	50				0~50L/min	
	40			0~30L/min		
	30	0~10L/min	0~20L/min			
	0					
Page		14, 16, 18, 20	14, 16, 20	18, 23	14, 16, 20	20, 23







MEMS 2-axis flow sensor/ MEMS flow sensor

Air
 Flow velocity
 Analog
 Digital
 Digital type only

Applicable gas		Air				
Items	Model	D6F-D 	D6F-W01A1	D6F-V03A1	D6F-W04A1	D6F-W10A1
Shape						
Flow velocity range (m/s)	10					0~10m/s
	8					
	6					
	4			0~3m/s	0~4m/s	
	2	-1~1m/s	0~1m/s			
	0					
	-2					
Page		35	31	33	31	31

MEMS differential pressure sensor

Air
 Differential pressure
 Digital
 Digital type only

Applicable gas		Air		
Items	Model	D6F-PH0505AD3 	D6F-PH0025AD1 	D6F-PH5050AD3 
Shape				
Differential pressure range (Pa)	500			-500~500Pa
	250			
	50		0~250Pa	
	0	-50~50Pa		
	-50			
	-250			
	-500			
Page			28	

D6F-A1

MEMS Flow Sensor

A Compact, High-accuracy Sensor That Measures Low Flow Rates.

- High accuracy of $\pm 3\%$ FS.
- Flow rates can be measured without being affected by temperature or pressure.



RoHS Compliant



Refer to the *Common Precautions for the D6F Series* on page 40.

Ordering Information

MEMS Flow Sensor

Applicable fluid	Flow rate range	Model
Air	0 to 1 L/min	D6F-01A1-110
	0 to 2 L/min	D6F-02A1-110

Accessory (included)

Type	Model
Cable	D6F-CABLE1

Connections

D6F-01A1-110 D6F-02A1-110

Pin No.	1: Vcc 2: Vout 3: GND
Connector	53398-03** (Made by Molex Japan)

Use the following connectors for connections to the D6F:
 Housing 51021-0300 (Made by Molex Japan)
 Terminals 50079 (Made by Molex Japan)
 Wires AWG28 to AWG26

Tubes Install tubes made of materials such as rubber or urethane so that they will not come out.
 For urethane tubes, tubes with an outer diameter of 12 mm and an inner diameter of 8 mm are recommended.



Output Voltage Characteristics

D6F-01A1-110

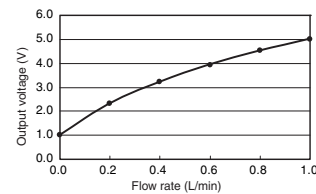

D6F-02A1-110

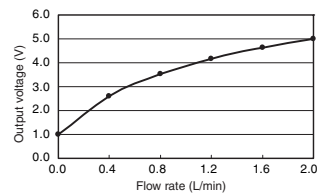

D6F-01A1-110

Flow rate L/min (normal)	0	0.2	0.4	0.6	0.8	1.0
Output voltage V	1.00	2.31	3.21	3.93	4.51	5.00
	± 0.12	± 0.12	± 0.12	± 0.12	± 0.12	± 0.12

D6F-02A1-110

Flow rate L/min (normal)	0	0.4	0.8	1.2	1.6	2.0
Output voltage V	1.00	2.59	3.53	4.18	4.65	5.00
	± 0.12	± 0.12	± 0.12	± 0.12	± 0.12	± 0.12

Measurement conditions: Power supply voltage of 12 ± 0.1 VDC, ambient temperature of 25 ± 5 °C, and ambient humidity of 35% to 75%.

Characteristics/Performance

Model	D6F-01A1-110	D6F-02A1-110
Flow Range (See note 1.)	0 to 1 L/min	0 to 2 L/min.
Calibration Gas (See note 2.)	Air	
Flow Port Type	Bamboo joint Maximum outside diameter: 8.6 mm, Minimum outside diameter: 7.4 mm	
Electrical Connection	Three-pin connector	
Power Supply	10.8 to 26.4 VDC	
Current Consumption	15 mA max with no load, with a Vcc of 12 to 24 VDC, and at 25°C	
Output Voltage	1 to 5 VDC (non-linear output, load resistance of 10 kΩ)	
Accuracy	±3% FS (25°C characteristic)	
Repeatability (See note 3.)	±0.3% FS	
Output Voltage (Max.)	5.7 VDC (Load resistance: 10 kΩ)	
Output Voltage (Min.)	0 VDC (Load resistance: 10 kΩ)	
Rated Power Supply Voltage	26.4 VDC	
Rated Output Voltage	6 VDC	
Case	PPS	
Degree of Protection	IEC IP40 (Excluding tubing sections.)	
Withstand Pressure	200 kPa	
Pressure Drop (See note 3.)	0.42 kPa	1.06 kPa
Operating Temperature (See note 4.)	-10 to 60°C	
Operating Humidity (See note 4.)	35% to 85%	
Storage Temperature (See note 4.)	-40 to 80°C	
Storage Humidity (See note 4.)	35% to 85%	
Temperature Characteristics	±3% FS for 25°C characteristic at an ambient temperature of -10 to 60°C	
Insulation Resistance	Between Sensor outer cover and lead terminals: 20 MΩ min. (at 500 VDC)	
Dielectric Strength	Between Sensor outer cover and lead terminals: 500 VAC, 50/60 Hz min. for 1 min (leakage current: 1 mA max.)	
Weight	12.8 g	

Note: 1. Volumetric flow rate at 0°C, 101.3 kPa.

Note: 2. Dry gas. (must not contain large particles, e.g., dust, oil, or mist.)

Note: 3. Reference (typical)

Note: 4. With no condensation or icing.

Dimensions (Unit: mm)

D6F-01A1-110 D6F-02A1-110



Mounting Hole Dimensions

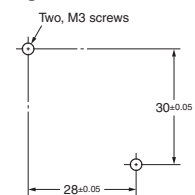

Cable (included): D6F-CABLE1



D6F-N2/-L2

MEMS Flow Sensor

A Compact, High-accuracy Sensor That Measures Low Flow Rates.

Gas Analog

- High accuracy of $\pm 3\%$ FS.
- Flow rates can be measured without being affected by temperature or pressure.



RoHS Compliant



Refer to the *Common Precautions for the D6F Series* on page 40. on page 40.

Ordering Information

MEMS Flow Sensor

Applicable fluid	Flow rate range	Model
Natural gas (13A)	0 to 1 L/min	D6F-01N2-000
	0 to 5 L/min	D6F-05N2-000
LP gas	0 to 2 L/min	D6F-02L2-000

Accessory (included)

Type	Model
Cable	D6F-CABLE1

Connections

D6F-01N2-000

D6F-05N2-000

D6F-02L2-000

Pin No. 1: Vcc
2: Vout
3: GND

Connector 53398-03** (Made by Molex Japan)

Use the following connectors for connections to the D6F:

Housing 51021-0300 (Made by Molex Japan)

Terminals 50079 (Made by Molex Japan)

Wires AWG28 to AWG26

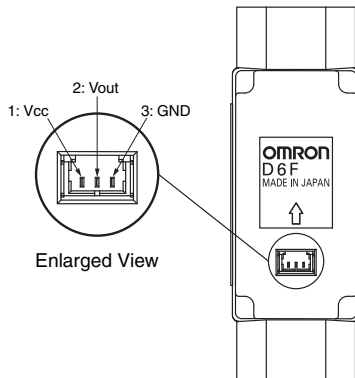

Output Voltage Characteristics

D6F-01N2-000

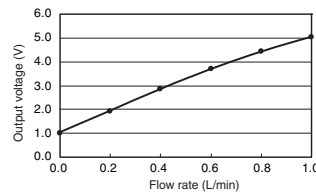

D6F-05N2-000

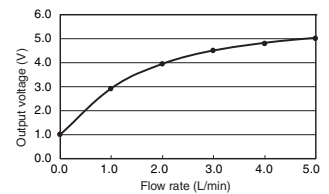

D6F-02L2-000

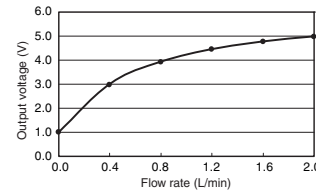

D6F-01N2-000

Flow rate L/min (normal)	0	0.2	0.4	0.6	0.8	1.0
Output voltage V	1.00 ± 0.12	1.90 ± 0.12	2.81 ± 0.12	3.64 ± 0.12	4.37 ± 0.12	5.00 ± 0.12

D6F-05N2-000

Flow rate L/min (normal)	0	1.0	2.0	3.0	4.0	5.0
Output voltage V	1.00 ± 0.12	2.91 ± 0.12	3.92 ± 0.12	4.47 ± 0.12	4.79 ± 0.12	5.00 ± 0.12

D6F-02L2-000

Flow rate L/min (normal)	0	0.4	0.8	1.2	1.6	2.0
Output voltage V	1.00 ± 0.30	3.02 ± 0.08	3.95 ± 0.08	4.47 ± 0.08	4.79 ± 0.08	5.00 ± 0.12

Measurement conditions: Power supply voltage of 12 ± 0.1 VDC, ambient temperature of $25 \pm 5^\circ\text{C}$, and ambient humidity of 35% to 75%.

Characteristics/Performance

Model	D6F-01N2-000	D6F-05N2-000	D6F-02L2-000
Flow Range (See note 1.)	0 to 1 L/min	0 to 5 L/min	0 to 2 L/min.
Calibration Gas (See note 2.)	Natural gas (13A)		Propane gas
Flow Port Type	Rc 1/4 thread		
Electrical Connection	Three-pin connector		
Power Supply	10.8 to 26.4 VDC		
Current Consumption	15 mA max. with no load, with a Vcc of 12 to 24 VDC, and at 25°C		
Output Voltage	1 to 5 VDC (non-linear output, load resistance of 10 kΩ)		
Accuracy	±3% FS (25°C characteristic)	±2% to ±7.5% F.S. (25°C characteristic)	
Repeatability (See note 3.)	±0.2% FS	±0.3% FS	
Output Voltage (Max.)	5.7 VDC (Load resistance: 10 kΩ)		
Output Voltage (Min.)	0 VDC (Load resistance: 10 kΩ)		
Rated Power Supply Voltage	26.4 VDC		
Rated Output Voltage	6 VDC		
Case	Aluminum alloy		
Degree of Protection	IEC IP40 (Excluding tubing sections.)		
Withstand Pressure	200 kPa		
Pressure Drop (See note 3.)	0.017 kPa	0.10 kPa	0.14 kPa
Operating Temperature (See note 4.)	-10 to 60°C		
Operating Humidity (See note 4.)	35% to 85%		
Storage Temperature (See note 4.)	-40 to 80°C		
Storage Humidity (See note 4.)	35% to 85%		
Temperature Characteristics	±3% FS for 25°C characteristic at -10 to 60°C	±4% FS for 25°C characteristic at -10 to 60°C	
Insulation Resistance	Between Sensor outer cover and lead terminals: 20 MΩ min. (at 500 VDC)		
Dielectric Strength	Between Sensor outer cover and lead terminals: 500 VAC, 50/60 Hz min. for 1 min (leakage current: 1 mA max.)		
Weight	35.3 g		

Note: 1. Volumetric flow rate at 0°C, 101.3 kPa.

Note: 2. Dry gas. (must not contain large particles, e.g., dust, oil, or mist.)

Note: 3. Reference (typical)

Note: 4. With no condensation or icing.

Dimensions (Unit: mm)

D6F-01N2-000

D6F-05N2-000

D6F-02L2-000

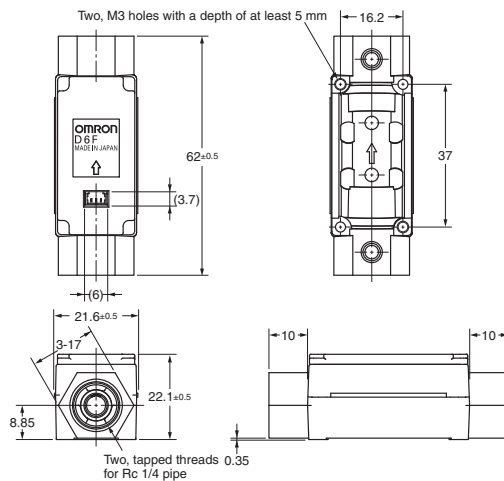

Mounting Hole Dimensions

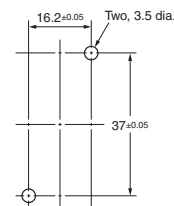

Cable (included): D6F-CABLE1

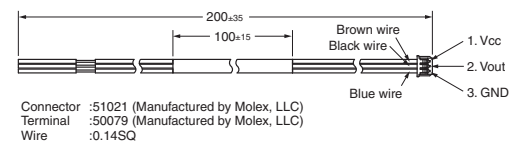

D6F-A3

MEMS Flow Sensor

High-accuracy Sensing with a Thin, Compact Body.

Air Analog

- A thin, lightweight flow sensor.
- Unique flow path structure provides high precision and fast response.



RoHS Compliant



Refer to the *Common Precautions for the D6F Series* on page 40.

Ordering Information

MEMS Flow Sensor

Applicable fluid	Flow rate range	Model
Air	0 to 3 L/min	D6F-03A3-000

Accessory (Sold separately)

Type	Model
Cable	D6F-CABLE2
	D6F-CABLE2-L

Note: Refer to *Accessories for the D6F Series* on page 39.

Connections

D6F-03A3-000



Pin No. 1: GND
 2: Vout
 3: Vcc

Connector SM03B-SRSS-TB (Made by J.S.T. Mfg. Co.)

Use the following connectors made by J.S.T. Mfg. Co. for connections to the Sensor:

- Pressure-welded Connector
 Socket: 03SR-3S
 Wires: AWG30
- Or
- Crimp Connector
 Contacts: SSH-003T-P0.2
 Housing: SHR-03V-S or SHR-03V-S-B
 Wires: AWG32 to AWG28

Output Voltage Characteristics

D6F-03A3-000

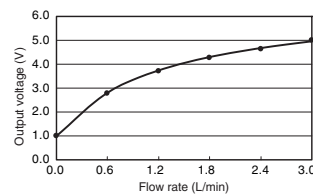

D6F-03A3-000

Flow rate L/min (normal)	0	0.6	1.2	1.8	2.4	3.0
Output voltage V	1.00 ±0.2	2.83 ±0.2	3.77 ±0.2	4.34 ±0.2	4.72 ±0.2	5.00 ±0.2

Measurement conditions: Power supply voltage of 12 ± 0.1 VDC, ambient temperature of 25 ± 5 °C, and ambient humidity of 35% to 75%.

Characteristics/Performance

Model	D6F-03A3-000
Flow Range (See note 1.)	0 to 3 L/min
Calibration Gas (See note 2.)	Air
Flow Port Type	M5 thread
Electrical Connection	Three-pin connector
Power Supply	10.8 to 26.4 VDC
Current Consumption	15 mA max. with no load, with a Vcc of 12 to 24 VDC, and at 25°C
Output Voltage	1 to 5 VDC (non-linear output, load resistance of 10 kΩ)
Accuracy	±5% FS (25°C characteristic)
Repeatability (See note 3.)	±0.7% FS
Output Voltage (Max.)	5.7 VDC (Load resistance: 10 kΩ)
Output Voltage (Min.)	0 VDC (Load resistance: 10 kΩ)
Rated Power Supply Voltage	26.4 VDC
Rated Output Voltage	6 VDC
Case	PPS
Degree of Protection	IEC IP40 (Excluding tubing sections.)
Withstand Pressure	200 kPa
Pressure Drop (See note 3.)	0.45 kPa
Operating Temperature (See note 4.)	0 to 50°C
Operating Humidity (See note 4.)	35% to 85%
Storage Temperature (See note 4.)	-10 to 60°C
Storage Humidity (See note 4.)	35% to 85%
Temperature Characteristics	±5% FS for 25°C characteristic at an ambient temperature of 0 to 50°C
Insulation Resistance	Between Sensor outer cover and lead terminals: 20 MΩ min. (at 500 VDC)
Dielectric Strength	Between Sensor outer cover and lead terminals: 500 VAC, 50/60 Hz min. for 1 min (leakage current: 1 mA max.)
Weight	5.3 g

Note: 1. Volumetric flow rate at 0°C, 101.3 kPa.

Note: 2. Dry gas. (must not contain large particles, e.g., dust, oil, or mist.)

Note: 3. Reference (typical)

Note: 4. With no condensation or icing.

Dimensions (Unit: mm)

● MEMS Flow Sensors

D6F-03A3-000



D6F-A5

MEMS Flow Sensor

High-accuracy Sensing with a Compact Body for Flow Rates Up to 50 L/min.

Air Analog

- Accurately detects a mass flow rate of 10 to 50 L/min.
- A compact size of 30 × 78 × 30 mm (H × W × D).



RoHS Compliant



Refer to the *Common Precautions for the D6F Series* on page 40.

Ordering Information

MEMS Flow Sensor

Flow Port Type	Applicable fluid	Flow rate range	Model
Manifold	Air	0 to 10 L/min	D6F-10A5-000
		0 to 20 L/min	D6F-20A5-000
		0 to 50 L/min	D6F-50A5-000

Accessory (Sold separately)

Type	Model
Cable	D6F-CABLE1

Note: Refer to *Accessories for the D6F Series* on page 39.

Connections

D6F-10A5-000
D6F-20A5-000
D6F-50A5-000

Pin No. 1: Vcc
2: Vout
3: GND
Connector 53398-03** (Made by Molex Japan)

Use the following connectors for connections to the D6F:
Housing 51021-0300 (Made by Molex Japan)
Terminals 50079 (Made by Molex Japan)
Wires AWG28 to AWG26

1: Vcc 2: Vout 3: GND



Enlarged View



Output Voltage Characteristics

D6F-10A5-000



D6F-20A5-000

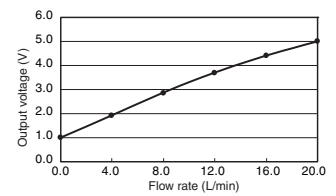

D6F-50A5-000



D6F-10A5-000

Flow rate L/min (normal)	0	2.0	4.0	6.0	8.0	10.0
Output voltage V	1.00	1.75	2.60	3.45	4.25	5.00
	±0.12	±0.12	±0.12	±0.12	±0.12	±0.12

D6F-20A5-000

Flow rate L/min (normal)	0	4.0	8.0	12.0	16.0	20.0
Output voltage V	1.00	1.93	2.87	3.70	4.41	5.00
	±0.12	±0.12	±0.12	±0.12	±0.12	±0.12

D6F-50A5-000

Flow rate L/min (normal)	0	10	20	30	40	50
Output voltage V	1.00	2.45	3.51	4.20	4.66	5.00
	±0.12	±0.12	±0.12	±0.12	±0.12	±0.12

Measurement conditions: Power supply voltage of 12±0.1 VDC, ambient temperature of 25±5°C, and ambient humidity of 35% to 75%.

Characteristics/Performance

Model	D6F-10A5-000	D6F-20A5-000	D6F-50A5-000
Flow Range (See note 1.)	0 to 10 L/min	0 to 20 L/min	0 to 50 L/min
Calibration Gas (See note 2.)	Air		
Flow Port Type	Manifold		
Electrical Connection	Three-pin connector		
Power Supply	10.8 to 26.4 VDC		
Current Consumption	15 mA max. with no load, with a Vcc of 12 to 24 VDC, and at 25°C		
Output Voltage	1 to 5 VDC (non-linear output, load resistance of 10 kΩ)		
Accuracy	±3% FS (25°C characteristic)		
Repeatability (See note 3.)	±0.3% FS		
Output Voltage (Max.)	5.7 VDC (Load resistance: 10 kΩ)		
Output Voltage (Min.)	0 VDC (Load resistance: 10 kΩ)		
Rated Power Supply Voltage	26.4 VDC		
Rated Output Voltage	6 VDC		
Case	PPS/aluminum alloy		
Degree of Protection	IEC IP40 (Excluding tubing sections.)		
Withstand Pressure	500 kPa		
Pressure Drop (See note 3.)	0.8 kPa	2.9 kPa	17.2 kPa
Operating Temperature (See note 4.)	-10 to 60°C		
Operating Humidity (See note 4.)	35% to 85%		
Storage Temperature (See note 4.)	-30 to 80°C		
Storage Humidity (See note 4.)	35% to 85%		
Temperature Characteristics	±3% FS for 25°C characteristic at an ambient temperature of -10 to 60°C		
Insulation Resistance	Between Sensor outer cover and lead terminals: 20 MΩ min. (at 500 VDC)		
Dielectric Strength	Between Sensor outer cover and lead terminals: 500 VAC, 50/60 Hz min. for 1 min (leakage current: 1 mA max.)		
Weight	103 g		

Note: 1. Volumetric flow rate at 0°C, 101.3 kPa.

Note: 2. Dry gas. (must not contain large particles, e.g., dust, oil, or mist.)

Note: 3. Reference (typical)

Note: 4. With no condensation or icing.

Dimensions (Unit: mm)

MEMS Flow Sensors

D6F-10A5-000

D6F-20A5-000

D6F-50A5-000

Mounting Hole Dimensions

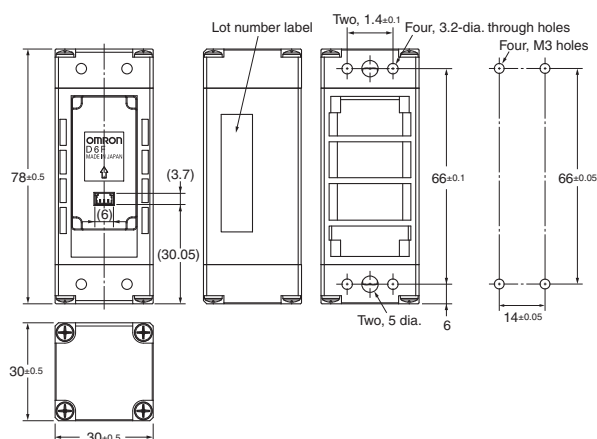

D6F-A6

MEMS Flow Sensor

High-accuracy Sensing with a Compact Body for Flow Rates up to 50 L/min.

▶ Air ▶ Gas ▶ Analog

- Accurately measures an air mass flow rate of 10 to 50 L/min.
- A compact size of 30 × 78 × 30 mm (H × W × D).

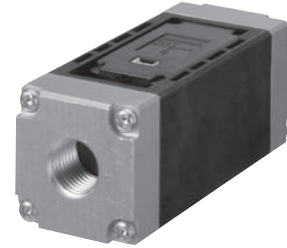

RoHS Compliant



Refer to the *Common Precautions for the D6F Series* on page 40.

Ordering Information

MEMS Flow Sensor

Flow Port Type	Applicable fluid	Flow rate range	Model
Rc 1/4 thread	Air	0 to 10 L/min	D6F-10A6-000
		0 to 20 L/min	D6F-20A6-000
		0 to 50 L/min	D6F-50A6-000
NPT 1/8 thread		0 to 10 L/min	D6F-10A61-000
		0 to 20 L/min	D6F-20A61-000
		0 to 50 L/min	D6F-50A61-000

Accessory (Sold separately)

Type	Model
Cable	D6F-CABLE1

Note: Refer to *Accessories for the D6F Series* on page 39.

Connections

D6F-10A6-000 **D6F-10A61-000**
D6F-20A6-000 **D6F-20A61-000**
D6F-50A6-000 **D6F-50A61-000**

Pin No. 1: Vcc
 2: Vout
 3: GND
 Connector 53398-03** (Made by Molex Japan)

Use the following connectors for connections to the D6F:
 Housing 51021-0300 (Made by Molex Japan)
 Terminals 50079 (Made by Molex Japan)
 Wires AWG28 to AWG26

1: Vcc 2: Vout 3: GND



Output Voltage Characteristics

D6F-10A6-000
D6F-10A61-000

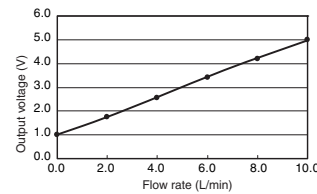

D6F-20A6-000
D6F-20A61-000



D6F-50A6-000
D6F-50A61-000

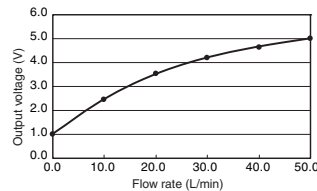

D6F-10A6-000/D6F-10A61-000

Flow rate L/min (normal)	0	2.0	4.0	6.0	8.0	10.0
Output voltage V	1.00 ±0.12	1.75 ±0.12	2.60 ±0.12	3.45 ±0.12	4.25 ±0.12	5.00 ±0.12

D6F-20A6-000/D6F-20A61-000

Flow rate L/min (normal)	0	4	8	12	16	20
Output voltage V	1.00 ±0.12	1.93 ±0.12	2.87 ±0.12	3.70 ±0.12	4.41 ±0.12	5.00 ±0.12

D6F-50A6-000/D6F-50A61-000

Flow rate L/min (normal)	0	10	20	30	40	50
Output voltage V	1.00 ±0.12	2.45 ±0.12	3.51 ±0.12	4.20 ±0.12	4.66 ±0.12	5.00 ±0.12

Measurement conditions: Power supply voltage of 12±0.1 VDC, ambient temperature of 25±5°C, and ambient humidity of 35% to 75%.

Characteristics/Performance

Model	D6F-10A6-000	D6F-20A6-000	D6F-50A6-000	D6F-10A61-000	D6F-20A61-000	D6F-50A61-000
Flow Range (See note 1.)	0 to 10 L/min	0 to 20 L/min	0 to 50 L/min	0 to 10 L/min	0 to 20 L/min	0 to 50 L/min
Calibration Gas (See note 2.)	Air					
Flow Port Type	Rc 1/4 thread			NPT 1/8 thread		
Electrical Connection	Three-pin connector					
Power Supply	10.8 to 26.4 VDC					
Current Consumption	15 mA max. with no load, with a Vcc of 12 to 24 VDC, and at 25°C					
Output Voltage	1 to 5 VDC (non-linear output, load resistance of 10kΩ min.)					
Accuracy	±3% FS (25°C characteristic)					
Repeatability (See note 3.)	±0.3% FS					
Output Voltage (Max.)	5.7 VDC (Load resistance: 10 kΩ)					
Output Voltage (Min.)	0 VDC (Load resistance: 10 kΩ)					
Rated Power Supply Voltage	26.4 VDC					
Rated Output Voltage	6 VDC					
Case	PPS/aluminum alloy					
Degree of Protection	IEC IP40 (Excluding tubing sections.)					
Withstand Pressure	500 kPa					
Pressure Drop (See note 3.)	0.10 kPa	0.28 kPa	1.44 kPa	0.15 kPa	0.52 kPa	2.31 kPa
Operating Temperature (See note 4.)	-10 to 60°C					
Operating Humidity (See note 4.)	35% to 85%					
Storage Temperature (See note 4.)	-30 to 80°C					
Storage Humidity (See note 4.)	35% to 85%					
Temperature Characteristics	±3% FS for 25°C characteristic at an ambient temperature of -10 to 60°C					
Insulation Resistance	Between Sensor outer cover and lead terminals: 20 MΩ min. (at 500 VDC)					
Dielectric Strength	Between Sensor outer cover and lead terminals: 500 VAC, 50/60 Hz min. for 1 min (leakage current: 1 mA max.)					
Weight	103 g					

Note: 1. Volumetric flow rate at 0°C, 101.3 kPa.

Note: 2. Dry gas. (must not contain large particles, e.g., dust, oil, or mist.)

Note: 3. Reference (typical)

Note: 4. With no condensation or icing.

Dimensions (Unit: mm)

MEMS Flow Sensors

Mounting Hole Dimensions

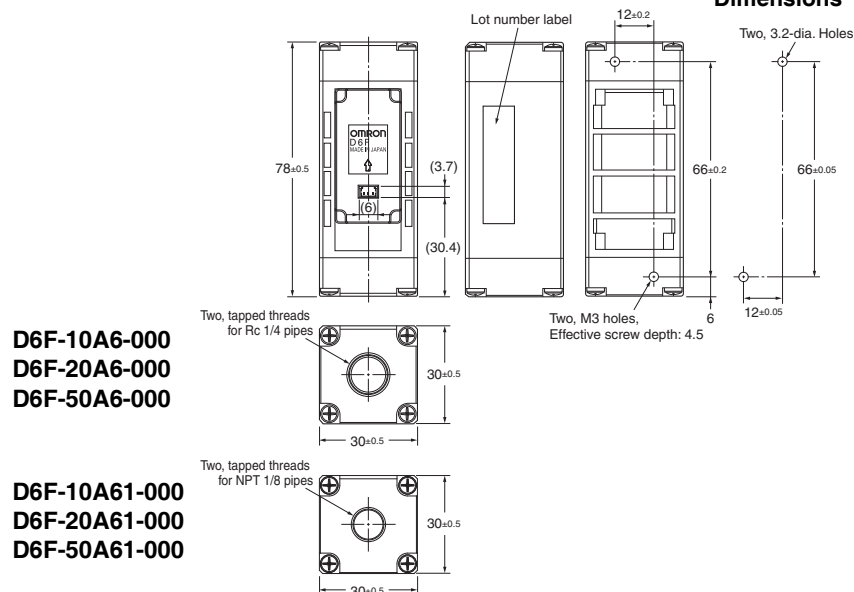

D6F-A7/-L7/-N7

MEMS Flow Sensor

Reduction of Piping time by quick joint connection

Air Gas Analog

- Low-flow rate of natural gas and LP gas can be measured.
- 10 L/min and 30 L/min of Air can be measured.
- Compact size of 30 × 84.6 × 30 mm (H × W × D).



RoHS Compliant



Refer to the *Common Precautions for the D6F Series* on page 40.

Ordering Information

MEMS Flow Sensor

Flow Port Type	Applicable fluid	Flow rate range	Model
Quick joint P10	Natural gas (13A)	0 to 5 L/min	D6F-05N7-000
	LP gas	0 to 2 L/min	D6F-02L7-000
	Air	0 to 10 L/min	D6F-10A7-000
		0 to 30 L/min	D6F-30A7-000

Accessories (Sold separately)

Type	Model
Cable	D6F-CABLE1
Quick fastener	D6F-FASTENER-P10
Pipe fittings	D6F-PLG1

Note: Refer to *Accessories for the D6F Series* on page 39.

Connections

D6F-05N7-000 D6F-02L7-000
D6F-10A7-000 D6F-30A7-000

Pin No. 1: Vcc
2: Vout
3: GND
Connector 53398-03** (Made by Molex Japan)

Use the following connectors for connections to the D6F:
Housing 51021-0300 (Made by Molex Japan)
Terminals 50079 (Made by Molex Japan)
Wires AWG28 to AWG26

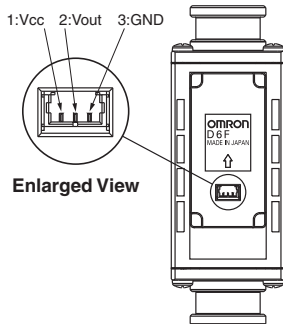

Output Voltage Characteristics

D6F-05N7-000

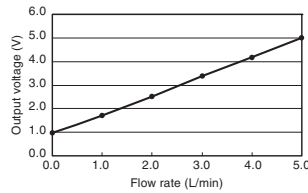

D6F-02L7-000

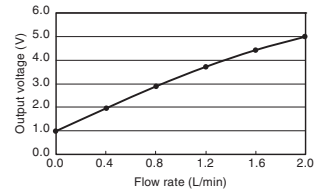

D6F-10A7-000

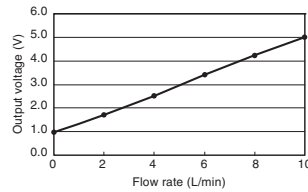

D6F-30A7-000

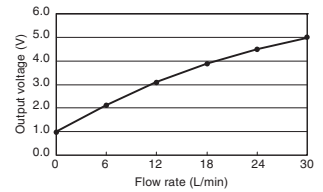

D6F-05N7-000

Flow rate L/min (normal)	0	1.0	2.0	3.0	4.0	5.0
Output voltage V	1.00	1.68	2.47	3.31	4.15	5.00
	±0.12	±0.12	±0.12	±0.12	±0.12	±0.12

D6F-02L7-000

Flow rate L/min (normal)	0	0.4	0.8	1.2	1.6	2.0
Output voltage V	1.00	1.96	2.89	3.72	4.43	5.00
	±0.12	±0.12	±0.12	±0.12	±0.12	±0.12

D6F-10A7-000

Flow rate L/min (normal)	0	2.0	4.0	6.0	8.0	10.0
Output voltage V	1.00	1.75	2.60	3.45	4.25	5.00
	±0.12	±0.12	±0.12	±0.12	±0.12	±0.12

D6F-30A7-000

Flow rate L/min (normal)	0	6	12	18	24	30
Output voltage V	1.00	2.11	3.12	3.91	4.53	5.00
	±0.12	±0.12	±0.12	±0.12	±0.12	±0.12

Measurement conditions: Power-supply voltage 12±0.1 VDC, ambient temperature 25±5°C and ambient humidity 35 to 75%RH.

Characteristics/Performance

Model	D6F-05N7-000	D6F-02L7-000	D6F-10A7-000	D6F-30A7-000
Flow Range (See note 1.)	0 to 5 L/min	0 to 2 L/min	0 to 10 L/min	0 to 30 L/min
Calibration Gas (See note 2.)	Natural gas (13A)	LP gas	Air	
Flow Port Type	Quick joint P10			
Electrical Connection	Three-pin connector			
Power Supply	10.8 to 26.4 VDC			
Current Consumption	15 mA max. with no load and Vcc of 12 to 24 VDC, GND = 0 VDC, 25°C			
Output Voltage	1 to 5 VDC (non-linear output, load resistance of 10 kΩ min.)			
Accuracy	±3%F.S. (25°C characteristic)			
Repeatability (See note 3.)	±0.3%F.S.			
Output Voltage (Max.)	5.7 VDC (Load resistance: 10 kΩ)			
Output Voltage (Min.)	0 VDC (Load resistance: 10 kΩ)			
Rated Power Supply Voltage	26.4 VDC			
Rated Output Voltage	6 VDC			
Case	PPS			
Degree of Protection	IEC IP40 (Excluding tubing sections.)			
Withstand Pressure	500 kPa			
Pressure Drop (See note 3.)	0.06 kPa	0.03 kPa	0.32 kPa	2.19 kPa
Operating Temperature (See note 4.)	-10 to +60°C			
Operating Humidity (See note 4.)	35 to 85%RH			
Storage Temperature (See note 4.)	-10 to +80°C		-30 to +80°C	
Storage Humidity (See note 4.)	35 to 85%RH			
Temperature Characteristics	±3%F.S. for 25°C characteristic at an ambient temperature of -10 to +60°C			
Insulation Resistance	Between sensor outer cover and lead terminals: 20 MΩ min. (at 500 VDC)			
Dielectric Strength	Between sensor outer cover and lead terminals: 500 VAC, 50/60 Hz min. for 1 min (leakage current: 1 mA max.)			
Weight	72 g			

Note: 1. Volumetric flow rate at 0°C, 101.3 kPa.

Note: 2. Dry gas (must not contain large particles, e.g., dust, oil, or mist.)

Note: 3. Reference (typical)

Note: 4. With no condensation or icing.

Dimensions (Unit: mm)

MEMS Flow Sensors

D6F-05N7-000

D6F-02L7-000

D6F-10A7-000

D6F-30A7-000

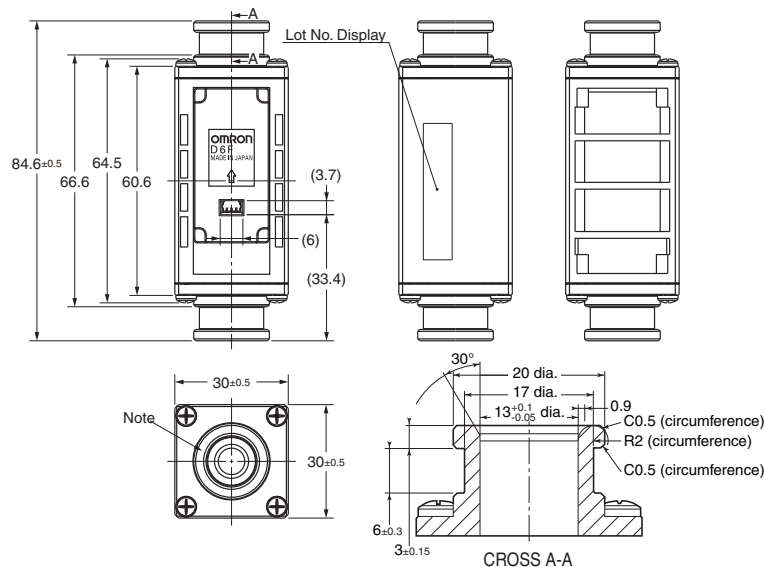

Recommended Quick joint male P10 type

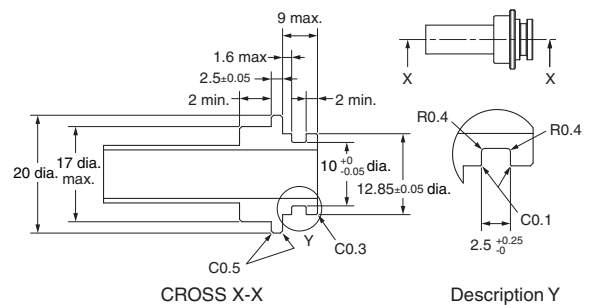

If using a Rc3/8 converter joint, the following is recommended.
 REGAL JOINT CO., LTD eigyou@rjl.co.jp
 Converter male joint (Rc3/8-Quick male joint): Adapter Rc3/8-QJM10
 O ring: O ring P10 fluororubber (material)

Note. The Port type of pipe fitting based on "Quick Joint P10 Type".

* P10 shows the name of an O-ring prescribed by JIS B 2401.

* The port of O-ring ditch is based on P10 of JIS B 2406.

* Please obtain a male joint separately.

D6F-A7D/-AB71D

MEMS Flow Sensor

Digital Compensation for High Accuracy

- Temperature compensation and linear compensation produce high accuracy ($\pm 3\%$ RD (25% to 100% FS)).
- Compact models for 10 to 70 L/min.
- Reduced piping work with quick-fastening feature.



NEW

RoHS Compliant



Refer to the *Common Precautions for the D6F Series* on page 40.

Ordering Information

MEMS Flow Sensor

Joint	Applicable fluid	Flow rate range	Model
Quick joint P10	Air	0 to 10 L/min	D6F-10A7D-000-0
		0 to 20 L/min	D6F-20A7D-000-0
		0 to 50 L/min	D6F-50A7D-000-0
Quick joint P14		0 to 70 L/min	D6F-70AB71D-000-0

Accessories (Sold separately)

Type	Model
Cable	D6F-CABLE3
Quick fastener	D6F-FASTENER-P10
Pipe fittings	D6F-PLG1

Note: Refer to *Accessories for the D6F Series* on page 39.

Connections

D6F-10A7D-000-0

D6F-20A7D-000-0

D6F-50A7D-000-0

D6F-70AB71D-000-0

Pin No. 1: Vcc
2: SDA
3: SCL
4: GND

Connector BM04B-GHS (made by J.S.T. Mfg. Co.)

Use the following connectors for connections to the D6F:
Housing GHR-04V-S (made by J.S.T. Mfg. Co.)
Terminals SSSL-002T-P0.2 (made by J.S.T. Mfg. Co.)
Wires AWG26 to AWG30

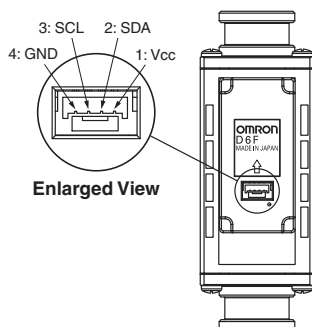

Output Characteristics

D6F-10A7D-000-0

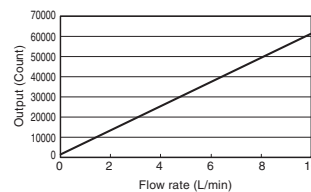

D6F-20A7D-000-0

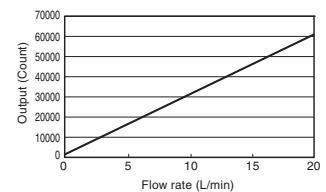

D6F-50A7D-000-0

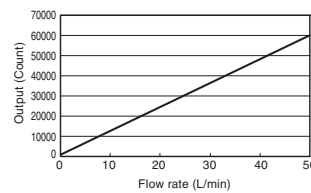

D6F-70AB71D-000-0

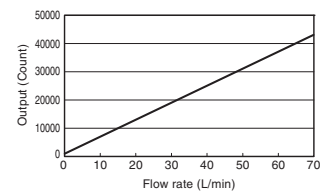

D6F-10A7D-000-0

Flow rate L/min (normal)	0	2	4	6	8	10
Output (HEX)	1024 (0400)	13024 (32E0)	25024 (61C0)	37024 (90A0)	49024 (BF80)	61024 (EE60)

Measurement conditions: Power-supply voltage 3.3 ± 0.1 VDC, ambient temperature $25 \pm 5^\circ\text{C}$ and ambient humidity 35 to 75%RH.
Flow rate = (Output value - 1,024)/60,000 x 10

D6F-20A7D-000-0

Flow rate L/min (normal)	0	4	8	12	16	20
Output (HEX)	1024 (0400)	13024 (32E0)	25024 (61C0)	37024 (90A0)	49024 (BF80)	61024 (EE60)

Measurement conditions: Power-supply voltage 3.3 ± 0.1 VDC, ambient temperature $25 \pm 5^\circ\text{C}$ and ambient humidity 35 to 75%RH.
Flow rate = (Output value - 1,024)/60,000 x 20

D6F-50A7D-000-0

Flow rate L/min (normal)	0	10	20	30	40	50
Output (HEX)	1024 (0400)	13024 (32E0)	25024 (61C0)	37024 (90A0)	49024 (BF80)	61024 (EE60)

Measurement conditions: Power-supply voltage 3.3 ± 0.1 VDC, ambient temperature $25 \pm 5^\circ\text{C}$ and ambient humidity 35 to 75%RH.
Flow rate = (Output value - 1,024)/60,000 x 50

D6F-70AB71D-000-0

Flow rate L/min (normal)	0	20	40	60	70
Output (HEX)	1024 (0400)	13024 (32E0)	25024 (61C0)	37024 (90A0)	43024 (A810)

Measurement conditions: Power-supply voltage 3.3 ± 0.1 VDC, ambient temperature $25 \pm 5^\circ\text{C}$ and ambient humidity 35 to 75%RH.
Flow rate = (Output value - 1,024)/60,000 x 100

Characteristics/Performance

Model	D6F-10A7D-000-0	D6F-20A7D-000-0	D6F-50A7D-000-0	D6F-70AB71D-000-0
Flow Range (See note 1.)	0 to 10L/min	0 to 20 L/min	0 to 50 L/min	0 to 70 L/min
Calibration Gas (See note 2.)	Air			
Flow Port Type	Quick joint P10			Quick joint P14
Electrical Connection	Four-pin connector			
Power Supply	3.0 to 3.6 VDC			
Current Consumption	10 mA max. with no load, Vcc = 3.3 VDC, GND = 0 VDC, 25°C			
Resolution	15 bit			
Accuracy (See note 3.)	±5%RD (10%F.S. ≤ Flow rate < 25%F.S.) ±3%RD (25%F.S. ≤ Flow rate ≤ 100%F.S.)			±5%RD (10L/min ≤ Flow rate < 20L/min) ±3%RD (20L/min ≤ Flow rate ≤ 70L/min)
Response time	90 ms max.			
Repeatability (See note 4.)	0.3 %RD	0.3%RD	0.5%RD	1.3%RD
Interface (See note 5.)	I2C			
Case	PPS			
Degree of Protection	IEC IP40 (Excluding tubing sections.)			
Withstand Pressure	100 kPa			
Pressure Drop (See note 4.)	0.034 kPa	0.083 kPa	0.28 kPa	0.57 kPa
Operating Temperature (See note 6.)	-10 to +60°C			
Operating Humidity (See note 6.)	35 to 85%RH			
Storage Temperature (See note 6.)	-30 to +80°C			
Storage Humidity (See note 6.)	35 to 85%RH			
Insulation Resistance	Between sensor outer cover and lead terminals: 20 MΩ min. (at 500 VDC)			
Dielectric Strength	Between sensor outer cover and lead terminals: 500 VAC, 50/60 Hz min. for 1 min (leakage current: 1 mA max.)			
Weight	57.3 g			64.4 g

Note: 1. Volumetric flow rate at 0°C, 101.3 kPa.

Note: 2. Dry gas (must not contain large particles, e.g., dust, oil, or mist.)

Note: 3. -10 ≤ Operating Temperature ≤ 60°C

Note: 4. Reference (typical)

Note: 5. Refer to the D6F-□□□□D-000-□ Application Notes for details.

Note: 6. With no condensation or icing.

Note: 7. The following custom options are available.

Ask your OMRON representative for details.

- Temperature measurement
- Address settings (up to four addresses)
- Fault detection
- Threshold setting

Communication

Serial Interface	I2C
Master/Slave	Slave / Address: HEX : 0x6C BIN : 110_1100 (7bit)
Speed mode	Fast Mode 400kHz
Signal	
SCL	Serial Clock
SDA	Data Signal

Dimensions (Unit: mm)

MEMS Flow Sensors

D6F-10A7D-000-0

D6F-20A7D-000-0

D6F-50A7D-000-0



Recommended Quick joint male P10 type

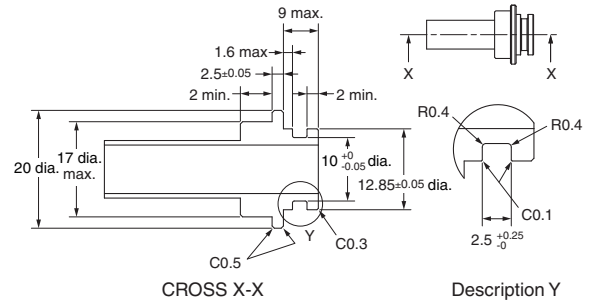

If using a Rc3/8 converter joint, the following is recommended.

REGAL JOINT CO., LTD eigyou@rgl.co.jp

Converter male joint (Rc3/8-Quick male joint): Adapter Rc3/8-QJM10
O ring: O ring P10 fluororubber (material)

Note 1. Note . The Port type of pipe fitting based on "Quick Joint P10 Type".

* P10 shows the name of an O-ring prescribed by JIS B 2401.

* The port of O-ring ditch is based on P10 of JIS B 2406.

* Please obtain a male joint separately.

Note 2. Use the following connectors to connect to the Sensor.

Connector :GHR-04V-S (JST)

Terminals :SSHL-002T-P0.2 (JST)

Wires :AWG26 to AWG30

Circuit numbers :1.Vcc, 2.SDA, 3.SCL, 4.GND

D6F-70AB71D-000-0

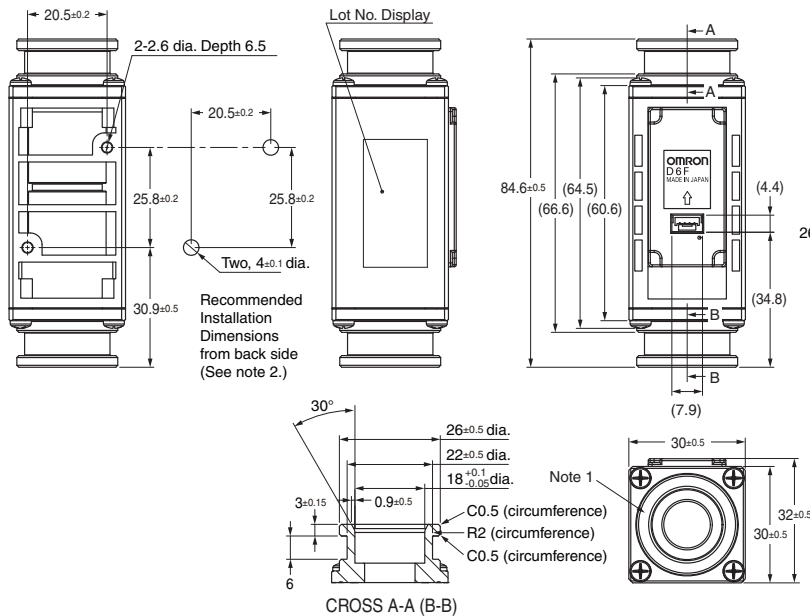

Recommended Quick joint male P14 type

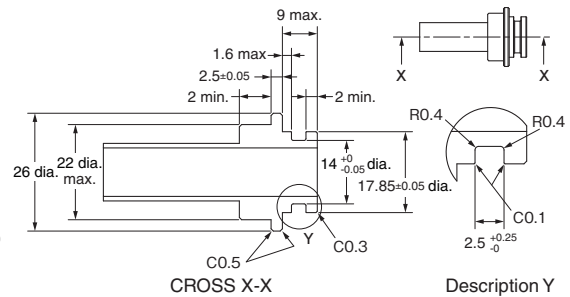

If using a Rc3/8 converter joint, the following is recommended.

REGAL JOINT CO., LTD eigyou@rgl.co.jp

Converter male joint (Rc3/8-Quick male joint): Adapter Rc3/8-QJM14
O ring: O ring P14 fluororubber (material)

Note 1. The Port type of pipe fitting based on "Quick Joint P14 Type".

* P14 shows the name of an O-ring prescribed by JIS B 2401.

* The port of O-ring ditch is based on P14 of JIS B 2406.

* Please obtain a male joint separately.

Note 2. To mount the Sensor with 2.6-dia. holes, use P-type self-tapping screws with a nominal diameter of 3 mm and tighten them to a torque of 1.2 N-m max.

The screw threads must engage for 5.5 mm min.

Note 3. Use the following connectors to connect to the Sensor.

Connector :GHR-04V-S (JST)

Terminals :SSHL-002T-P0.2 (JST)

Wires :AWG26 to AWG30

Circuit numbers :1.Vcc, 2.SDA, 3.SCL, 4.GND

D6F-AB71

MEMS Flow Sensor

Reduction of Piping time by quick joint connection

Air Analog

- Reduce the influence of pulsation flow by bypass flow path
- 30 L/min and 70 L/min of Air can be measured.
- Compact size of 30 × 84.6 × 32 mm (H × W × D).



RoHS Compliant



Refer to the *Common Precautions for the D6F Series* on page 40.

Ordering Information

MEMS Flow Sensor

Flow Port Type	Applicable fluid	Flow rate range	Model
Quick joint P14	Air	0 to 30 L/min	D6F-30AB71-000
		0 to 70 L/min	D6F-70AB71-000

Accessory (Sold separately)

Type	Model
Cable	D6F-CABLE1

Note: Refer to *Accessories for the D6F Series* on page 39.

Connections

D6F-30AB71-000 D6F-70AB71-000

Pin No.	1: Vcc
	2: Vout
	3: GND
Connector	53398-03** (Made by Molex Japan)

Use the following connectors for connections to the D6F:

Housing	51021-0300 (Made by Molex Japan)
Terminals	50079 (Made by Molex Japan)
Wires	AWG28 to AWG26

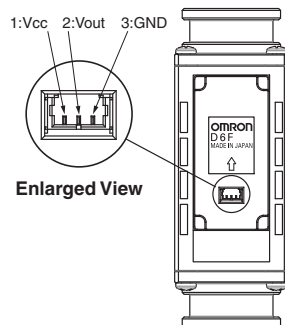

Output Voltage Characteristics

D6F-30AB71-000

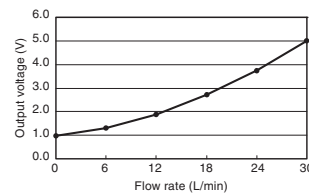

D6F-70AB71-000

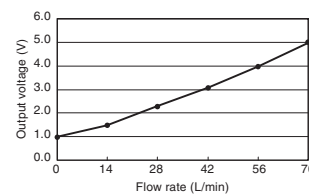

D6F-30AB71-000

Flow rate L/min (normal)	0	6	12	18	24	30
Output voltage V	1.00	1.25	1.91	2.75	3.78	5.00
	±0.12	±0.12	±0.12	±0.12	±0.12	±0.12

D6F-70AB71-000

Flow rate L/min (normal)	0	14	28	42	56	70
Output voltage V	1.00	1.43	2.25	3.14	4.06	5.00
	±0.12	±0.12	±0.12	±0.12	±0.12	±0.12

Measurement conditions: Power-supply voltage 12±0.1 VDC, ambient temperature 25±5°C and ambient humidity 35 to 75%RH.

Characteristics/Performance

Model	D6F-30AB71-000	D6F-70AB71-000
Flow Range (See note 1.)	0 to 30 L/min	0 to 70 L/min
Calibration Gas (See note 2.)	Air	
Flow Port Type	Quick joint P14	
Electrical Connection	Three-pin connector	
Power Supply	10.8 to 26.4 VDC	
Current Consumption	15 mA max. with no load and Vcc of 12 to 24 VDC, GND = 0 VDC, 25°C	
Output Voltage	1 to 5 VDC (non-linear output, load resistance of 10 kΩ min.)	
Accuracy	±3%F.S. (25°C characteristic)	
Repeatability (See note 3.)	±0.3%F.S.	
Output Voltage (Max.)	5.7 VDC (Load resistance: 10 kΩ)	
Output Voltage (Min.)	0 VDC (Load resistance: 10 kΩ)	
Rated Power Supply Voltage	26.4 VDC	
Rated Output Voltage	6 VDC	
Case	PPS	
Degree of Protection	IEC IP40 (Excluding tubing sections.)	
Withstand Pressure	100 kPa	
Pressure Drop (See note 3.)	0.88 kPa	3.49 kPa
Operating Temperature (See note 4.)	-10 to +60°C	
Operating Humidity (See note 4.)	35 to 85%RH	
Storage Temperature (See note 4.)	-30 to +80°C	
Storage Humidity (See note 4.)	35 to 85%RH	
Temperature Characteristics	±3%F.S. for 25°C characteristic at an ambient temperature of -10 to +60°C	
Insulation Resistance	Between sensor outer cover and lead terminals: 20 MΩ min. (at 500 VDC)	
Dielectric Strength	Between sensor outer cover and lead terminals: 500 VAC, 50/60 Hz min. for 1 min (leakage current: 1 mA max.)	
Weight	75 g	

Note 1. Volumetric flow rate at 0°C, 101.3 kPa.

Note 2. Dry gas (must not contain large particles, e.g., dust, oil, or mist.)

Note 3. Reference (typical)

Note 4. With no condensation or icing.

Dimensions (Unit: mm)

MEMS Flow Sensors

D6F-30AB71-000

D6F-70AB71-000

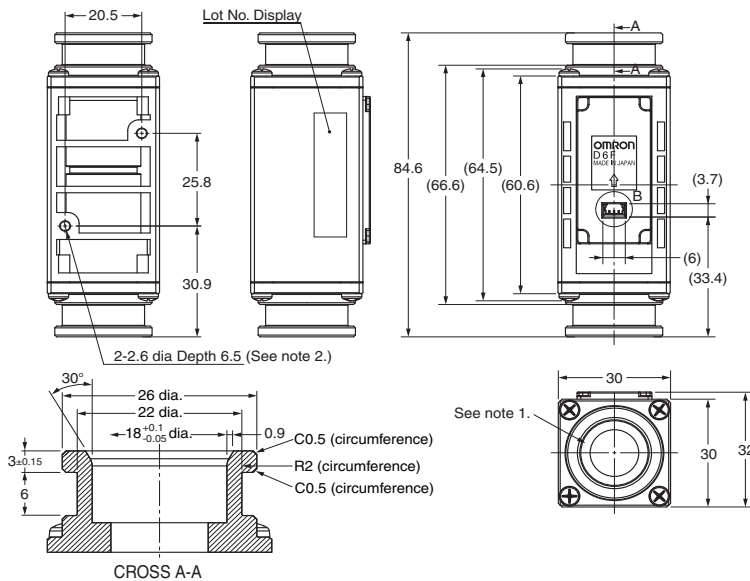

Recommended Quick joint male P14 type

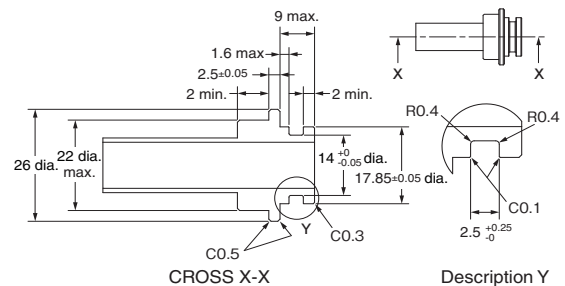

CROSS X-X

Description Y

If using a Rc3/8 converter joint, the following is recommended.
 REGAL JOINT CO., LTD eigyou@rjl.co.jp
 Converter male joint (Rc3/8-Quick male joint): Adapter Rc3/8-QJM14
 O ring: O ring P14 fluororubber (material)

- Note 1. The flow path inlet and outlet ports conform to P14-type female quick-connect joints.
 (The tube inlet and outlet ports have the same shape.)
 * P14 is the number of an O-ring specified in JIS B 2401.
 * The O-ring groove in the male joint must conform to P14 in JIS B 2406.
 * Please obtain a male joint separately.
- Note 2. To mount the Sensor with 2.6-dia. holes, use P-type self-tapping screws with a nominal diameter of 3 mm and tighten them to a torque of 1.2 N·m max. The screw threads must engage for 5.5 mm min.
- Note 3. Use the following connectors to connect to the Sensor.
 Connector : GHR-04V-S (JST)
 Terminals : SSLH-002T-P0.2 (JST)
 Wires : AWG26 to AWG30
 Circuit numbers : 1. Vcc, 2. SDA, 3. SCL, and 4. GND.

D6F-P

MEMS Flow Sensor

▶ Air ▶ Analog

A Compact, High-accuracy Flow Sensor with Superior Resistance to Environments.

- Anti-dust performance is improved using the Cyclon method.
- A full lineup of models with different connector types: bamboo joints, lead terminals for direct mounting on-board, and manifolds.
- High accuracy of $\pm 5\%$ FS.

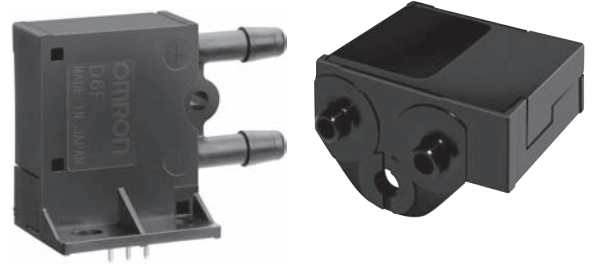

RoHS Compliant



Refer to the *Common Precautions for the D6F Series* on page 40.

Ordering Information

MEMS Flow Sensor

Flow Port Type	Connection	Applicable fluid	Flow rate range	Model
Bamboo joint	Lead terminals	Air	0 to 0.1 L/min	D6F-P0001A1
			0 to 1 L/min	D6F-P0010A1
Manifold	Connector		0 to 1 L/min	D6F-P0010A2
				D6F-P0010AM2

Accessory (Sold separately)

Type	Model
Cable	D6F-CABLE2
	D6F-CABLE2-L

Note: Refer to *Accessories for the D6F Series* on page 39.

Output Voltage Characteristics

D6F-P0001A1

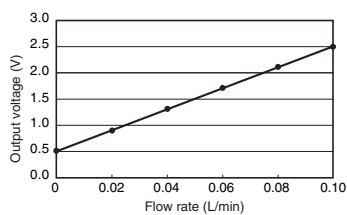

Flow rate L/min (normal)	0	0.02	0.04	0.06	0.08	0.10
Output voltage V	0.50	0.90	1.30	1.70	2.10	2.50
	± 0.10	± 0.10	± 0.10	± 0.10	± 0.10	± 0.10

Measurement conditions: Power supply voltage of 5.0 ± 0.1 VDC, ambient temperature of $25 \pm 5^\circ\text{C}$, and ambient humidity of 35% to 75%.

D6F-P0010A1/-P0010A2/-P0010AM2

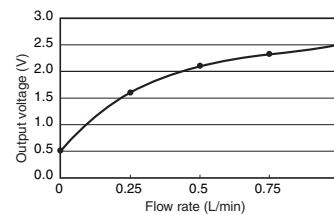

Flow rate L/min (normal)	0	0.25	0.50	0.75	1.00
Output voltage V	0.50	1.60	2.10	2.31	2.50
	± 0.10	± 0.10	± 0.10	± 0.10	± 0.10

Measurement conditions: Power supply voltage of 5.0 ± 0.1 VDC, ambient temperature of $25 \pm 5^\circ\text{C}$, and ambient humidity of 35% to 75%.

Characteristics/Performance

Model	D6F-P0001A1	D6F-P0010A1	D6F-P0010A2	D6F-P0010AM2
Flow Range (See note 1.)	0 to 0.1 L/min	0 to 1 L/min		
Calibration Gas (See note 2.)	Air			
Flow Port Type	Bamboo joint Maximum outside diameter: 4.9 mm, minimum outside diameter: 4.0 mm			Manifold
Electrical Connection	Lead terminals		Three-pin connector	
Power Supply	4.75 to 5.25 VDC			
Current Consumption	15 mA max. with no load and a Vcc of 5.0 V			
Output Voltage	0.5 to 2.5 VDC (Load resistance: 10 kΩ)			
Accuracy	±5% FS (25°C characteristic)			
Repeatability (See note 3.)	±1.0% FS	±0.4% FS		
Output Voltage (Max.)	3.1 VDC (Load resistance: 10 kΩ)			
Output Voltage (Min.)	0 VDC (Load resistance: 10 kΩ)			
Rated Power Supply Voltage	10 VDC			
Rated Output Voltage	4 VDC			
Case	PBT			
Degree of Protection	IEC IP40 (Excluding tubing sections.)			
Withstand Pressure (See note 3.)	50 kPa			
Pressure Drop (See note 3.)	0.005 kPa	0.19 kPa		0.67 kPa
Operating Temperature (See note 4.)	-10 to +60°C			
Operating Humidity (See note 4.)	35% to 85%			
Storage Temperature (See note 4.)	-40 to +80°C			
Storage Humidity (See note 4.)	35% to 85%			
Temperature Characteristics	±5% FS for 25°C characteristic at an ambient temperature of -10 to +60°C			
Insulation Resistance	Between Sensor outer cover and lead terminals: 20 MΩ min. (at 500 VDC)			
Dielectric Strength	Between Sensor outer cover and lead terminals: 500 VAC, 50/60 Hz min. for 1 min (leakage current: 1 mA max.)			
Weight	8.5 g			8.0 g

Note: 1. Volumetric flow rate at 0°C, 101.3 kPa.

Note: 2. Dry gas. (must not contain large particles, e.g., dust, oil, or mist.)

Note: 3. Reference (typical)

Note: 4. With no condensation or icing.

Tubing

You can measure large flows by mounting the Sensor on a bypass.

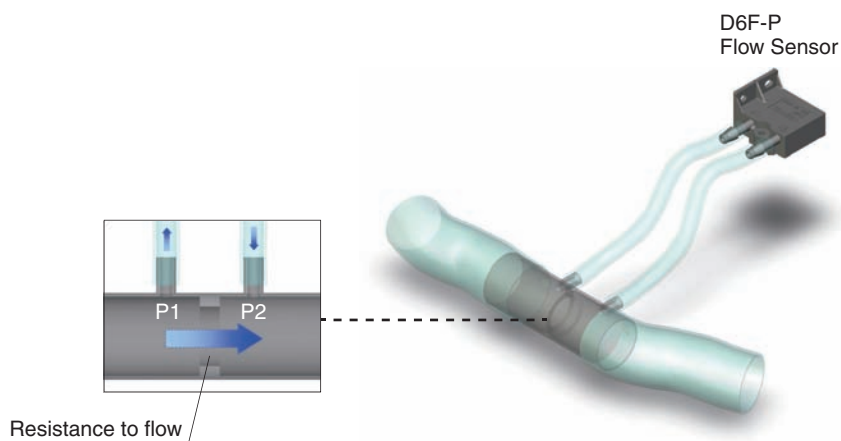

Mounting Direction Bamboo joint Sensor



Manifold-type Sensor



Connections/Dimensions (Unit: mm)

● Lead Terminals

D6F-P0001A1/D6F-P0010A1

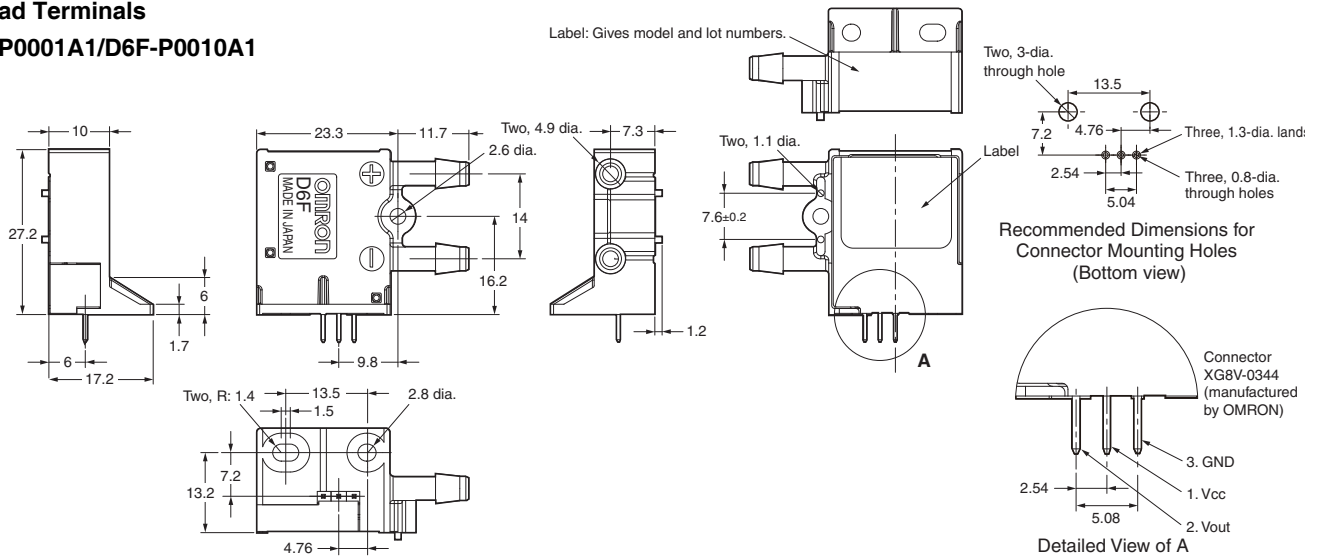

● Connectors

D6F-P0010A2

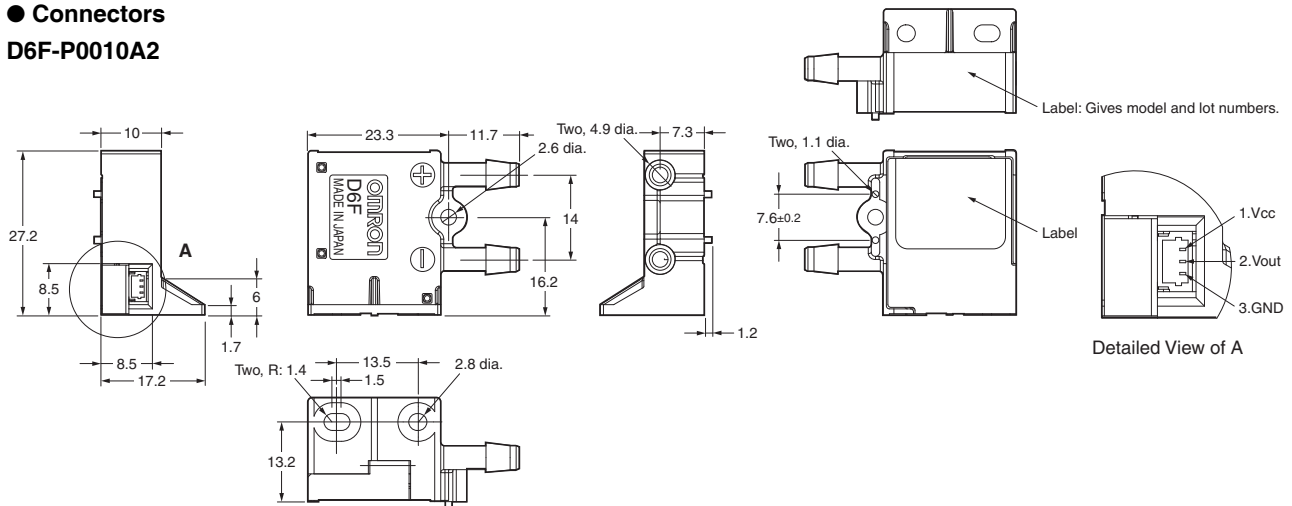

D6F-P0010AM2

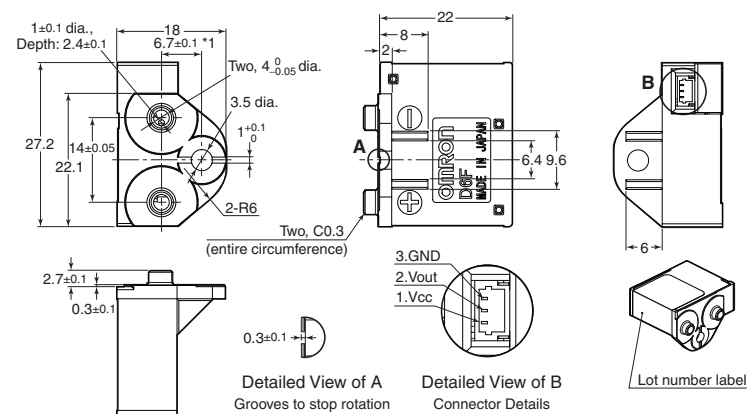

*1. Recommended Installation Dimensions

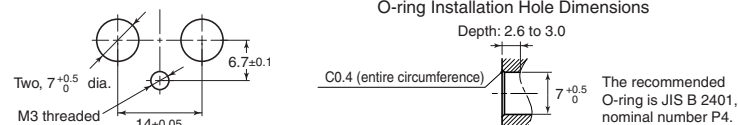

Pin No. 1: Vcc
2: Vout
3: GND

Connector SM03B-SRSS-TB (made by J.S.T. Mfg. Co.)

Note: Use one of the following connectors from JST Mfg. Co., Ltd. to connect to the D6F.

- 1) Pressure welding connector
Socket: 03SR-3S
Wire: AWG#30
Or
- 2) Crimp type connector
Contact: SSH-003T-P0.2
Housing: SHR-03V-S
Wire: AWG#32 to #28

Tubes

Install tubes made of materials such as rubber or urethane so that they will not come out.

For urethane tubes, tubes with an outer diameter of 6 mm and an inner diameter of 4 mm are recommended.

Soldering Conditions

Use a soldering iron for 5 s at 350°C with a pressure of 100 gf max.

(This applies only to PCB-mounting Sensors.)

D6F-PH

MEMS Differential pressure Sensor

A Compact, High-accuracy Differential Pressure Sensor with Superior Resistance to Environments.

 Air  Digital

- High accuracy of $\pm 3\%$ RD
- Linearized and temperature compensated
- Digital output (I2C communication)
- High flow impedance to reduce the influence of bypass configuration
- Lineup of 4 types of slave address models



RoHS Compliant



Refer to the *Common Precautions for the D6F Series* on page 40.

Ordering Information

Applicable fluid (See note 1.)	Measurement range (See note 3.)	slave address (7 bit)	Model
Air (See note 2.)	0 to 250 Pa	0b110_1100, 0x6C	D6F-PH0025AD1
		0b110_1101, 0x6D	D6F-PH0025AD1-1
		0b110_1110, 0x6E	D6F-PH0025AD1-2
		0b110_1111, 0x6F	D6F-PH0025AD1-3
	-50 to 50 Pa	0b110_1100, 0x6C	D6F-PH0505AD3
		0b110_1101, 0x6D	D6F-PH0505AD3-1
		0b110_1110, 0x6E	D6F-PH0505AD3-2
		0b110_1111, 0x6F	D6F-PH0505AD3-3
	-500 to 500 Pa	0b110_1100, 0x6C	D6F-PH5050AD3
		0b110_1101, 0x6D	D6F-PH5050AD3-1
		0b110_1110, 0x6E	D6F-PH5050AD3-2
		0b110_1111, 0x6F	D6F-PH5050AD3-3

Note: 1. The Sensor be calibrated for different gas types. Consult your Omron representative.

Note: 2. Dry gas must not contain large particles, e.g., dust, oil, or mist.

Note: 3. At standard atmospheric pressure (1013.25 hPa)

Output Characteristics

D6F-PH0025AD1-□

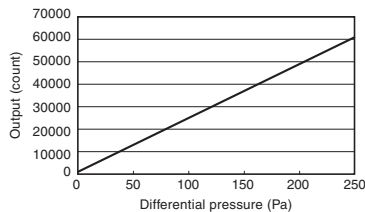

Differential pressure (Pa)	0	50	100	150	200	250
Output (HEX)	1024 (0400)	13024 (32E0)	25024 (61C0)	37024 (90A0)	49024 (BF80)	61024 (EE60)

Measurement conditions: Power supply voltage of 3.3 ± 0.1 VDC, ambient temperature of $25 \pm 5^\circ\text{C}$, and ambient humidity of 35% to 75%.

Differential pressure conversion formula: $Dp = (Op - 1024) / 60000 \times 250$

Dp = Differential pressure, Op = Output

D6F-PH0505AD3-□

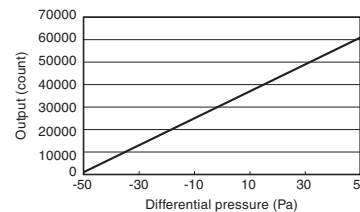

Differential pressure (Pa)	-50	-30	-10	0	10	30	50
Output (HEX)	1024 (0400)	13024 (32E0)	25024 (61C0)	31024 (7930)	37024 (90A0)	49024 (BF80)	61024 (EE60)

Measurement conditions: Power supply voltage of 3.3 ± 0.1 VDC, ambient temperature of $25 \pm 5^\circ\text{C}$, and ambient humidity of 35% to 75%.

Differential pressure conversion formula: $Dp = (Op - 1024) / 60000 \times 100 - 50$

Dp = Differential pressure, Op = Output

D6F-PH5050AD3-□

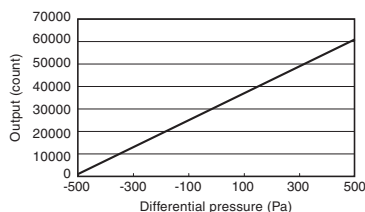

Differential pressure (Pa)	-500	-300	-100	0	100	300	500
Output (HEX)	1024 (0400)	13024 (32E0)	25024 (61C0)	31024 (7930)	37024 (90A0)	49024 (BF80)	61024 (EE60)

Measurement conditions: Power supply voltage of 3.3 ± 0.1 VDC, ambient temperature of $25 \pm 5^\circ\text{C}$, and ambient humidity of 35% to 75%.

Differential pressure conversion formula: $Dp = (Op - 1024) / 60000 \times 1000 - 500$

Dp = Differential pressure, Op = Output

Note. Change of gas density affects the sensor output.
Change of atmospheric pressure is compensated by the following formula.
 $Dpeff = Dp \times (Pstd / Pamb)$
 $Dpeff$: Effective differential pressure
 Dp : Differential pressure of the sensor output
 $Pstd$: Standard atmospheric pressure (1013.25 hPa)
 $Pamb$: Actual ambient atmospheric pressure (hPa)

Characteristics/Performance

Model	D6F-PH0025AD1-□	D6F-PH0505AD3-□	D6F-PH5050AD3-□
Differential pressure range (See note 1)	0 to 250 Pa	±50 Pa	±500 Pa
Calibration Gas (See note 2.)	Air		
Port Type	Bamboo joint, Maximum outside diameter: 4.9 mm, minimum outside diameter: 4.0 mm		
Power Supply	2.3 to 3.6 VDC		
Current Consumption	6 mA max. with no load and Vcc of 3.3 VDC, GND = 0 VDC, 25°C		
Resolution	12 bit		
Zero point tolerance (See note 3.)	±0.2 Pa		
Span tolerance (See note 3.)	±3% RD		
Span shift due to temperature variation	< 0.5% RD per 10°C		
Response time	33 ms typical at 12 bit resolution (50 ms max.) The processing time is 6 ms typical at 12 bit resolution.		
Gas flow through sensor (See note 5.)	63 mL/min	23 mL/min	100 mL/min
Interface	I2C		
Case material	PPS		
Degree of Protection	IEC IP40 (Excluding tubing sections.)		
Withstand Pressure	10 kPa		
Operating temperature (See note 4.)	-20 to +80°C		
Operating humidity (See note 4.)	35 to 85 %RH		
Storage temperature (See note 4.)	-40 to +80°C		
Storage humidity (See note 4.)	35 to 85 %RH		
Insulation Resistance	Between Sensor outer cover and lead terminals: 20 MΩ min. (at 500 VDC)		
Dielectric Strength	Between Sensor outer cover and lead terminals: 500 VAC, 50/60 Hz min. for 1 min (leakage current: 1 mA max.)		
Weight	5.2 g		

Note: 1. At standard atmospheric pressure (1013.25 hPa)

Note: 2. Dry gas must not contain large particles, e.g., dust, oil, or mist.

Note: 3. The zero point tolerance and span tolerance are independent uncertainties and add according to the principles of error propagation.

Note: 4. With no condensation or icing.

Note: 5. Type D6F-PH is based on thermal flow principle. Air flow is needed to measure the differential pressure.

Typical characteristic of air flow by differential pressure is below.

Relation between pressure and flow rate

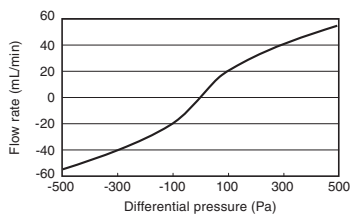

Connections/Dimensions (Unit: mm)



Mounting Direction
Install the Sensor so that the joints are facing upward.

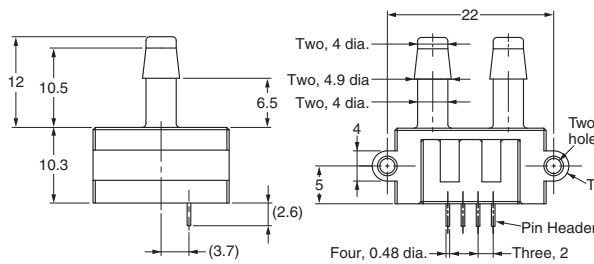

Recommendation size for pin header installation (tolerances: ± 0.1)

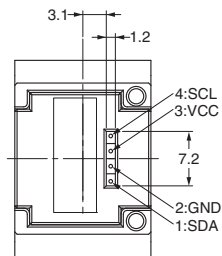
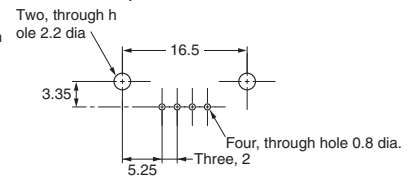

Tubes

Install tubes made of materials such as rubber, urethane or nylon so that they will not come out. For urethane tubes, tubes with an outer diameter of 6 mm and an inner diameter of 4 mm are recommended.

Soldering Conditions

Use a soldering iron for 5 s at 350°C with a pressure of 100 gf max.

Electrical connection

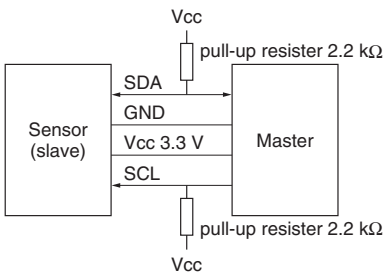

Communication

		D6F-PH0025AD1 D6F-PH0505AD3 D6F-PH5050AD3	D6F-PH0025AD1-1 D6F-PH0505AD3-1 D6F-PH5050AD3-1	D6F-PH0025AD1-2 D6F-PH0505AD3-2 D6F-PH5050AD3-2	D6F-PH0025AD1-3 D6F-PH0505AD3-3 D6F-PH5050AD3-3
Serial Interface		I2C			
Master/Slave	HEX	0x6C	0x6D	0x6E	0x6F
	BIN (7bit)	0b110_1100	0b110_1101	0b110_1110	0b110_1111
Speed mode		Max. 400kHz (Fast Mode)			
Signal	SCL	Serial Clock			
	SDA	Data Signal			

D6F-W

MEMS Flow Sensor

A Compact Sensor That Uses OMRON's Unique Flow Path Structure for High-performance Flow Rate Measurement.

➤ Air ➤ Analog

- Anti-dust performance enhanced by OMRON's unique three-dimensional flow path structure.
- High accuracy of $\pm 5\%$ FS.

RoHS Compliant



Refer to the *Common Precautions for the D6F Series* on page 40.



Ordering Information

MEMS Flow Sensor

Applicable fluid	Flow rate range	Model
Air	0 to 1 m/s	D6F-W01A1
	0 to 4 m/s	D6F-W04A1
	0 to 10 m/s	D6F-W10A1

Accessory (Sold separately)

Type	Model
Cable	D6F-W CABLE
	D6F-W CABLE-L

Note: Refer to *Accessories for the D6F Series* on page 39.

Connections

D6F-W01A1
D6F-W04A1
D6F-W10A1

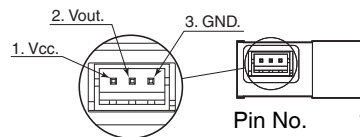

Enlarged View

Pin No. 1: Vcc
2: Vout
3: GND
Connector S3B-ZR-SM2-TF
(made by J.S.T. Mfg. Co.)

Use the following connectors from J.S.T. Mfg. Co. Ltd. to connect the D6F:

Housing: ZHR-3

Contacts: SZH-002T-P0.5
Wires: AWG28 to AWG26
Or

Contacts: SZH-003T-P0.5
Wires: AWG32 to AWG28

Output Voltage Characteristics

D6F-W01A1

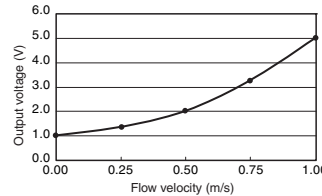

D6F-W04A1

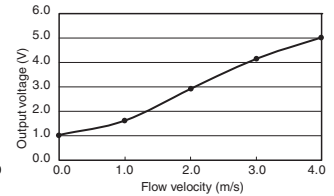

D6F-W10A1

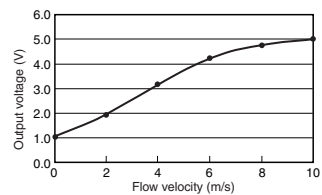

D6F-W01A1

Flow velocity m/s	0	0.25	0.50	0.75	1.00
Output voltage V	1.00 \pm 0.2	1.35 \pm 0.2	2.01 \pm 0.2	3.27 \pm 0.2	5.00 \pm 0.2

D6F-W04A1

Flow velocity m/s	0	1.0	2.0	3.0	4.0
Output voltage V	1.00 \pm 0.2	1.58 \pm 0.2	2.88 \pm 0.2	4.11 \pm 0.2	5.00 \pm 0.2

The flow velocity is the value calculated from the mass flow rate in OMRON's specified 48-mm-dia. wind tunnel. It does not indicate the flow velocity determined by the Measurement Law of Japan. The wind tunnel conditions are shown in *Figure 1*, below.

Figure 1: Wind Tunnel

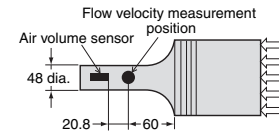

Measurement conditions: Power supply voltage of 12 VDC, ambient temperature of 25°C, and ambient humidity of 35% to 75%.

D6F-W10A1

Flow velocity m/s	0	2.0	4.0	6.0	8.0	10.0
Output voltage V	1.00 \pm 0.24	1.94 \pm 0.24	3.23 \pm 0.24	4.25 \pm 0.24	4.73 \pm 0.24	5.00 \pm 0.24

The flow velocity is the value calculated from the mass flow rate in OMRON's specified 155-mm-dia. wind tunnel. It does not indicate the flow velocity determined by the Measurement Law of Japan. The wind tunnel conditions are shown in *Figure 2*, below.

Figure 2: Wind Tunnel

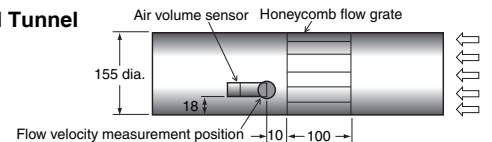

Measurement conditions: Power supply voltage of 12 VDC and ambient temperature of 25°C

Characteristics/Performance

Model	D6F-W01A1	D6F-W04A1	D6F-W10A1
Flow Range (See note 1.)	0 to 1 m/s	0 to 4 m/s	0 to 10 m/s
Calibration Gas (See note 2.)	Air		
Electrical Connection	Three-pin connector		
Power Supply	10.8 to 26.4 VDC		
Current Consumption	15 mA max. with no load, with a Vcc of 12 to 24 VDC, and at 25°C		
Output Voltage	1 to 5 VDC (non-linear output, load resistance of 10 kΩ)		
Accuracy	±5% FS (25°C characteristic)		±6% FS (25°C characteristic)
Repeatability (See note 3.)	±0.4% FS		
Output Voltage (Max.)	5.7 VDC (Load resistance: 10 kΩ)		
Output Voltage (Min.)	0 VDC (Load resistance: 10 kΩ)		
Rated Power Supply Voltage	26.4 VDC		
Rated Output Voltage	6 VDC		
Case	PPS		
Degree of Protection	IEC IP40 (except for flow inlet and outlet)		
Operating Temperature (See note 4.)	-10 to 60°C		
Operating Humidity (See note 4.)	35% to 85%		
Storage Temperature (See note 4.)	-40 to 80°C		
Storage Humidity (See note 4.)	35% to 85%		
Temperature Characteristics	±5% FS for 25°C characteristic at an ambient temperature of -10 to 60°C		
Insulation Resistance	Between Sensor outer cover and lead terminals: 20 MΩ min. (at 500 VDC)		
Dielectric Strength	Between Sensor outer cover and lead terminals: 500 VAC, 50/60 Hz min. for 1 min (leakage current: 1 mA max.)		
Weight	6.3 g		

Note: 1. Volumetric flow rate at 25°C, 101.3 kPa.

Note: 2. Dry gas. (must not contain large particles, e.g., dust, oil, or mist.)

Note: 3. Reference (typical)

Note: 4. With no condensation or icing.

Dimensions (Unit: mm)

MEMS Flow Sensors

D6F-W01A1

D6F-W04A1

D6F-W10A1

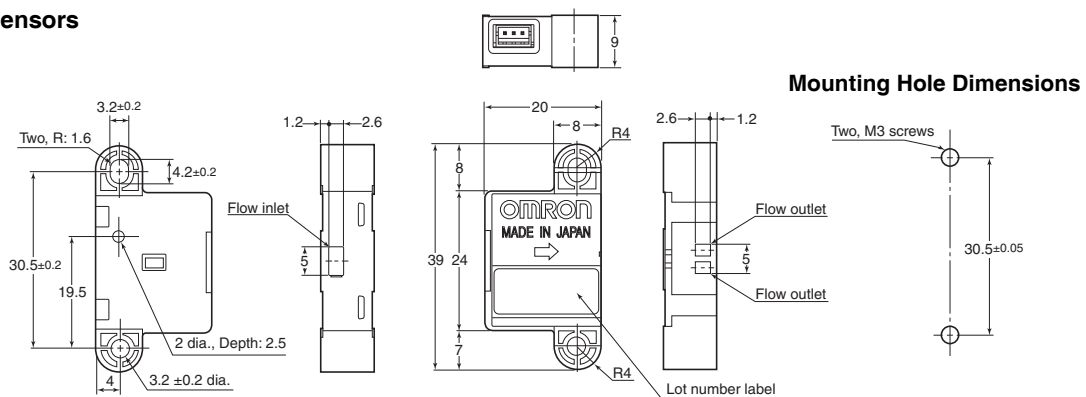

D6F-V

MEMS Flow Sensor

▶ Air ▶ Analog

A Compact Sensor That Uses OMRON's Unique Flow Path Structure for High-performance Flow Rate Measurement.

- Anti-dust performance enhanced by OMRON's unique three-dimensional flow path structure.
- Extremely compact, measuring only 24 × 14 × 8 mm.

RoHS Compliant



Refer to the *Common Precautions for the D6F Series* on page 40.

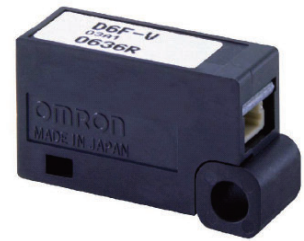

Ordering Information

MEMS Flow Sensor

Applicable fluid	Flow velocity range	Model
Air	0 to 3 m/s	D6F-V03A1

Accessory (Sold separately)

Type	Model
Cable	D6F-CABLE2
	D6F-CABLE2-L

Note: Refer to *Accessories for the D6F Series* on page 39.

Connections

D6F-V03A1

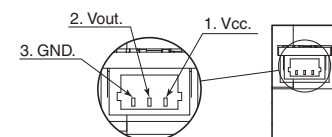

Enlarged View

Pin No. 1: Vcc
2: Vout
3: GND

Connector SM03B-SRSS-TB (made by J.S.T. Mfg. Co.)

Use the following connectors from J.S.T. Mfg. Co. Ltd. to connect the D6F:

- Pressure-welded Connectors
 - Socket: 03SR-3S
 - Wires: AWG30
- Or
- Crimp Connectors
 - Contact: SSH-003T-P0.2
 - Housing: SHR-03V-S
- Wires: AWG32 to AWG28

Output Voltage Characteristics

D6F-V03A1

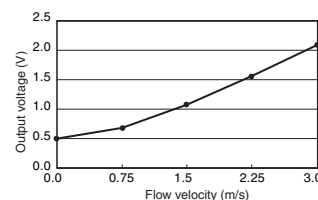

D6F-V03A1

Flow velocity m/s	0	0.75	1.5	2.25	3
Output voltage V	0.5±0.15	0.7±0.15	1.11±0.15	1.58±0.15	2±0.15

The flow velocity is the value calculated from the mass flow rate in OMRON's specified 48-mm-dia. wind tunnel. It does not indicate the flow velocity determined by the Measurement Law of Japan. The wind tunnel conditions are shown in Figure 1 below.

Figure 1: Wind Tunnel

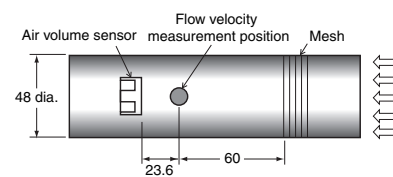

Measurement conditions: Power supply voltage of 3.3 VDC, ambient temperature of 25°C, and dry air.

Characteristics/Performance

Model	D6F-V03A1
Flow Range (See note 1.)	0 to 3 m/s
Calibration Gas (See note 2.)	Air
Electrical Connection	Three-pin connector
Power Supply	3.15 to 3.45 VDC
Current Consumption	15 mA max. with no load, with a Vcc of 3.3 VDC, and at 25°C
Output Voltage	0.5 to 2 VDC (non-linear output, load resistance of 10 kΩ)
Accuracy	±10% FS (25°C characteristic)
Repeatability (See note 3.)	±1.5% FS
Output Voltage (Max.)	2.7 VDC (Load resistance: 10 kΩ)
Output Voltage (Min.)	0 VDC (Load resistance: 10 kΩ)
Rated Power Supply Voltage	12 VDC
Rated Output Voltage	3 VDC
Case	PBT
Degree of Protection	IEC IP40 (except for flow inlet and outlet)
Operating Temperature (See note 4.)	-10 to 60°C
Operating Humidity (See note 4.)	35% to 85%
Storage Temperature (See note 4.)	-40 to 80°C
Storage Humidity (See note 4.)	35% to 85%
Temperature Characteristics	±20% FS for 25°C characteristic at an ambient temperature of -10 to 60°C
Insulation Resistance	Between Sensor outer cover and lead terminals: 20 MΩ min. (at 500 VDC)
Dielectric Strength	Between Sensor outer cover and lead terminals: 500 VAC, 50/60 Hz min. for 1 min (leakage current: 1 mA max.)
Weight	5.3 g

Note: 1. Volumetric flow rate at 25°C, 101.3 kPa.

Note: 2. Dry gas. (must not contain large particles, e.g., dust, oil, or mist.)

Note: 3. Reference (typical)

Note: 4. With no condensation or icing.

Dimensions (Unit: mm)

MEMS Flow Sensors

D6F-V03A1



D6F-D

MEMS 2-Axis Flow Sensor

 Air  Digital

Save energy with airflow sensing. Optimize air conditioning control without sacrificing quality.

- Two-axis sensing to detect not only the airflow speed but also the airflow direction.
- Link up to 32 Sensors to achieve visualization over a wide range.
- Compact package for greater installation flexibility.



RoHS Compliant



Refer to the *Safety Precautions* on page 38 and *Common Precautions for the D6F Series* on page 40.

Ordering Information

Applicable Medium	Flow Range	Model
Air (See note.)	$\pm 1.0\text{m/s}$	D6F-D010A32-00

Note: Dry gas must not contain large particles, eg dust, oil, mist.

Characteristics/Performance

Characteristics

Item	Rating
Power-supply Voltage	4.5 to 5.5 VDC
Storage Temperature	-10 to 55°C (without freezing and condensation)
Operating Temperature	0 to 40°C
Storage Humidity	30 to 85%
Operating Humidity	30 to 80%

Note: With no condensation or icing.

Performance

Item	Characteristic	
Flow Velocity	Range	$\pm 1.0\text{m/s}$ in each axis
	Accuracy	$\pm 3\%$ F.S. in each axis
Flow Direction	Range	0 to 360°
	Accuracy	$\pm 15^\circ$ (at 0.3m/s)

Note: 1. Flow velocity is determined by our standard wind tunnel (300 mm square), and this does not indicate the flow velocity specified in Measurement law. (Fig.1 shows our standard wind tunnel)

Fig. 1. Wind Tunnel



Connection

Fig. 2. Block Diagram



The sensor has two port of RJ-45 connectors (8 pins), and all the pair of each pin is connected internally. These connectors can be used for daisy chain wiring when using multiple devices on the same bus (multi-drop connection).

The standard CAT5e straight LAN cable can be used for the electrical connection.

Interface

Item	Specifications
Interface	RS-485
Wire Connection	Multi-drop connection with daisy chain wiring (32 devices max.)
Communication system	2 wires : Half duplex
Baud rate	9600bps or 38400bps : DIP switch* selectable
Protocol	Modbus-RTU
Transmission code	Binary
Data length	8 bit
Stop bit	1 bit
Parity	None
Response time	250 ms max.
Command interval	10 ms min. (Minimum wait time after receiving the response from the device to the consecutive command transmission)
Slave address	1 to 32 (0x01 to 0x20) : DIP switch* selectable
Termination resistor	Built-in termination resistor : DIP switch* selectable

* The communication settings of this device can be set by DIP switch configuration as shown in Fig. 3. All bits are switched off before shipment.

Fig. 3. DIP Switches

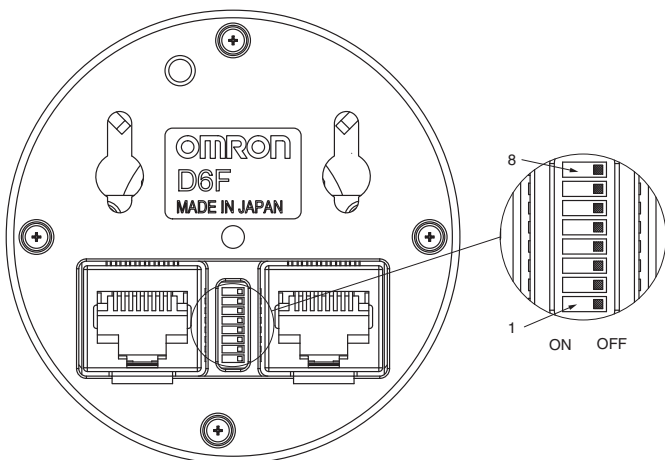

Circuits	Function	ON	OFF
8	Built-in termination resistor	Enable	Disable
7	Baud rate	38400bps	9600bps
6	None	-	-
5	Slave Address : bit 4	1	0
4	Slave Address : bit 3	1	0
3	Slave Address : bit 2	1	0
2	Slave Address : bit 1	1	0
1	Slave Address : bit 0	1	0

Note: Slave address of the device = 1 + (5 bit of integer consisting of circuit number 1 to 5).

Fig. 4. Connection Example to Link Three Sensors

Fig. 4 shows an example of multi-drop connection when connecting three devices on the same bus. In this case, slave address, baud rate and built-in termination resistor of each device must be set properly.

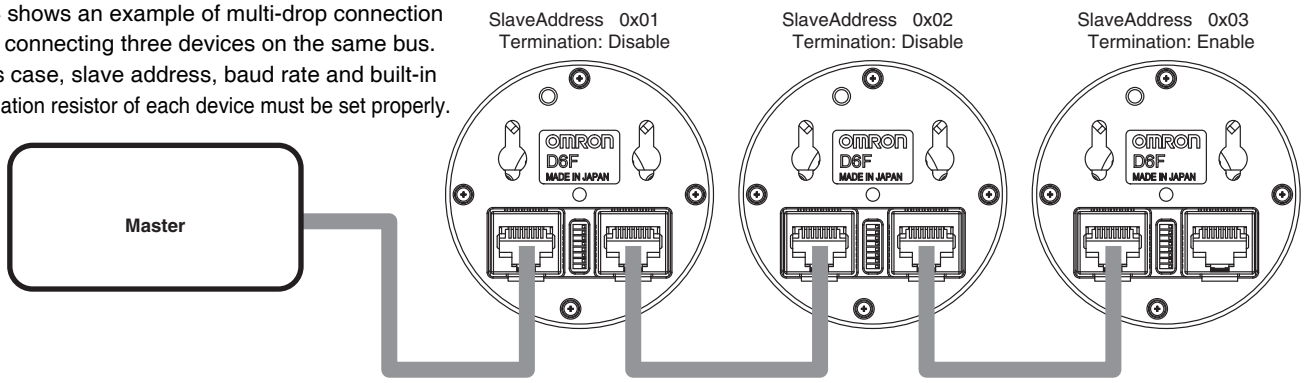

Dimensions (Unit: mm)

D6F-D010A32-00

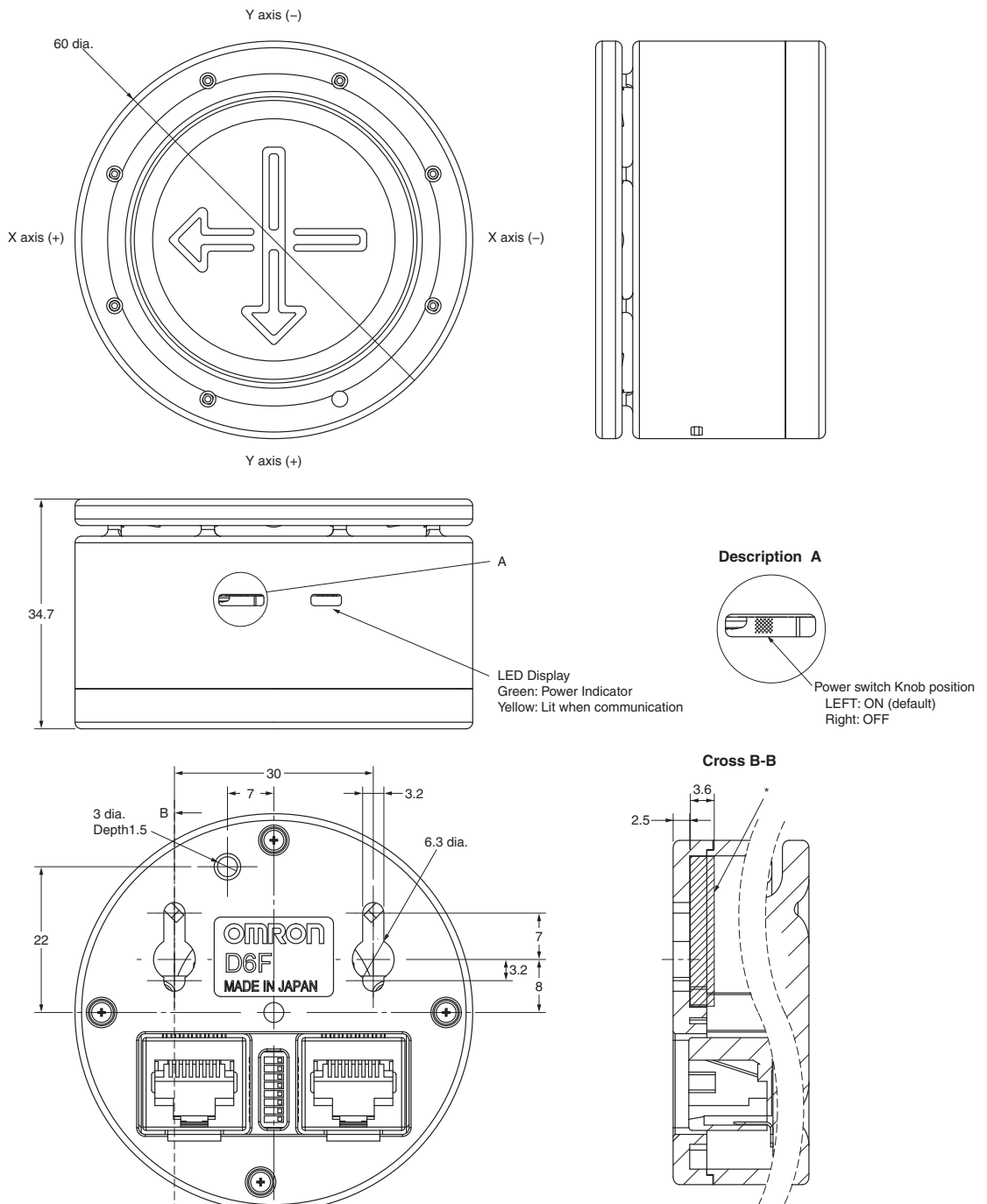

* When using the fixing hole, Please do not exceed the depth (3.6 mm) of the shaded portion.

Safety Precautions

Caution

The sensor is a precision device, and if large shock and load is applied, it may cause a failure or characteristic change. Please do not use the sensor which is added excessive shock to the terminals, discompose the cover, or has fallen.

Precautions for Correct Use

● Applicable medium and Device mounting

- Depending on the mounting position and the ambient environment, the foreign object such as dust can adhere to the inside of the device and can cause clogging of the part of flow path. As a result, the device may not perform as intended. And, the characteristic specified in this document may not be maintained. Please use the device after enough ex-ante evaluation under the condition of actual use in order to confirm the performance and safety in the application.

- For the gasses other than the applicable medium, please use the device in your responsibility after the confirmation of its performance and safety.

However, do not use in the presence of inflammable gases, such as hydrogen, methane, ethane, and a liquefied petroleum gas. In addition, do not use with corrosive gases (such as chlorine, sulfur, acid, alkali, ammonia etc.)

- The direction of the arrow on top of the body shows the positive direction of the device output in each axis. Please install the device in a correct direction corresponding to the direction of the flow. With the wrong installation, the device cannot measure flow direction correctly.
- After installation, the device may not perform as intended by the presence of a flow obstacle around the device.
- After Installation, the device operation and its performance should be checked before actual use in the application.
- Horizontal device orientation (top cover side up) is recommended. If the device orientation is not horizontal, the output may shift as an offset more than $+3\%$ F.S.. For more details of offset compensation features, please refer to the communication specification.
- The device may not operate properly, if a foreign object or a flow obstacle is placed around the entrance of the flow path.

● Use environment

Please do not use the device in the following environments:

- Places where the device directly receives radiant heat from an apparatus.
- Places where the device is exposed to water, salt water, water droplets and oil splash.
- Places where the device is exposed to direct sunlight.
- Places with volatile gas, inflammable gas or corrosive gas (such as chlorine, sulfur, acid, alkali, ammonia etc.)
- Places where frequent temperature changes.
- Places where dusty condition.
- Places with the possibility of freezing and dew condensation.
- Places where the device receives large magnitudes of vibration and shock.

- Places where the device receives strong electric field effect or magnetic field effect.

● Noise Countermeasures

- Please check electrical noise condition before actual use. The device may not perform as intended by the effect from electrical noise.
- The voltage input that exceeds absolute maximum ratings must not be applied. This can damage the electrical circuit of the device. Place the protection circuit as needed, so that the voltage to the lines will not exceed absolute maximum ratings.
- Take particular care to install away from AC power transformers, live mains power lines and high power magnetic circuits.
- The device may not operate properly where the place with the equipment that generates strong high-frequency wave or surge.
- Please attach surge absorber or noise filter to the peripheral equipment that generates noise.
- In order to prevent inductive noise, wiring of the device must be separated from the power line with the high voltage and large current.
- When using with a switching regulator or DC-DC convertor, switching noise may affect the device operation.

● Handling

- Please handle with countermeasure against static electricity.
- Do not make a direct solder connection to the integral terminals; this may result in damage, and possibly cause failure. It is recommended to use the standard straight CAT5e LAN cable and to ensure correct connection.
- Do not mix up the wiring. This can damage the device and cause the failure.
- Power must be supplied from the single source. And, do not apply different voltage to the device from each connector. This may damage the device and also the host equipment (master).
- After wiring cables, please do not apply excessive pulling force to the connector. Tensile force of 12N or more can cause the failure.
- Changing DIP switch setting must be done when in power off state.

● Communication

- When using the multiple devices on the same bus, please make sure that there is no device that has the same slave address, please refer to the communication specification (No.MDPE-12-0146).
- When using built-in termination resistor, please enable it only to one device at the end of the bus.
- Please make sure that there are no multiple devices with termination resistors enabled.
- Please make sure that baud rate setting must be same for the host equipment (master) on the same bus.

Accessories for the D6F Series

Dimensions (Unit: mm)

● Cable (Sold separately)

D6F-CABLE1

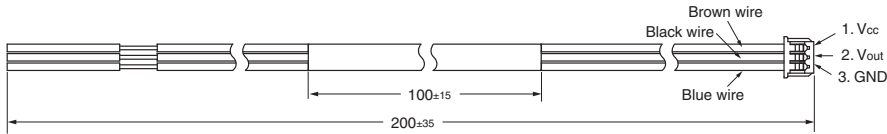

Connector :51021 (Manufactured by Molex, LLC)
Terminal :50079 (Manufactured by Molex, LLC)
Wire :.014SQ

D6F-CABLE2



Contact :SSH-003T-P0.2 (Manufactured by J.S.T. Mfg. Co., Ltd.)
Housing :SHR-03V-S (Manufactured by J.S.T. Mfg. Co., Ltd.)
Wire :AWG#30

D6F-CABLE2-L

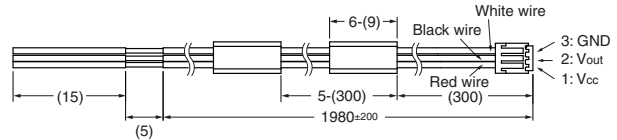

Contact :SSH-003T-P0.2 (Manufactured by J.S.T. Mfg. Co., Ltd.)
Housing :SHR-03V-S (Manufactured by J.S.T. Mfg. Co., Ltd.)
Wire :AWG#30

D6F-CABLE3

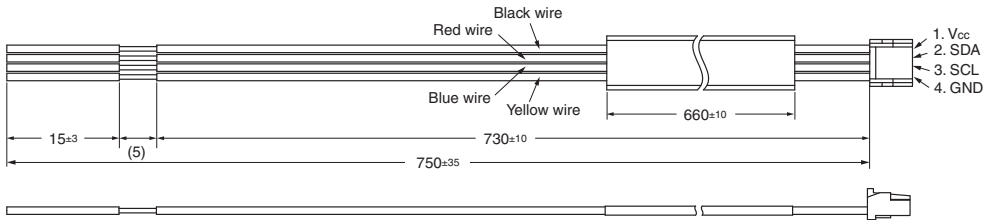

Contact :SSHL-002T-P0.2 (Manufactured by J.S.T. Mfg. Co., Ltd.)
Housing :GHR-04V-S (Manufactured by J.S.T. Mfg. Co., Ltd.)
Wire :AWG#28

D6F-W CABLE



Contact :SZH-002T-P0.5 (Manufactured by J.S.T. Mfg. Co., Ltd.)
Housing :ZHR-3 (Manufactured by J.S.T. Mfg. Co., Ltd.)
Wire :AWG#26

D6F-W CABLE-L

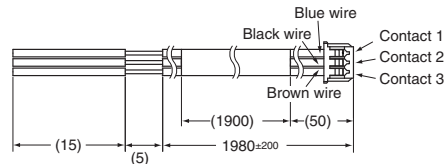

Contact :SZH-002T-P0.5 (Manufactured by J.S.T. Mfg. Co., Ltd.)
Housing :ZHR-3 (Manufactured by J.S.T. Mfg. Co., Ltd.)
Wire :AWG#26

● Quick fastener (Sold separately)

D6F-FASTENER-P10

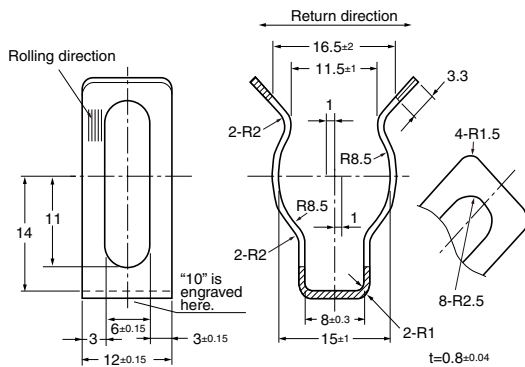

● Pipe fittings (Sold separately)

D6F-PLG1

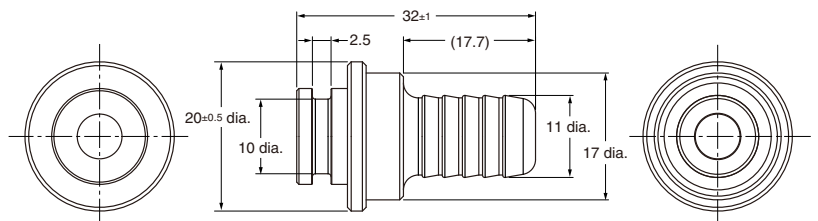

Common Precautions for the D6F Series

Safety Precautions

Precautions for Correct Use

● Sensor Applications

The D6F is built for use with general-purpose devices. In particular, when using the D6F for applications with the safety requirements described below, take steps to ensure system and device safety through measures such as fail-safe designs, redundant designs, and regular inspections.

- Safety devices for ensuring safety for persons
- Transportation equipment control (such as applications to stop operation)
- Aviation and space equipment
- Nuclear power equipment

Do not use the D6F for applications in which D6F operation would directly affect human life.

● Fluids, Pipe Mounting and Sensor Installation

All D6F Models

- (1) Use clean fluids. Install a filter or mist separator on the inflow pipe. Failure to do so may result in malfunction or changes in characteristics due to dust or mist. This does not apply to the D6F-W, D6F-V, D6F-P and D6F-PH.
- (2) Do not use corrosive gases other than the specified applicable fluids (such as chlorine, sulfur, acid, or alkali). Doing so may cause product failure.
- (3) The specified performance may not be obtained if the D6F is used for fluids other than the specified applicable fluids.
- (4) After removing the Sensor from the package, do not allow foreign particles to enter the piping. Foreign particles in the piping may cause product failure.
- (5) Install the Sensor so that the fluid flows in the direction indicated by the arrow on the Sensor. Correct measurements cannot be obtained if the fluid flows in the wrong direction. This does not apply to the D6F-V, D6F-P and D6F-PH.
- (6) It is recommended that the Sensor (except for the D6F-A3) be mounted horizontally. If it is not mounted horizontally, an error of $\pm 1\%$ FS or higher may result.
- (7) Install the Sensor on a flat surface. Incorrect installation may damage the Sensor and make it impossible to obtain correct measurements.
- (8) Make sure that the power to all equipment is turned OFF before you install the Sensor. Installing the Sensor while the power supply is ON may result in electrical shock or abnormal operation.
- (9) Always check operation after installation.
- (10) Do not drop the Sensor or disassemble the cover.

D6F-A1

- (1) Make sure that pipes with bamboo joints are airtight. Correct measurements cannot be obtained if there is leakage from joints.
- (2) Use M3 panhead screws to install the Sensor, and tighten them to a maximum torque of 0.59 N•m.

D6F-N2/-L2

- (1) Use the Rc 1/4 tapped threads for the pipes, and tighten the threads to a maximum torque of 5 N•m. Tightening beyond this value may result in fractures, which can cause leaks. Apply a suitable amount of pipe sealer. Do not apply sealer on the first two threads from the end of the threaded section. When you tighten the pipes, do not allow foreign matter or oil on the joint area.
- (2) Use M3 panhead screws to install the Sensor, and tighten them to a maximum torque of 0.59 N•m.

D6F-A3

- (1) When installing the pipes, use M5 screws for the joints and tighten to a torque of 1.5 N•m maximum. Use sealing tape to make the joints airtight. Incorrect installation may make it impossible to obtain correct measurements.
- (2) It is recommended that the Sensor be mounted either horizontally or vertically. Mounting the Sensor at an angle may make it impossible to obtain correct measurements.
- (3) Use M3 panhead screws to install the Sensor, and tighten them to a maximum torque of 0.59 N•m.

D6F-A5

- (1) Use M3 panhead screws to install the Sensor, and tighten them to a maximum torque of 0.59 N•m.
- (2) Install O-rings to seal the fluid inlet and outlet points. The recommended O-ring is JIS B 2401, nominal number P5.

Installation Example

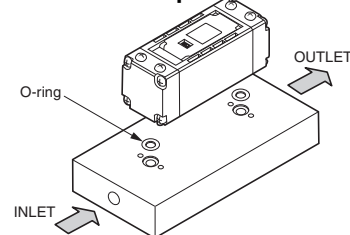

D6F-A6

- (1) Use the appropriate threads (R1/4, NPT1/8 or NPT1/2) for the pipes, and tighten the pipes to a maximum torque of 5 N•m. Tightening beyond this value may result in fractures, which can cause leaks. When you tighten the pipes, do not allow foreign matter or oil on the joint area. Use a spanner or adjustable wrench to turn the connecting section (aluminum alloy) and connect the pipe. Do not place the spanner or wrench on the Sensor (PPS). Doing so may damage the Sensor or result in leaks. Apply a suitable amount of pipe sealer. Do not apply sealer on the first two threads from the end of the threaded section. When you tighten the pipes, do not allow foreign matter or oil on the joint area.
- (2) Use M3 panhead screws to install the Sensor, and tighten them to a maximum torque of 0.59 N•m.

Common Precautions for the D6F Series

D6F-A7/-L7/-N7/-A7D/-AB71/-AB71D

- (1) Use male quick couplings for the piping, and secure them with the applicable quick fasteners.
- (2) Do not apply excessive force to the adapter section when connecting the pipes. If strong force is applied to the connected pipes, or if strong force is applied directly to the adapter section while holding the Sensor, it may damage the Sensor or cause leakage.

Installation Example

Use male, P10-type quick-connect joints for the D6F-A7/-L7/-N7/-A7D and P14-type quick-connect joints for the D6F-AB71/-AB71D.

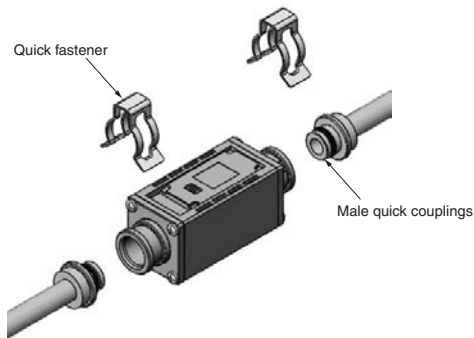

Applicable male quick coupling dimensions (Unit: mm)

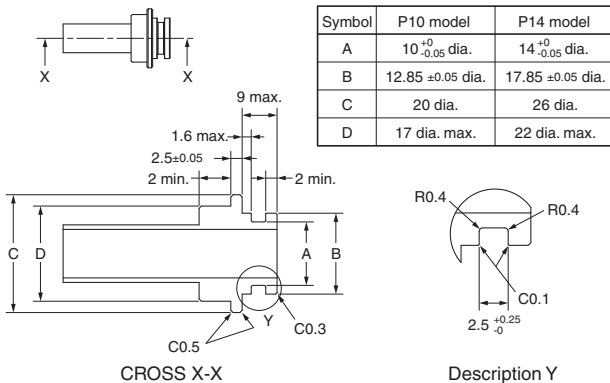

Note. There is a possibility that leak damage or faulty of the body occurs when static load of more than 40 N is applied to 300 mm from the center of product as fulcrum point.

D6F-P0001A1/-P0010A1/-P0010A2

- (1) Depending on the ambient environment and installation location, dust, dirt, and other foreign matter may come in inside the Sensor and block a part or all of the flow path or accumulate on internal components. This may result in the Sensor not being able to perform to the specifications given above. Always perform a pre-evaluation on your actual equipment and be aware of the possible problems that may occur before you use the Sensor with the actual equipment.
- (2) Attach all tubes so that the fluid flows only in the direction from the positive side (+) to the negative side (-). Refer to the figure on page 26 for the installation direction.
- (3) For PCB-mounting Sensors, perform terminal soldering only after the Sensor is secured into place on the PCB. Use a soldering iron for 5 s at 350°C with a pressure of 100 gf max. (This applies only to PCB-mounting Sensors.)
- (4) Use M2.6 panhead screws or equivalent tapping screws to mount the Sensor, and tighten the screws to a maximum torque of 0.59 N•m.

D6F-P0010AM2

- (1) Depending on the ambient environment and installation location, dust, dirt, and other foreign matter may come in inside the Sensor and block a part or all of the flow path or accumulate on internal components. This may result in the Sensor not being able to perform to the specifications given above. Always perform a pre-evaluation on your actual equipment and be aware of the possible problems that may occur before you use the Sensor with the actual equipment.
- (2) Attach all tubes so that the fluid flows only in the direction from the positive side (+) to the negative side (-). Install the Sensor with the manifold facing downward. Refer to the figure on page 26 for the installation direction.
- (3) Use M3 panhead screws or equivalent tapping screws to mount the Sensor, and tighten the screws to a maximum torque of 0.59 N•m.
- (4) Install O-rings to seal the fluid inlet and outlet points. The recommended O-ring is JIS B 2401, nominal number P4.

Installation Example

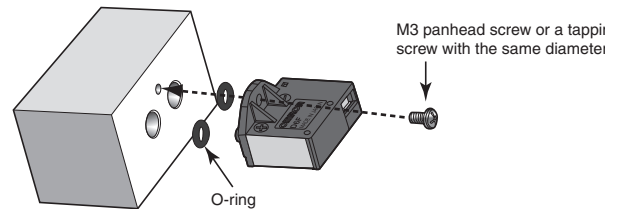

D6F-PH

- (1) Depending on the ambient environment and installation location, dust, dirt, and other foreign matter may come in inside the Sensor and block a part or all of the flow path or accumulate on internal components. This may result in the Sensor not being able to perform to the specifications given above. Always perform a pre-evaluation on your actual equipment and be aware of the possible problems that may occur before you use the Sensor with the actual equipment.
- (2) Attach all tubes so that the fluid flows only in the direction from the high pressure side (+) to the low pressure side (-).
- (3) Use M1.8 panhead screws or equivalent tapping screws to mount the Sensor, and tighten the screws to a maximum torque of 0.36 N•m.
- (4) The sensor output is affected with the length of a tube. The error is less than 1% with a tube (ID:4mm) length up to 800mm.
- (5) Connection
 - Wire with the correct terminal names and polarities. Incorrect wiring will cause failure of internal components.
 - Do not use flow soldering.
 - Please solder after fixed on the circuit board by screw.
 - Use a soldering iron:
 - Soldering condition Pressure Max.100gf
 - Temperature 350 degree C
 - Time Max. 5s

Common Precautions for the D6F Series

D6F-W

- (1) Depending on the ambient environment and installation location, dust, dirt, and other foreign matter may come in inside the Sensor and block a part or all of the flow path or accumulate on internal components. This may result in the Sensor not being able to perform to the specifications given above. Always perform a pre-evaluation on your actual equipment and be aware of the possible problems that may occur before you use the Sensor with the actual equipment.
- (2) Use M3 panhead screws to install the Sensor, and tighten them to a maximum torque of 0.59 N•m.

D6F-V

- (1) Depending on the ambient environment and installation location, dust, dirt, and other foreign matter may come in inside the Sensor and block a part or all of the flow path or accumulate on internal components. This may result in the Sensor not being able to perform to the specifications given above. Always perform a pre-evaluation on your actual equipment and be aware of the possible problems that may occur before you use the Sensor with the actual equipment.
- (2) Use M3 panhead screws to install the Sensor, and tighten them to a maximum torque of 0.59 N•m.
- (3) This Sensor does not contain any protective circuits. Never allow the electrical load to exceed the maximum ratings. Doing so may damage the circuits. Install protective circuits if required.
- (4) Mount the Sensor so that the flow inlet side (the side with the logo) is perpendicular to the windward side and ensure that the flow inlet and flow outlet are not blocked in any way. If the Sensor is not mounted correctly, accurate measurements cannot be made.

Installation Example

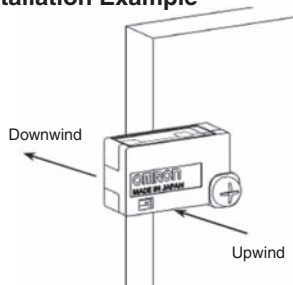

● Operating Environment

Do not use the Sensor in the following locations:

- Locations directly subject to heat radiated from heating equipment
- Locations subject to water or oil
- Locations subject to direct sunlight
- Locations subject to intense temperature changes
- Locations subject to icing or condensation
- Locations subject to excessive vibration or shock

● Countermeasures against Noise

Noise may make it impossible to obtain correct measurements. Consider the following countermeasures.

- Allow as much space as possible between the Sensor and devices that generates high frequencies (such as high-frequency welders and high-frequency sewing machines) or surges.
- Attach surge absorbers or noise filters to noise-generating devices that are near the Sensor (in particular, equipment with inductance, such as motors, transformers, solenoids, and magnetic coils).
(It also helps to separate pipes and ducts, and to use shielded cables.)

● Power Supply

- Force of connector terminal is 20 N max. Do not add strength more than tension of wire bending to connector at wiring. Install the connector coaxially to the fitting axis with holding all wires. And pulling angle should be within 15 degrees.
- Use the applicable connectors. Directly soldering the connection terminals will cause product failure. (except for the D6F-PH)
- Check the terminal names and polarity and wire the power supply correctly. Incorrect wiring will cause failure of internal components.
- When using a commercially available switching regulator, ground the FG (frame ground) and G (ground) terminals.

● Handling

The sensor is a precision device, and if large shock and load is applied, it may cause a failure or characteristic change. Please do not use the sensor which is added excessive shock to the terminals, discompose the cover, or has fallen.

- The sensor shall only be handled in electrostatic discharge protected areas (EPA) under protected and controlled conditions

RoHS Directive

The RoHS mark is displayed on the packing of products for which the six substances banned by the RoHS Directive have been abolished (both in processing and in the electronic components mounted to the PCBs).

* RoHS marking may be terminated if it is later determined that parts that were previously treated as RoHS compliant are not compliant due to circumstances at the supplier of the parts.

● RoHS Compliance Criteria

The following standards are used to determine RoHS compliance for the six banned substances.

(Items to which the RoHS Directive is not applicable are not given.)

- Lead: 1,000 ppm max.
- Hexavalent chromium: 1,000 ppm max.
- Mercury: 1,000 ppm max.
- PBB: 1,000 ppm max.
- Cadmium: 100 ppm max.
- PBDE: 1,000 ppm max.

Terms and Conditions Agreement

Read and understand this catalog.

Please read and understand this catalog before purchasing the products. Please consult your OMRON representative if you have any questions or comments.

Warranties.

- (a) Exclusive Warranty. Omron's exclusive warranty is that the Products will be free from defects in materials and workmanship for a period of twelve months from the date of sale by Omron (or such other period expressed in writing by Omron). Omron disclaims all other warranties, express or implied.
- (b) Limitations. OMRON MAKES NO WARRANTY OR REPRESENTATION, EXPRESS OR IMPLIED, ABOUT NON-INFRINGEMENT, MERCHANTABILITY OR FITNESS FOR A PARTICULAR PURPOSE OF THE PRODUCTS. BUYER ACKNOWLEDGES THAT IT ALONE HAS DETERMINED THAT THE PRODUCTS WILL SUITABLY MEET THE REQUIREMENTS OF THEIR INTENDED USE.

Omron further disclaims all warranties and responsibility of any type for claims or expenses based on infringement by the Products or otherwise of any intellectual property right. (c) Buyer Remedy. Omron's sole obligation hereunder shall be, at Omron's election, to (i) replace (in the form originally shipped with Buyer responsible for labor charges for removal or replacement thereof) the non-complying Product, (ii) repair the non-complying Product, or (iii) repay or credit Buyer an amount equal to the purchase price of the non-complying Product; provided that in no event shall Omron be responsible for warranty, repair, indemnity or any other claims or expenses regarding the Products unless Omron's analysis confirms that the Products were properly handled, stored, installed and maintained and not subject to contamination, abuse, misuse or inappropriate modification. Return of any Products by Buyer must be approved in writing by Omron before shipment. Omron Companies shall not be liable for the suitability or unsuitability or the results from the use of Products in combination with any electrical or electronic components, circuits, system assemblies or any other materials or substances or environments. Any advice, recommendations or information given orally or in writing, are not to be construed as an amendment or addition to the above warranty.

See <http://www.omron.com/global/> or contact your Omron representative for published information.

Limitation on Liability; Etc.

OMRON COMPANIES SHALL NOT BE LIABLE FOR SPECIAL, INDIRECT, INCIDENTAL, OR CONSEQUENTIAL DAMAGES, LOSS OF PROFITS OR PRODUCTION OR COMMERCIAL LOSS IN ANY WAY CONNECTED WITH THE PRODUCTS, WHETHER SUCH CLAIM IS BASED IN CONTRACT, WARRANTY, NEGLIGENCE OR STRICT LIABILITY.

Further, in no event shall liability of Omron Companies exceed the individual price of the Product on which liability is asserted.

Suitability of Use.

Omron Companies shall not be responsible for conformity with any standards, codes or regulations which apply to the combination of the Product in the Buyer's application or use of the Product. At Buyer's request, Omron will provide applicable third party certification documents identifying ratings and limitations of use which apply to the Product. This information by itself is not sufficient for a complete determination of the suitability of the Product in combination with the end product, machine, system, or other application or use. Buyer shall be solely responsible for determining appropriateness of the particular Product with respect to Buyer's application, product or system. Buyer shall take application responsibility in all cases.

NEVER USE THE PRODUCT FOR AN APPLICATION INVOLVING SERIOUS RISK TO LIFE OR PROPERTY OR IN LARGE QUANTITIES WITHOUT ENSURING THAT THE SYSTEM AS A WHOLE HAS BEEN DESIGNED TO ADDRESS THE RISKS, AND THAT THE OMRON PRODUCT(S) IS PROPERLY RATED AND INSTALLED FOR THE INTENDED USE WITHIN THE OVERALL EQUIPMENT OR SYSTEM.

Programmable Products.

Omron Companies shall not be responsible for the user's programming of a programmable Product, or any consequence thereof.

Performance Data.

Data presented in Omron Company websites, catalogs and other materials is provided as a guide for the user in determining suitability and does not constitute a warranty. It may represent the result of Omron's test conditions, and the user must correlate it to actual application requirements. Actual performance is subject to the Omron's Warranty and Limitations of Liability.

Change in Specifications.

Product specifications and accessories may be changed at any time based on improvements and other reasons. It is our practice to change part numbers when published ratings or features are changed, or when significant construction changes are made. However, some specifications of the Product may be changed without any notice. When in doubt, special part numbers may be assigned to fix or establish key specifications for your application. Please consult with your Omron's representative at any time to confirm actual specifications of purchased Product.

Errors and Omissions.

Information presented by Omron Companies has been checked and is believed to be accurate; however, no responsibility is assumed for clerical, typographical or proofreading errors or omissions.

Please check each region's Terms & Conditions by region website.

OMRON Corporation

Electronic and Mechanical Components Company

Regional Contact

Americas

<https://www.components.omron.com/>

Asia-Pacific

<https://ecb.omron.com.sg/>

Korea

<https://www.omron-ecb.co.kr/>

Europe

<http://components.omron.eu/>

China

<https://www.ecb.omron.com.cn/>

Japan

<https://www.omron.co.jp/ecb/>

Mouser Electronics

Authorized Distributor

Click to View Pricing, Inventory, Delivery & Lifecycle Information:

Omron:

[D6F-05N2-000](#) [D6F-10A5-000](#) [D6F-20A5-000](#) [D6F-50A5-000](#) [D6F-10A6-000](#) [D6F-20A6-000](#) [D6F-01N2-000](#) [D6F-02L2-000](#) [D6F-P0010A2](#) [D6F-P0010A1](#) [D6F-P0010AM2](#) [D6F-V03A1](#) [D6F-20A61-000](#) [D6F-50A6-000](#) [D6F-02L7-000](#) [D6F-05N7-000](#) [D6F-10A61-000](#) [D6F-P0001A1](#) [D6F-70AB71D-000-0](#) [D6F-CABLE3](#) [D6FZ-FGT200](#) [D6FZ-JD10A](#)

Данный компонент на территории Российской Федерации

Вы можете приобрести в компании MosChip.

Для оперативного оформления запроса Вам необходимо перейти по данной ссылке:

<http://moschip.ru/get-element>

Вы можете разместить у нас заказ для любого Вашего проекта, будь то серийное производство или разработка единичного прибора.

В нашем ассортименте представлены ведущие мировые производители активных и пассивных электронных компонентов.

Нашей специализацией является поставка электронной компонентной базы двойного назначения, продукции таких производителей как XILINX, Intel (ex.ALTERA), Vicor, Microchip, Texas Instruments, Analog Devices, Mini-Circuits, Amphenol, Glenair.

Сотрудничество с глобальными дистрибьюторами электронных компонентов, предоставляет возможность заказывать и получать с международных складов практически любой перечень компонентов в оптимальные для Вас сроки.

На всех этапах разработки и производства наши партнеры могут получить квалифицированную поддержку опытных инженеров.

Система менеджмента качества компании отвечает требованиям в соответствии с ГОСТ Р ИСО 9001, ГОСТ РВ 0015-002 и ЭС РД 009

Офис по работе с юридическими лицами:

105318, г.Москва, ул.Щербаковская д.3, офис 1107, 1118, ДЦ «Щербаковский»

Телефон: +7 495 668-12-70 (многоканальный)

Факс: +7 495 668-12-70 (доб.304)

E-mail: info@moschip.ru

Skype отдела продаж:

moschip.ru

moschip.ru_4

moschip.ru_6

moschip.ru_9