

ZXCT1020

Low offset current output current monitor

Description

The ZXCT1020 is a precision high-side current sense monitor. Using this type of device eliminates the need to disrupt the ground plane when sensing a load current.

The ZXCT1020 uses two external resistors to set the overall voltage gain for applications where improved accuracy at small sense voltages is required. For fixed gain variants Zetex offers the ZXCT1021 (G=10) and ZXCT1022 (G=100).

The ZXCT1020 footprint follows that of the ZXCT1021/2 with only 2 additional resistors required:

One resistor between pins 1 and 4 for setting transconductance, and the other between pins 3 and 2 for setting overall gain.

Features

- Accurate high-side current sensing
- Versatile current output scaling
- 2.5V - 20V operating range
- 25 μ A quiescent current
- 1% typical accuracy
- SOT23-5 package

Pinout information

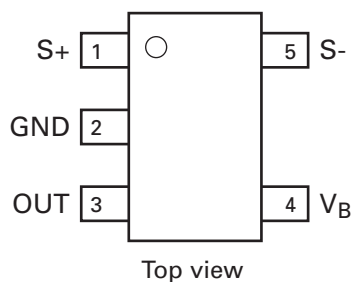

Current output enables the user to set the gain via these external resistors. Using two external resistors to set the gain ensures optimal versatility as the transconductance can be varied to meet the output impedance requirements of the load that the ZXCT1020 has to drive.

The very low offset voltage enables a typical accuracy of 3% for sense voltages of only 10mV, giving better tolerances for small sense resistors necessary at higher currents.

The wide input voltage range of 20V down to as low as 2.5V make it suitable for a range of applications. With a minimum operating current of just 25 μ A, combined with its SOT23-5 package make it suitable for portable battery equipment too.

Applications

- Battery chargers
- Over-current monitor
- Motherboard power supply current measurement
- Level translating
- Programmable current source

Typical application circuit

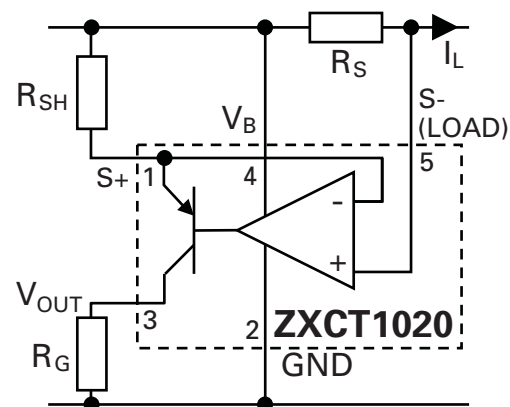

Ordering information

Order reference	Package	Device marking	Status	Reel size (inches)	Quantity per reel	Tape width (mm)
ZXCT1020E5TA	SOT23-5	1020	Preview	7	3000	8

Absolute maximum ratings

Voltage on V_B with respect to GND pin	-0.5V to 20V
Voltage on S_+ ^(a) , S_- ^(b) , OUT with respect to GND pin	-0.5V to $V_B+0.5V$
V_{SENSE} ^(c)	-0.5V to +2.5V ^(d)
Junction temperature	-40°C to 125°C
Storage temperature	-55°C to 150°C
Package power dissipation ($T_{amb} = 25^\circ C$) SOT23-5	300mW

NOTES:

(a) Subject to V_{SENSE+} never going 6V below V_B .

(b) Subject to absolute maximum V_{SENSE} not being exceeded.

(c) V_{SENSE} is defined as the voltage difference across the sense resistor, and is the voltage across resistor R_{SH} plus the voltage between S_+ and S_- .

(d) V_{SENSE} might need to be reduced when used with smaller values of R_{SH} and at larger rails due to increased power dissipation.

Pin out information

Pin	Name	Pin function
1	S_+	Positive sense input. Should be tied to positive side of sense resistor via resistance (R_{SH}) of the order of 150Ω to 1.5kΩ.
2	GND	Ground and substrate connection of device.
3	OUT	Current output. A gain setting resistor (R_G) referenced to GND should be connected to this pin to set overall voltage gain of: $\text{Gain} = R_G/R_{SH}$ The resistance, R_G , placed on out will set the ZXCT1020 output impedance equal to R_G . When driving low impedance loads both R_G and R_{SH} should be reduced.
4	V_B	Input voltage pin. Provides bias to current monitor and should be tied to the rail whose current is being monitored.
5	S_-	High impedance negative sense voltage input

Recommended operating conditions

Parameter	Min.	Max.	Units
V_{SENSE+} Common-mode sense input range	2.5	20	V
V_B Bias pin input voltage range ^(*)	2.5	20	V
V_{SENSE} Differential sense Input voltage range	0	1.5	V
V_{OUT} Output voltage range	0	$V_{SENSE-} - 1$	V
R_{SH} Shunt resistor value	120	2000	Ω
T_A Ambient temperature range	-40	85	°C

NOTES:

(*) For best performance V_B and V_{SENSE+} should be referred to the rail whose current is being measured.

Recommended resistor gain setting combinations

Gain	R_{SHUNT}	R_{GAIN}
10	1.5kΩ	15kΩ
20	750Ω	15kΩ
50	300Ω	15kΩ
100	150Ω	15kΩ

Electrical characteristics

$T_{amb} = 25^{\circ}\text{C}$, $V_{SENSE+} = V_B = 15\text{V}$, $V_{SENSE} = 100\text{mV}$, $R_G = 15\text{k}\Omega$, $R_{SH} = 1.5\text{k}\Omega$ unless otherwise stated.

Symbol	Parameter	Conditions	Limits			Unit
			Min.	Typ.	Max.	
V _{OUT}	Output voltage	V _{SENSE} = 0mV		3	15	mV
		V _{SENSE} = 30mV	291	300	309	mV
		V _{SENSE} = 100mV	0.98	1	1.02	V
		V _{SENSE} = 150mV	1.47	1.5	1.53	V
TC[1]	Output voltage temperature coefficient			50	300	ppm
I _Q	Ground pin current	V _{SENSE} = 0V		25	35	μA
I _{S-}	S- input current	V _{SENSE} = 0V		20	100	nA
I _{S+}	S+ input current	V _{SENSE} = 0V		100		nA
Acc	Accuracy	V _{SENSE} = 100mV	-2		2	%
Gain	V _{OUT} / V _{SENSE}	V _{SENSE} = 100mV		10		V/V
R _{OUT}	Output resistance	R _G not connected		370		MΩ
BW	Bandwidth	V _{SENSE} (DC) = 10mV		300		kHz
		V _{SENSE} (DC) = 100mV		2		MHz
PSRR	Power supply rejection ratio	V _{SENSE+} = V _B = 2.5 to 20V	70	80		dB

Typical characteristics

Test conditions unless otherwise stated: $T_A = 25^\circ\text{C}$, $V_B = V_{\text{SENSE}+}$ (via $R_{\text{SH}} = 15\text{V}$, $V_{\text{SENSE}} = 100\text{mV}$, $R_{\text{SH}} = 1.5\text{k}\Omega$, $R_G = 15\text{k}\Omega$.

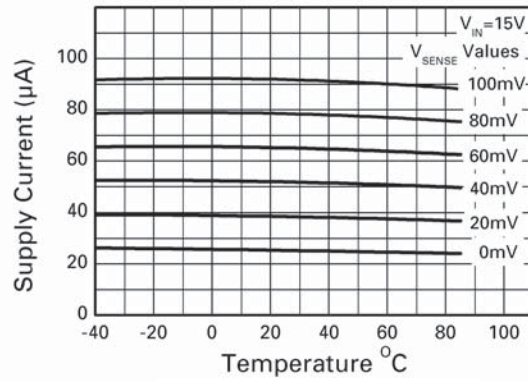

Supply current v Temperature

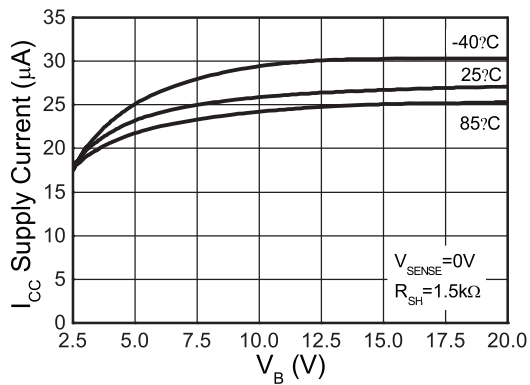

Supply Current v V_B

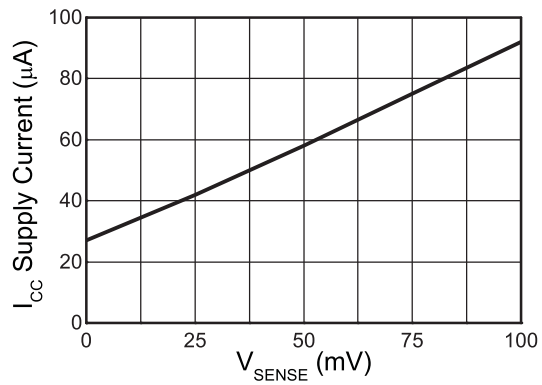

Supply Current v V_{SENSE}

ZXCT1020

Test conditions unless otherwise stated: $T_A = 25^\circ\text{C}$, $V_B = V_{\text{SENSE}+}$ (via $R_{\text{SH}} = 15\text{V}$, $V_{\text{SENSE}} = 100\text{mV}$
Gain = 10, $R_G = 15\text{k}\Omega$.

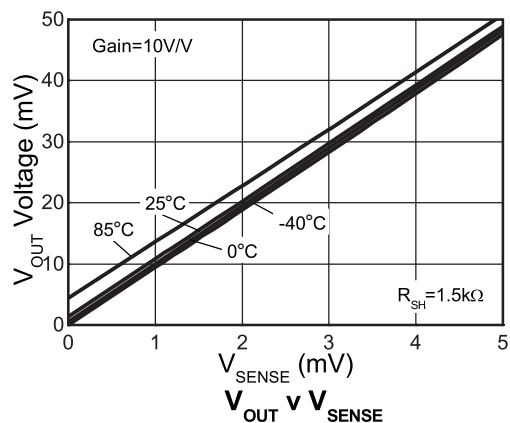
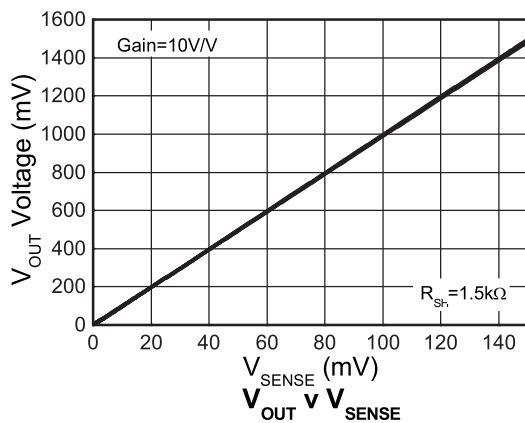
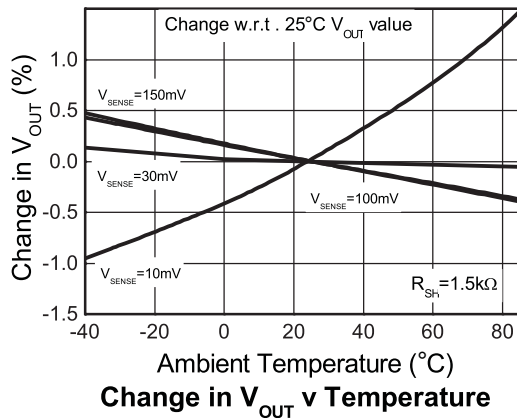
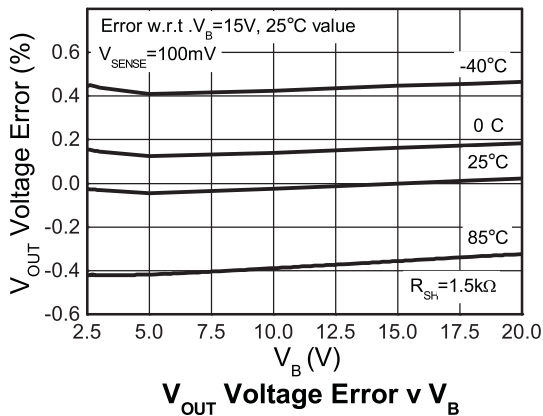
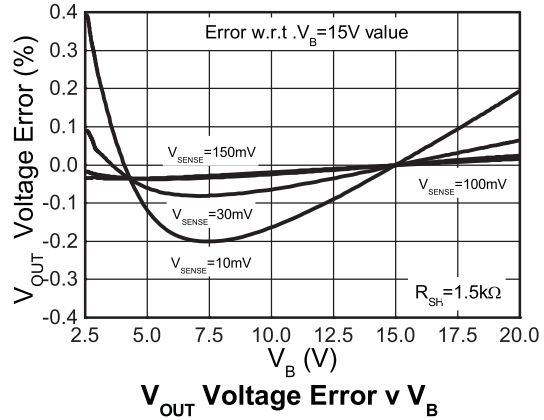
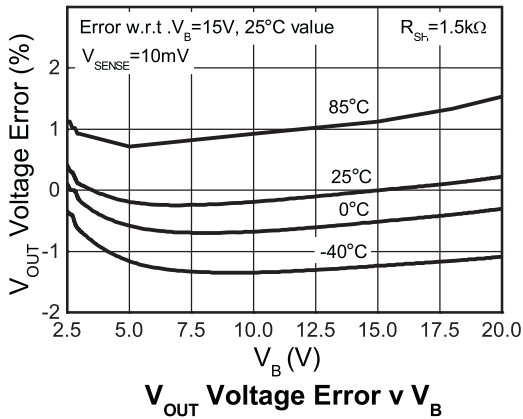

ZXCT1020

Test conditions unless otherwise stated: $T_A = 25^\circ\text{C}$, $V_B = V_{\text{SENSE}+}$ (via $R_{\text{SH}} = 15\text{k}\Omega$), $V_{\text{SENSE}} = 100\text{mV}$
 Gain = 20, $R_G = 15\text{k}\Omega$.

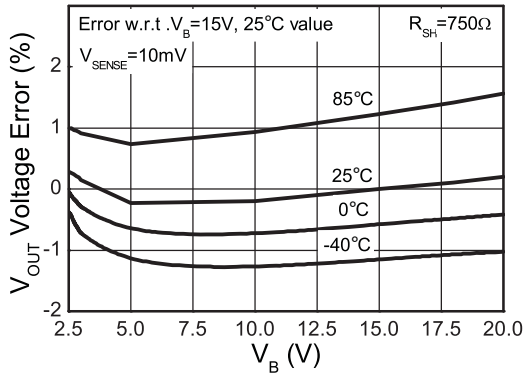

V_{OUT} Voltage Error v V_B

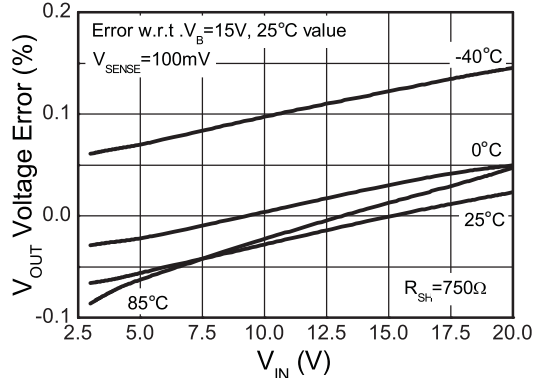

V_{OUT} Voltage Error v V_{IN}

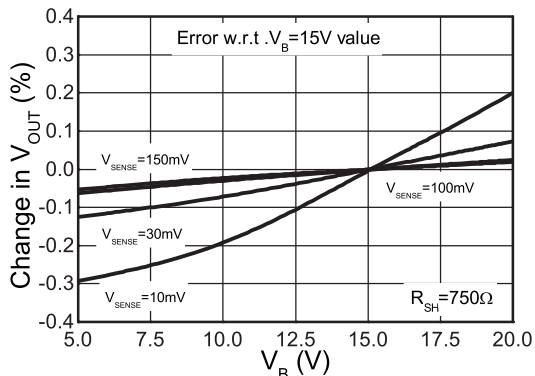

V_{OUT} Voltage Error v V_B

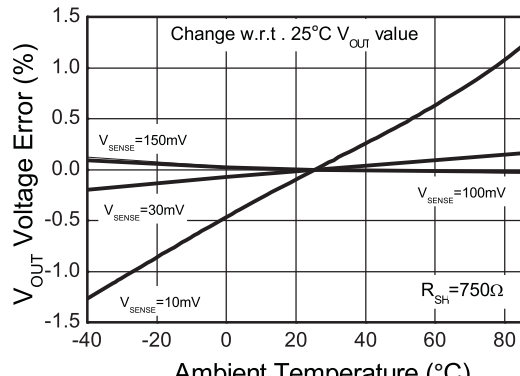

Change in V_{OUT} v Temperature

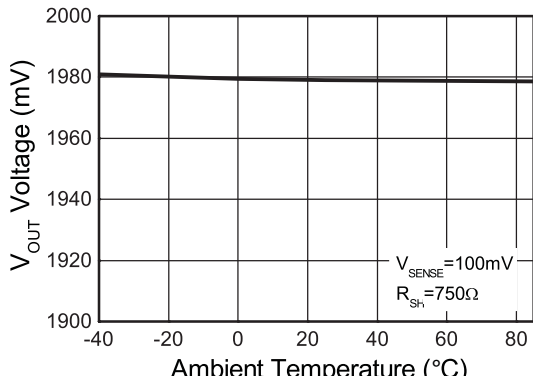

V_{OUT} v Ambient Temperature

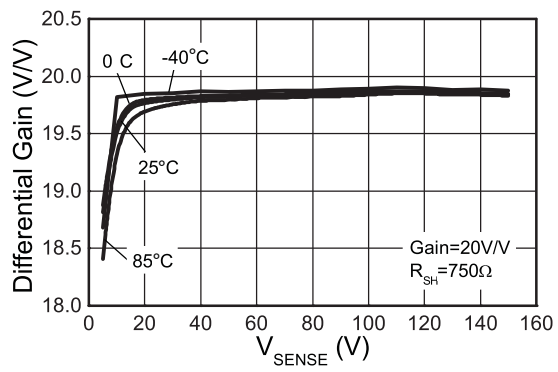

Differential Gain v V_{SENSE}

ZXCT1020

Test conditions unless otherwise stated: $T_A = 25^\circ\text{C}$, $V_B = V_{\text{SENSE}+}$ (via $R_{\text{SH}} = 15\text{V}$, $V_{\text{SENSE}} = 100\text{mV}$, $R_G = 15\text{k}\Omega$.

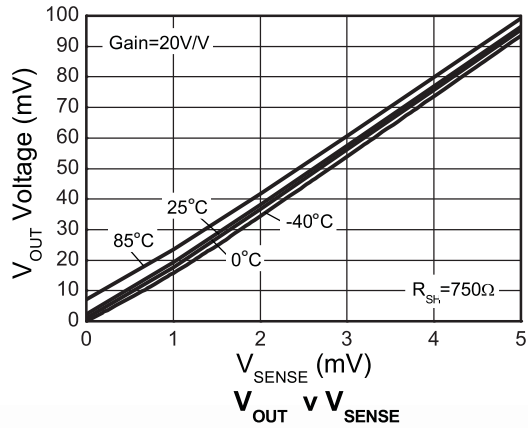
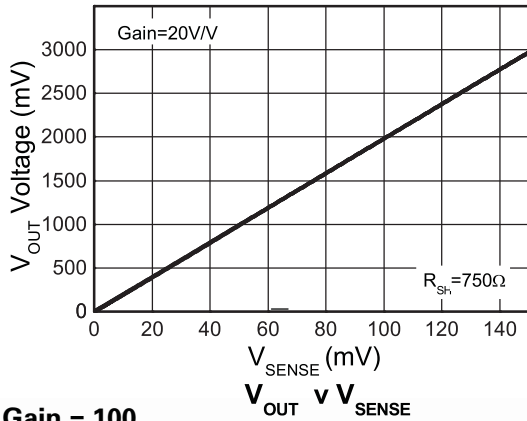

Gain = 100

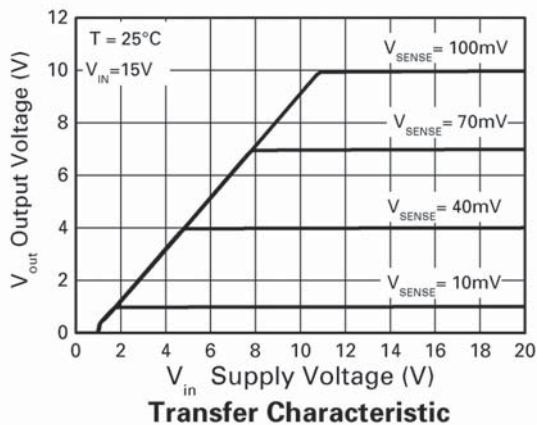
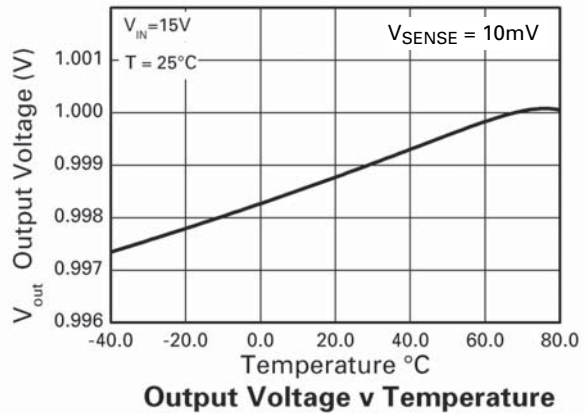
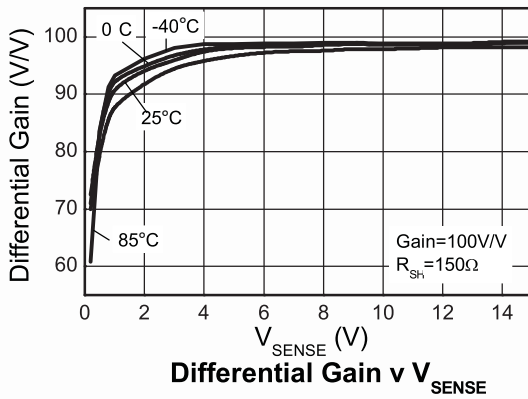

Typical AC characteristics

Test conditions unless otherwise stated: $T_A = 25^\circ\text{C}$, $V_B = V_{\text{SENSE}+}$ (via $R_{\text{SH}} = 15\text{V}$, $V_{\text{SENSE}} = 100\text{mV}$, $R_G = 15\text{k}\Omega$

Gain = 10

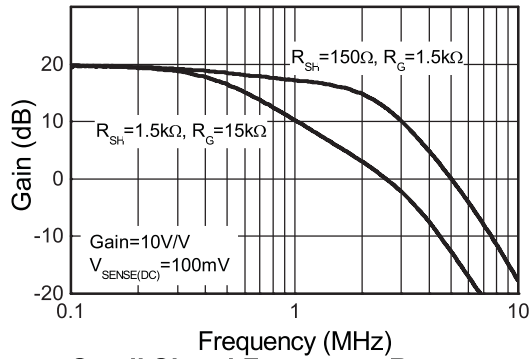

Small Signal Frequency Response

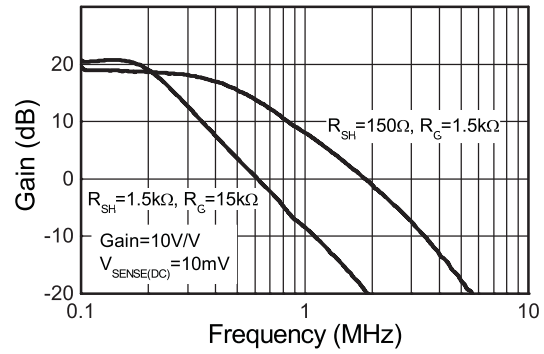

Small Signal Frequency Response

Gain = 50

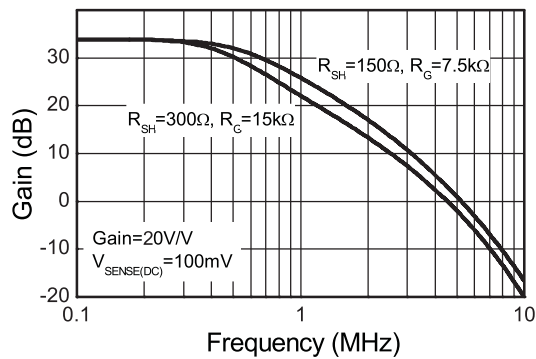

Large Signal Frequency Response

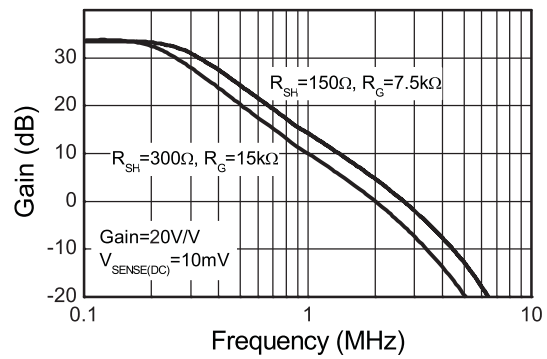

Small Signal Frequency Response

Test conditions unless otherwise stated: $T_A = 25^\circ\text{C}$, $R_G = 15\text{k}\Omega$, $V_B = V_{\text{SENSE}+}$ (via $R_{\text{SH}} = 15\text{V}$, $V_{\text{SENSE}} = 100\text{mV}$ unless otherwise stated.

Various gains with constant R_G

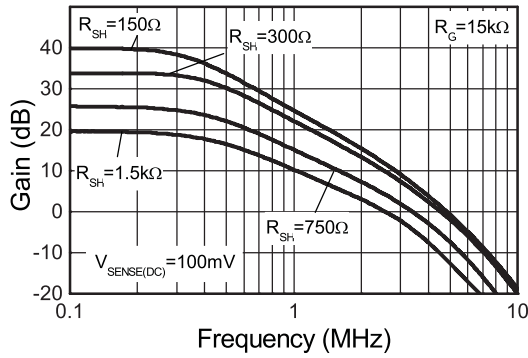

Frequency Response with constant R_G

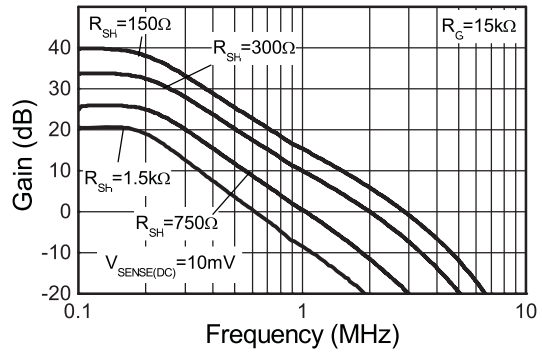

Frequency Response with constant R_G

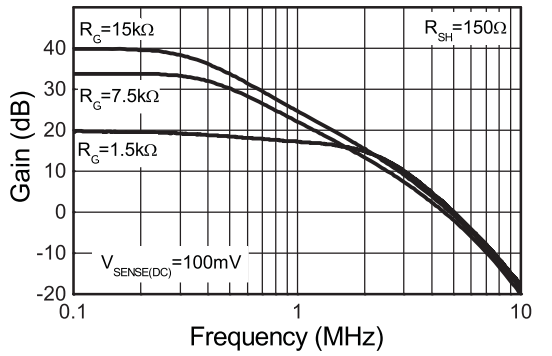

Frequency Response with constant R_{SH}

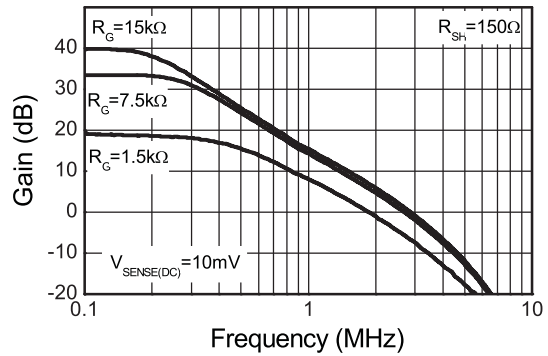

Frequency Response with constant R_{SH}

ZXCT1020

Test conditions unless otherwise stated: $T_A = 25^\circ\text{C}$, $G=100$, $R_G = 15\text{k}$, $V_B = V_{\text{SENSE}+}$ (via R_{SH}), $V_{\text{SENSE}} = 100\text{mV}$.

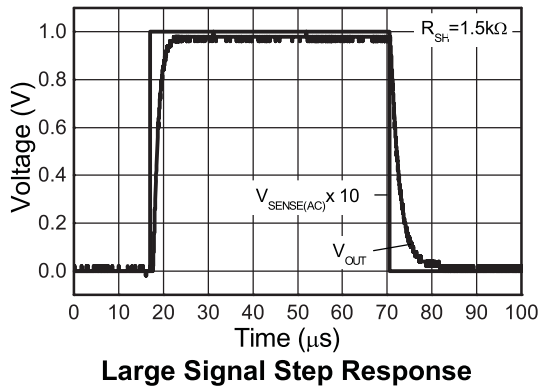
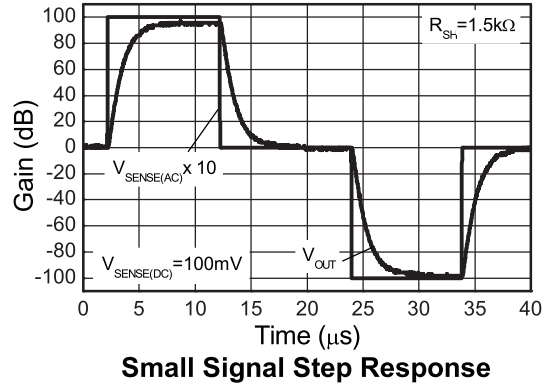
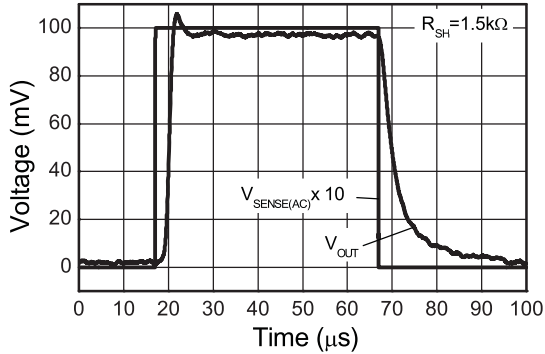

Application information

The ZXCT1020 has a V_B pin that is used to provide power to the current monitor. The maximum voltage applied to the ZXCT1020 must be applied to this pin. The S+ and S- pins are used to measure the current flowing to the load through the sense resistor. In normal use, the S+ is tied to V_B via a shunt resistor, R_{SH} making the ZXCT1020 essentially line powered.

The ZXCT1020 has a programmable gain set by the ratio of two external resistors R_G and R_{SH} .

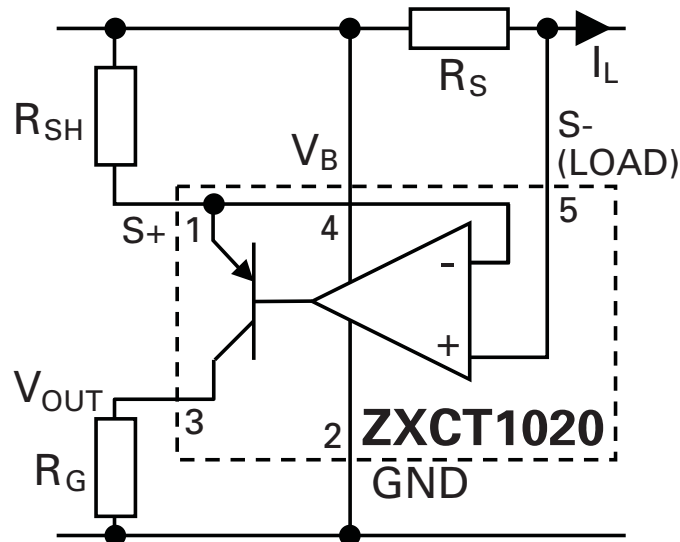

R_{SH} sets the transconductance whereas R_G set the gain and results in an output voltage defined as:

$$V_{OUT} = \frac{R_G}{R_{SH}} \times V_{SENSE}$$

$$\text{Where } V_{SENSE} = R_{SENSE} \times I_L$$

The ZXCT1020 has been tested to the same conditions as the ZXCT1021 giving an overall voltage gain of 10. The gain of the ZXCT1020 can be adjusted simply by varying R_G . So to achieve a gain of 50 R_G is increased from $15k\Omega$ to $75k\Omega$. An alternative is to decrease R_{SH} from $1.5k\Omega$ to 300Ω .

Decreasing R_{SH} increases the transconductance and, if for any given gain, reducing the R_{SH} will reduce the overall output impedance.

To achieve a gain of 100, for example, the following resistor values could be used:

$$R_{SH} = 150 \quad R_G = 15k$$

Intentionally left blank

ZXCT1020

Package outline - SOT23-5

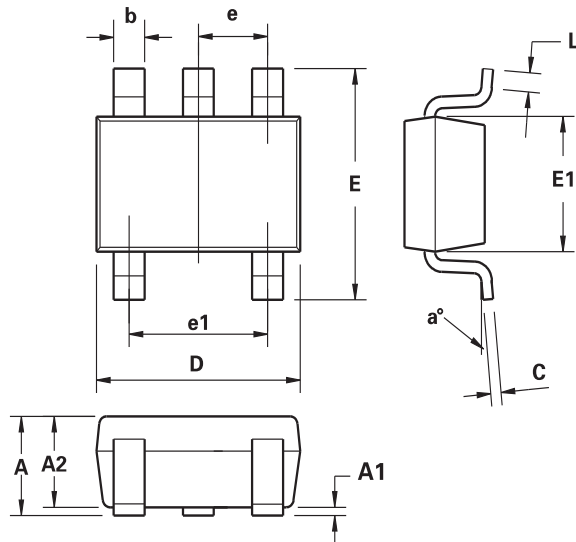

Dim.	Millimeters		Inches	
	Min.	Max.	Min.	Max.
A	0.90	1.45	0.0354	0.0570
A1	0.00	0.15	0.00	0.0059
A2	0.90	1.30	0.0354	0.0511
b	0.20	0.50	0.0078	0.0196
C	0.09	0.26	0.0035	0.0102
D	2.70	3.10	0.1062	0.1220
E	2.20	3.20	0.0866	0.1181
E1	1.30	1.80	0.0511	0.0708
e	0.95 REF		0.0374 REF	
e1	1.90 REF		0.0748 REF	
L	0.10	0.60	0.0039	0.0236
a°	0°	30°	0°	30°

Note: Controlling dimensions are in millimeters. Approximate dimensions are provided in inches

Definitions

Product change

Zetex Semiconductors reserves the right to alter, without notice, specifications, design, price or conditions of supply of any product or service. Customers are solely responsible for obtaining the latest relevant information before placing orders.

Applications disclaimer

The circuits in this design/application note are offered as design ideas. It is the responsibility of the user to ensure that the circuit is fit for the user's application and meets with the user's requirements. No representation or warranty is given and no liability whatsoever is assumed by Zetex with respect to the accuracy or use of such information, or infringement of patents or other intellectual property rights arising from such use or otherwise. Zetex does not assume any legal responsibility or will not be held legally liable (whether in contract, tort (including negligence), breach of statutory duty, restriction or otherwise) for any damages, loss of profit, business, contract, opportunity or consequential loss in the use of these circuit applications, under any circumstances.

Life support

Zetex products are specifically not authorized for use as critical components in life support devices or systems without the express written approval of the Chief Executive Officer of Zetex Semiconductors plc. As used herein:

A. Life support devices or systems are devices or systems which:

1. are intended to implant into the body

or

2. support or sustain life and whose failure to perform when properly used in accordance with instructions for use provided in the labelling can be reasonably expected to result in significant injury to the user.

B. A critical component is any component in a life support device or system whose failure to perform can be reasonably expected to cause the failure of the life support device or to affect its safety or effectiveness.

Reproduction

The product specifications contained in this publication are issued to provide outline information only which (unless agreed by the company in writing) may not be used, applied or reproduced for any purpose or form part of any order or contract or be regarded as a representation relating to the products or services concerned.

Terms and Conditions

All products are sold subjects to Zetex' terms and conditions of sale, and this disclaimer (save in the event of a conflict between the two when the terms of the contract shall prevail) according to region, supplied at the time of order acknowledgement.

For the latest information on technology, delivery terms and conditions and prices, please contact your nearest Zetex sales office.

Quality of product

Zetex is an ISO 9001 and TS16949 certified semiconductor manufacturer.

To ensure quality of service and products we strongly advise the purchase of parts directly from Zetex Semiconductors or one of our regionally authorized distributors. For a complete listing of authorized distributors please visit: www.zetex.com/salesnetwork

Zetex Semiconductors does not warrant or accept any liability whatsoever in respect of any parts purchased through unauthorized sales channels.

ESD (Electrostatic discharge)

Semiconductor devices are susceptible to damage by ESD. Suitable precautions should be taken when handling and transporting devices. The possible damage to devices depends on the circumstances of the handling and transporting, and the nature of the device. The extent of damage can vary from immediate functional or parametric malfunction to degradation of function or performance in use over time. Devices suspected of being affected should be replaced.

Green compliance

Zetex Semiconductors is committed to environmental excellence in all aspects of its operations which includes meeting or exceeding regulatory requirements with respect to the use of hazardous substances. Numerous successful programs have been implemented to reduce the use of hazardous substances and/or emissions.

All Zetex components are compliant with the RoHS directive, and through this it is supporting its customers in their compliance with WEEE and ELV directives.

Product status key:

"Preview"	Future device intended for production at some point. Samples may be available
"Active"	Product status recommended for new designs
"Last time buy (LTB)"	Device will be discontinued and last time buy period and delivery is in effect
"Not recommended for new designs"	Device is still in production to support existing designs and production
"Obsolete"	Production has been discontinued

Datasheet status key:

"Draft version"	This term denotes a very early datasheet version and contains highly provisional information, which may change in any manner without notice.
"Provisional version"	This term denotes a pre-release datasheet. It provides a clear indication of anticipated performance. However, changes to the test conditions and specifications may occur, at any time and without notice.
"Issue"	This term denotes an issued datasheet containing finalized specifications. However, changes to specifications may occur, at any time and without notice.

Zetex sales offices

Europe	Americas	Asia Pacific	Corporate Headquarters
Zetex GmbH Kustermannpark Balanstraße 59 D-81541 München Germany Telephone: (49) 89 45 49 49 0 Fax: (49) 89 45 49 49 49 europe.sales@zetex.com	Zetex Inc 700 Veterans Memorial Highway Hauppauge, NY 11788 USA Telephone: (1) 631 360 2222 Fax: (1) 631 360 8222 usa.sales@zetex.com	Zetex (Asia Ltd) 3701-04 Metroplaza Tower 1 Hing Fong Road, Kwai Fong Hong Kong Telephone: (852) 26100 611 Fax: (852) 24250 494 asia.sales@zetex.com	Zetex Semiconductors plc Zetex Technology Park, Chadderton Oldham, OL9 9LL United Kingdom Telephone: (44) 161 622 4444 Fax: (44) 161 622 4446 hq@zetex.com

© 2007 Published by Zetex Semiconductors plc

Данный компонент на территории Российской Федерации

Вы можете приобрести в компании MosChip.

Для оперативного оформления запроса Вам необходимо перейти по данной ссылке:

<http://moschip.ru/get-element>

Вы можете разместить у нас заказ для любого Вашего проекта, будь то серийное производство или разработка единичного прибора.

В нашем ассортименте представлены ведущие мировые производители активных и пассивных электронных компонентов.

Нашей специализацией является поставка электронной компонентной базы двойного назначения, продукции таких производителей как XILINX, Intel (ex.ALTERA), Vicor, Microchip, Texas Instruments, Analog Devices, Mini-Circuits, Amphenol, Glenair.

Сотрудничество с глобальными дистрибьюторами электронных компонентов, предоставляет возможность заказывать и получать с международных складов практически любой перечень компонентов в оптимальные для Вас сроки.

На всех этапах разработки и производства наши партнеры могут получить квалифицированную поддержку опытных инженеров.

Система менеджмента качества компании отвечает требованиям в соответствии с ГОСТ Р ИСО 9001, ГОСТ РВ 0015-002 и ЭС РД 009

Офис по работе с юридическими лицами:

105318, г.Москва, ул.Щербаковская д.3, офис 1107, 1118, ДЦ «Щербаковский»

Телефон: +7 495 668-12-70 (многоканальный)

Факс: +7 495 668-12-70 (доб.304)

E-mail: info@moschip.ru

Skype отдела продаж:

moschip.ru

moschip.ru_4

moschip.ru_6

moschip.ru_9