

# TOKIN

## NEW PRODUCTS

---

English

---

Vol.  
**08**



- All specifications in this catalog and production status of products are subject to change without notice. Prior to the purchase, please contact TOKIN for updated product data.
- Please request for a specification sheet for detailed product data prior to the purchase.
- Before using the product in this catalog, please read "Precautions" and other safety precautions listed in the printed version catalog.

## Contents

---

<b>Capacitors</b>	Polymer Tantalum Chip Capacitor NeoCapacitor™ .....	3
	125°C Rated Polymer Tantalum Chip Capacitor NeoCapacitor™ PS/H Series .....	4
	Face Down Package Polymer Chip Capacitor NeoCapacitor F/PS Series .....	5
	Axial Lead Type Aluminum Electrolytic Capacitor .....	6
	SuperCapacitor .....	7
	SuperCapacitor FMQ Series .....	8
	Micro Energy Harvesting .....	9
<b>Power Inductors</b>	Metal Composite Inductors for Automotive application .....	10
<b>Reactors</b>	Metal Composite Reactors .....	11
<b>Flex Suppressor®</b>	UL94 V-0 Flame Retardant type Flex Suppressor® .....	12
	High Magnetic Permeability type Flex Suppressor® .....	13
	GHz Band High Performance type Flex Suppressor® .....	14
<b>EMI Cores</b>	Nanocrystal EMI Core ESD-R-H-NC Series .....	15
<b>Choke Coils</b>	Three-phase SCF Series .....	17
	SSHB10HS Series .....	18
	SSHB21HS Series .....	19
	SSHB series Shapes and Dimensions .....	20
	SSRH24NV Series .....	21
	SSRH24NVS Series .....	22
	SSRH30NH Series .....	23
	SSRH7H-M Series .....	24
	SSRH7HS-M Series .....	25
<b>Sensor Actuator</b>	Current Sensor(Clamp CT : C/CT-1216) .....	26
	Thermal Sensor(TRS®Series&OHD™ Series) .....	27
	Pyroelectric Infrared Sensor (PL Series) .....	28
	Vibration Sensor .....	29
	Piezo Receiver / Speaker .....	30
	Multilayer Piezoelectric Actuators .....	31
	Piezoelectric Ceramics .....	32



- All specifications in this catalog and production status of products are subject to change without notice. Prior to the purchase, please contact TOKIN for updated product data.
- Please request for a specification sheet for detailed product data prior to the purchase.
- Before using the product in this catalog, please read "Precautions" and other safety precautions listed in the printed version catalog.

# Polymer Tantalum Chip Capacitor *NeoCapacitor*<sup>TM</sup>



## Features

- Low ESR / High permissible ripple current
- Industry leading lineup using cutting-edge powder technology
- No reduction in capacitance due to DC bias
- High level of safety

## Applications

- Notebook PC
- Tablet PC
- Smart Phone
- TV
- Security Camera
- HDD / SSD
- Digital Camera
- Server
- Base Station

## Product Lineup

Voltage Capacitance	2.5V	4V	6.3V	10V	16V	20V	25V	35V
3.3μF				A	A			
4.7μF				A	B2			
6.8μF			A	A, B2	B2		B3, B2	B3★
10μF		A	P2, A	P2, A, B2	B2		B15	
15μF			A, B2	A, B2	B2		B3★, B2	
22μF		B2	A, B3, B2	P2, A3, A, B3, B2		B2	B2★	
33μF		A	A, B3, B2	A3, A, B3, B2	B3★, B2	B2	V, D	
47μF		A, B3	P2, A3, A, B3, B2	A3, A, B3, B2	V, D	V15		
68μF		A	B3, B2	V, D	V, D			
100μF	A, B3	A3, A, B3, B2	A3, A, B3, B2	B2	V			
150μF		B2	B3★, B15, B2	V, D	D			
220μF	A, B3★, B2	B2	B2	V, D				
330μF	B2	V, D	V, D					
470μF	V	D	V, D					
680μF	D	D						
1000μF	D							

★ : New

シリーズ名	ケースコード	寸法 [mm]
G/PS	P2	2.0±0.1×1.25±0.1×0.9±0.1
F/PS	A3	3.2±0.2×1.6±0.2×0.9±0.1
PS/L	A	3.2±0.2×1.6±0.2×1.6±0.2
PS/L, F/PS	B3	3.5±0.2×2.8±0.2×1.1±0.1
PS/L	B15	3.5±0.2×2.8±0.2×1.4±0.1
PS/L	B2	3.5±0.2×2.8±0.2×1.9±0.1
PS/K	V15	7.3±0.3×4.3±0.3×1.4±0.1
PS/K	V	7.3±0.3×4.3±0.3×1.9±0.1
PS/K	D	7.3±0.3×4.3±0.3×2.8±0.3



- All specifications in this catalog and production status of products are subject to change without notice. Prior to the purchase, please contact TOKIN for updated product data.
- Please request for a specification sheet for detailed product data prior to the purchase.
- Before using the product in this catalog, please read "Precautions" and other safety precautions listed in the printed version catalog.



# 125°C Rated Polymer Tantalum Chip Capacitor

## NeoCapacitor™ PS/H Series



Highly reliable products optimized for industrial and communication devices which require reliability in high-temperature environments.

### Features

- Operation temperature range : -55°C~+125°C
- Achieve low ESR/high ripple current tolerance using conductive polymers

### Applications

- Server
- Base Station
- Communication Equipment
- LED Lighting
- Industrial Robot



### Product Lineup

Voltage/Capacitance	2.5V	6.3V	10V	16V	25V	35V
3.3μF						(B2)
4.7μF					(B2)	
22μF				(B2)		
33μF				(B2)		
47μF			B2			
100μF		B2				
150μF		(B2)				
220μF	(B2)	(B2)				
330μF	(B2)					

Series	Case code	Dimension [mm]
PS/H	B2	3.5±0.2×2.8±0.2×1.9±0.1

( ): Under development

### Frequency Characteristics

PSHB20J107M070 (B2/6.3V/100μF)

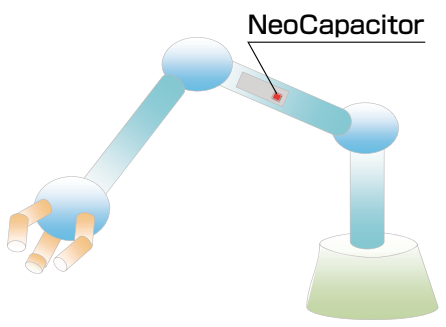
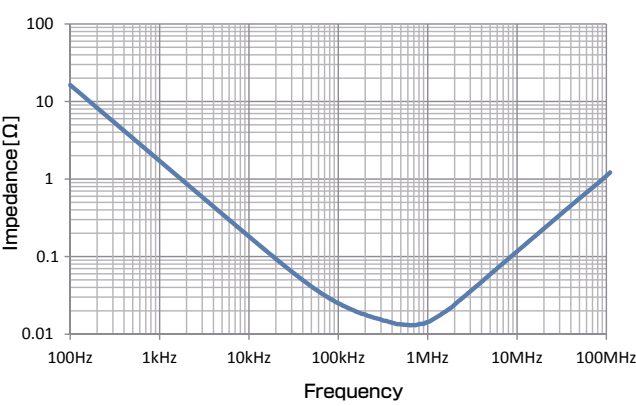

● All specifications in this catalog and production status of products are subject to change without notice. Prior to the purchase, please contact TOKIN for updated product data.  
 ● Please request for a specification sheet for detailed product data prior to the purchase.  
 ● Before using the product in this catalog, please read "Precautions" and other safety precautions listed in the printed version catalog.



# Face Down Package Polymer Chip Capacitor NeoCapacitor™ F/PS Series

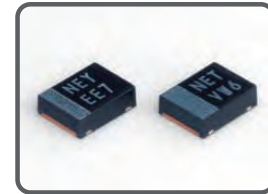

**A high reliability product suitable for lower profile and smaller motherboard footprint of notebook PCs pursuing high mobility.**

## Features

- Industry leading low profile and high capacity
- No reduction in capacitance due to DC bias
- No acoustic noise
- High level of safety

## Applications

- Notebook PC
- Tablet PC
- HDD/SSD
- IoT Equipment

## Product Lineup

Voltage \ Capacitance	2.5V	6.3V	10V	16V	25V	35V
6.8μF						B3
10μF					(A2)	
15μF					B3	
22μF			A3			
33μF			A3	(A3)		
47μF		A3	A3	(B3,A2)		
68μF			(B3)			
100μF		A3				
150μF		(A2)				
220μF		(B3)				
330μF	(B3)					

Series	Case code	Dimension [mm]
F/PS	A3	3.2±0.2×1.6±0.2×0.9±0.1
F/PS	A2	3.2±0.2×1.6±0.2×1.1±0.1
F/PS	B3	3.5±0.2×2.8±0.2×1.1±0.1

( ): Under development

## Construction

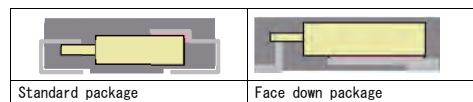

## Frequency Characteristics

Standard package : PSLB31E685M (B3/25V/6.8μF)  
Face down package : FPSB31V685M (B3/35V/6.8μF)

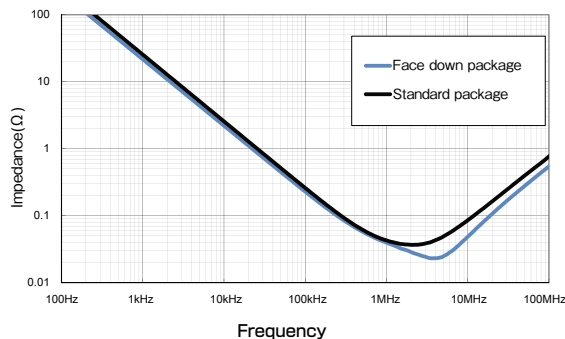

- All specifications in this catalog and production status of products are subject to change without notice. Prior to the purchase, please contact TOKIN for updated product data.
- Please request for a specification sheet for detailed product data prior to the purchase.
- Before using the product in this catalog, please read "Precautions" and other safety precautions listed in the printed version catalog.



# Axial Lead Type Aluminium Electrolytic Capacitor

## Features

Optimal for applications which require high-reliability, long lifetime.

- High temperature(150°C, Rated voltage, 2,000hours, PEG226 Series)
- High vibration resistance(20G)
- High permissible ripple current(Max.28Arms)
- AEC Q200 Compliant, produced in a ISO/TS 16949 certified factory

## Series development

Series	PEG225	PEG226
Diameter Length	16–20mm 26.5–42.5mm	16–20mm 26.5–42.5mm
Features	+150°C Reduce voltage 2,000hours High CV High permissible ripple current (Max. 28Arms) High vibration resistance	+150°C Reduce voltage 2,000hours High permissible ripple current (Max. 28Arms) High vibration resistance
Capacitance range	470–6300 μF	250–4700 μF
Rated voltage	25–63VDC	25–63VDC
operating temperature	–40~+125°C (+125~+150°C: Reduce voltage)	–40~+150°C

## Applications

### Automotive

- Cooling fan
- Water cooling pump
- Power steering
- Electric motorcycle/Electric scooter/EV
- Alternator
- Braking system
- Injection
- Valve control
- Idling stop
- Supercharger
- Active suspension



- All specifications in this catalog and production status of products are subject to change without notice. Prior to the purchase, please contact TOKIN for updated product data.
- Please request for a specification sheet for detailed product data prior to the purchase.
- Before using the product in this catalog, please read "Precautions" and other safety precautions listed in the printed version catalog.

# SuperCapacitor

The SuperCapacitor is a capacitor that employs the electric double layer principle to achieve an extremely large capacitance. It is ideal for backups requiring long life and high reliability.

## Principle of Electrical Double Layer

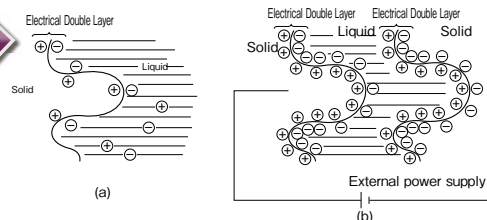

$$C = \epsilon \epsilon_0 (4\pi \delta)^{-1} dS$$

$\epsilon$  : Dielectric constant of electrolyte  
 $\delta$  : Distance from the electrode surface to the center of ion, which corresponds to a thickness of the electric double layer  
 $S$  : Surface area of the electrode interface

## Features

- There is no limit for charge/discharge cycles. In principle, it has an unlimited cycle life.
- Since no chemical charge is involved, unlike a battery, quick charging and discharging is possible. Full charge is possible within a few seconds.
- General failure mode of SuperCapacitor is open circuit.
- Lineup matching various mounting form is available. Surface mounting and automatic mounting (self-alone mold type) can be applied.
- We guarantee a wide operating temperature range. High reliability type : -40 to 85°C
- RoHS Compliant

## Applications and Markets

Since the TOKIN SuperCapacitor displays high structural reliability in humid environments and failure mode occurs in open circuits, they are widely used for data and clock backup, and other applications requiring high reliability, such as in infrastructure, traffic, automobiles, etc.

## Lineup

• $\mu$ A order applications			
<b>FR</b> 5.5V	<b>FGR</b> 5.5V	High temperature guarantee (85°C)	<b>FM</b> FMR type 5.5V
<b>FG</b> 3.5 V to 5.5V	<b>FGH</b> 3.5 V to 5.5V		Automatic assembly type 3.6V-High reliability
		Low profile	<b>FMR 0V type</b> 3.6V-85°C
			<b>FCS</b> 3.5 V to 5.5V
• mA order applications			
<b>FT</b> 5.5V	<b>FS</b> 5.5 V to 12V	Compact High temperature type 85°C	<b>FMS</b> 5.5V
			Adoption of high reliability molding



- All specifications in this catalog and production status of products are subject to change without notice. Prior to the purchase, please contact TOKIN for updated product data.
- Please request for a specification sheet for detailed product data prior to the purchase.
- Before using the product in this catalog, please read "Precautions" and other safety precautions listed in the printed version catalog.



# SuperCapacitor FMQ Series (Resin molded, Low ESR Type)

## Features

- ☆Low ESR
  - Most suitable for peak assisting, and backup for clock
- ☆High reliability
  - Reliability is maintained even in high temperature and high humidity environment
    - : 85°C-85%RH-5.5V, 500h guaranteed
  - World's first capacitor usable at high temperature environment of +105°C
    - : 105°C-5.5V, 500h (actual value)



## Dimensions

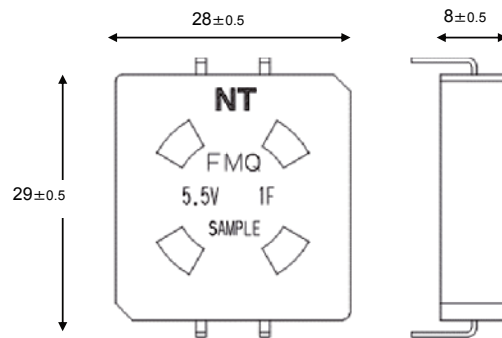

## Specifications

Rated voltage [Vdc]	ESR [ $\Omega$ ]	Nominal capacitance (Discharge system) [F]	Current at 30min. [mA]
5.5	1.0	1.0+80/-20%	1.5

※Category temperature: -40 ~ +105°C



- All specifications in this catalog and production status of products are subject to change without notice. Prior to the purchase, please contact TOKIN for updated product data.
- Please request for a specification sheet for detailed product data prior to the purchase.
- Before using the product in this catalog, please read "Precautions" and other safety precautions listed in the printed version catalog.



# Micro Energy Harvesting - MEH

## Merit of MEH: Maintenance free/self-supporting power supply

### Merit 1 · Compact and High Convenience

- Module is compact, palm-sized.
- Each unit is replaceable to cartridge type.

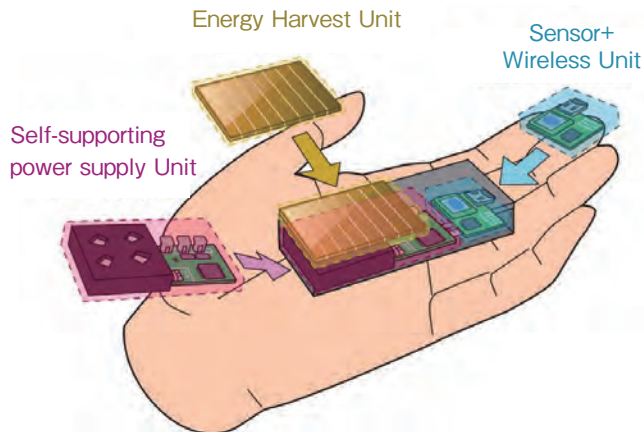

### Merit 2 · Possible Expansion of the Storage Capacity

- MEH module with built-in SuperCapacitor can be easily consolidated, it is possible to expand the capacity of the storage according to the application.

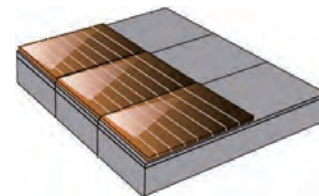

### Merit 3 · Unnecessary Battery Replacement

- Build maintenance free power supply by using several energy harvesting sources and SuperCapacitor that is without deterioration in charge/discharge cycle.

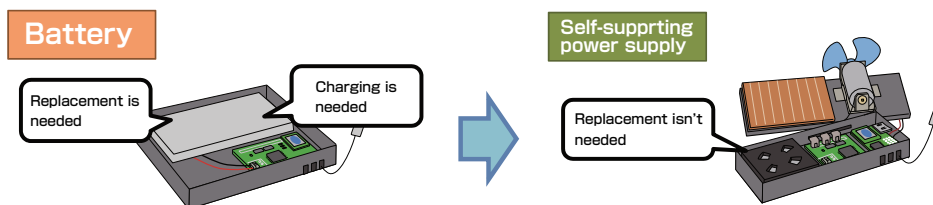

# Metal Composite Inductors for Automotive application



## Features

- Operating temperature range: **-40°C to +150°C**  
 (Include self temperature rise)
- AEC-Q200
- High reliability products (Automotive Market)
- Shielded construction, Large current, Low DCR
- Pb-free, RoHS Compliant

## Applications

- Inductor for ECU (Automotive)  
 (EPS, LED Head Light, SRS)

## Product line up

Series	Inductance ( $\mu$ H ) At 100kHz, 1mA	I <sub>rms</sub> *1 ( A )	I <sub>sat</sub> *2 ( A )
MPLCV0645L100	10±20%	4.0	6.5
MPLCV0654L4R7	4.7±20%	6.3	10.5
MPLCV0654L330	33±20%	2.6	4.0
MPLCV0654L470	47±20%	2.1	3.0
MPLCV1054L100	10±20%	7.1	12.0
MPLCV1054L220	22±20%	5.5	7.0

\*1 40°C rise at rated current. \*2 Inductance drop 30%.

● Operating temperature range : -40°C to +150°C(Include self temperature rise), AEC-Q200

## Dimensions

- MPLCV0645 Series
- MPLCV0654 Series

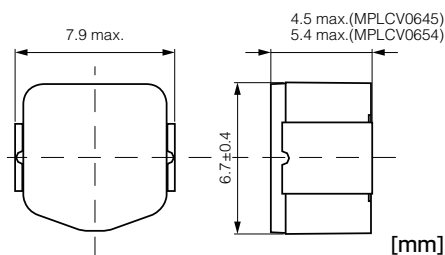

- MPLCV1054 Series

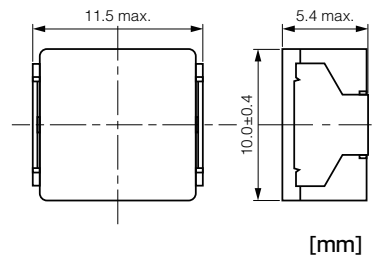

- All specifications in this catalog and production status of products are subject to change without notice. Prior to the purchase, please contact TOKIN for updated product data.
- Please request for a specification sheet for detailed product data prior to the purchase.
- Before using the product in this catalog, please read "Precautions" and other safety precautions listed in the printed version catalog.

Custom Product

# Metal Composite Reactors

## Features

- Integrally molded reactor by inject molding of our original technology
- Superior design flexibility by inject molding method
- Leakage flux is small due to have a distributed gap
- Excellent heat dissipation efficiency by integral molding
- Able to support a high-frequency (50kHz or less)

## Applications

- Inverter for HEV/PHEV
- Power conditioner

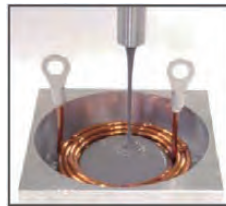

【Injection process】

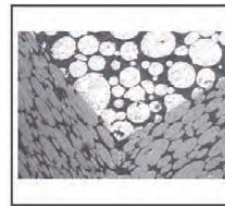

【Cross-section of core】

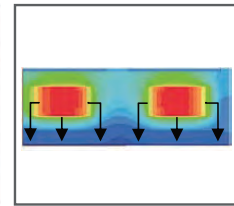

【Thermal analysis】  
 Example; heat radiation to the bottom

## Specification example

### Low height type

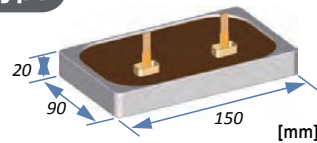

### Standard type

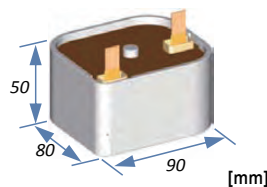

### Large size

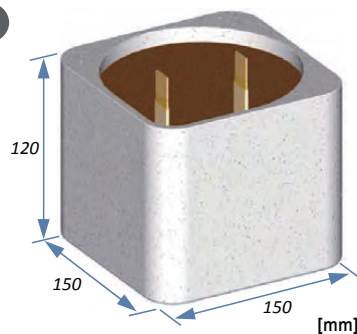

## Characteristics (typ.)

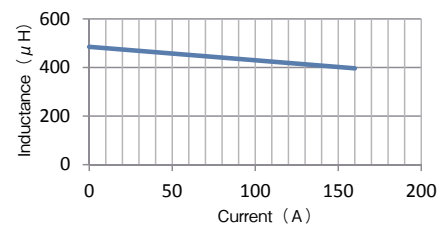
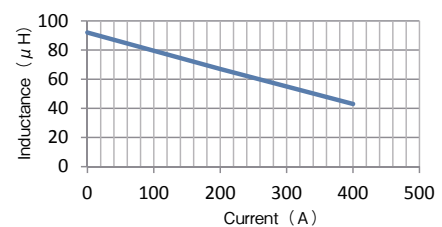
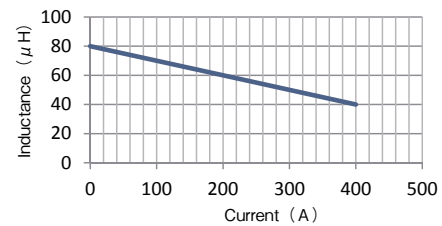

- All specifications in this catalog and production status of products are subject to change without notice. Prior to the purchase, please contact TOKIN for updated product data.
- Please request for a specification sheet for detailed product data prior to the purchase.
- Before using the product in this catalog, please read "Precautions" and other safety precautions listed in the printed version catalog.



# UL94 V-0 Flame Retardant type Flex Suppressor®

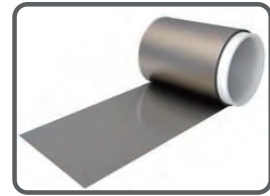

## Features

- Lowered impact to the environment, Halogen free
- UL94 V-0
- EFA :  $\mu$ 60 permeability, Roll acceptable, **Red phosphorus free**
- FF1 :  $\mu$ 100 permeability, **Supports Roll up to 0.3mm, AEC-Q200**
- EFF4:  $\mu$ 140 permeability, **AEC-Q200**

## Applications

- Noise radiation suppression, Internal interference suppression
- Anti-ESD measure for electric devices.

## Specifications

Features	Red phosphorus free type	NEW Roll type	NEW High $\mu$ type
Type	EFA	FF1	EFF4
Effective frequency	Up to 10GHz		
Operating temperature (°C)	-40 to +105		
Thickness (mm)	0.05/0.1/0.2/0.3		0.1/0.2/0.3/0.5
Standard dimensions (mm)	240×240 / Roll acceptable		240×240
Specific gravity	3.1 (typ.)		3.7 (typ.)
Approved standard	UL94 V-0 (UL File No.E176124)		
Environment	RoHS compliant, Halogen free / PVC free / Lead free		
	Red phosphorus free	-	
Relative magnetic permeability(at 3MHz)	60(typ.)	100(typ.)	140(typ.)

## Permeability characteristics

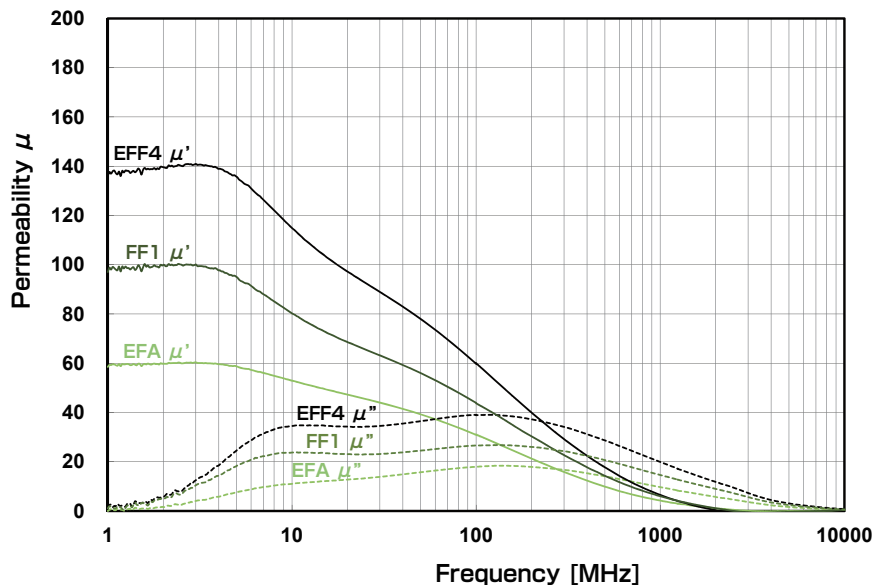

\*Above data are not guaranteed values.



- All specifications in this catalog and production status of products are subject to change without notice. Prior to the purchase, please contact TOKIN for updated product data.
- Please request for a specification sheet for detailed product data prior to the purchase.
- Before using the product in this catalog, please read "Precautions" and other safety precautions listed in the printed version catalog.



# High Magnetic Permeability type Flex Suppressor<sup>®</sup>

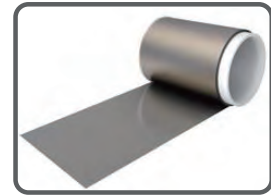

## Features

- Lowered impact to the environment, Halogen free
- Red phosphorus free
- UL94 HB
- FX5 :  $\mu$  150 permeability, Roll acceptable
- EFX6 :  $\mu$  160 permeability

## Applications

- Noise radiation suppression, Internal interference suppression
- Anti-ESD measure for electric devices.

## Specifications

Features	Ultra thin, Roll type <span style="color:red">NEW</span>	High $\mu$ type <span style="color:red">NEW</span>
Type	FX5	EFX6
Effective frequency	Up to 10GHz	
Operating temperature (C)	-40 to +105	
Thickness (mm)	0.025/0.05/0.075	0.1/0.2/0.3
Standard dimensions (mm)	240x240 / Roll acceptable	240x240
Specific gravity	3.3(typ.)	3.8(typ.)
Approved standard	UL94 HB (UL File No.E176124)	
Environment	RoHS compliant, Halogen free / PVC free / Lead free Red phosphorus free	
Relative magnetic permeability(at 3MHz)	150(typ.)	160(typ.)

## Permeability characteristics

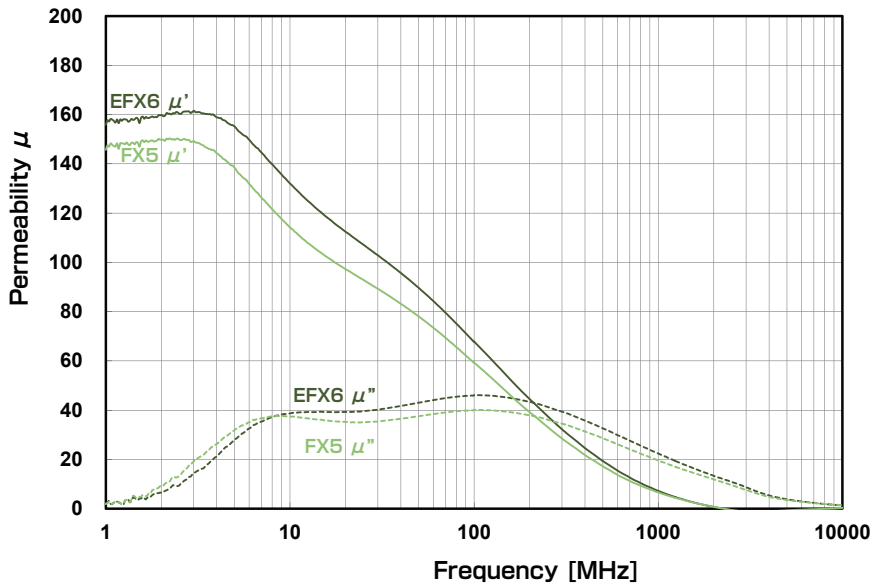

\*Above data are not guaranteed values.



- All specifications in this catalog and production status of products are subject to change without notice. Prior to the purchase, please contact TOKIN for updated product data.
- Please request for a specification sheet for detailed product data prior to the purchase.
- Before using the product in this catalog, please read "Precautions" and other safety precautions listed in the printed version catalog.



# GHz band High Performance type Flex Suppressor®



## Features

- Lowered impact to the environment, Halogen free
- Red phosphorus free
- UL94 HB
- FG1 : Roll acceptable
- EFG2 : Excellent suppression of high frequency noise

## Applications

- Measures for the desense LTE, Wi-Fi, GPS, etc.

## Specifications

Features	Ultra thin, Roll type <span style="color:red">NEW</span>	High performance type <span style="color:red">NEW</span>
Type	FG1	EFG2
Effective frequency	1GHz to 10GHz	
Operating temperature (°C)	-40 to +105	
Thickness (mm)	0.025/0.05/0.075	0.1/0.2/0.3
Standard dimensions (mm)	240x240 / Roll acceptable	240x240
Specific gravity	3.1 (typ.)	3.9 (typ.)
Approved standard	UL94 HB (UL File No.E176124)	
Environment	RoHS compliant, Halogen free / PVC free / Lead free Red phosphorus free	
Relative magnetic permeability (at 3MHz)	25 (typ.)	35 (typ.)

## Permeability characteristics

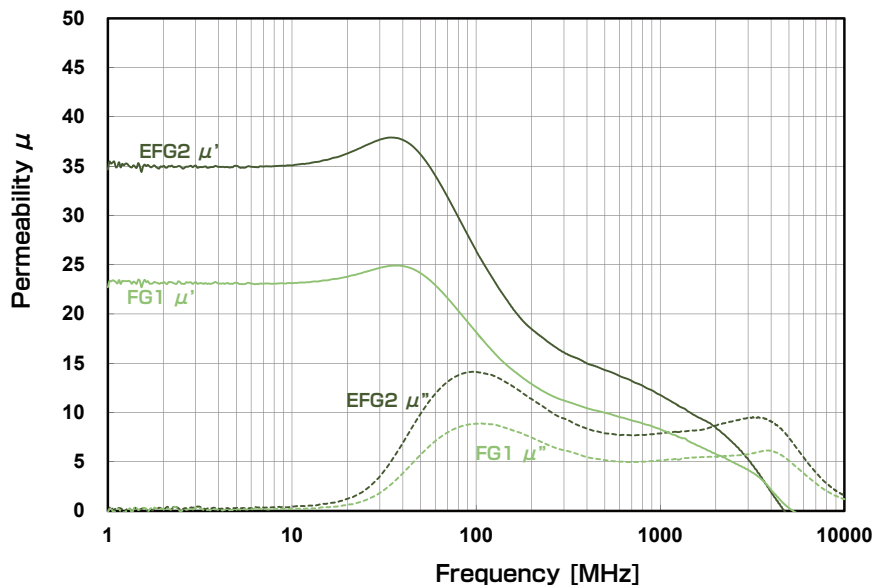

\*Above data are not guaranteed values.



- All specifications in this catalog and production status of products are subject to change without notice. Prior to the purchase, please contact TOKIN for updated product data.
- Please request for a specification sheet for detailed product data prior to the purchase.
- Before using the product in this catalog, please read "Precautions" and other safety precautions listed in the printed version catalog.



# Nanocrystal EMI Core ESD-R-H-NC Series

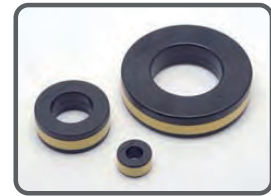

## Features

- Suppresses radiation and conduction noise in wide frequency range
- Ring type: Correspondence from small diameter to large diameter
- Operating temperature range:  $-40^{\circ}\text{C}\sim+120^{\circ}\text{C}$
- Frame retardant: UL94 V-0

## Applications

- General purpose inverters
- Air conditioners
- Multifunction printers for business use
- Industrial equipments

## Dimensions

※ Custom design available

Model	Dimensions (mm)		
	A	B	C
ESD-R-291216H-NC23	29.0	12.7	16.0
ESD-R-341616H-NC23	34.0	16.5	16.0
ESD-R-421617H-NC23	42.0	16.7	17.0
ESD-R-512936H-NC23	51.0	29.5	36.0
ESD-R-512419H-NC23	51.0	24.4	19.0
ESD-R-613325H-NC23	61.0	33.2	25.0
ESD-R-854626H-NC23	85.0	46.0	26.0
ESD-R-1105826H-NC23	110.0	58.5	26.0
ESD-R-1469637H-NC23	146.0	96.0	37.0
ESD-R-20515636H-NC23	205.0	156.0	36.0

※ This series still in the development stage. Changes may be make at the start of mass production.  
 ※ The series with a base is also under development. Please contact TOKIN for details.

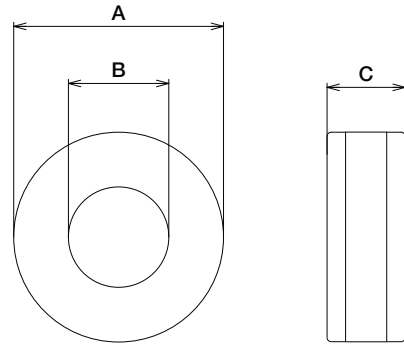

## Impedance Characteristics (Typ. value)

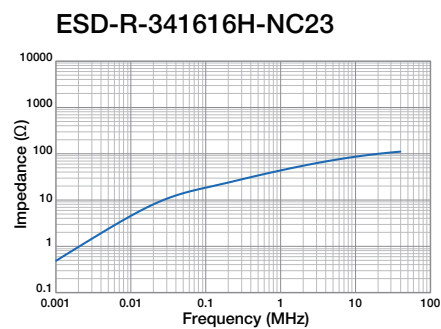
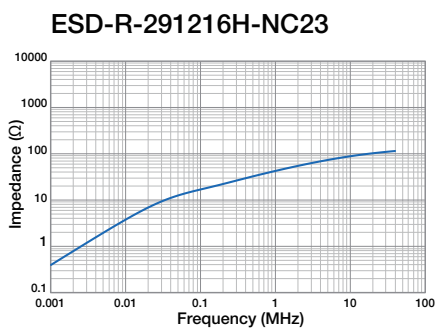

※ This product is under development and design might be changed.



- All specifications in this catalog and production status of products are subject to change without notice. Prior to the purchase, please contact TOKIN for updated product data.
- Please request for a specification sheet for detailed product data prior to the purchase.
- Before using the product in this catalog, please read "Precautions" and other safety precautions listed in the printed version catalog.

**ESD-R-421617H-NC23**

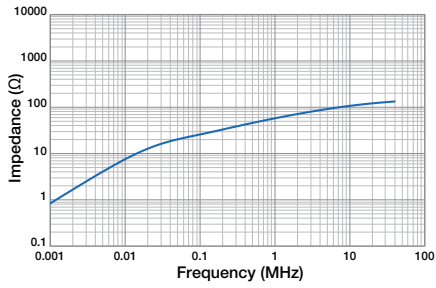

**ESD-R-512936H-NC23**

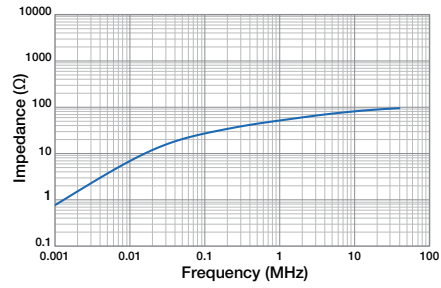

**ESD-R-512419H-NC23**

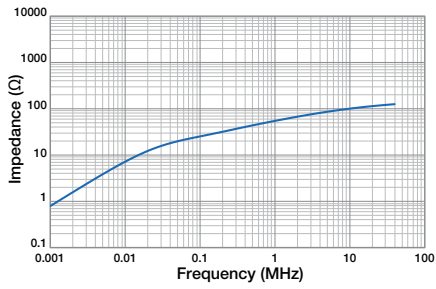

**ESD-R-613325H-NC23**

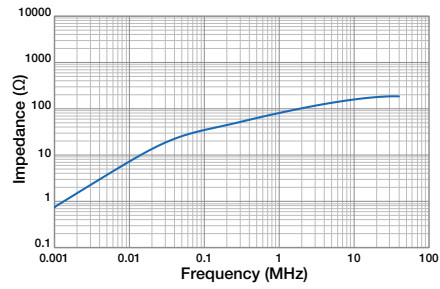

**ESD-R-854626H-NC23**

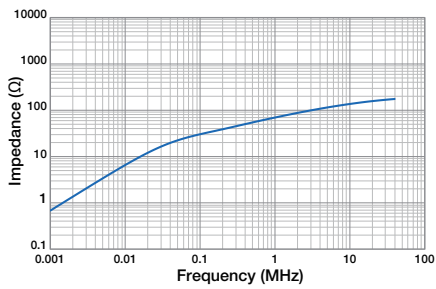

**ESD-R-1105826H-NC23**

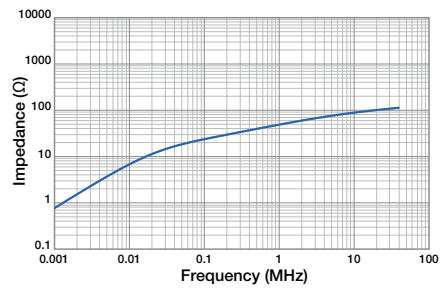

**ESD-R-1469637H-NC23**

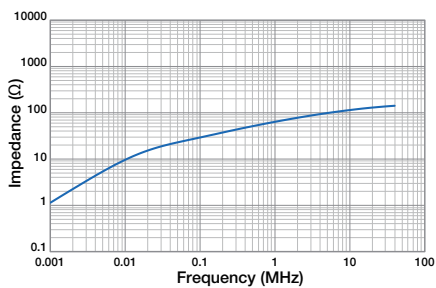

**ESD-R-20515636H-NC23**

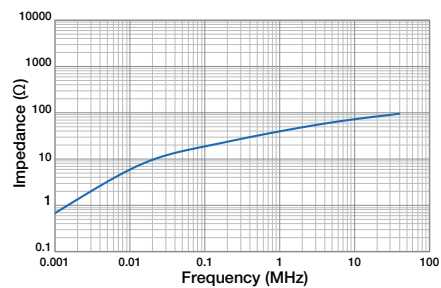

※This product is under development and design might be changed.



- All specifications in this catalog and production status of products are subject to change without notice. Prior to the purchase, please contact TOKIN for updated product data.
- Please request for a specification sheet for detailed product data prior to the purchase.
- Before using the product in this catalog, please read "Precautions" and other safety precautions listed in the printed version catalog.



Custom  
Product

# Three-phase SCF Series

## Features

- High current series (up to 60A)
- Rated voltage 500V correspondence
- Operating temperature ~120°C, UL94 V-0
- Metal-based magnetic materials are employed

## Applications

- Air conditioner
- Power conditioner
- Industrial equipment with inverter

## Specification

Part number	Core size	Rated current (A)	Inductance (mH) Min.	DC resistance (mΩ/line) Max.	Input and output terminal
SCF38B - 250 - S2R3A004J/JH	FR38	25	0.4	1.8	on-board mount
SCF47B - 300 - S1R7C010J/JH	FR47	30	1.0	2.5	on-board mount
SCF56B - 400 - S2R3A035J/JH	FR56	40	3.5	4.5	on-board mount
3 Phase 4 line SCF Series	FR38~68	15/20/30/60	0.4~4.0	0.3~6.0	on-board mount terminal connecting board assembly type

## Dimensions

**3 Phase SCF (vertical)**



**3 Phase SCF (horizontal)**



**3 Phase 4 line SCF (on-board mount)**



**3 Phase 4 line SCF (terminal connecting)**



- All specifications in this catalog and production status of products are subject to change without notice. Prior to the purchase, please contact TOKIN for updated product data.
- Please request for a specification sheet for detailed product data prior to the purchase.
- Before using the product in this catalog, please read "Precautions" and other safety precautions listed in the printed version catalog.

# NEW SSHB10HS Series



## Features

- Hybrid coil capable of simultaneously suppressing common and normal noises with one coil
- Unique core molding technology and materials development realizes quiet operation and excellent superimposition characteristics at high temperature
- Class B (130°C) support

## Applications

- LED lighting
- AV equipment
- OA equipment
- Power supply

## Specification

※ Custom design available

Part number	Rated current (A)	Inductance [common] (mH)Min.	Inductance [normal] (μH)Typ.	Wire size (mmφ)	DC resistance(Ω/line) Typ.
SSHB10HS-04265	0.4	26.5	949	0.20	2.269
SSHB10HS-05177	0.5	17.7	635	0.23	1.436
SSHB10HS-06140	0.6	14.0	502	0.25	1.087
SSHB10HS-07099	0.7	9.9	353	0.28	1.736
SSHB10HS-08068	0.8	6.8	243	0.30	0.519
SSHB10HS-10051	1.0	5.1	185	0.32	0.404
SSHB10HS-11043	1.1	4.3	154	0.35	0.313
SSHB10HS-13030	1.3	3.0	108	0.37	0.232
SSHB10HS-17019	1.7	1.9	71	0.40	0.157
SSHB10HS-22011	2.2	1.1	41	0.45	0.094
SSHB10HS-30006	3.0	0.6	23	0.50	0.059

## Impedance Characteristics

### Common mode

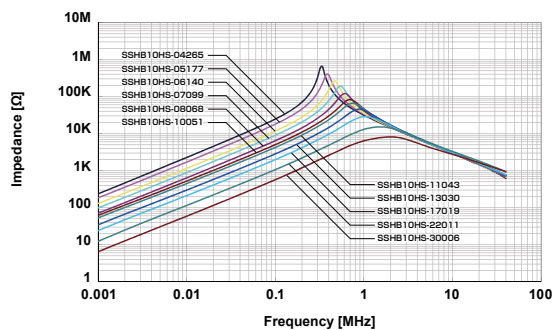

### Normal mode

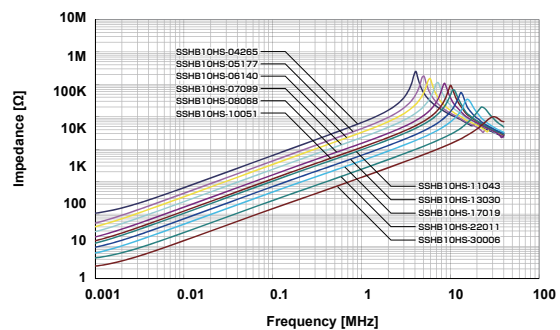

- All specifications in this catalog and production status of products are subject to change without notice. Prior to the purchase, please contact TOKIN for updated product data.
- Please request for a specification sheet for detailed product data prior to the purchase.
- Before using the product in this catalog, please read "Precautions" and other safety precautions listed in the printed version catalog.

# NEW SSHB21HS Series



## Features

- Hybrid coil capable of simultaneously suppressing common and normal noises with one coil
- Unique core molding technology and materials development realizes quiet operation and excellent superimposition characteristics at high temperature
- Class B (130°C) support

## Applications

- LED lighting
- AV equipment
- OA equipment
- Power supply

## Specification

※ Custom design available

Part number	Rated current (A)	Inductance [common] (mH)Min.	Inductance [normal] (μH)Typ.	Wire size (mm φ)	DC resistance (Ω/line) Typ.
SSHB21HS-03656	0.3	65.6	1819	0.20	2.609
SSHB21HS-04507	0.4	50.7	1407	0.23	1.820
SSHB21HS-05440	0.5	44.0	1221	0.23	1.695
SSHB21HS-06378	0.6	37.8	1048	0.25	1.328
SSHB21HS-07267	0.7	26.7	742	0.28	0.902
SSHB21HS-08200	0.8	20.0	559	0.30	0.672
SSHB21HS-10145	1.0	14.5	402	0.32	0.501
SSHB21HS-12110	1.2	11.0	305	0.35	0.364
SSHB21HS-15064	1.5	6.4	178	0.37	0.241
SSHB21HS-18046	1.8	4.6	128	0.40	0.178
SSHB21HS-20034	2.0	3.4	95	0.45	0.130
SSHB21HS-25021	2.5	2.1	59	0.50	0.079
SSHB21HS-30013	3.0	1.3	38	0.55	0.051

## Impedance Characteristics

### Common mode

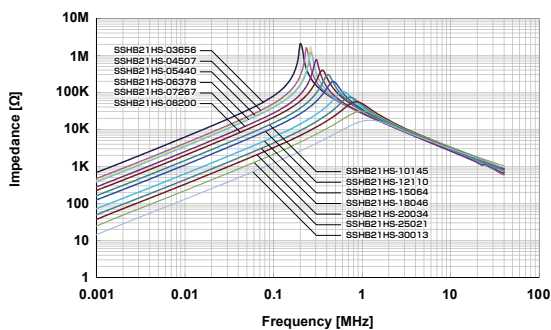

### Normal mode

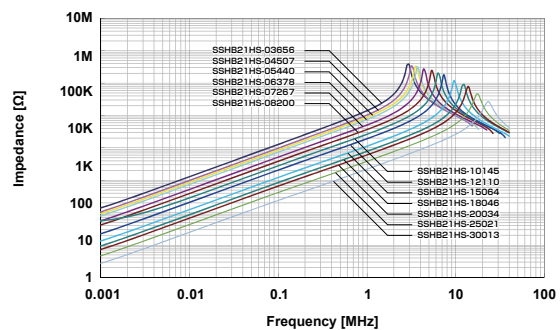

- All specifications in this catalog and production status of products are subject to change without notice. Prior to the purchase, please contact TOKIN for updated product data.
- Please request for a specification sheet for detailed product data prior to the purchase.
- Before using the product in this catalog, please read "Precautions" and other safety precautions listed in the printed version catalog.

**NEW**

# SSHB Series Shapes and Dimensions

**SSHB10HS**

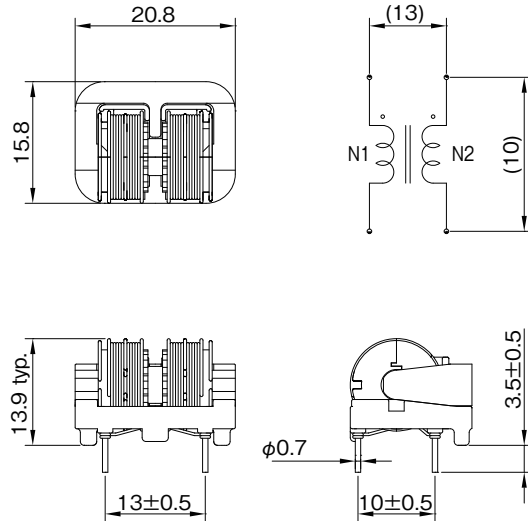

[mm]

**SSHB21HS**

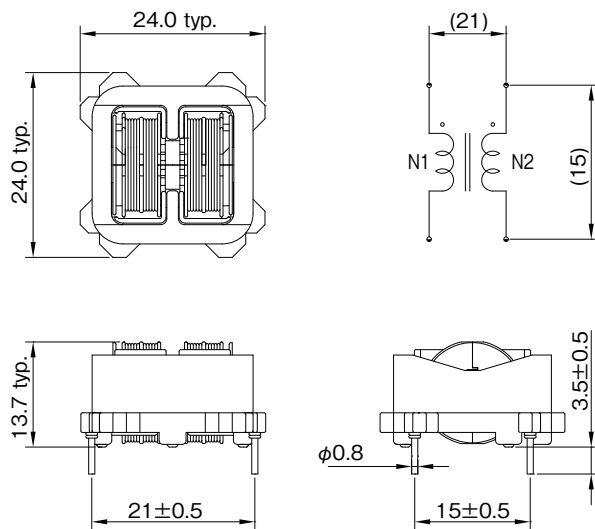

[mm]



- All specifications in this catalog and production status of products are subject to change without notice. Prior to the purchase, please contact TOKIN for updated product data.
- Please request for a specification sheet for detailed product data prior to the purchase.
- Before using the product in this catalog, please read "Precautions" and other safety precautions listed in the printed version catalog.

# NEW SSRH24NV Series



## Features

Using high magnetic permeability material S18H optimized core and structure

- Downsized(30% less volume than SS28V Series)
- Expanded current range  
(SS28V Series: up to 2.5A → New product: up to 5A)
- Realized high performance, low Rdc(Compared to SS28V Series, Inductance: 2 times or more, Rdc: 3% or greater reduction)
- Non-split bobbin design for ultra-high impedance characteristics

## Applications

- AV equipment
- OA equipment
- Digital appliance
- Power supply

## Specification

※Custom design available

Part number	Rated current (A)	Inductance (mH) Min.	DC resistance (Ω/line) Max.	Temperature rise (K) Max.
SSRH24NV-12655	1.2	65.5	0.475	65
SSRH24NV-16470	1.6	47	0.327	65
SSRH24NV-20310	2.0	31	0.214	65
SSRH24NV-25205	2.5	20.5	0.145	65
SSRH24NV-30145	3.0	14.5	0.102	65
SSRH24NV-35086	3.5	8.6	0.078	65
SSRH24NV-40069	4.0	6.9	0.057	65
SSRH24NV-45059	4.5	5.9	0.048	65
SSRH24NV-50041	5.0	4.1	0.035	65

## Dimensions

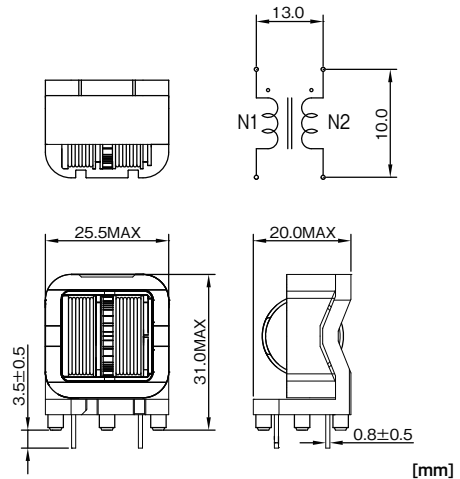

## Impedance Characteristics

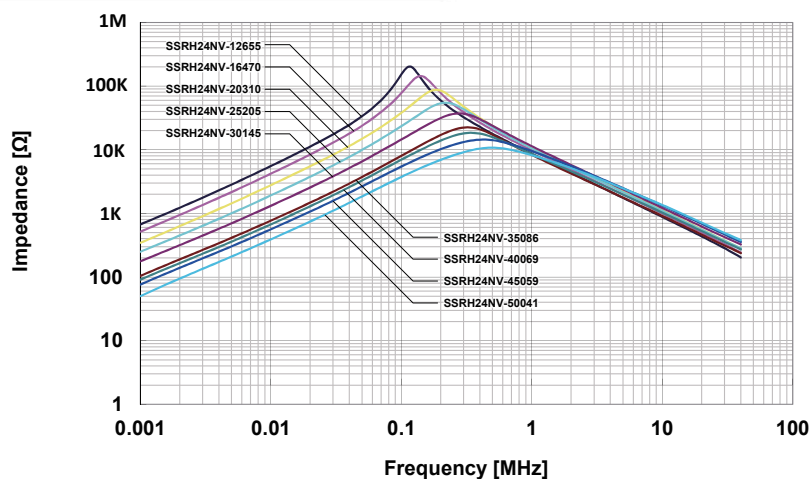

- All specifications in this catalog and production status of products are subject to change without notice. Prior to the purchase, please contact TOKIN for updated product data.
- Please request for a specification sheet for detailed product data prior to the purchase.
- Before using the product in this catalog, please read "Precautions" and other safety precautions listed in the printed version catalog.

# NEW SSRH24NVS Series



## Features

Using high magnetic permeability material S18H optimized core and structure

- Downsized(30% less volume than SS28V Series)
- Expanded current range  
(SS28V Series: up to 2.5A → New product: up to 5A)
- Realized high performance, low Rdc(Compared to SS28V Series, Inductance: 1.6 times or more, Rdc: 20% or greater reduction)
- Split bobbin design for wideband impedance characteristics

## Applications

- AV equipment
- OA equipment
- Digital appliance
- Power supply

## Specification

※ Custom design available

Part number	Rated current (A)	Inductance (mH) Min.	DC resistance (Ω/line) Max.	Temperature rise (K) Max.
SSRH24NVS-12500	1.2	50	0.430	65
SSRH24NVS-16320	1.6	32	0.265	65
SSRH24NVS-20215	2.0	21.5	0.177	65
SSRH24NVS-25130	2.5	13	0.111	65
SSRH24NVS-30092	3.0	9.2	0.079	65
SSRH24NVS-35080	3.5	8	0.074	65
SSRH24NVS-40059	4.0	5.9	0.055	65
SSRH24NVS-45041	4.5	4.1	0.041	65
SSRH24NVS-50026	5.0	2.6	0.027	65

## Dimensions

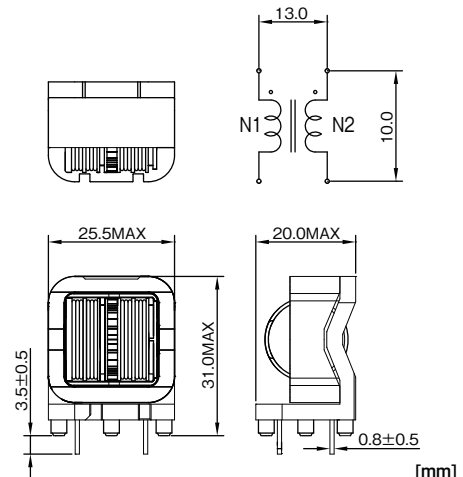

## Impedance Characteristics

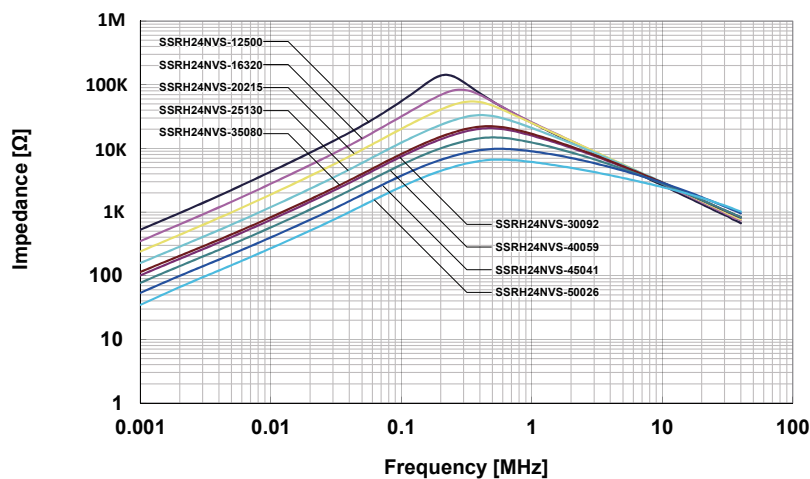

- All specifications in this catalog and production status of products are subject to change without notice. Prior to the purchase, please contact TOKIN for updated product data.
- Please request for a specification sheet for detailed product data prior to the purchase.
- Before using the product in this catalog, please read "Precautions" and other safety precautions listed in the printed version catalog.



# SSRH30NH Series



## Features

- Using high magnetic permeability material S18H optimized core and structure  
High inductance characteristics as toroid core (equivalent to SC type)
- High current series (up to  $\phi 1.3$ , up to 10A)

## Applications

- AV equipment
- OA equipment
- Digital appliance
- Power supply

## Specification

※ Custom design available

Part number	Rated current (A)	Inductance (mH) Min.	DC resistance ( $\Omega$ /line) Max.	Wire size (mm $\phi$ )
SSRH30NH-50100	5	10	0.053	0.85
SSRH30NH-60050	6	5.0	0.028	0.95
SSRH30NH-70040	7	4.0	0.023	1.0
SSRH30NH-80029	8	2.9	0.0165	1.1
SSRH30NH-90026	9	2.6	0.0135	1.2
SSRH30NH-100020	10	2.0	0.010	1.3

## Dimensions

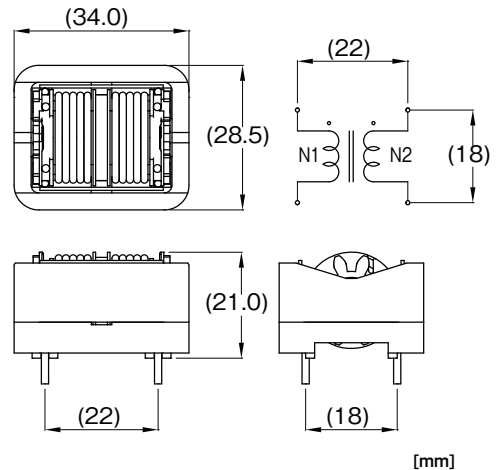

## Impedance Characteristics

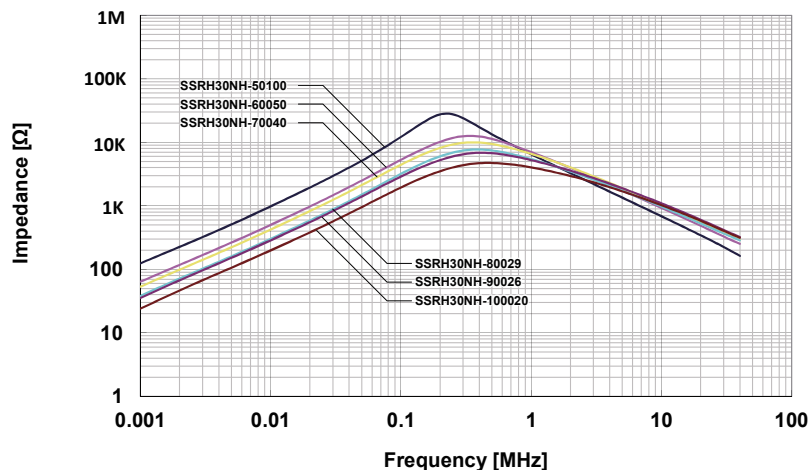

※ This product is under development and design might be changed.



- All specifications in this catalog and production status of products are subject to change without notice. Prior to the purchase, please contact TOKIN for updated product data.
- Please request for a specification sheet for detailed product data prior to the purchase.
- Before using the product in this catalog, please read "Precautions" and other safety precautions listed in the printed version catalog.



# NEW SSRH7H-M Series

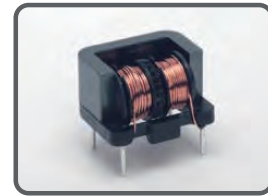

## Features

- Smallest-in-industry gear common choke for low current applications
- High performance and reduced size through use of high magnetic permeability material S18H and optimization of the core shape and product structure (Compared to SU10VFC Series, Inductance: 1.6 times or more, Volume: 35% less)
- Non-split bobbin design for ultra-high impedance characteristics

## Applications

- AV equipment
- OA equipment
- Digital appliance
- Compact power supply

## Specification

※ Custom design available

Model	Rated current (A)	Inductance (mH) Min.	DC resistance (Ω/line) Max.	Wire size (mm φ)	Temperature rise Max.
SSRH7H-M031157	0.3	115.7	3.57	0.16	55
SSRH7H-M04596	0.4	59.6	2.02	0.18	55
SSRH7H-M05408	0.5	40.8	1.36	0.20	55
SSRH7H-M06237	0.6	23.7	0.78	0.23	55
SSRH7H-M07196	0.7	19.6	0.71	0.23	55
SSRH7H-M08169	0.8	16.9	0.56	0.25	55
SSRH7H-M10108	1.0	10.8	0.36	0.28	55
SSRH7H-M11081	1.1	8.1	0.27	0.30	55
SSRH7H-M13064	1.3	6.4	0.21	0.32	55
SSRH7H-M15043	1.5	4.3	0.14	0.35	55
SSRH7H-M17029	1.7	2.9	0.12	0.35	55
SSRH7H-M20016	2.0	1.6	0.09	0.35	55

## Impedance Characteristics

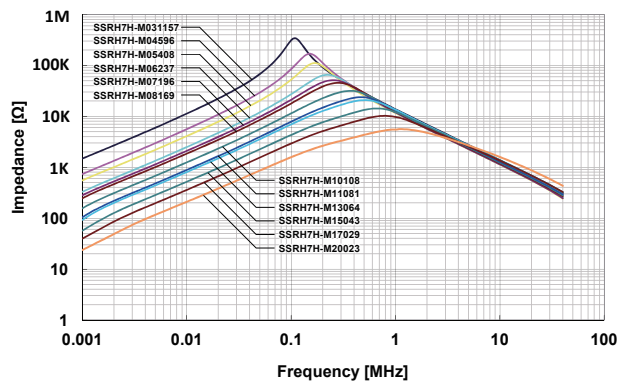

## Dimensions

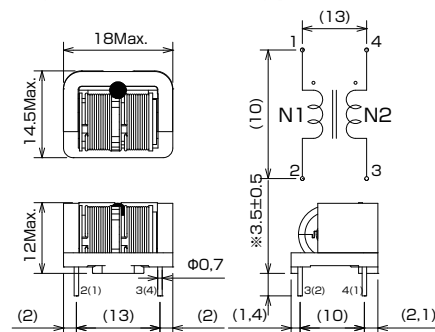

- All specifications in this catalog and production status of products are subject to change without notice. Prior to the purchase, please contact TOKIN for updated product data.
- Please request for a specification sheet for detailed product data prior to the purchase.
- Before using the product in this catalog, please read "Precautions" and other safety precautions listed in the printed version catalog.



# NEW SSRH7HS-M Series

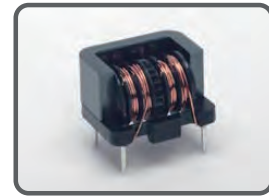

## Features

- Smallest-in-industry gear common choke for low current applications
- High performance and reduced size through use of high magnetic permeability material S18H and optimization of the core shape and product structure (Compared to SU10VFC Series, Inductance: 1.3 times or more, Volume: 35% less)
- Split bobbin design for wideband impedance characteristics

## Applications

- AV equipment
- OA equipment
- Digital appliance
- Compact power supply

## Specification

※ Custom design available

Model	Rated current (A)	Inductance (mH) Min.	DC resistance (Ω/line) Max.	Wire size (mm φ)	Temperature rise Max.
SSRH7HS-M03925	0.3	92.5	3.18	0.16	50
SSRH7HS-M04467	0.4	46.7	1.79	0.18	50
SSRH7HS-M05324	0.5	32.4	1.21	0.20	50
SSRH7HS-M06185	0.6	18.5	0.69	0.23	50
SSRH7HS-M07154	0.7	15.4	0.63	0.23	50
SSRH7HS-M08134	0.8	13.4	0.50	0.25	50
SSRH7HS-M10084	1.0	8.4	0.32	0.28	50
SSRH7HS-M11064	1.1	6.4	0.24	0.30	50
SSRH7HS-M13046	1.3	4.6	0.18	0.32	50
SSRH7HS-M15036	1.5	3.6	0.13	0.35	50
SSRH7HS-M17023	1.7	2.3	0.1	0.35	50
SSRH7HS-M20013	2.0	1.3	0.08	0.35	50

## Impedance Characteristics

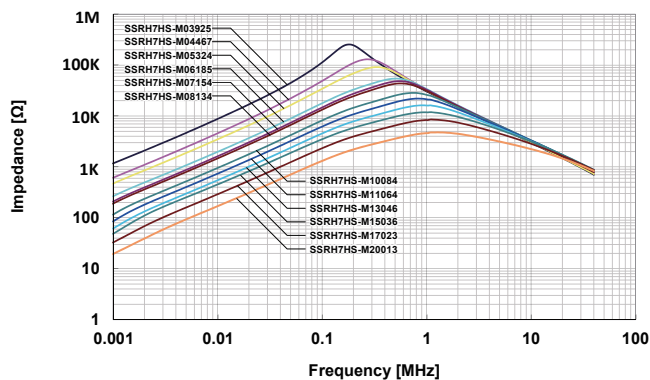

## Dimensions

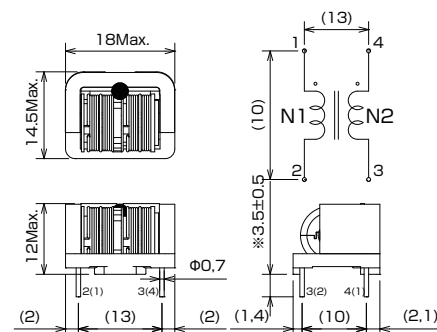

- All specifications in this catalog and production status of products are subject to change without notice. Prior to the purchase, please contact TOKIN for updated product data.
- Please request for a specification sheet for detailed product data prior to the purchase.
- Before using the product in this catalog, please read "Precautions" and other safety precautions listed in the printed version catalog.

# Current Sensor (Clamp CT: C/CT-1216)



**Sensors based on proprietary materials that contribute to energy saving.**

## Features

- New design structure . Improved ratio error characteristics(50% reduction from existing model)
- Flat temperature characteristics by original core material
- Compact & Slim design
- Noncombustible

## Applications

- xEMS Measurements (Power monitoring)
- Power conditioners, Inverter units
- Distribution boards
- Power monitoring system

## Dimensions

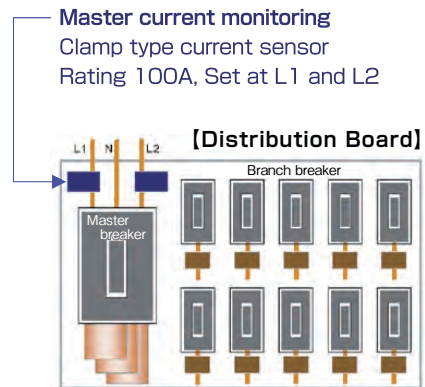
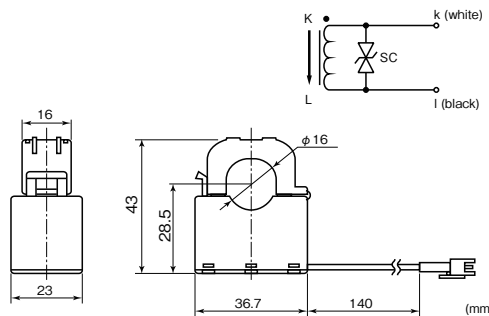

## Specifications

Items	Unit	STD	Condition
Rated primary current	Arms	120	50Hz/60Hz
Applied current	Arms	0.1~120	50Hz/60Hz
Output voltage	mV	1000±20	Io=50A RL=60Ω f=50Hz
Ratio of current trans.	-	3000 : 1	-
Output protection	Vp	7.5	-
Ratio error	%	±1.0	
Phase angle	°	≤1	
Insulation resistance	MΩ	≥100	DC500V
Operating temperature	°C	-20~+60	80%RH or less No condensation
Storage temperature	°C	-20~+75	80%RH or less No condensation



- All specifications in this catalog and production status of products are subject to change without notice. Prior to the purchase, please contact TOKIN for updated product data.
- Please request for a specification sheet for detailed product data prior to the purchase.
- Before using the product in this catalog, please read "Precautions" and other safety precautions listed in the printed version catalog.

# Thermal Sensor (TRS<sup>®</sup> Series & OHD<sup>™</sup> Series)

Temperature sensing switches composed of a magnet, reed switch and original temperature-sensing soft ferromagnetic substance called Thermorite<sup>™</sup>. It has simple circuit design, high reliability and excellent temperature accuracy.

## Features

- High reliability (Long product lifetime)
- Excellent temperature accuracy ( $\pm 2.5^{\circ}\text{C}$ ,  $\pm 5.0^{\circ}\text{C}$ )
- Wide range of operating temperature available
- Excellent environmental resistance
- Approved several safety standard

## Applications

- Thermal reed switch (TRS<sup>®</sup>)
  - Temperature detection of electric appliances
  - Overheat monitoring, temperature control of heater unit
- Thermal guard (OHD<sup>™</sup>)
  - OA equipment and other electric appliances
  - Atmospheric temperature detection of room heater, hot water heater and other general equipment

## Appearance

TRS<sup>®</sup> Series



OHD<sup>™</sup> Series

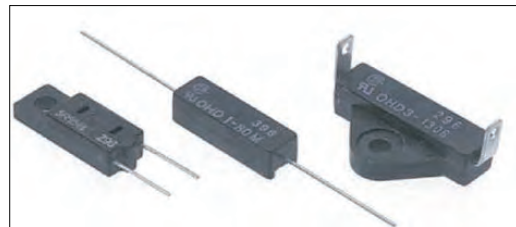

## Sensing temperature range

	-50°C	0°C	50°C	100°C	150°C	200°C	
TRS <sup>®</sup> Series		-10°C	Sensing accuracy $\pm 2.5^{\circ}\text{C} / \pm 5.0^{\circ}\text{C}$		130°C		※ Sensing temperature range is different in product series
OHD <sup>™</sup> Series			30°C	Sensing accuracy $\pm 5.0^{\circ}\text{C}$		130°C	※ Break type ※ Make type (OHD5R has only break type)



● All specifications in this catalog and production status of products are subject to change without notice. Prior to the purchase, please contact TOKIN for updated product data.  
 ● Please request for a specification sheet for detailed product data prior to the purchase.  
 ● Before using the product in this catalog, please read "Precautions" and other safety precautions listed in the printed version catalog.

# Pyroelectric Infrared Sensor (PL Series)

## Unobtrusive sensors that contribute to set designs

Pyroelectric Infrared Sensor using Pyroelectric effect of ceramic can detect even slight infrared energy from human body. By leveraging our proprietary technologies, we also propose new solutions such as detection through resin or glass and lens-less solutions, in addition to supporting lensed solutions.

### Features(Bulk sensor)

- Lens-less also possible
- Capable of detecting through resin or glass (no hole required)
- SMD type (Reflow soldering)
- Wide field of view ( $\pm 60$ deg)
- Low current consumption driving (a few  $\mu$ A)
- Excellent high frequency electric wave resistance
- Compact & Low profile (5.0x4.8x1.7mm)

### Applications

- Human sensor
- Housing equipment (Lighting, Toilet)
- Home appliance
- Kitchen appliance
- Contactless switch

Greater convenience  
 Saving energy  
 Improved design

### Lineup

	Detection distance(general guide)		
	Glass/Permeable resin ~20cm	~2m	~5m
Bulk	Sensor : PL-N823-01 Lens : Not needed		<b>Under development</b> Sensor : PL-Q873-01 Lens : PL-001L-W/BK
Standard module	—	<b>Under development</b> SS-430	<b>Under development</b> SS-430L-W/BK
High-sensitivity module	<b>Under development</b> SS-431	—	—
Notes	<b>[Cover material choices]</b> • Glass t3.2mm • ABS t2.0mm etc.	<b>[Limited cover material]</b> • High-density polyethylene (HDPE)	<b>[Cover material not needed]</b> • Lens eliminates need for cover • HDPE, if cover is to be used for design purposes

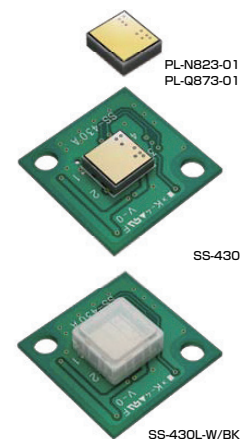

- All specifications in this catalog and production status of products are subject to change without notice. Prior to the purchase, please contact TOKIN for updated product data.
- Please request for a specification sheet for detailed product data prior to the purchase.
- Before using the product in this catalog, please read "Precautions" and other safety precautions listed in the printed version catalog.

# Vibration Sensor



Measure minute vibration in wide bandwidth and monitoring inside condition of equipment.

## Feature

- High sensitivity (20mV/m/s<sup>2</sup>)
- Wide bandwidth sensing (10Hz~15kHz) with reasonable price
- Original product design brings high conversion efficiency

## Application example <Pump vibration>



Measure two different operating sound of pumps

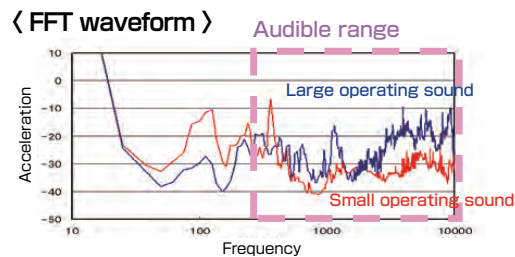
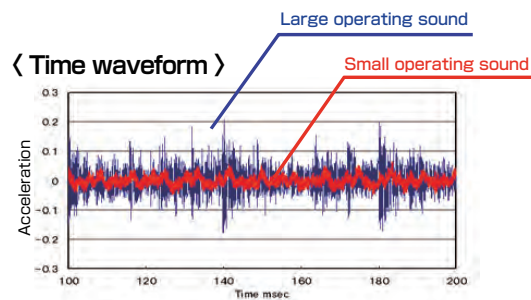

(VS-BVSeries)

## Specifications

Dimension without cable	[mm]	11.5x8.5x2.9 (typ.)
Weight without cable	[g]	0.9(typ.)
Drive voltage	[Vcc]	3.3V/0.3mA
Sensitivity	[mV/(m/s <sup>2</sup> )]	20 (typ.)
Offset voltage	[V]	1/2xVcc
Frequency range	[Hz]	10~15000[3dB]
Min. detect acceleration	[m/s <sup>2</sup> ]	0.003
Max. detect acceleration	[m/s <sup>2</sup> ]	50

※ Acceleration 1m/s<sup>2</sup> = 0.1G = 100Gal



- All specifications in this catalog and production status of products are subject to change without notice. Prior to the purchase, please contact TOKIN for updated product data.
- Please request for a specification sheet for detailed product data prior to the purchase.
- Before using the product in this catalog, please read "Precautions" and other safety precautions listed in the printed version catalog.

# Piezo Receiver / Speaker

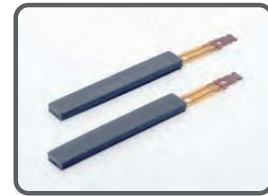

<New Type>Generates both Sound and Vibration from chassis at the same time

## Features

- Sound comes from panel surface
- Easy to hear in noisy surrounding
- No sound hole
- Easy for waterproof and dust -proofing design
- Design flexibility

## Application example

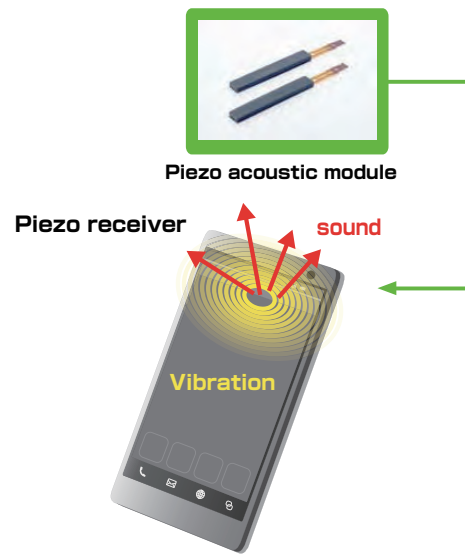

## Operation principle

Piezo bimorph

Piezo acoustic module

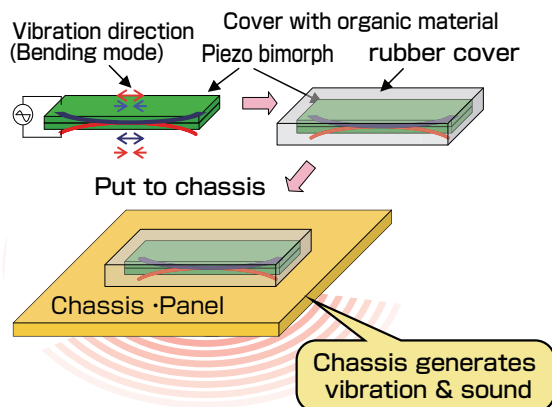

Conventional (Electromagnetic) Receiver

- Narrow hearing area
- Sound hole is necessary



## Specifications

	Item	Specification	Note
1	Input Voltage	20Vp-p	_____
2	Capacitance	960nF	at 1kHz-1Vrms
3	Dimension	26Lx4Wx1.7T	(mm)
4	Weight	0.8g	Including standard FPC
5	Sound Pressure	106±3dB(1kHz)	Original measuring condition

Dimension

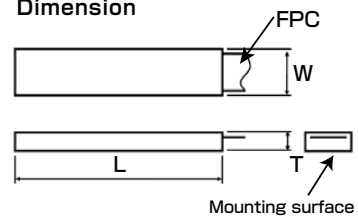

- All specifications in this catalog and production status of products are subject to change without notice. Prior to the purchase, please contact TOKIN for updated product data.
- Please request for a specification sheet for detailed product data prior to the purchase.
- Before using the product in this catalog, please read "Precautions" and other safety precautions listed in the printed version catalog.



# Multilayer Piezoelectric Actuators

Contributing to the realization of devices with higher speed, higher accuracy, higher power generation, reduced size, and lower power consumption.

## Applications

- Valve control (MFC/proportional control valve)
- Probe control
- High speed focusing, 3D image acquisition
- Optical fiber/laser optical axis adjustment
- Interferometer mirror adjustment
- Correction of mirror angle displacement
- Pixel shifting for the image sensor
- Precise stage positioning
- Nanoimprint positioning
- Clamping (wire bonder)
- Dispensing equipment (ink jet/dispenser)
- Excitation/damping equipment
- Various tests (pressure, fatigue, wear, etc.)
- Various machining (precise centering, precise feeding)

Bring Fine, Quick and Power by Piezo technology

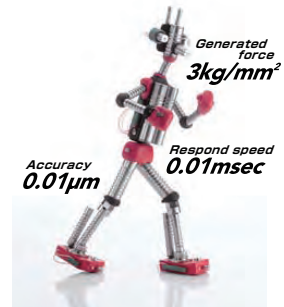

## Resin coated type

We are enhancing our lineup from large displacement products to large power generating products.

	Displacement (µm) at 150Vdc	Generated force (N)	Operating temperature
AE Series	4.6~42.0	200~20,000	-25°C~+85°C

- Ring shape, ultra compact actuator and other custom design are available. Please contact us for further details.

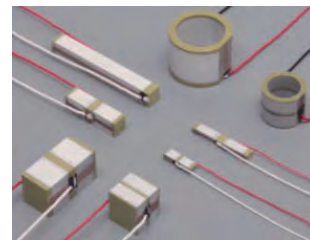

## Metal case type

High reliability by metal encapsulate

	Displacement (µm) at 150Vdc	Generated force (N)	Operating temperature
ASB Series	17~84	200~3,000	-25°C~+85°C
ASL Series	19~77	800	-40°C~+150°C
AHB Series	55~240	800~3,600	-25°C~+85°C

- Two flange types available for installation
- \* For detail specification, please refer to the catalogue of multilayer piezoelectric actuator



- All specifications in this catalog and production status of products are subject to change without notice. Prior to the purchase, please contact TOKIN for updated product data.
- Please request for a specification sheet for detailed product data prior to the purchase.
- Before using the product in this catalog, please read "Precautions" and other safety precautions listed in the printed version catalog.

# Piezoelectric Ceramics

Contributing to the electronics industry through in-house developed high performance piezoelectric ceramics and application technologies.

## Standard Ceramic Material

(Main material characteristics)

Characteristics	N6	N61	N85	N10	N17	N21
Dielectric constant	L	L	M	H	H	M
Electromechanical coupling factor	M	M	H	H	H	H
Piezoelectric d constant	L	L	L	H	H	M
Piezoelectric g constant	M	M	M	L	L	H
Mechanical Quality Factor	M	M	H	L	L	L
Curie Temperature	H	H	M	L	M	H



- Characteristic Value: H = High, M = Medium, L = Low
- Other materials are available. Please contact us for details.

## Applications

Piezoelectric Ceramic Function	Application Field
Acoustic & Ultrasonic	Sonar, Fish Finder, Medical Application, Flow Meter, Actuator for Camera, Measurement equipment
Piezoelectric Effect	Shock, Vibration, Pressure, Motion and Acceleration Sensors, Energy Harvest
Pyroelectric Effect	Motion Sensor (Human Detection)
Inverse Piezoelectric Effect	Pump, Valve, Haptic device, Knitting machine, Positioner, DSC Dust reduction

## Product Lineup

- Custom Piezoelectric Elements
- Langevin Bolt-on Transducers
- Ultrasonic Cleaning Elements
- Piezoelectric Bimorphs
- Molded Waterproof Transducers
- High Frequency Transducers
- Aerial Microphone Transducers
- Sonar Transducers



- All specifications in this catalog and production status of products are subject to change without notice. Prior to the purchase, please contact TOKIN for updated product data.
- Please request for a specification sheet for detailed product data prior to the purchase.
- Before using the product in this catalog, please read "Precautions" and other safety precautions listed in the printed version catalog.



## Precautions



- The names of the products and the specifications in this catalog are subject to change without notice for the sake of improvement. The manufacturer also reserves the right to discontinue any of these products. At the time of delivery, please ask for specification sheets to check the contents before use.
- Descriptions in this catalog regarding product characteristics and quality are based solely on discrete components. When using these components, be sure to check the specifications with the component in question mounted on the products.
- The manufacturer's warranty will not cover any disadvantage or damage caused by improper use of the products, deviating from the characteristics, specifications, or conditions for use described in this catalog.
- Please be advised that the manufacturer accepts no responsibility for any infringement on third party patents or industrial copyrights by users of the manufacturer's products. The manufacturer is responsible only when such infringements are attributable to the structural design of the product and its manufacturing process.
- No part of this document may be reproduced without written permission from the manufacturer.
- Export Control
  - For customers outside Japan  
TOKIN products should not be used or sold for use in the development, production, stockpiling or utilization of any conventional weapons or mass-destructive weapons (nuclear weapons, chemical or biological weapons, or missiles), or any other weapons.
  - For customers in Japan  
For products which are controlled items subject to the "Foreign Exchange and Foreign Trade Law" of Japan, the export license specified by the law is required for export.
- This catalog is current as of November 2017.



- All specifications in this catalog and production status of products are subject to change without notice. Prior to the purchase, please contact TOKIN for updated product data.
- Please request for a specification sheet for detailed product data prior to the purchase.
- Before using the product in this catalog, please read "Precautions" and other safety precautions listed in the printed version catalog.

# Mouser Electronics

Authorized Distributor

Click to View Pricing, Inventory, Delivery & Lifecycle Information:

## KEMET:

[SSHB21HS-03656](#) [SSHB21HS-04507](#) [SSHB21HS-05440](#) [SSHB21HS-06378](#) [SSHB21HS-07267](#) [SSHB21HS-08200](#) [SSRH7H-M20016](#) [SSRH7HS-M03925](#) [SSRH7HS-M04467](#) [SSRH7HS-M05324](#) [SSRH7HS-M06185](#) [SSRH7HS-M07154](#) [SSRH7H-M08169](#) [SSRH7H-M10108](#) [SSRH7H-M11081](#) [SSRH7H-M13064](#) [SSRH7H-M15043](#) [SSRH7H-M17029](#) [SSRH7HS-M20013](#) [SSRH7H-M031157](#) [SSRH7H-M04596](#) [SSRH7H-M05408](#) [SSRH7H-M06237](#) [SSRH7H-M07196](#) [SSRH7HS-M08134](#) [SSRH7HS-M10084](#) [SSRH7HS-M11064](#) [SSRH7HS-M13046](#) [SSRH7HS-M15036](#) [SSRH7HS-M17023](#) [SSHB10HS-10051](#) [SSHB10HS-11043](#) [SSHB10HS-13030](#) [SSHB10HS-17019](#) [SSHB10HS-22011](#) [SSHB10HS-30006](#) [SSHB21HS-30013](#) [SSHB10HS-04265](#) [SSHB10HS-05177](#) [SSHB10HS-06140](#) [SSHB10HS-07099](#) [SSHB10HS-08068](#) [SSHB21HS-10145](#) [SSHB21HS-12110](#) [SSHB21HS-15064](#) [SSHB21HS-18046](#) [SSHB21HS-20034](#) [SSHB21HS-25021](#) [SSRH24NV-12655](#) [SSRH24NV-16470](#) [SSRH24NV-20310](#) [SSRH24NV-25205](#) [SSRH24NV-30145](#) [SSRH24NV-35086](#) [SSRH24NHS-25130](#) [SSRH24NHS-30092](#) [SSRH24NHS-35080](#) [SSRH24NHS-40059](#) [SSRH24NHS-45041](#) [SSRH24NHS-50026](#) [SSRH24NVS-50026](#) [SSRH24NH-45059](#) [SSRH24NH-50041](#) [SSRH24NHS-12500](#) [SSRH24NHS-16320](#) [SSRH24NHS-20215](#) [SSRH24NH-40069](#) [SSRH24NVS-25130](#) [SSRH24NVS-30092](#) [SSRH24NVS-35080](#) [SSRH24NVS-40059](#) [SSRH24NVS-45041](#) [SSRH24NH-12655](#) [SSRH24NH-16470](#) [SSRH24NH-20310](#) [SSRH24NH-25205](#) [SSRH24NH-30145](#) [SSRH24NH-35086](#) [SSRH24NV-40069](#) [SSRH24NV-45059](#) [SSRH24NV-50041](#) [SSRH24NVS-12500](#) [SSRH24NVS-16320](#) [SSRH24NVS-20215](#)

## Данный компонент на территории Российской Федерации

### Вы можете приобрести в компании MosChip.

Для оперативного оформления запроса Вам необходимо перейти по данной ссылке:

<http://moschip.ru/get-element>

Вы можете разместить у нас заказ для любого Вашего проекта, будь то серийное производство или разработка единичного прибора.

В нашем ассортименте представлены ведущие мировые производители активных и пассивных электронных компонентов.

Нашей специализацией является поставка электронной компонентной базы двойного назначения, продукции таких производителей как XILINX, Intel (ex.ALTERA), Vicor, Microchip, Texas Instruments, Analog Devices, Mini-Circuits, Amphenol, Glenair.

Сотрудничество с глобальными дистрибьюторами электронных компонентов, предоставляет возможность заказывать и получать с международных складов практически любой перечень компонентов в оптимальные для Вас сроки.

На всех этапах разработки и производства наши партнеры могут получить квалифицированную поддержку опытных инженеров.

Система менеджмента качества компании отвечает требованиям в соответствии с ГОСТ Р ИСО 9001, ГОСТ РВ 0015-002 и ЭС РД 009

### Офис по работе с юридическими лицами:

105318, г.Москва, ул.Щербаковская д.3, офис 1107, 1118, ДЦ «Щербаковский»

Телефон: +7 495 668-12-70 (многоканальный)

Факс: +7 495 668-12-70 (доб.304)

E-mail: [info@moschip.ru](mailto:info@moschip.ru)

Skype отдела продаж:

moschip.ru

moschip.ru\_4

moschip.ru\_6

moschip.ru\_9