



STGW30NC120HD

N-channel 1200V - 30A - TO-247
very fast PowerMESH™ IGBT

Features

Type	V _{CES}	V _{CE(sat)} @25°C	I _C @100°C
STGW30NC120HD	1200V	< 2.75V	30A

- Low on-losses
- Low on-voltage drop (V_{cesat})
- High current capability
- High input impedance (voltage driven)
- Low gate charge
- Ideal for soft switching application

Application

- Induction heating

Description

Using the latest high voltage technology based on its patented strip layout, STMicroelectronics has designed an advanced family of IGBTs, with outstanding performances. The suffix “H” identifies a family optimized for high frequency application in order to achieve very high switching performances (reduced t_{fall}) maintaining a low voltage drop.

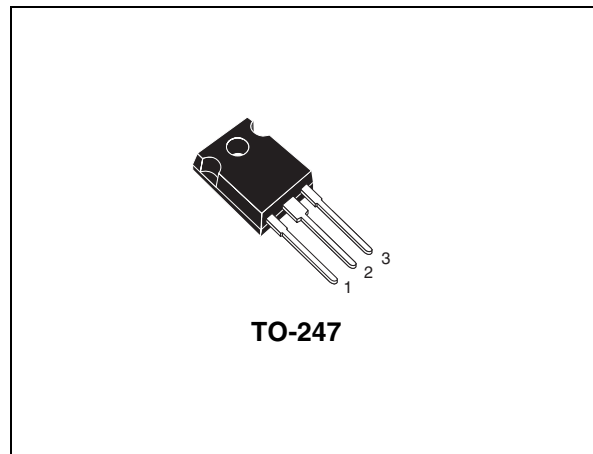

Figure 1. Internal schematic diagram

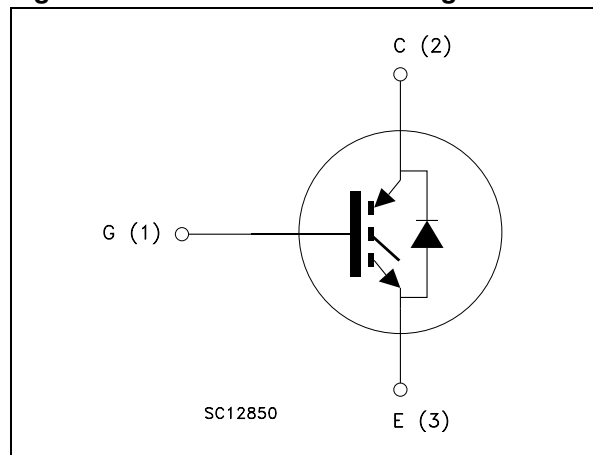

Table 1. Device summary

Order code	Marking	Package	Packaging
STGW30NC120HD	GW30NC120HD	TO-247	Tube

Contents

1	Electrical ratings	3
2	Electrical characteristics	4
	2.1 Electrical characteristics (curves)	6
3	Test circuit	9
4	Package mechanical data	10
5	Revision history	12

1 Electrical ratings

Table 2. Absolute maximum ratings

Symbol	Parameter	Value	Unit
V_{CES}	Collector-emitter voltage ($V_{GS} = 0$)	1200	V
$I_C^{(1)}$	Collector current (continuous) at 25°C	60	A
$I_C^{(1)}$	Collector current (continuous) at 100°C	30	A
$I_{CL}^{(2)}$	Collector current (pulsed)	135	A
V_{GE}	Gate-emitter voltage	±25	V
P_{TOT}	Total dissipation at $T_C = 25^\circ\text{C}$	220	W
I_f	Diode RMS forward current at $T_C = 25^\circ\text{C}$	30	A
T_j	Operating junction temperature	-55 to 150	°C

1. Calculated according to the iterative formula:

$$I_C(T_C) = \frac{T_{JMAX} - T_C}{R_{THJ-C} \times V_{CESAT(MAX)}(T_C, I_C)}$$

2. $V_{clamp}=80\%$ of BV_{ces} , $T_j=150^\circ\text{C}$, $R_G=10\Omega$, $V_{GE}=15\text{V}$

Table 3. Thermal resistance

Symbol	Parameter	Value	Unit
$R_{thj-case}$	Thermal resistance junction-case	0.57	°C/W
$R_{thj-amb}$	Thermal resistance junction-ambient (diode)	1.6	°C/W
$R_{thj-amb}$	Thermal resistance junction-ambient (IGBT)	30	°C/W

2 Electrical characteristics

($T_{CASE}=25^{\circ}C$ unless otherwise specified)

Table 4. Static

Symbol	Parameter	Test conditions	Min.	Typ.	Max.	Unit
$V_{BR(CES)}$	Collector-emitter breakdown voltage	$I_C = 1mA, V_{GE} = 0$	1200			V
$V_{CE(SAT)}$	Collector-emitter saturation voltage	$V_{GE}= 15V, I_C= 20A, T_j= 25^{\circ}C$ $V_{GE}= 15V, I_C= 20A, T_j=125^{\circ}C$		2.2 2.0	2.75	V V
$V_{GE(th)}$	Gate threshold voltage	$V_{CE}= V_{GE}, I_C= 250\mu A$	3.75		5.75	V
I_{CES}	Collector-emitter leakage current ($V_{GE} = 0$)	$V_{CE} = \text{Max rating}, T_c=25^{\circ}C$ $V_{CE} = \text{Max rating}, T_c=125^{\circ}C$			500 10	μA mA
I_{GES}	Gate-emitter leakage current ($V_{CE} = 0$)	$V_{GE} = \pm 20V, V_{CE} = 0$			± 100	nA
g_{fs}	Forward transconductance	$V_{CE} = 25V, I_C= 20A$		14		S

Table 5. Dynamic

Symbol	Parameter	Test conditions	Min.	Typ.	Max.	Unit
C_{ies}	Input capacitance	$V_{CE} = 25V, f = 1 \text{ MHz}, V_{GE}=0$		2510		pF
C_{oes}	Output capacitance			175		pF
C_{res}	Reverse transfer capacitance			30		pF
Q_g	Total gate charge	$V_{CE} = 960V,$ $I_C= 20A, V_{GE}=15V$		110		nC
Q_{ge}	Gate-emitter charge			16		nC
Q_{gc}	Gate-collector charge			49		nC

Table 6. Switching on/off (inductive load)

Symbol	Parameter	Test conditions	Min.	Typ.	Max.	Unit
$t_{d(on)}$	Turn-on delay time	$V_{CC} = 960V, I_C = 20A$		29		ns
t_r	Current rise time	$R_G = 10\Omega, V_{GE} = 15V,$		11		ns
$(di/dt)_{on}$	Turn-on current slope	$T_j = 25^\circ C$ (see Figure 17)		1820		A/ μs
$t_{d(on)}$	Turn-on delay time	$V_{CC} = 960V, I_C = 20A$		27		ns
t_r	Current rise time	$R_G = 10\Omega, V_{GE} = 15V,$		14		ns
$(di/dt)_{on}$	Turn-on current slope	$T_j = 125^\circ C$ (see Figure 17)		1580		A/ μs
$t_r(V_{off})$	Off voltage rise time	$V_{CC} = 960V, I_C = 20A$		90		ns
$t_{d(off)}$	Turn-off delay time	$R_G = 10\Omega, V_{GE} = 15V,$		275		ns
t_f	Current fall time	$T_j = 25^\circ C$ (see Figure 17)		312		ns
$t_r(V_{off})$	Off voltage rise time	$V_{CC} = 960V, I_C = 20A$		150		ns
$t_{d(off)}$	Turn-off delay time	$R_G = 10\Omega, V_{GE} = 15V,$		336		ns
t_f	Current fall time	$T_j = 125^\circ C$ (see Figure 17)		592		ns

Table 7. Switching energy (inductive load)

Symbol	Parameter	Test conditions	Min.	Typ.	Max.	Unit
$E_{on}^{(1)}$	Turn-on switching losses	$V_{CC} = 960V, I_C = 20A$		1660		μJ
$E_{off}^{(2)}$	Turn-off switching losses	$R_G = 10\Omega, V_{GE} = 15V,$		4438		μJ
E_{ts}	Total switching losses	$T_j = 25^\circ C$ (see Figure 17)		6098		μJ
$E_{on}^{(1)}$	Turn-on switching losses	$V_{CC} = 960V, I_C = 20A$		3015		μJ
$E_{off}^{(2)}$	Turn-off switching losses	$R_G = 10\Omega, V_{GE} = 15V,$		6900		μJ
E_{ts}	Total switching losses	$T_j = 125^\circ C$ (see Figure 17)		9915		μJ

1. E_{on} is the turn-on losses when a typical diode is used in the test circuit in figure 2. If the IGBT is offered in a package with a co-pack diode, the co-pack diode is used as external diode. IGBTs & Diode are at the same temperature (25°C and 125°C)

2. Turn-off losses include also the tail of the collector current

Table 8. Collector-emitter diode

Symbol	Parameter	Test conditions	Min.	Typ.	Max.	Unit
V_f	Forward on-voltage	$I_f = 20A, T_j = 25^\circ C$ $I_f = 20A, T_j = 125^\circ C$		1.9 1.7	2.5	V V
t_{rr}	Reverse recovery time	$I_f = 20A, V_R = 27V,$		152		ns
Q_{rr}	Reverse recovery charge	$T_j = 125^\circ C, di/dt = 100A/\mu s$		722		nC
I_{rrm}	Reverse recovery current	(see Figure 20)		9		A

2.1 Electrical characteristics (curves)

Figure 2. Output characteristics

Figure 3. Transfer characteristics

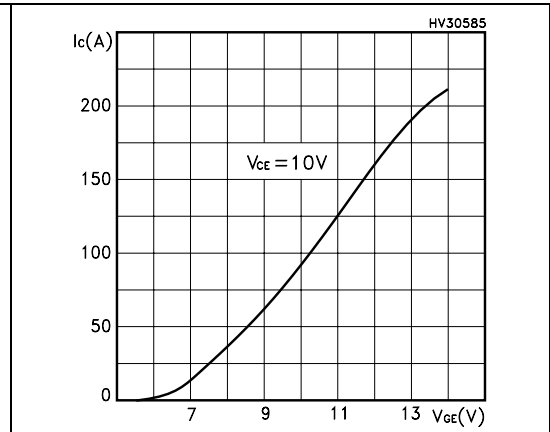
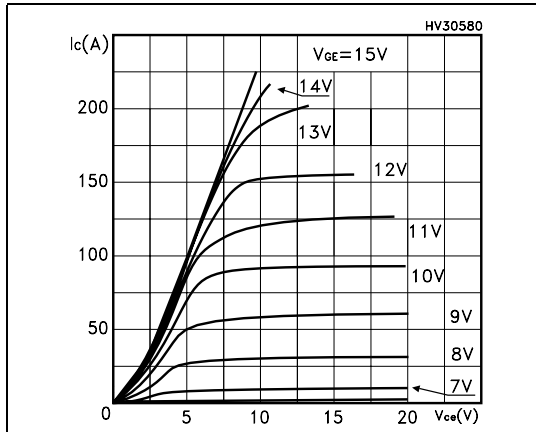

Figure 4. Transconductance

Figure 5. Collector-emitter on voltage vs. temperature

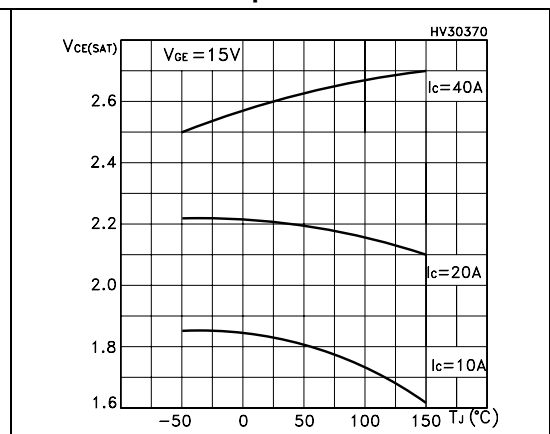
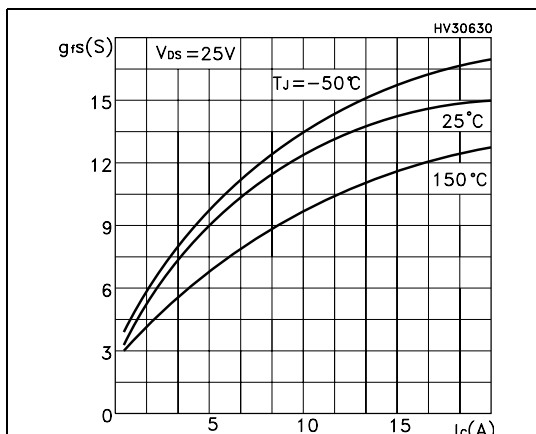

Figure 6. Gate charge vs. gate-source voltage

Figure 7. Capacitance variations

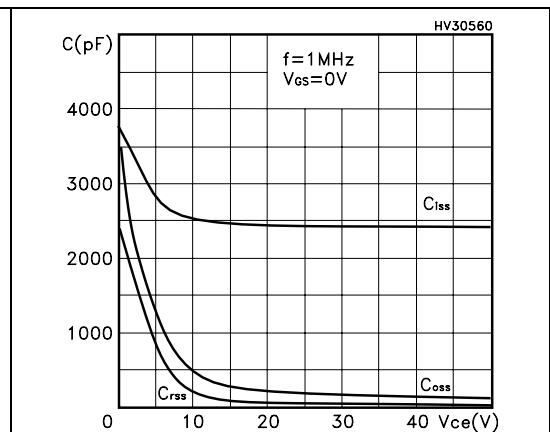
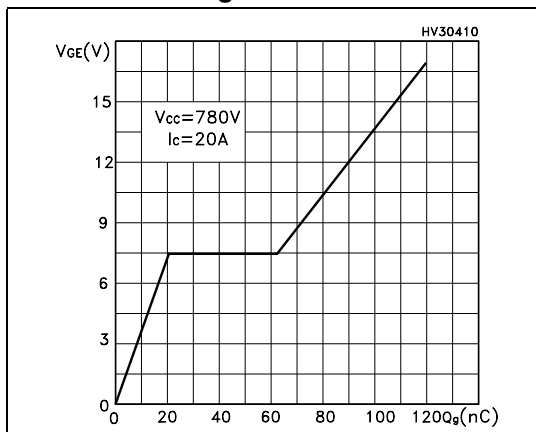

Figure 8. Normalized gate threshold voltage vs. temperature

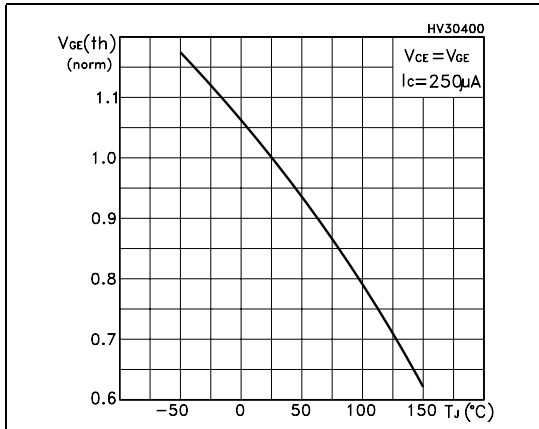

Figure 9. Collector-emitter on voltage vs. collector current

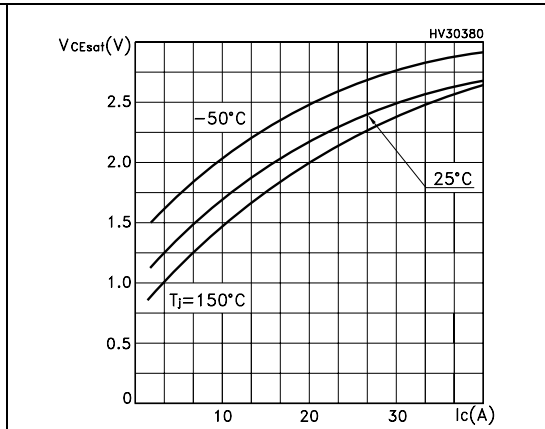

Figure 10. Normalized breakdown voltage vs. temperature

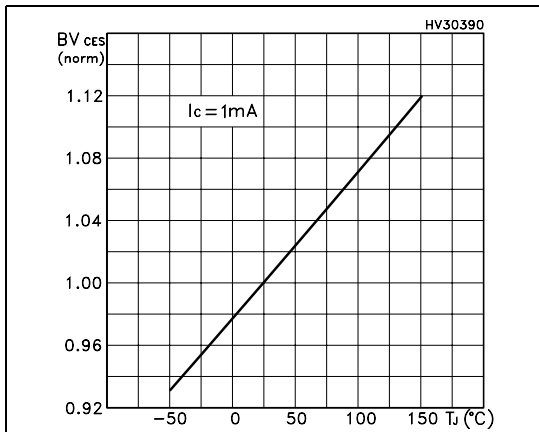

Figure 11. Switching losses vs. temperature

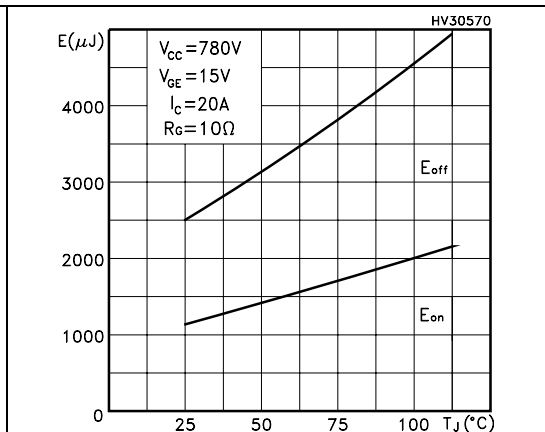

Figure 12. Switching losses vs. gate resistance

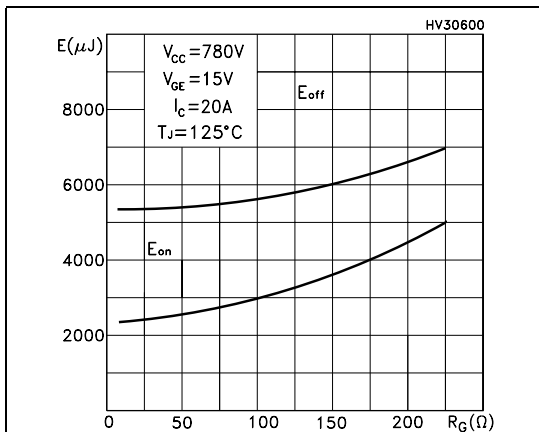

Figure 13. Switching losses vs. collector current

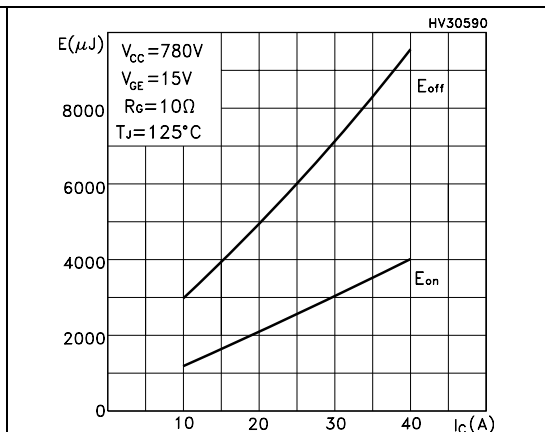

Figure 14. Thermal Impedance

Figure 15. Turn-off SOA

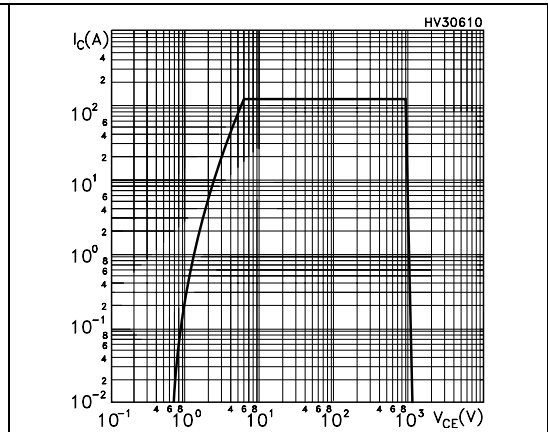
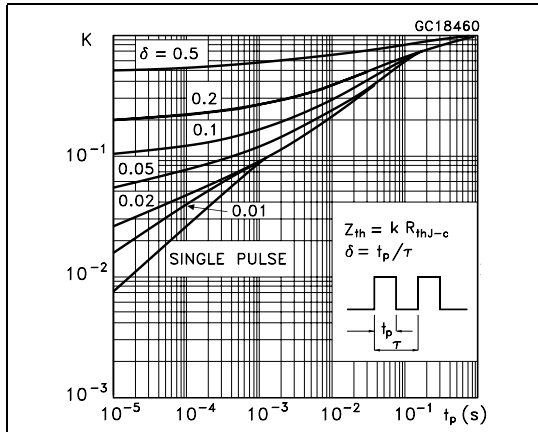
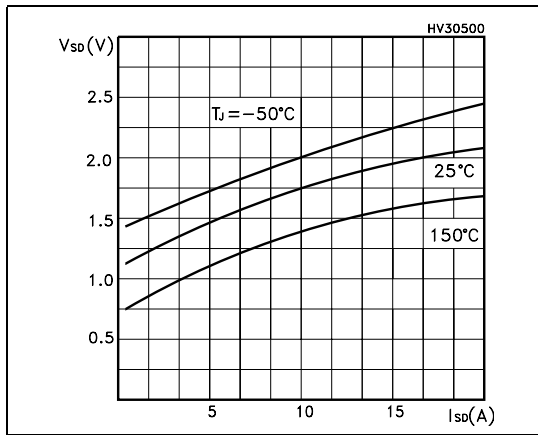

Figure 16. Emitter-collector diode characteristics



3 Test circuit

Figure 17. Test circuit for inductive load switching

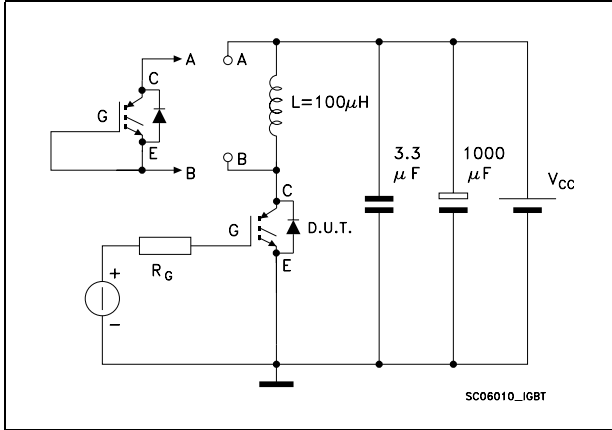

Figure 19. Switching waveform

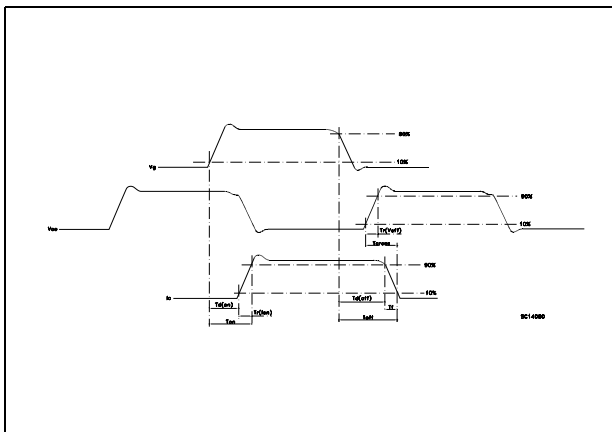

Figure 18. Gate charge test circuit

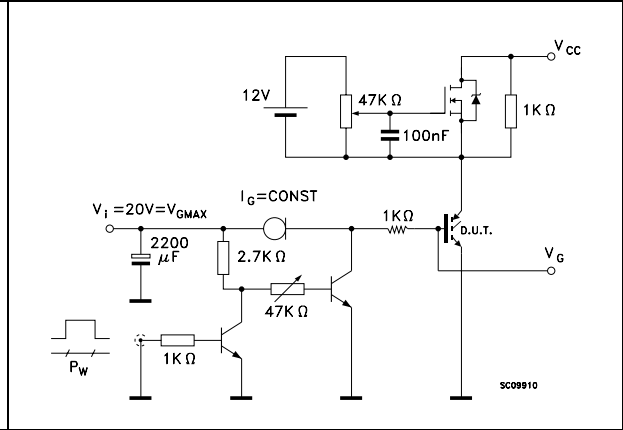
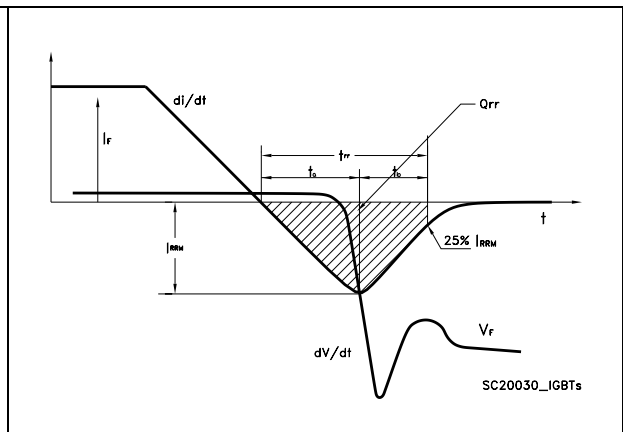

Figure 20. Diode recovery time waveform



4 Package mechanical data

In order to meet environmental requirements, ST offers these devices in ECOPACK® packages. These packages have a Lead-free second level interconnect. The category of second level interconnect is marked on the package and on the inner box label, in compliance with JEDEC Standard JESD97. The maximum ratings related to soldering conditions are also marked on the inner box label. ECOPACK is an ST trademark. ECOPACK specifications are available at: www.st.com

TO-247 MECHANICAL DATA

DIM.	mm.			inch		
	MIN.	TYP	MAX.	MIN.	TYP.	MAX.
A	4.85		5.15	0.19		0.20
A1	2.20		2.60	0.086		0.102
b	1.0		1.40	0.039		0.055
b1	2.0		2.40	0.079		0.094
b2	3.0		3.40	0.118		0.134
c	0.40		0.80	0.015		0.03
D	19.85		20.15	0.781		0.793
E	15.45		15.75	0.608		0.620
e		5.45			0.214	
L	14.20		14.80	0.560		0.582
L1	3.70		4.30	0.14		0.17
L2		18.50			0.728	
øP	3.55		3.65	0.140		0.143
øR	4.50		5.50	0.177		0.216
S		5.50			0.216	

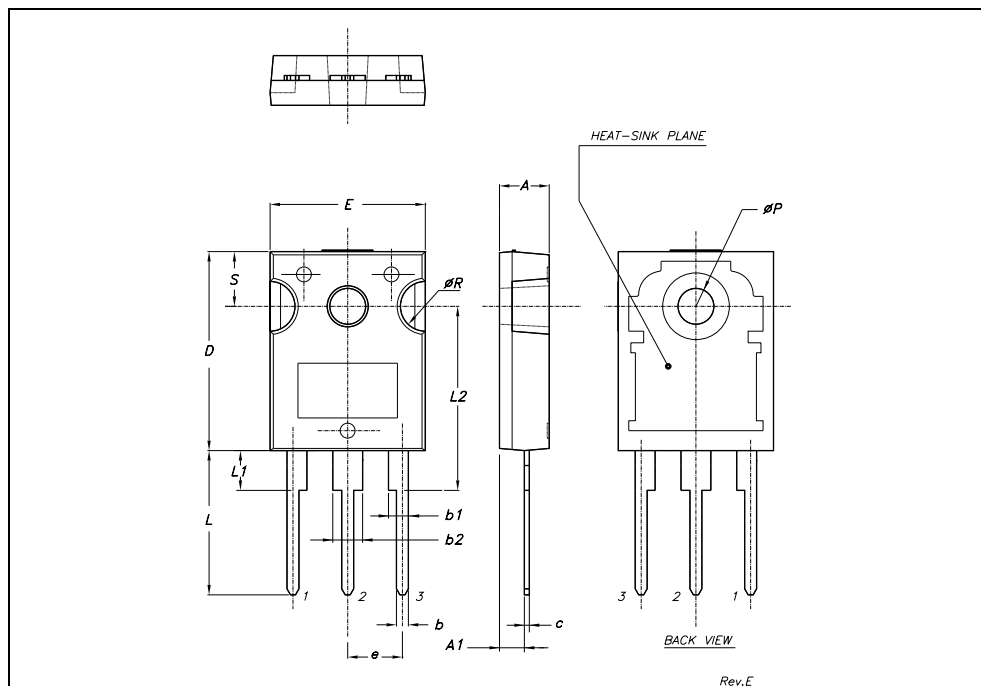

5 Revision history

Table 9. Document revision history

Date	Revision	Changes
23-Nov-2005	1	First issue.
17-Mar-2006	2	Complete version
05-May-2006	3	Modified value on Table 2.: Absolute maximum ratings
30-May-2006	4	New values on Table 3: Thermal resistance
23-Jun-2006	5	Modified value on Table 4.: Static
07-Sep-2006	6	Modified T _J temperature range to 150°C in Table 2.: Absolute maximum ratings
14-Nov-2006	7	Modified Figure 5. and Figure 9.
26-Jan-2007	8	Typing error on first page.
04-Oct-2007	9	Modified test conditions in Table 4.: Static

Please Read Carefully:

Information in this document is provided solely in connection with ST products. STMicroelectronics NV and its subsidiaries ("ST") reserve the right to make changes, corrections, modifications or improvements, to this document, and the products and services described herein at any time, without notice.

All ST products are sold pursuant to ST's terms and conditions of sale.

Purchasers are solely responsible for the choice, selection and use of the ST products and services described herein, and ST assumes no liability whatsoever relating to the choice, selection or use of the ST products and services described herein.

No license, express or implied, by estoppel or otherwise, to any intellectual property rights is granted under this document. If any part of this document refers to any third party products or services it shall not be deemed a license grant by ST for the use of such third party products or services, or any intellectual property contained therein or considered as a warranty covering the use in any manner whatsoever of such third party products or services or any intellectual property contained therein.

UNLESS OTHERWISE SET FORTH IN ST'S TERMS AND CONDITIONS OF SALE ST DISCLAIMS ANY EXPRESS OR IMPLIED WARRANTY WITH RESPECT TO THE USE AND/OR SALE OF ST PRODUCTS INCLUDING WITHOUT LIMITATION IMPLIED WARRANTIES OF MERCHANTABILITY, FITNESS FOR A PARTICULAR PURPOSE (AND THEIR EQUIVALENTS UNDER THE LAWS OF ANY JURISDICTION), OR INFRINGEMENT OF ANY PATENT, COPYRIGHT OR OTHER INTELLECTUAL PROPERTY RIGHT.

UNLESS EXPRESSLY APPROVED IN WRITING BY AN AUTHORIZED ST REPRESENTATIVE, ST PRODUCTS ARE NOT RECOMMENDED, AUTHORIZED OR WARRANTED FOR USE IN MILITARY, AIR CRAFT, SPACE, LIFE SAVING, OR LIFE SUSTAINING APPLICATIONS, NOR IN PRODUCTS OR SYSTEMS WHERE FAILURE OR MALFUNCTION MAY RESULT IN PERSONAL INJURY, DEATH, OR SEVERE PROPERTY OR ENVIRONMENTAL DAMAGE. ST PRODUCTS WHICH ARE NOT SPECIFIED AS "AUTOMOTIVE GRADE" MAY ONLY BE USED IN AUTOMOTIVE APPLICATIONS AT USER'S OWN RISK.

Resale of ST products with provisions different from the statements and/or technical features set forth in this document shall immediately void any warranty granted by ST for the ST product or service described herein and shall not create or extend in any manner whatsoever, any liability of ST.

ST and the ST logo are trademarks or registered trademarks of ST in various countries.

Information in this document supersedes and replaces all information previously supplied.

The ST logo is a registered trademark of STMicroelectronics. All other names are the property of their respective owners.

© 2007 STMicroelectronics - All rights reserved

STMicroelectronics group of companies

Australia - Belgium - Brazil - Canada - China - Czech Republic - Finland - France - Germany - Hong Kong - India - Israel - Italy - Japan - Malaysia - Malta - Morocco - Singapore - Spain - Sweden - Switzerland - United Kingdom - United States of America

www.st.com



Данный компонент на территории Российской Федерации

Вы можете приобрести в компании MosChip.

Для оперативного оформления запроса Вам необходимо перейти по данной ссылке:

<http://moschip.ru/get-element>

Вы можете разместить у нас заказ для любого Вашего проекта, будь то серийное производство или разработка единичного прибора.

В нашем ассортименте представлены ведущие мировые производители активных и пассивных электронных компонентов.

Нашей специализацией является поставка электронной компонентной базы двойного назначения, продукции таких производителей как XILINX, Intel (ex.ALTERA), Vicor, Microchip, Texas Instruments, Analog Devices, Mini-Circuits, Amphenol, Glenair.

Сотрудничество с глобальными дистрибьюторами электронных компонентов, предоставляет возможность заказывать и получать с международных складов практически любой перечень компонентов в оптимальные для Вас сроки.

На всех этапах разработки и производства наши партнеры могут получить квалифицированную поддержку опытных инженеров.

Система менеджмента качества компании отвечает требованиям в соответствии с ГОСТ Р ИСО 9001, ГОСТ РВ 0015-002 и ЭС РД 009

Офис по работе с юридическими лицами:

105318, г.Москва, ул.Щербаковская д.3, офис 1107, 1118, ДЦ «Щербаковский»

Телефон: +7 495 668-12-70 (многоканальный)

Факс: +7 495 668-12-70 (доб.304)

E-mail: info@moschip.ru

Skype отдела продаж:

moschip.ru

moschip.ru_4

moschip.ru_6

moschip.ru_9