

IS31AP4912

STEREO HEADPHONE DRIVER

December 2011

GENERAL DESCRIPTION

The IS31AP4912 is stereo headphone drivers designed to allow the removal of the output DC-blocking capacitors for reduced component count and cost. The IS31AP4912 is ideal for small portable electronics where size and cost are critical design parameters.

The IS31AP4912 integrates click-and-pop suppression circuitry and thermal protect circuit. The gain of the amplifier is adjusted via external resistors.

IS31AP4912 is available in UTQFN-12 (2mm × 2mm) packages. It operates from 2.7V to 5.5V over the temperature range of -40°C to +85°C.

FEATURES

- No output DC-blocking capacitors
- Supply voltage from 2.7V ~ 5.5V
- Low output noise (7μV)
- High SNR (103dB)
- -95dB PSRR
- Thermal protect circuit
- Integrated click-and-pop suppression circuitry
- UTQFN-12 (2mm × 2mm) package

APPLICATIONS

- Cellular handsets and PDAs
- Notebook PC
- MP3
- Portable gaming

TYPICAL APPLICATION CIRCUIT

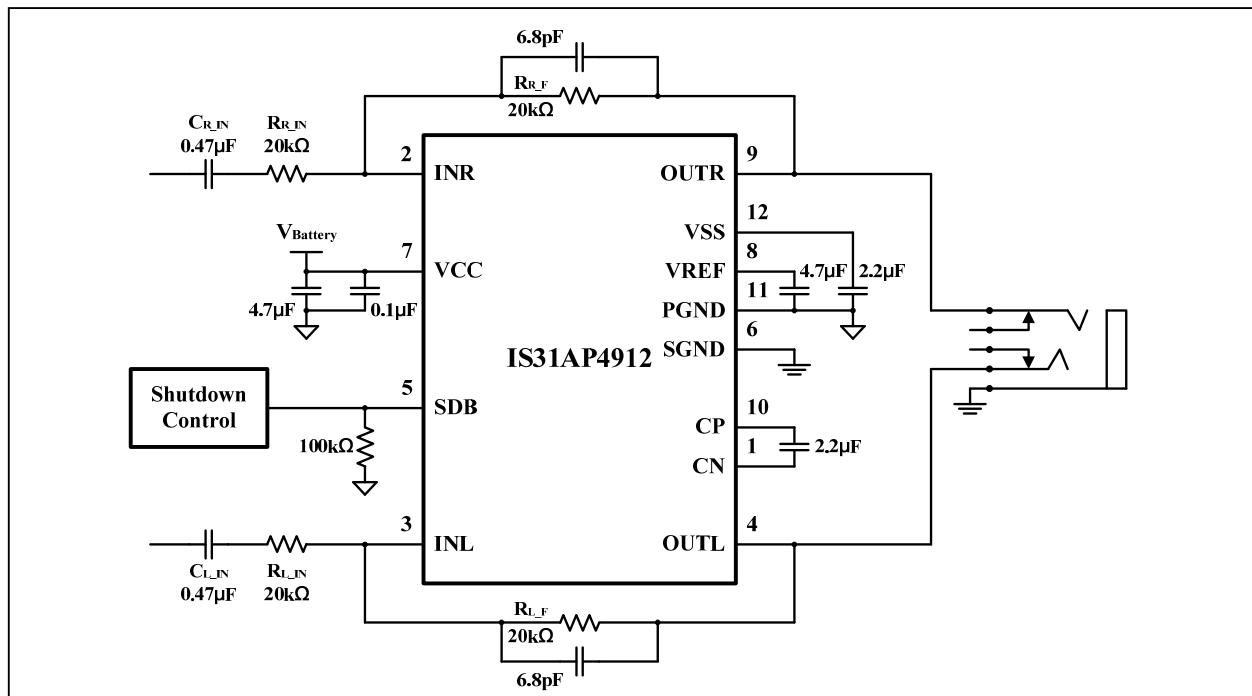
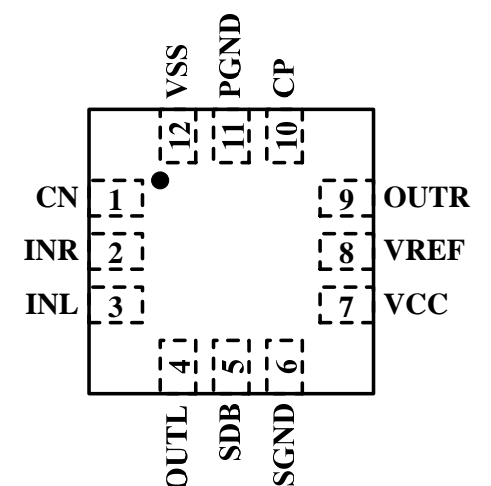

Figure 1 Typical Application Circuit

Note: The SGND and PGND pins of the IS31AP4912 must be routed separately back to the decoupling capacitor in order to provide proper device operation. If the SGND and PGND pins are connected directly to each other, the part functions without risk of failure, but the noise and THD performance do not meet the specifications.

IS31AP4912

PIN CONFIGURATION

Package	Pin Configuration (Top View)
UTQFN-12	

PIN DESCRIPTION

No.	Pin	Description
1	CN	Charge pump flying capacitor negative terminal.
2	INR	Right channel audio input.
3	INL	Left channel audio input.
4	OUTL	Left channel audio output.
5	SDB	Shutdown control terminal, active low.
6	SGND	Signal Ground.
7	VCC	Supply voltage.
8	VREF	Internal produced supply voltage for charge pump and audio power amplifier.
9	OUTR	Right channel audio output.
10	CP	Charge pump flying capacitor positive terminal.
11	PGND	Power ground.
12	VSS	Output from charge pump.

Copyright © 2011 Integrated Silicon Solution, Inc. All rights reserved. ISSI reserves the right to make changes to this specification and its products at any time without notice. ISSI assumes no liability arising out of the application or use of any information, products or services described herein. Customers are advised to obtain the latest version of this device specification before relying on any published information and before placing orders for products. Integrated Silicon Solution, Inc. does not recommend the use of any of its products in life support applications where the failure or malfunction of the product can reasonably be expected to cause failure of the life support system or to significantly affect its safety or effectiveness. Products are not authorized for use in such applications unless Integrated Silicon Solution, Inc. receives written assurance to its satisfaction, that:

- a.) the risk of injury or damage has been minimized;
- b.) the user assume all such risks; and
- c.) potential liability of Integrated Silicon Solution, Inc is adequately protected under the circumstances



IS31AP4912

ORDERING INFORMATION

Industrial Range: -40°C to +85°C

Order Part No.	Package	QTY/Reel
IS31AP4912-UTLS2-TR	UTQFN-12, Lead-free	3000



IS31AP4912

ABSOLUTE MAXIMUM RATINGS

Supply voltage, V_{DD}	-0.3V ~ +6.0V
Voltage at any input pin	-0.3V ~ $V_{DD}+0.3V$
Maximum junction temperature, T_{JMAX}	150°C
Storage temperature range, T_{STG}	-65°C ~ +150°C
Operating temperature range, T_A	-40°C ~ +85°C

Note:

Stresses beyond those listed under "Absolute Maximum Ratings" may cause permanent damage to the device. These are stress ratings only and functional operation of the device at these or any other condition beyond those indicated in the operational sections of the specifications is not implied. Exposure to absolute maximum rating conditions for extended periods may affect device reliability.

ELECTRICAL CHARACTERISTICS

$V_{CC} = 2.7V \sim 5.5V$, $T_A = 25^\circ C$, unless otherwise noted. Typical value is $T_A = 25^\circ C$, $V_{CC} = 3.6V$.

Symbol	Parameter	Condition	Min.	Typ.	Max.	Unit
V_{CC}	Supply voltage		2.7		5.5	V
I_{CC}	Quiescent current	No load		3	5	mA
I_{SD}	Shutdown current	$V_{SDB} = 0V$			1	μA
F_{OSC}	Operating frequency			250		kHz
$ V_{OS} $	Output offset voltage	$V_{(IN)} = 0V$		1		mV
V_{IH}	High-level input voltage		1.4			V
V_{IL}	Low-level input voltage				0.4	V

ELECTRICAL CHARACTERISTICS (NOTE 1)

$T_A = 25^\circ C$, $V_{CC} = 3.6V$, unless otherwise noted.

Symbol	Parameter	Condition	Min.	Typ.	Max.	Unit
P_O	Output power	THD+N = 1%, $R_L = 32\Omega$, $f = 1kHz$		30		mW
THD+N	Total harmonic distortion plus noise	$P_O = 20mW$, $R_L = 32\Omega$, $f = 1kHz$		0.024		%
t_{WU}	Wake-up time from shutdown			39		ms
PSRR	Power supply rejection ratio	$V_{P-P} = 200mV$, $R_L = 32\Omega$, $f = 217Hz$		-95		dB
		$V_{P-P} = 200mV$, $R_L = 32\Omega$, $f = 1kHz$		-93		dB
V_{NO}	Output voltage noise			7		μV
SNR	Signal-to-noise ratio	$P_O = 30mW$, THD+N = 0.1%		103		dB

Note 1: Guaranteed by design.

TYPICAL PERFORMANCE CHARACTERISTIC

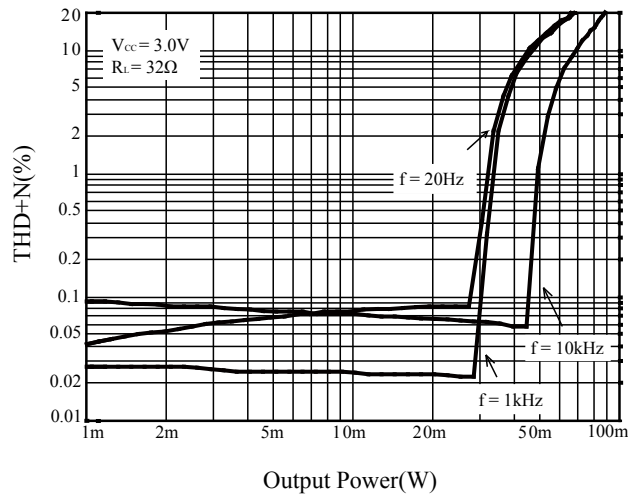

Figure 2 THD+N vs. Output Power

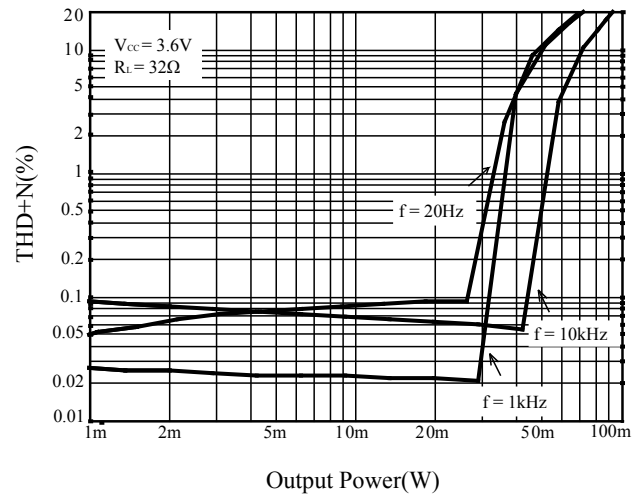

Figure 3 THD+N vs. Output Power

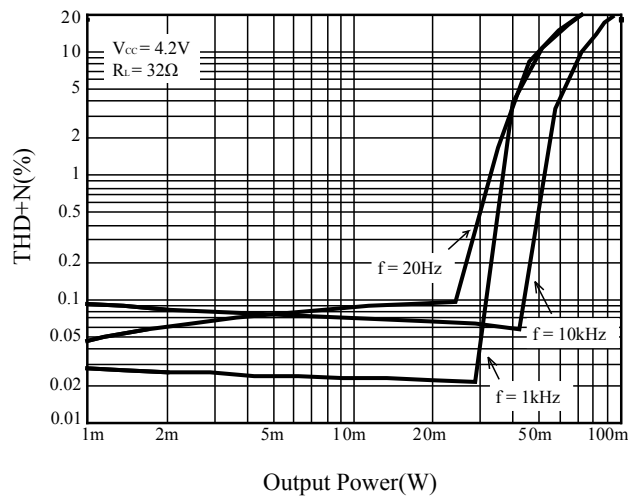

Figure 4 THD+N vs. Output Power

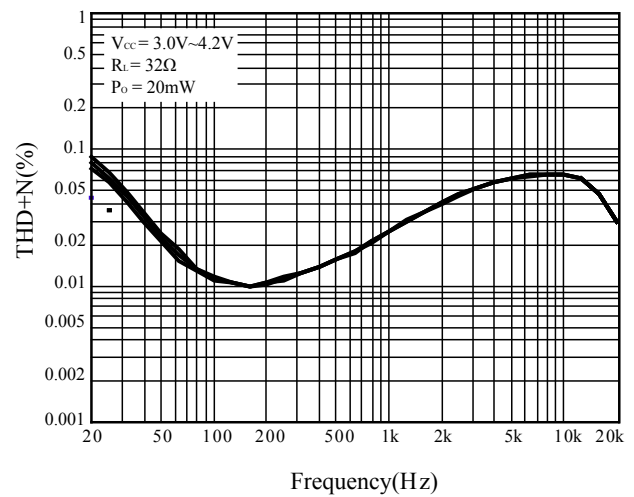

Figure 5 THD+N vs. Frequency

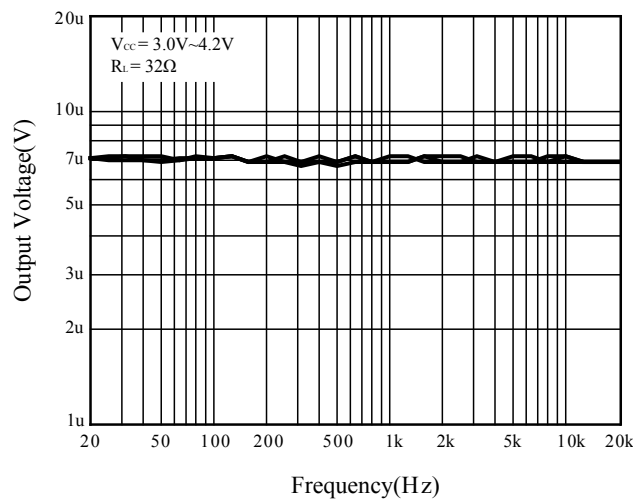

Figure 6 Noise

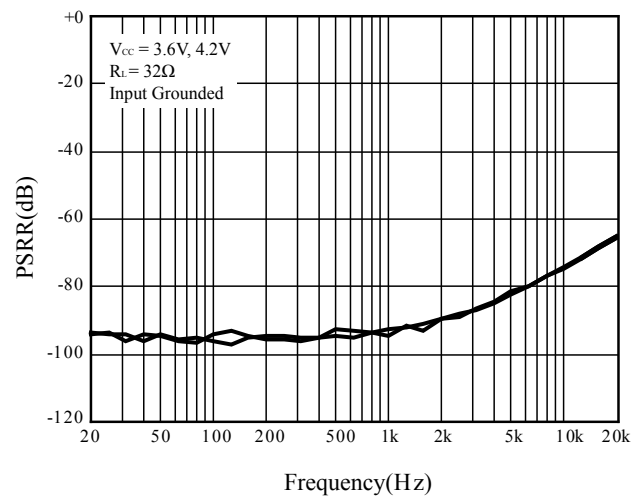

Figure 7 PSRR vs. Frequency

IS31AP4912

APPLICATION INFORMATION

CHARGE PUMP CONVERTER

IS31AP4912 integrate a charge pump converter to change input supply voltage (V_{CC}) into a negative voltage providing a 0V reference voltage for output.

The charge pump converter only needs three external components: supply decoupling capacitor, output bypass capacitor and flying capacitor.

Choose low ESR capacitors to ensure the best operating performance and place the capacitors as close as possible to the IS31AP4912.

GAIN SETTING

The input resistors (R_{IN}) and feedback resistors (R_F) set the gain of the amplifier according to Equation (1).

$$Gain = \frac{R_F}{R_{IN}} \left(\frac{V}{V} \right) \quad (1)$$

For example, in figure 1:

$R_F = 20k\Omega$, $R_{IN} = 20k\Omega$,

so,
$$Gain = \frac{20}{20} = 1 \left(\frac{V}{V} \right)$$

Resistor matching is very important in the amplifiers. The balance of the output on the reference voltage depends on matched ratios of the resistors. CMRR, PSRR, and cancellation of the second harmonic distortion diminish if resistor mismatch occurs. Therefore, it is recommended to use 1% tolerance resistors or better to keep the performance optimized. Matching is more important than overall tolerance. Resistor arrays with 1% matching can be used with a tolerance greater than 1%.

Place the input resistors very close to the IS31AP4912 to limit noise injection on the high-impedance nodes.

INPUT CAPACITOR (C_{IN})

The input capacitors and input resistors form a high pass filter with the corner frequency, f_c , determined in Equation (2).

$$f_c = \frac{1}{2\pi R_{IN} C_{IN}} \quad (2)$$

For example, in figure 1:

$R_{IN} = 20k\Omega$, $C_{IN} = 0.47\mu F$,

so,
$$f_c = \frac{1}{2\pi \times 20k\Omega \times 0.47\mu F} \approx 17Hz$$

The value of the input capacitor is important to consider as it directly affects the bass (low frequency) performance of the circuit. The capacitors should have a tolerance of $\pm 10\%$ or better, because any mismatch in capacitance causes an impedance mismatch at the corner frequency and below.

DESIGN NOTE

COMPONENT SELECTION

The value and ESR of the output capacitor for charge pump will affect output ripple and transient performance. A X7R or X5R ceramic capacitor in $2.2\mu F$ should be recommended. The flying capacitor should use a $2.2\mu F$ X7R or X5R ceramic capacitor.

All the capacitors should support at least 10V.

PCB LAYOUT

The decoupling capacitors should be placed close to the VCC pin and the output capacitors should be placed close to the VSS pin. The flying capacitor should be placed close to the CN and CP pins. The input capacitors and input resistors should be placed close to the INR and INL pins and the traces must be parallel to prevent noise. The traces of OUTR and OUTL pins connected to the headphone should be as possible as short and wide. The recommended width is 0.5mm.

Trace width should be at least 0.75mm for the power supply and the ground plane. The SGND and PGND pins of the IS31AP4912 must be routed separately back to the decoupling capacitor in order to provide proper device operation. If the SGND and PGND pins are connected directly to each other, the part functions without risk of failure, but the noise and THD performance do not meet the specifications.

IS31AP4912

CLASSIFICATION REFLOW PROFILES

Profile Feature	Pb-Free Assembly
Preheat & Soak Temperature min (T _{smin}) Temperature max (T _{smax}) Time (T _{smin} to T _{smax}) (t _s)	150°C 200°C 60-120 seconds
Average ramp-up rate (T _{smax} to T _p)	3°C/second max.
Liquidous temperature (T _L) Time at liquidous (t _L)	217°C 60-150 seconds
Peak package body temperature (T _p)*	Max 260°C
Time (t _p)** within 5°C of the specified classification temperature (T _c)	Max 30 seconds
Average ramp-down rate (T _p to T _{smax})	6°C/second max.
Time 25°C to peak	8 minutes max.

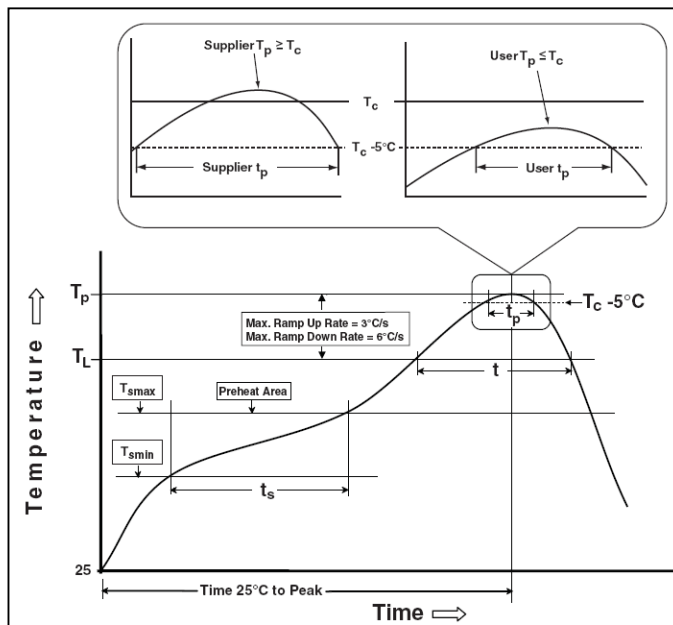
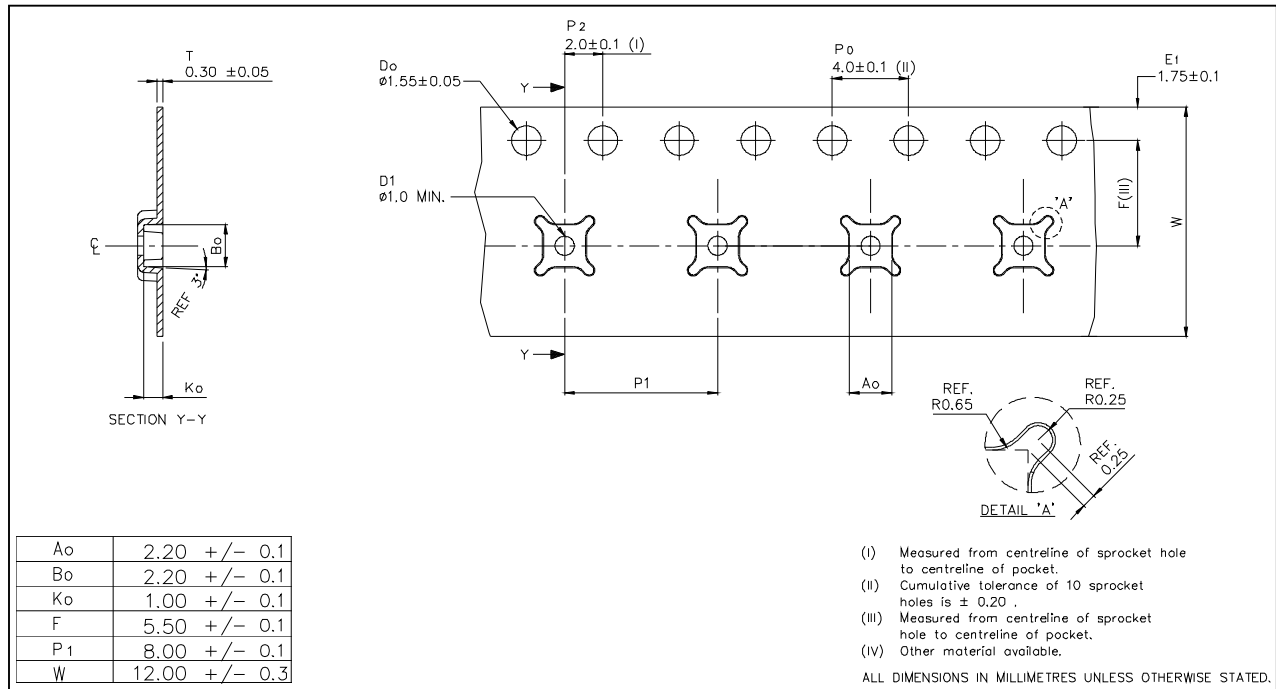

Figure 8 Classification Profile

IS31AP4912

TAPE AND REEL INFORMATION



IS31AP4912

PACKAGING INFORMATION

UTQFN-12

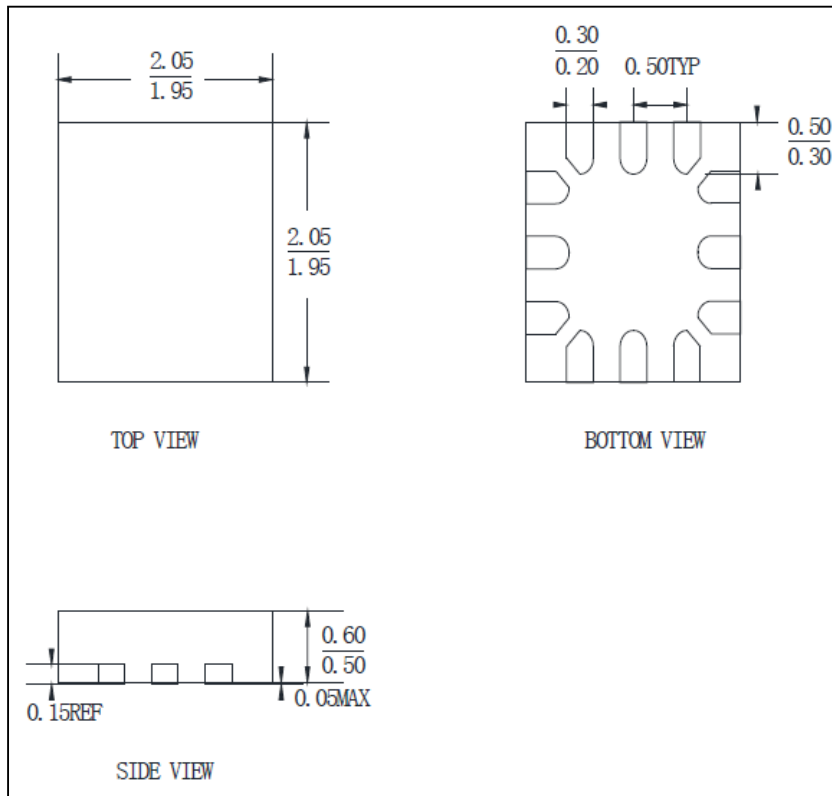

Note: All dimensions in millimeters unless otherwise stated.

Данный компонент на территории Российской Федерации

Вы можете приобрести в компании MosChip.

Для оперативного оформления запроса Вам необходимо перейти по данной ссылке:

<http://moschip.ru/get-element>

Вы можете разместить у нас заказ для любого Вашего проекта, будь то серийное производство или разработка единичного прибора.

В нашем ассортименте представлены ведущие мировые производители активных и пассивных электронных компонентов.

Нашей специализацией является поставка электронной компонентной базы двойного назначения, продукции таких производителей как XILINX, Intel (ex.ALTERA), Vicor, Microchip, Texas Instruments, Analog Devices, Mini-Circuits, Amphenol, Glenair.

Сотрудничество с глобальными дистрибьюторами электронных компонентов, предоставляет возможность заказывать и получать с международных складов практически любой перечень компонентов в оптимальные для Вас сроки.

На всех этапах разработки и производства наши партнеры могут получить квалифицированную поддержку опытных инженеров.

Система менеджмента качества компании отвечает требованиям в соответствии с ГОСТ Р ИСО 9001, ГОСТ РВ 0015-002 и ЭС РД 009

Офис по работе с юридическими лицами:

105318, г.Москва, ул.Щербаковская д.3, офис 1107, 1118, ДЦ «Щербаковский»

Телефон: +7 495 668-12-70 (многоканальный)

Факс: +7 495 668-12-70 (доб.304)

E-mail: info@moschip.ru

Skype отдела продаж:

moschip.ru

moschip.ru_4

moschip.ru_6

moschip.ru_9