

DUAL OPERATIONAL TRANSCONDUCTANCE AMPLIFIER

■ GENERAL DESCRIPTION

The NJM13600/13700 consist of two current controlled trans conductance amplifiers each with differential inputs and a push pull output. The two amplifiers share common supplies but otherwise operate independently. Linearizing diodes are provided at the inputs to reduce distortion and allow higher input levels. The result is a 10 dB signal-to-noise improvement referenced to 0.5 percent THD. Controlled impedance buffers are provided which are especially designed to complement the dynamic range of the amplifiers.

■ PACKAGE OUTLINE



NJM13600D
NJM13700D



NJM13600M
NJM13700M

■ FEATURES

- Package Outline DIP16,DMP16
- Bipolar Technology

■ PIN CONFIGURATION

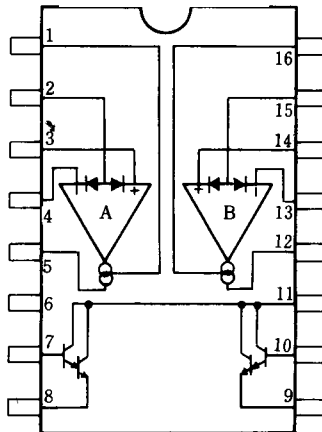

NJM13600D,NJM13600M
NJM13700D,NJM13700M

PIN FUNCTION

- | | |
|---------------------|----------------------|
| 1. AMP BIAS INPUT A | 9. BUFFER OUTPUT B |
| 2. DIODE BIAS A | 10. BUFFER INPUT B |
| 3. +INPUT | 11. V ⁺ |
| 4. -INPUT | 12. OUTPUT B |
| 5. OUTPUT A | 13. -INPUT B |
| 6. V ⁻ | 14. +INPUT B |
| 7. BUFFER INPUT A | 15. DIODE BIAS B |
| 8. BUFFER OUTPUT A | 16. AMP BIAS INPUT B |

■ EQUIVALENT CIRCUIT

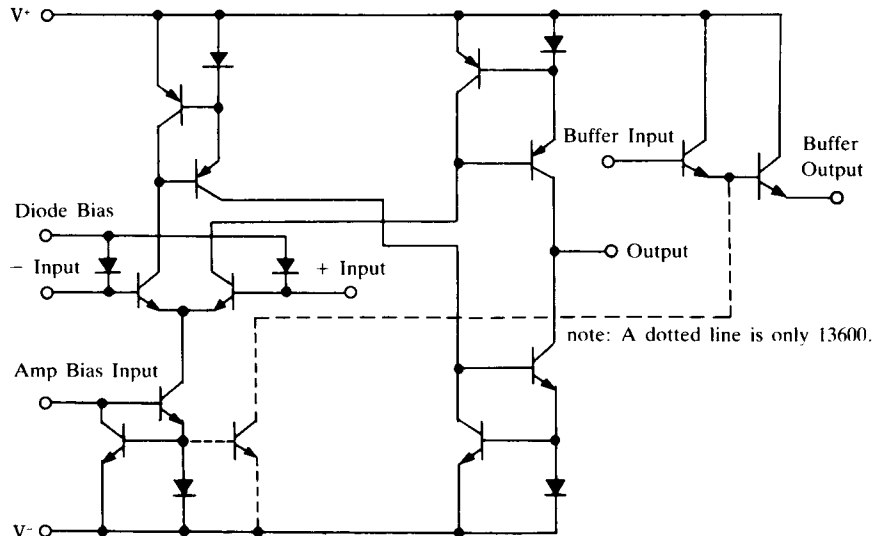

NJM13600/13700

■ ABSOLUTE MAXIMUM RATINGS

(Ta=25°C)

PARAMETER	SYMBOL	RATINGS	UNIT
Supply Voltage	V ⁺ /V	36 or ±18	V
Differential Input Voltage	V _{ID}	± 5	V
Diode Bias Current	I _D	2	mA
Amp Bias Current	I _{ABC}	2	mA
Buffer Output Current	I _O	20	mA
Power Dissipation	P _D	(DIP16) 570 (DMP16) 700 (note)	mW
DC Input Voltage	V _{IN}	V ⁺ ~V	V
Operating Temperature Range	T _{opr}	-40~+85	°C
Storage Temperature Range	T _{stg}	-40~+125	°C

(note) At on a ceramic PCB (10x20x0.635 mm)

■ ELECTRICAL CHARACTERISTICS

(V⁺/V=±15V, Ta=25°C, I_{ABC}=500μA)

PARAMETER	SYMBOL	TEST CONDITION	13600			13700			UNIT
			MIN.	TYP.	MAX.	MIN.	TYP.	MAX.	
Input Offset Voltage (V _{OS})	V _{IO}		-	0.4	5	-	0.4	4	mV
Input Offset Voltage		I _{ABC} =5μA	-	0.3	5	-	0.3	4	mV
V _{OS} Including Diodes		Diode Bias Current, I _D =500μA	-	0.5	5	-	0.5	5	mV
Input Offset Change		5μA ≤ I _{ABC} ≤ 500μA	-	0.1	-	-	0.1	3	mV
Input Bias Current	I _B		-	0.4	5	-	0.4	5	μA
Input Bias Current		(-20~+75°C)	-	1	8	-	1	8	μA
Forward Transconductance	gm		6700	9600	13000	6700	9600	13000	μS
		(-20~+75°C)	5400	-	-	5400	-	-	μS
gm Tracking		R _L =0, I _{ABC} =5μA	-	0.3	-	-	0.3	-	dB
Peak Output Current	I _{OP}	R _L =0, I _{ABC} =5μA	-	5	-	-	0	-	μA
Peak Output Current		R _L =0, I _{ABC} =500μA	350	500	650	350	500	650	μA
Peak Output Current		R _L =0 (-20~+75°C)	300	-	-	300	-	-	μA
Peak Output Voltage Positive	V _{OP}	R _L =∞, 5μA ≤ I _{ABC} ≤ 500μA	+12	+14.2	-	+12	+14.2	-	V
Peak Output Voltage Negative		R _L =∞, 5μA ≤ I _{ABC} ≤ 500μA	-12	-14.4	-	-12	-14.4	-	V
Operating Current	I _{CC}	I _{ABC} =500μA, two circuit	-	2.6	-	-	2.6	-	mA
V _{OS} Sensitivity Positive	SVR	ΔV _{OS} /ΔV ⁺	76.5	94	-	76.5	94	-	dB
V _{OS} Sensitivity Negative		ΔV _{OS} /ΔV ⁻	76.5	94	-	76.5	94	-	dB
Input Offset Current	I _{IO}		-	0.1	0.6	-	0.1	0.6	μA
CMRR	CMR		80	110	-	80	110	-	dB
Common Mode Range	V _{ICM}		± 12	± 13.5	-	± 12	± 13.5	-	V
Cross Talk	CT	20Hz<f<20kHz (note2)	-	-100	-	-	-100	-	dB
Differential Input Current	I _{ID}	I _{ABC} =0, Input=±4V	-	0.02	100	-	0.02	100	nA
Leakage Current	I _{LEAK}	I _{ABC} =0(Refer to Test Circuit)	-	0.2	100	-	0.2	100	nA
Input Resistance	R _{IN}		10	26	-	10	26	-	kΩ
Open Loop Bandwidth			-	2	-	-	2	-	MHz
Slew Rate	SR		-	50	-	-	50	-	V/μs
Buffer Input Current		(note2)	-	0.4	5	-	0.4	5	μA
Peak Buffer Output Voltage		(note2)	10	-	-	10	-	-	V

(note1) Open unless otherwise specified. The inputs to the buffers are grounded and outputs are open.

(note2) R_{OUT}=5kΩ connected from the buffer output to V⁺ and the input of buffer is connected to the transconductance amplifier output.

I_{ABC}=500μA

■ TEST CIRCUIT



Differential Input Current



Leakage Current

■ TYPICAL APPLICATIONS



■ TYPICAL CHARACTERISTICS

Distortion vs. Differential Input Voltage

($V^+/V^- = \pm 15V$, $R_L = 10k\Omega$, $I_{ABC} = 1mA$, $T_a = 25^\circ C$)

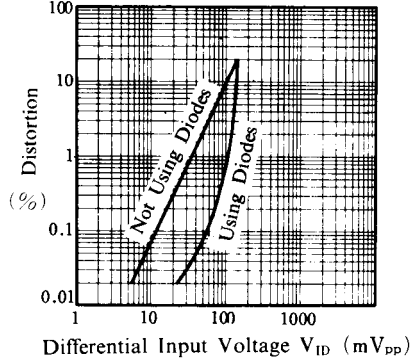

Voltage vs. Amplifier Bias Current

($V^+/V^- = \pm 15V$, $R_L = 10k\Omega$, $T_a = 25^\circ C$)

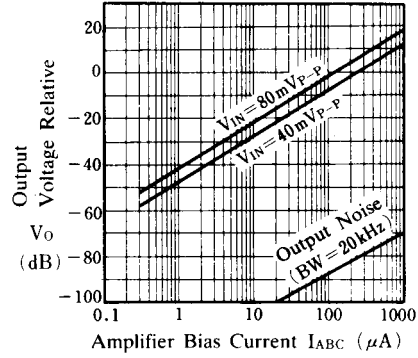

Output Noise Current vs. Frequency

($T_a = 25^\circ C$)

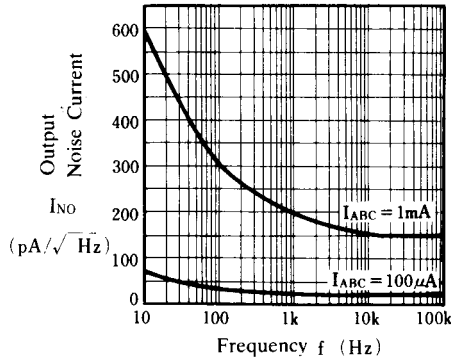

■ TYPICAL CHARACTERISTICS

Input Offset Voltage

($V^+/V^- = \pm 15V$, $T_a = 25^\circ C$)

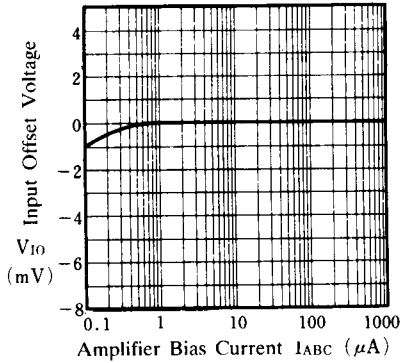

Input Offset Current

($V^+/V^- = \pm 15V$, $T_a = 25^\circ C$)

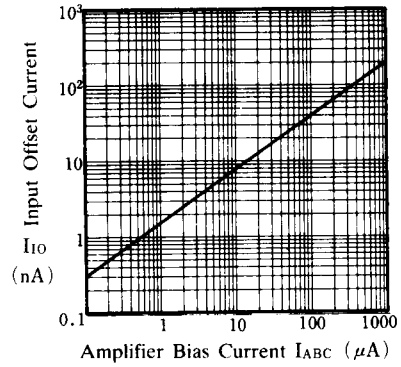

Input Bias Current

($V^+/V^- = \pm 15V$, $T_a = 25^\circ C$)

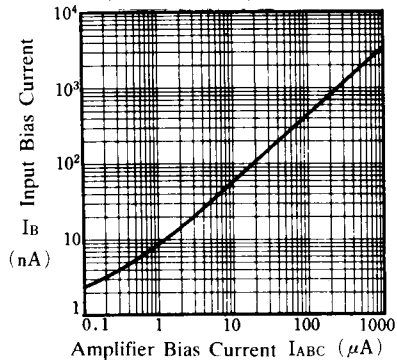

Peak Output Current

($V^+/V^- = \pm 15V$, $T_a = 25^\circ C$)

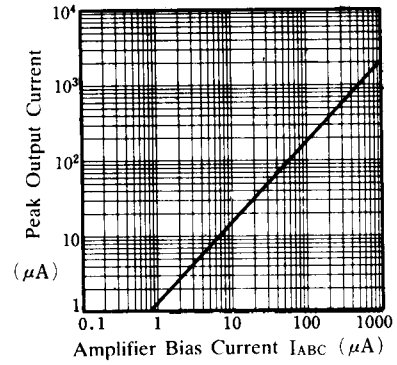

Peak Output Voltage and Common Mode Range

($V^+/V^- = \pm 15V$, $R_L = \infty$, $T_a = 25^\circ C$)

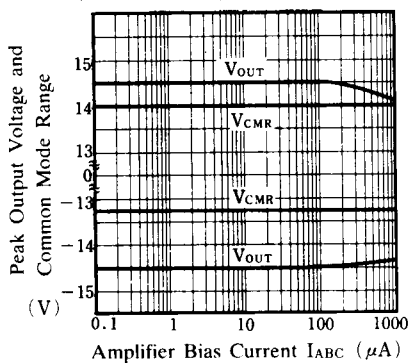

Leakage Current vs. Temperature

($+V_{IN} = -V_{IN} = V_O$)

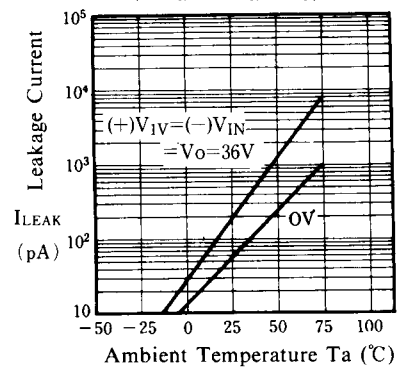

NJM13600/13700

■ TYPICAL CHARACTERISTICS

Input Leakage Current
($T_a = 25^\circ\text{C}$)



Transconductance



Input Resistance

(Pin2.15 Open, $T_a = 25^\circ\text{C}$)

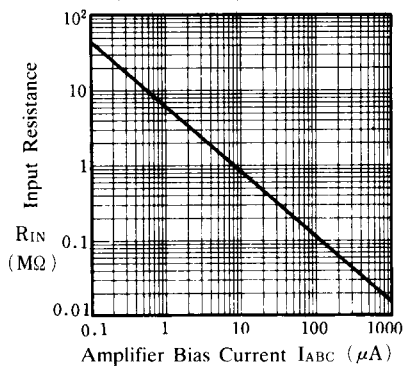

Amplifier Bias Voltage

vs. Amplifier Bias Current

($T_a = 25^\circ\text{C}$)

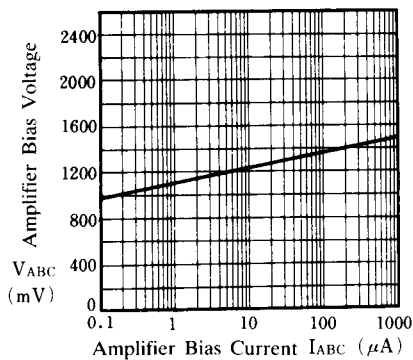

Input and Output Capacitance

($V^+/V^- = \pm 15\text{V}$, $T_a = 25^\circ\text{C}$)

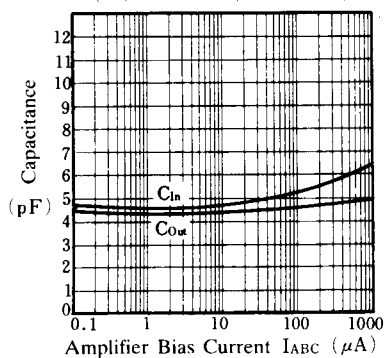

Output Resistance

($T_a = 25^\circ\text{C}$)

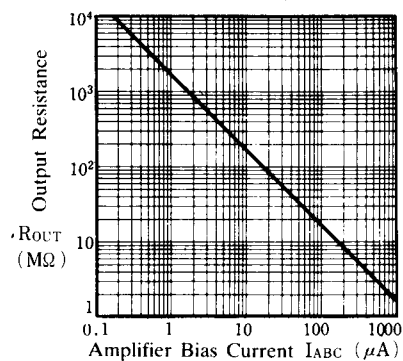

[CAUTION]

The specifications on this databook are only given for information, without any guarantee as regards either mistakes or omissions. The application circuits in this databook are described only to show representative usages of the product and not intended for the guarantee or permission of any right including the industrial rights.

Данный компонент на территории Российской Федерации

Вы можете приобрести в компании MosChip.

Для оперативного оформления запроса Вам необходимо перейти по данной ссылке:

<http://moschip.ru/get-element>

Вы можете разместить у нас заказ для любого Вашего проекта, будь то серийное производство или разработка единичного прибора.

В нашем ассортименте представлены ведущие мировые производители активных и пассивных электронных компонентов.

Нашей специализацией является поставка электронной компонентной базы двойного назначения, продукции таких производителей как XILINX, Intel (ex.ALTERA), Vicor, Microchip, Texas Instruments, Analog Devices, Mini-Circuits, Amphenol, Glenair.

Сотрудничество с глобальными дистрибьюторами электронных компонентов, предоставляет возможность заказывать и получать с международных складов практически любой перечень компонентов в оптимальные для Вас сроки.

На всех этапах разработки и производства наши партнеры могут получить квалифицированную поддержку опытных инженеров.

Система менеджмента качества компании отвечает требованиям в соответствии с ГОСТ Р ИСО 9001, ГОСТ РВ 0015-002 и ЭС РД 009

Офис по работе с юридическими лицами:

105318, г.Москва, ул.Щербаковская д.3, офис 1107, 1118, ДЦ «Щербаковский»

Телефон: +7 495 668-12-70 (многоканальный)

Факс: +7 495 668-12-70 (доб.304)

E-mail: info@moschip.ru

Skype отдела продаж:

moschip.ru

moschip.ru_4

moschip.ru_6

moschip.ru_9