

PWM 3-PHASE DC BRUSHLESS MOTOR CONTROL IC

□ GENERAL DESCRIPTION

The NJM2626 is a 3-phase DC brush less motor control pre-driver IC with PWM control.

It takes hall IC inputs and generates motor driving waveform.

Output pre-driver is optimized to work with external power MOS transistors for better power handling.

The NJM2626 can easily implement 3-phase DC motor application with speed control feature.

□ Package Outline

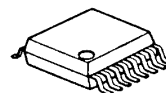

NJM2626V

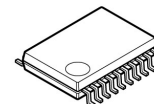

NJM2626VC3

- Operating Voltage V_{cc}= 6V to 26V
- Pre-driver circuit
 - Lower arm: I_{out}=+30mA/-30mA TYP.
 - Upper arm: I_{out}=30mA TYP.
- Current limit sensing voltage Current limit=0.5V±10%
- Internal Oscillator
 - Frequency control by external capacitor
- Forward or Reverse direction Internal pull-up resistor 10kΩ
- Internal Soft Start
 - External capacitor to V_{err} pin
- Internal ON/OFF Circuit
 - No-output is V_{err} pin to GND
- Bipolar Technology
- Package Outline SSOP-16/ SSOP20-C3

NJM2626

□ ABSOLUTE MAXIMUM RATINGS

(Ta=25°C)

PARAMETER	SYMBOL	RATINGS		UNIT
Logic Supply Voltage	V _{CC}	28		V
Maximum Output Current	I _O MAX	40		mA
Power Dissipation (SSOP-16)	P _D	Without Board	300	mW
		(*1) Mounted on the 2 layered PCB	640	
Power Dissipation (SSOP20-C3)	P _D	(*1) Mounted on the 2 layered PCB	1000	mW
		(*1) Mounted on the 4 layered PCB	1500	
Operating Temperature Range	Topr	-40 ~ +85		°C
Storage Temperature range	Tstg	-50 ~ +150		°C

(*1): Mounted on the glass epoxy board based on EIA/JEDEC. (114.3x76.2x1.6mm: 2Layer/4Layer)

□ ELECTRICAL CHARACTERISTICS

(V_{CC}=12V, C_t=1000pF, C_{ref}=1μF, T_a=25°C)

PARAMETER	SYMBOL	TEST CONDITION	MIN.	TYP.	MAX.	UNIT
□ General						
Operation Supply Voltage	V _{CC}	-	6.0	-	26.0	V
Under Voltage Sense Voltage	UVLO	Output Enable V _{CC} Decreasing	4.5	5.0	5.5	V
Hysteresis Voltage (Under Voltage Lock Out)	ΔUVLO	-	0.35	0.45	0.55	V
Supply Current	I _{CC}	R _L =∞	-	12.0	18.0	mA
□ Reference Voltage Section						
Reference Voltage Output	V _{ref}	I _{ref} =1.0mA	3.6	4.0	4.4	V
Line Regulation	ΔV _{ref_LI}	V _{CC} =6V ~ 18V	-	50	100	mV
Load Regulation	ΔV _{ref_LO}	I _{ref} =1.0mA ~ 20.0mA	-	10	50	mV
□ Hall Amplifier Section						
Input H Level Voltage	V _{hH}	-	V _{CC} -0.8	-	-	V
Input L Level Voltage	V _{hL}	-	-	-	0.8	V
Input Bias Voltage	I _{ho}	V _{in} =0.8V	-	-	-400	nA
Pull-up Resistance	R _{PUH}	V _{in} =0.8V	7	10	13	kΩ
□ Output Section						
Under Arm Output Voltage 1	V _{OH(D)}	I _{source} =30mA	10	10.3	-	V
Under Arm Output Voltage 2	V _{OL(D)}	I _{sink} =30mA	-	0.5	1.0	V
Output Clamp Voltage	V _{CL(D)}	V _{CC} =26V	-	18	20	V
Upper Arm Output Voltage	V _{OL(U)}	I _{sink} =30mA	-	0.5	1.0	V
Output Leak Current	I _{OLEAK}	-	-	-	1.0	μA
□ Over Current Sense Section						
Sense Voltage	V _{TH}	-	0.45	0.50	0.55	V
Hysteresis Voltage	V _{THhys}	-	-	0.1	-	V
Input Voltage Ratio	V _{IN}	-	-	-	3.0	V
Input Bias Current	I _{IB}	V _{IN} =0V	-	-0.9	-5.0	μA
□ Oscillator Section						
Oscillation Frequency	f _{osc}	-	22	27	33	kHz
Supply Voltage Change Ratio	Δf _{osc} /ΔV	V _{CC} =6V ~ 18V	-	1	5	%
PWM0% Sense Voltage	PWM0	PWM DUTY=0%	-	-	0.35	V
PWM100% Sense Voltage	PWM1	PWM DUTY=100%	3.5	-	-	V
Saw Wave Peak Voltage	V _p fosc	-	2.4	2.8	3.2	V
Saw Wave Bottom Voltage	V _b fosc	-	0.75	0.9	1.05	V

NJM2626

□ ELECTRICAL CHARACTERISTICS

($V_{CC}=12V$, $C_t=1000pF$, $C_{ref}=1\mu F$, $T_a=25^\circ C$)

PARAMETER	SYMBOL	TEST CONDITION	MIN.	TYP.	MAX.	UNIT
□ Error Amplifier Section						
Input Offset Voltage	V_{IO}	-	-	7	-	mV
Input Bias Current	I_{IBRR}	-	-	-46	-	nA
Input Common Mode Voltage Range	V_{ICMRR}	-	0	-	Vref	V
□ Forward/ Reverse Direction Section (FR input terminal)						
Output Forward Direction	V_F	-	Vref-0.8	-	Vref	V
Output Reverse Direction	V_R	-	-	-	0.8	V
Hysteresis Voltage Ratio	ΔV_{FR}	-	-	0.5	-	V
Pull-Up Resistance	$R_{PU_{FR}}$	-	7	10	13	k Ω

Note: Output switch test are performed under pulsed conditions to minimize power dissipation.

■ HALL INPUT vs HALL OUTPUT TRUTH TABLE

FR=L			FR=H			H:Source, L:Sink, X:Hi-Z					
H1	H2	H3	H1	H2	H3	UH	VH	WH	UL	VL	WL
H	L	H	L	H	L	X	L	X	H	L	L
H	L	L	L	H	H	X	X	L	H	L	L
H	H	L	L	L	H	X	X	L	L	H	L
L	H	L	H	L	H	L	X	X	L	H	L
L	H	H	H	L	L	L	X	X	L	L	H
L	L	H	H	H	L	X	L	X	L	L	H

■ FR INPUT TERMINAL

Terminal Voltage	Direction
L input	F
H input	R

□ PIN CONFIGURATION

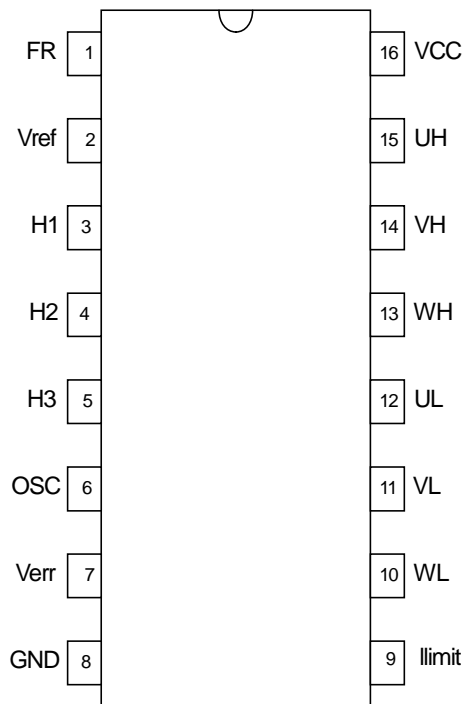

SSOP-16

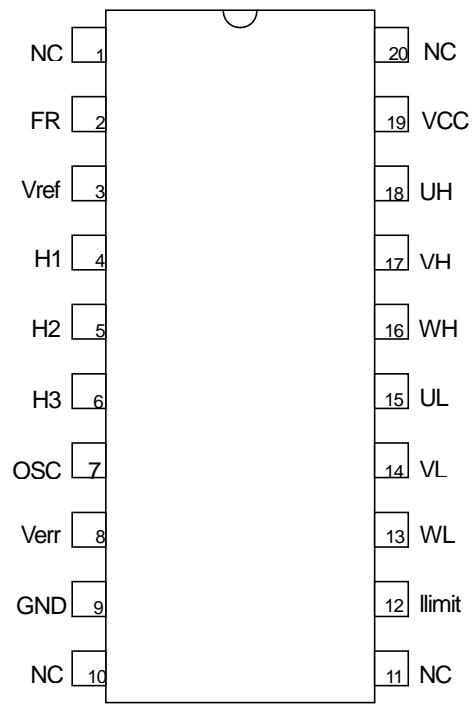

SSOP20-C3

NJM2626

□ BLOCK DIAGRAM

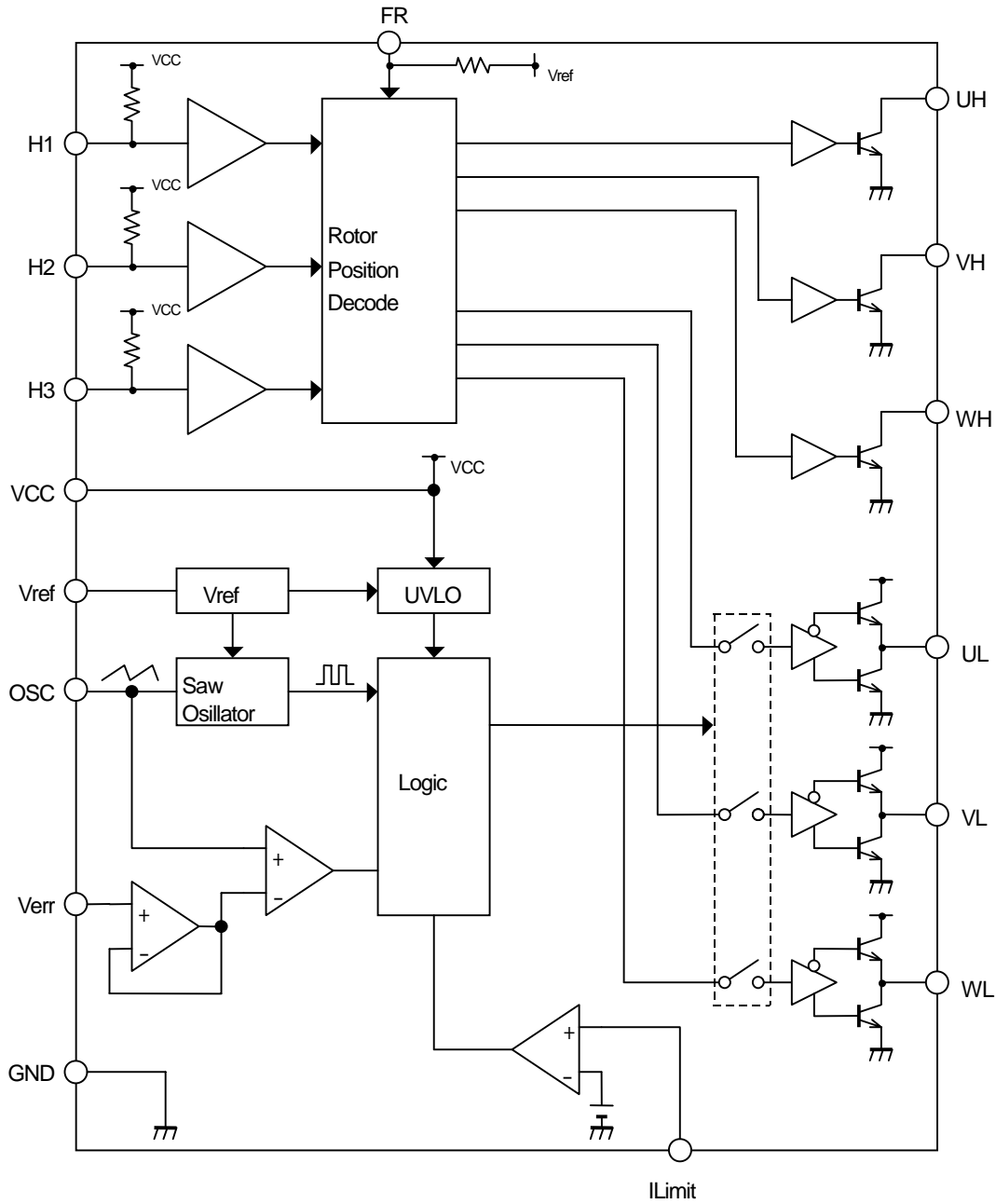

TYPICAL CHARACTERISTICS

ICC vs. VCC

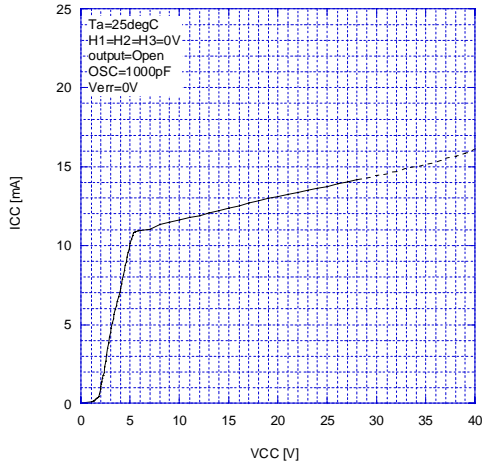

ICC vs. Temperature

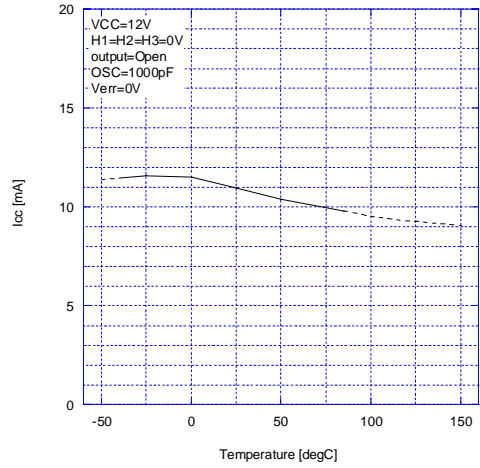

UVLO vs. Temperature

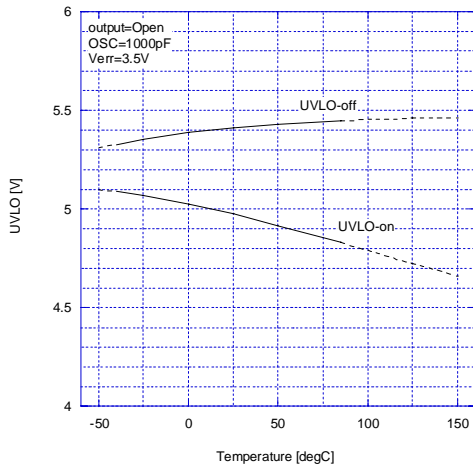

dUVLO vs. Temperature

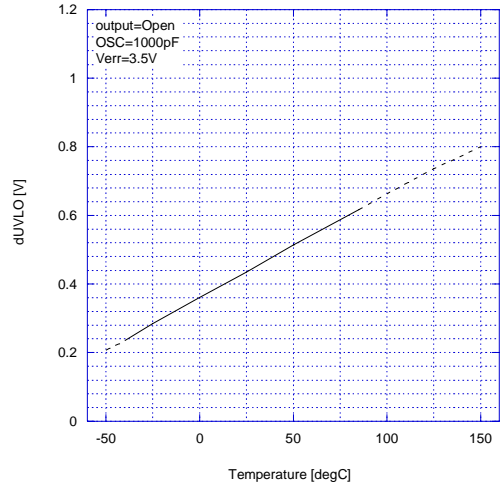

Vref vs. VCC

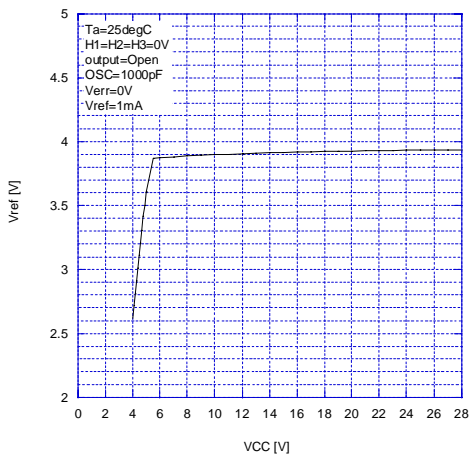

Vref vs. Io

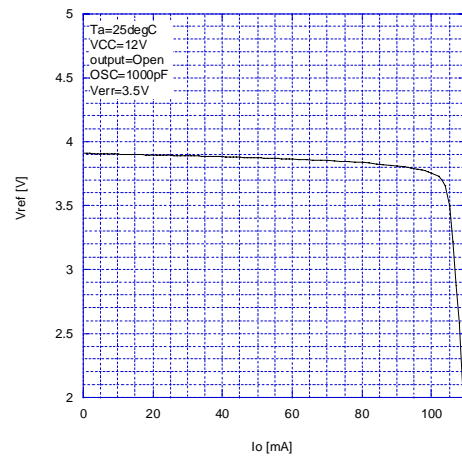

TYPICAL CHARACTERISTICS

Vref vs. Temperature

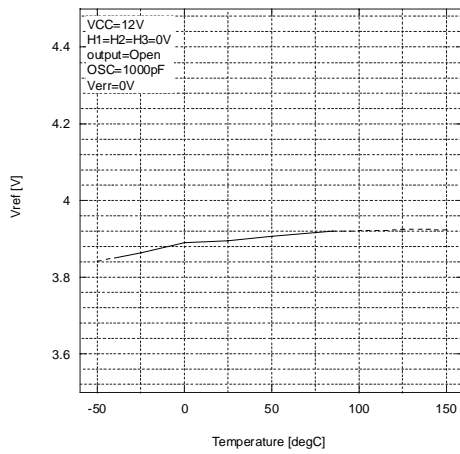

dVFR vs. Temperature

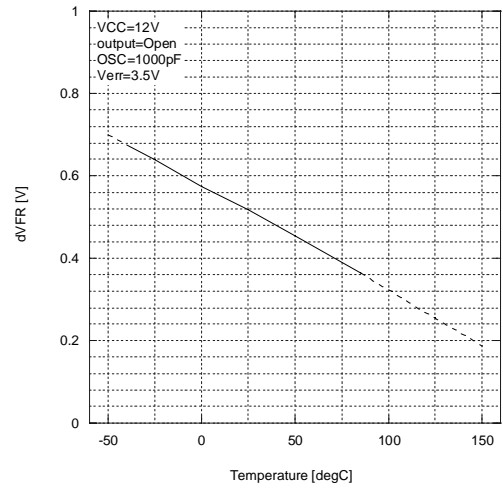

VhH-L vs. Temperature

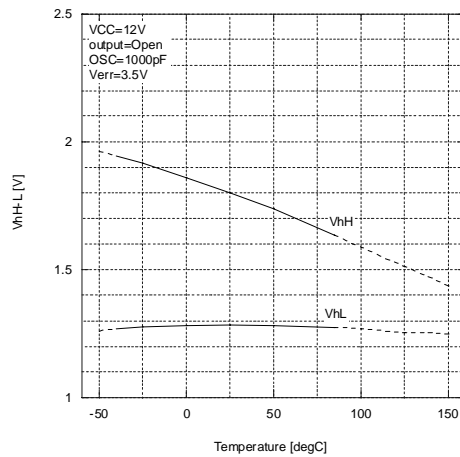

VOH(D) vs. Io

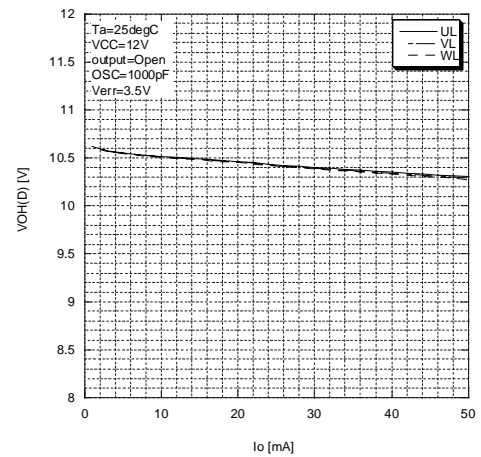

VOH-d vs. Temperature

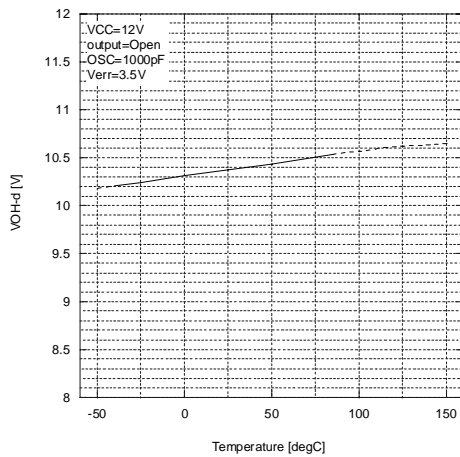

VOL(D) vs. Io

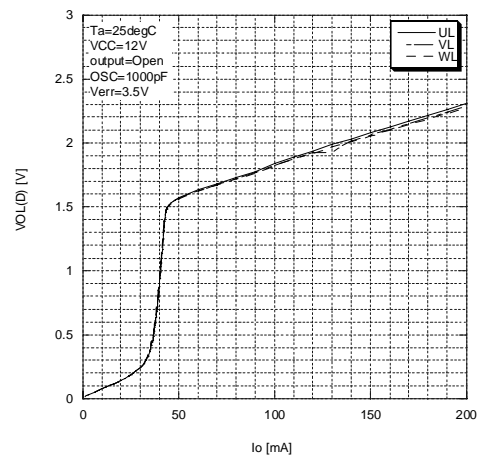

TYPICAL CHARACTERISTICS

VCL vs. Temperature

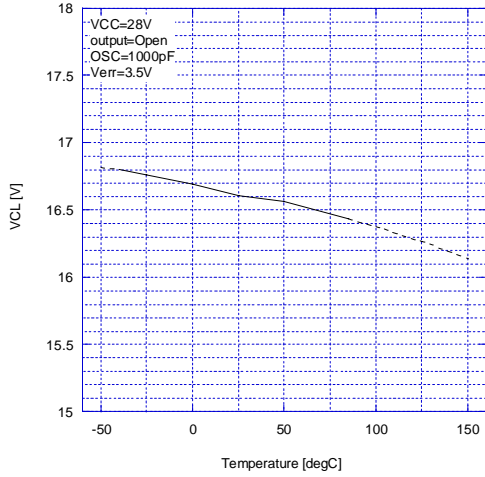

VTH vs. Temperature

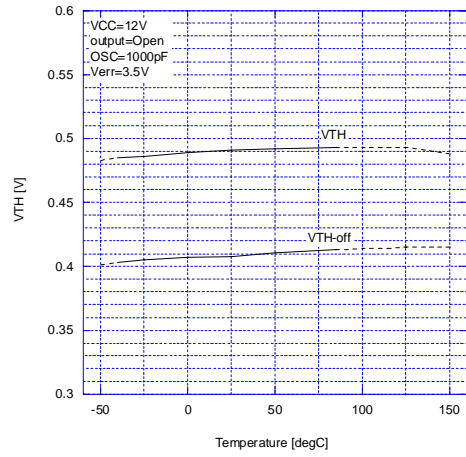

fosc vs. VCC

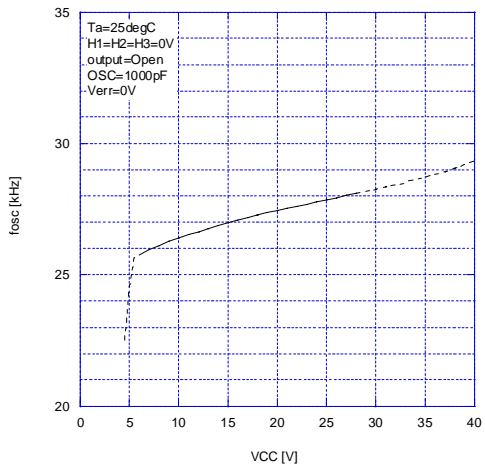

fosc vs. Temperature

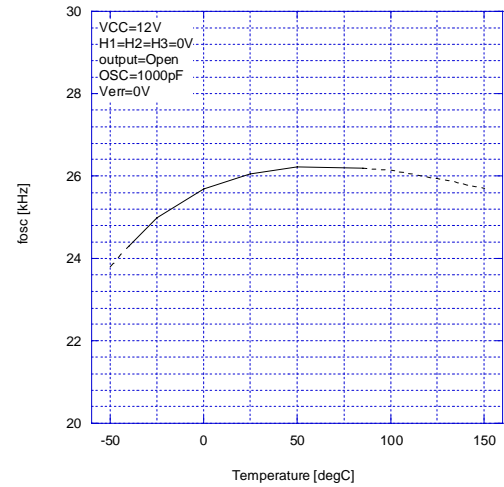

RPU-FR vs. Temperature

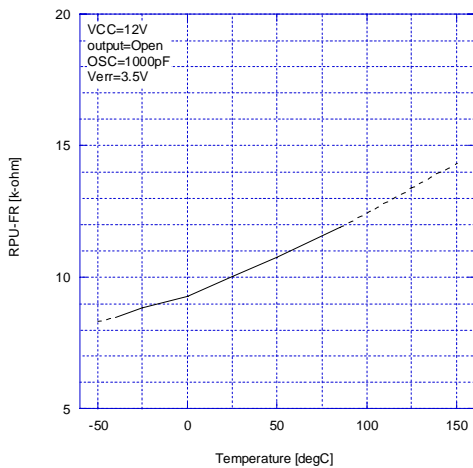

[CAUTION]

The specifications on this databook are only given for information, without any guarantee as regards either mistakes or omissions. The application circuits in this databook are described only to show representative usages of the product and not intended for the guarantee or permission of any right including the industrial rights.

Mouser Electronics

Authorized Distributor

Click to View Pricing, Inventory, Delivery & Lifecycle Information:

[NJR:](#)

[NJM2626V-TE1](#)

Данный компонент на территории Российской Федерации

Вы можете приобрести в компании MosChip.

Для оперативного оформления запроса Вам необходимо перейти по данной ссылке:

<http://moschip.ru/get-element>

Вы можете разместить у нас заказ для любого Вашего проекта, будь то серийное производство или разработка единичного прибора.

В нашем ассортименте представлены ведущие мировые производители активных и пассивных электронных компонентов.

Нашей специализацией является поставка электронной компонентной базы двойного назначения, продукции таких производителей как XILINX, Intel (ex.ALTERA), Vicor, Microchip, Texas Instruments, Analog Devices, Mini-Circuits, Amphenol, Glenair.

Сотрудничество с глобальными дистрибьюторами электронных компонентов, предоставляет возможность заказывать и получать с международных складов практически любой перечень компонентов в оптимальные для Вас сроки.

На всех этапах разработки и производства наши партнеры могут получить квалифицированную поддержку опытных инженеров.

Система менеджмента качества компании отвечает требованиям в соответствии с ГОСТ Р ИСО 9001, ГОСТ РВ 0015-002 и ЭС РД 009

Офис по работе с юридическими лицами:

105318, г.Москва, ул.Щербаковская д.3, офис 1107, 1118, ДЦ «Щербаковский»

Телефон: +7 495 668-12-70 (многоканальный)

Факс: +7 495 668-12-70 (доб.304)

E-mail: info@moschip.ru

Skype отдела продаж:

moschip.ru

moschip.ru_4

moschip.ru_6

moschip.ru_9