



### Main

Range of product	OsiSense XS
Series name	Application
Sensor type	Inductive proximity sensor
Device application	Food and beverage
Sensor name	XS9
Sensor design	Cylindrical M30
Size	64 mm
Body type	Single piece body
Enclosure material	Stainless steel 316L
Type of output signal	Discrete
Wiring technique	3-wire
[Sn] nominal sensing distance	0.79 in (20 mm)
Discrete output function	1 NO
Discrete output type	PNP
Electrical connection	4 pins M12 male connector
[Us] rated supply voltage	12...24 V DC with reverse polarity protection
Switching capacity in mA	<= 200 mA with overload and short-circuit protection
IP degree of protection	IP68 conforming to IEC 60529 IP69K conforming to DIN 40050

### Complementary

Thread type	M30 x 1.5
Detection face	Frontal
Detector flush mounting acceptance	Flush mountable
Material	Stainless steel 316L
Front material	Stainless steel 316L
Operating zone	> 0...0.63 in (> 0...16 mm)
Differential travel	1...15 % of Sr
Repeat accuracy	<= 5 % of Sr
Output circuit type	DC
Status LED	1 LED yellow output state
Supply voltage limits	10...30 V DC
Residual current	<= 0.1 mA for open state
Switching frequency	<= 100 Hz
Voltage drop	<= 2 V at closed state
Current consumption	<= 10 mA at no-load
Delay first up	<= 40 ms
Delay response	<= 0.00006 ms
Delay recovery	<= 0.015 ms
Marking	CE
Threaded length	1.65 in (42 mm)
Height	1.18 in (30 mm)
Length	2.52 in (64 mm)

### Environment

product certifications	CULus Ecolab
------------------------	-----------------

The information provided in this documentation contains general descriptions and/or technical characteristics of the products contained herein. This documentation is not intended as a substitute for and is not to be used for determining suitability or reliability of these products for specific user applications. It is the duty of any such user or integrator to perform the appropriate and complete risk analysis, evaluation and testing of the products with respect to the relevant specific application or use thereof. Neither Schneider Electric Industries SAS nor any of its affiliates or subsidiaries shall be responsible or liable for misuse of the information contained herein.

ambient air temperature for operation	-13...185 °F (-25...85 °C)
ambient air temperature for storage	-13...185 °F (-25...85 °C)
vibration resistance	25 gn amplitude = +/- 1 mm (f = 10...55 Hz) conforming to IEC 60068-2-6
shock resistance	30 gn 11 ms conforming to IEC 60068-2-27

## Offer Sustainability

Not Green Premium product	Not Green Premium product
Compliant - since 1206 - Schneider Electric declaration of conformity	Compliant - since 1206 - Schneider Electric declaration of conformity
Reference not containing SVHC above the threshold	Reference not containing SVHC above the threshold
WARNING: This product can expose you to chemicals including:	WARNING: This product can expose you to chemicals including:
Diisononyl phthalate (DINP), which is known to the State of California to cause cancer, and	Diisononyl phthalate (DINP), which is known to the State of California to cause cancer, and
Di-isodecyl phthalate (DIDP), which is known to the State of California to cause birth defects or other reproductive harm.	Di-isodecyl phthalate (DIDP), which is known to the State of California to cause birth defects or other reproductive harm.
For more information go to <a href="http://www.p65warnings.ca.gov">www.p65warnings.ca.gov</a>	For more information go to <a href="http://www.p65warnings.ca.gov">www.p65warnings.ca.gov</a>

## Contractual warranty

Warranty period	18 months
-----------------	-----------

## Dimensions

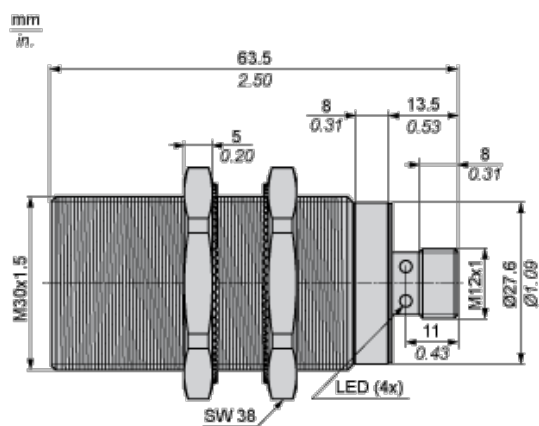

## Minimum Mounting Distances in mm

Side by side

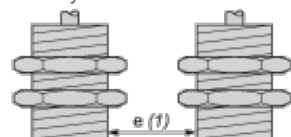

e (1) 80 mm/3.15 in.

≥

Face to face

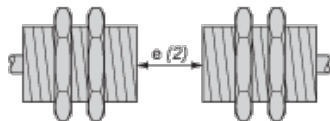

e (2) 70 mm/2.76 in.

≥

Facing a metal object

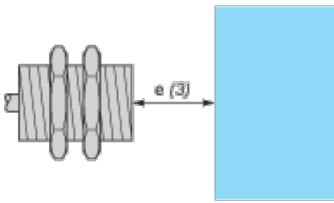

e (3) 60 mm/2.36 in.

≥

Mounted in a metal support

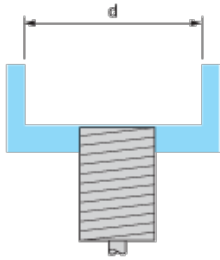

d ≥ 90 mm/3.54 in.

## Wiring Schemes

M12 connector

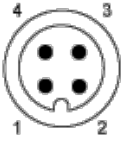

PNP

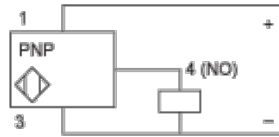

1 : (+)

2 : Not connected

3 : (-)

4 : NO Output

## Данный компонент на территории Российской Федерации

### Вы можете приобрести в компании MosChip.

Для оперативного оформления запроса Вам необходимо перейти по данной ссылке:

<http://moschip.ru/get-element>

Вы можете разместить у нас заказ для любого Вашего проекта, будь то серийное производство или разработка единичного прибора.

В нашем ассортименте представлены ведущие мировые производители активных и пассивных электронных компонентов.

Нашей специализацией является поставка электронной компонентной базы двойного назначения, продукции таких производителей как XILINX, Intel (ex.ALTERA), Vicor, Microchip, Texas Instruments, Analog Devices, Mini-Circuits, Amphenol, Glenair.

Сотрудничество с глобальными дистрибьюторами электронных компонентов, предоставляет возможность заказывать и получать с международных складов практически любой перечень компонентов в оптимальные для Вас сроки.

На всех этапах разработки и производства наши партнеры могут получить квалифицированную поддержку опытных инженеров.

Система менеджмента качества компании отвечает требованиям в соответствии с ГОСТ Р ИСО 9001, ГОСТ РВ 0015-002 и ЭС РД 009

### Офис по работе с юридическими лицами:

105318, г.Москва, ул.Щербаковская д.3, офис 1107, 1118, ДЦ «Щербаковский»

Телефон: +7 495 668-12-70 (многоканальный)

Факс: +7 495 668-12-70 (доб.304)

E-mail: [info@moschip.ru](mailto:info@moschip.ru)

Skype отдела продаж:

moschip.ru

moschip.ru\_4

moschip.ru\_6

moschip.ru\_9