

# COMLINEAR<sup>®</sup> CLC1002

## Ultra-Low Noise Amplifier

### FEATURES

- 0.6 nV/ $\sqrt{\text{Hz}}$  input voltage noise
- 1mV maximum input offset voltage
- 965MHz gain bandwidth product
- Minimum stable gain of 5
- 170V/ $\mu\text{s}$  slew rate
- 130mA output current
- -40°C to +125°C operating temperature range
- Fully specified at 5V and  $\pm 5\text{V}$  supplies
- CLC1002: Lead-free SOT23-6
- Future option CLC2002

### APPLICATIONS

- Transimpedance amplifiers
- Pre-amplifier
- Low noise signal processing
- Medical instrumentation
- Probe equipment
- Test equipment
- Ultrasound channel amplifier

### General Description

The COMLINEAR CLC1002(single) is a high-performance, voltage feedback amplifier with ultra-low input voltage noise, 0.6nV/ $\sqrt{\text{Hz}}$ . The CLC1002 provides 965MHz gain bandwidth product and 170V/ $\mu\text{s}$  slew rate making it well suited for high-speed data acquisition systems requiring high levels of sensitivity and signal integrity. This COMLINEAR high-performance amplifier also offers low input offset voltage.

The COMLINEAR CLC1002 is designed to operate from 4V to 12V supplies. It consumes only 13mA of supply current per channel and offers a power saving disable pin that disables the amplifier and decreases the supply current to below 225 $\mu\text{A}$ . The CLC1002 amplifier operates over the extended temperature range of -40°C to +125°C.

If larger bandwidth or slew rate is required, a higher minimum stable gain version is available, the CLC1001 offers a minimum stable gain of 10 with 2.1GHz GBWP and 410V/ $\mu\text{s}$  slew rate.

### Typical Application - Single Supply Photodiode Amplifier

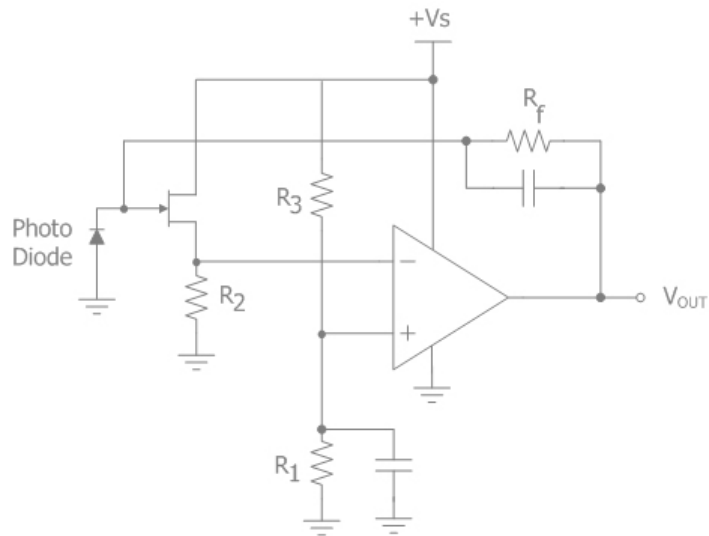

### Ordering Information

Part Number	Package	Pb-Free	RoHS Compliant	Operating Temperature Range	Packaging Method
CLC1002IST6X	SOT23-6	Yes	Yes	-40°C to +85°C	Reel
CLC1002ISO8X*	SOIC-8	Yes	Yes	-40°C to +85°C	Reel
CLC1002ISO8*	SOIC-8	Yes	Yes	-40°C to +85°C	Rail
CLC1002AST6X	SOT23-6	Yes	Yes	-40°C to +125°C	Reel
CLC1002ASO8X*	SOIC-8	Yes	Yes	-40°C to +125°C	Reel
CLC1002ASO8*	SOIC-8	Yes	Yes	-40°C to +125°C	Rail

\*Preliminary Product Information

Moisture sensitivity level for all parts is MSL-1.



## CLC1002 Pin Configuration

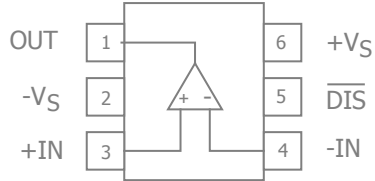

## CLC1002 Pin Assignments

Pin No.	Pin Name	Description
1	OUT	Output
2	-VS	Negative supply
3	+IN	Positive input
4	-IN	Negative input
5	$\overline{\text{DIS}}$	Disable. Enabled if pin is left floating or pulled above $V_{\text{ON}}$ , disabled if pin is grounded or pulled below $V_{\text{OFF}}$ .
6	+VS	Positive supply

## SOIC Pin Configuration

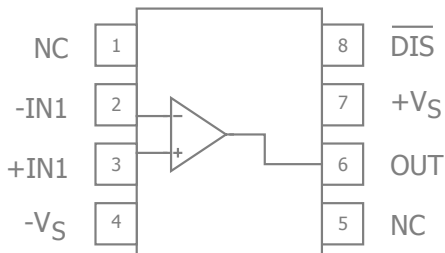

## SOIC Pin Assignments

Pin No.	Pin Name	Description
1	NC	No connect
2	-IN1	Negative input
3	+IN1	Positive input
4	-VS	Negative supply
5	NC	No connect
6	OUT	Output
7	+VS	Positive supply
8	$\overline{\text{DIS}}$	Disable. Enabled if pin is left floating or pulled above $V_{\text{ON}}$ , disabled if pin is grounded or pulled below $V_{\text{OFF}}$ .



## Absolute Maximum Ratings

The safety of the device is not guaranteed when it is operated above the "Absolute Maximum Ratings". The device should not be operated at these "absolute" limits. Adhere to the "Recommended Operating Conditions" for proper device function. The information contained in the Electrical Characteristics tables and Typical Performance plots reflect the operating conditions noted on the tables and plots.

Parameter	Min	Max	Unit
Supply Voltage	0	14	V
Input Voltage Range	$-V_S - 0.5V$	$+V_S + 0.5V$	V

## Reliability Information

Parameter	Min	Typ	Max	Unit
Junction Temperature			150	°C
Storage Temperature Range	-65		150	°C
Lead Temperature (Soldering, 10s)			260	°C
Package Thermal Resistance				
6-Lead SOT23		177		°C/W
8-Lead SOIC		100		°C/W

Notes:

Package thermal resistance ( $\theta_{JA}$ ), JEDEC standard, multi-layer test boards, still air.

## ESD Protection

Product	SOT23-6
Human Body Model (HBM)	2kV
Charged Device Model (CDM)	2kV

## Recommended Operating Conditions

Parameter	Min	Typ	Max	Unit
Operating Temperature Range (CLC1002I)	-40		+85	°C
Operating Temperature Range (CLC1002A)	-40		+125	°C
Supply Voltage Range	4		12	V



## Electrical Characteristics at +5V

$T_A = 25^\circ\text{C}$ ,  $V_S = +5\text{V}$ ,  $-V_S = \text{GND}$ ,  $R_f = 100\Omega$ ,  $R_L = 500\Omega$  to  $V_S/2$ ,  $G = 5$ ; unless otherwise noted.

Symbol	Parameter	Conditions	Min	Typ	Max	Units
Frequency Domain Response						
GBWP	-3dB Gain Bandwidth Product	$G = +21$ , $V_{\text{OUT}} = 0.2V_{\text{pp}}$		910		MHz
$BW_{\text{SS}}$	-3dB Bandwidth	$G = +5$ , $V_{\text{OUT}} = 0.2V_{\text{pp}}$		265		MHz
$BW_{\text{LS}}$	Large Signal Bandwidth	$G = +5$ , $V_{\text{OUT}} = 2V_{\text{pp}}$		54		MHz
$BW_{0.1\text{dBSS}}$	0.1dB Gain Flatness Small Signal	$G = +5$ , $V_{\text{OUT}} = 0.2V_{\text{pp}}$		37		MHz
$BW_{0.1\text{dBLS}}$	0.1dB Gain Flatness Large Signal	$G = +5$ , $V_{\text{OUT}} = 2V_{\text{pp}}$		29		MHz
Time Domain Response						
$t_R, t_F$	Rise and Fall Time	$V_{\text{OUT}} = 1\text{V}$ step; (10% to 90%)		4.2		ns
$t_S$	Settling Time to 0.1%	$V_{\text{OUT}} = 1\text{V}$ step		12		ns
OS	Overshoot	$V_{\text{OUT}} = 1\text{V}$ step		3		%
SR	Slew Rate	4V step		160		V/ $\mu\text{s}$
Distortion/Noise Response						
HD2	2nd Harmonic Distortion	$1V_{\text{pp}}$ , 10MHz		-72		dBc
HD3	3rd Harmonic Distortion	$1V_{\text{pp}}$ , 10MHz		-74		dBc
THD	Total Harmonic Distortion	$1V_{\text{pp}}$ , 10MHz		-70		dB
$e_n$	Input Voltage Noise	> 100kHz		0.6		nV/ $\sqrt{\text{Hz}}$
$i_n$	Input Current Noise	> 100kHz		4.2		pA/ $\sqrt{\text{Hz}}$
DC Performance						
$V_{\text{IO}}$	Input Offset Voltage			0.1		mV
$dV_{\text{IO}}$	Average Drift			2.7		$\mu\text{V}/^\circ\text{C}$
$I_b$	Input Bias Current			28		$\mu\text{A}$
$dI_b$	Average Drift			46		nA/ $^\circ\text{C}$
$I_o$	Input Offset Current			0.1		$\mu\text{A}$
PSRR	Power Supply Rejection Ratio	DC		83		dB
$A_{\text{OL}}$	Open-Loop Gain	$V_{\text{OUT}} = V_S / 2$		80		dB
$I_S$	Supply Current	per channel		12.5		mA
Disable Characteristics						
$t_{\text{ON}}$	Turn On Time	1V step, 1% settling		80		ns
$t_{\text{OFF}}$	Turn Off Time			220		ns
$\text{OFF}_{\text{ISO}}$	Off Isolation	$2V_{\text{pp}}$ , 5MHz		73		dB
$\text{OFFC}_{\text{OUT}}$	Off Output Capacitance			5.8		pF
$V_{\text{OFF}}$	Power Down Voltage	Disabled if $\overline{\text{DIS}}$ pin is grounded or pulled below $V_{\text{OFF}}$		Disabled if $\overline{\text{DIS}} < 1.5$		V
$V_{\text{ON}}$	Enable Voltage	Enabled if $\overline{\text{DIS}}$ pin is floating or pulled above $V_{\text{ON}}$		Enabled if $\overline{\text{DIS}} > 3$		V
$I_{\text{SD}}$	Disable Supply Current	No Load, $\overline{\text{DIS}}$ pin tied to ground		130		$\mu\text{A}$
Input Characteristics						
$R_{\text{IN}}$	Input Resistance	Non-inverting		4.2		M $\Omega$
$C_{\text{IN}}$	Input Capacitance			2		pF
CMIR	Common Mode Input Range			0.8 to 5.1		V
CMRR	Common Mode Rejection Ratio	DC, $V_{\text{cm}} = 1.5\text{V}$ to 4V		94		dB
Output Characteristics						
$V_{\text{OUT}}$	Output Voltage Swing	$R_L = 500\Omega$		0.97 to 4		V
		$R_L = 2\text{k}\Omega$		0.96 to 4.1		V
$I_{\text{OUT}}$	Output Current			$\pm 125$		mA
$I_{\text{SC}}$	Short-Circuit Output Current	$V_{\text{OUT}} = V_S / 2$		$\pm 150$		mA

### Notes:

1. 100% tested at 25°C



## Electrical Characteristics at $\pm 5V$

$T_A = 25^\circ C$ ,  $V_S = \pm 5V$ ,  $R_f = 100\Omega$ ,  $R_L = 500\Omega$ ,  $G = 5$ ; unless otherwise noted.

Symbol	Parameter	Conditions	Min	Typ	Max	Units
Frequency Domain Response						
GBWP	-3dB Gain Bandwidth Product	$G = +21$ , $V_{OUT} = 0.2V_{pp}$		965		MHz
$BW_{SS}$	-3dB Bandwidth	$G = +5$ , $V_{OUT} = 0.2V_{pp}$		290		MHz
$BW_{LS}$	Large Signal Bandwidth	$G = +5$ , $V_{OUT} = 2V_{pp}$		61		MHz
$BW_{0.1dBSS}$	0.1dB Gain Flatness Small Signal	$G = +5$ , $V_{OUT} = 0.2V_{pp}$		45		MHz
$BW_{0.1dBLS}$	0.1dB Gain Flatness Large Signal	$G = +5$ , $V_{OUT} = 2V_{pp}$		32		MHz
Time Domain Response						
$t_R$ , $t_F$	Rise and Fall Time	$V_{OUT} = 1V$ step; (10% to 90%)		3.8		ns
$t_S$	Settling Time to 0.1%	$V_{OUT} = 1V$ step		12		ns
OS	Overshoot	$V_{OUT} = 1V$ step		2		%
SR	Slew Rate	2V step		170		V/ $\mu s$
Distortion/Noise Response						
HD2	2nd Harmonic Distortion	$2V_{pp}$ , 10MHz		-75		dBc
HD3	3rd Harmonic Distortion	$2V_{pp}$ , 10MHz		-66		dBc
THD	Total Harmonic Distortion	$2V_{pp}$ , 5MHz		-65.5		dB
$e_n$	Input Voltage Noise	> 100kHz		0.6		nV/ $\sqrt{Hz}$
$i_n$	Input Current Noise	> 100kHz		4.2		pA/ $\sqrt{Hz}$
DC Performance						
$V_{IO}$	Input Offset Voltage <sup>(1)</sup>		-1	0.5	1	mV
$dV_{IO}$	Average Drift			4.3		$\mu V/^\circ C$
$I_b$	Input Bias Current <sup>(1)</sup>		-60	30	60	$\mu A$
$dI_b$	Average Drift			44		nA/ $^\circ C$
$I_o$	Input Offset Current			0.3	6	$\mu A$
PSRR	Power Supply Rejection Ratio <sup>(1)</sup>	DC	78	83		dB
$A_{OL}$	Open-Loop Gain <sup>(1)</sup>	$V_{OUT} = V_S / 2$	70	83		dB
$I_S$	Supply Current <sup>(1)</sup>	per channel		13	16	mA
Disable Characteristics						
$t_{ON}$	Turn On Time	1V step, 1% settling		115		ns
$t_{OFF}$	Turn Off Time			210		ns
$OFF_{ISO}$	Off Isolation	$2V_{pp}$ , 5MHz		73		dB
$OFFC_{OUT}$	Off Output Capacitance			5.7		pF
$V_{OFF}$	Power Down Voltage	Disabled if $\overline{DIS}$ pin is grounded or pulled below $V_{OFF}$		Disabled if $\overline{DIS} < 1.3$		V
$V_{ON}$	Enable Voltage	Enabled if $\overline{DIS}$ pin is floating or pulled above $V_{ON}$		Enabled if $\overline{DIS} > 3$		V
$I_{SD}$	Disable Supply Current <sup>(1)</sup>	No Load, $\overline{DIS}$ pin tied to ground		180	225	$\mu A$
Input Characteristics						
$R_{IN}$	Input Resistance	Non-inverting		9.4		M $\Omega$
$C_{IN}$	Input Capacitance			1.82		pF
CMIR	Common Mode Input Range			-4.3 to 5		V
CMRR	Common Mode Rejection Ratio <sup>(1)</sup>	DC, $V_{cm} = -3.5V$ to $4V$	75	90		dB
Output Characteristics						
$V_{OUT}$	Output Voltage Swing	$R_L = 500\Omega$ <sup>(1)</sup>	-3.3	$\pm 4$	3.6	V
		$R_L = 2k\Omega$		$\pm 4$		V
$I_{OUT}$	Output Current			$\pm 130$		mA
$I_{SC}$	Short-Circuit Output Current	$V_{OUT} = V_S / 2$		$\pm 165$		mA

### Notes:

1. 100% tested at  $25^\circ C$



## Typical Performance Characteristics

$T_A = 25^\circ\text{C}$ ,  $V_S = \pm 5\text{V}$ ,  $R_f = 100\Omega$ ,  $R_L = 500\Omega$ ,  $G = 5$ ; unless otherwise noted.

Non-Inverting Frequency Response

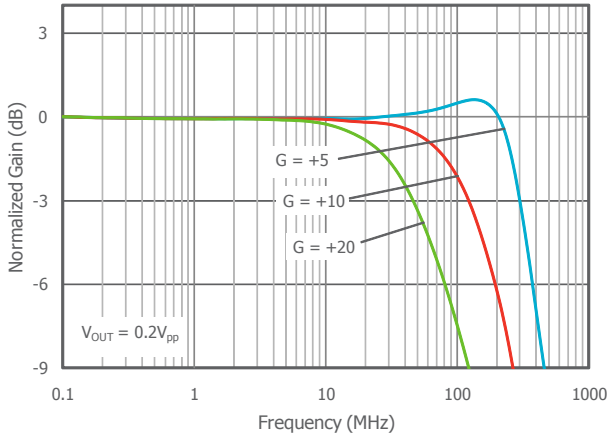

Inverting Frequency Response

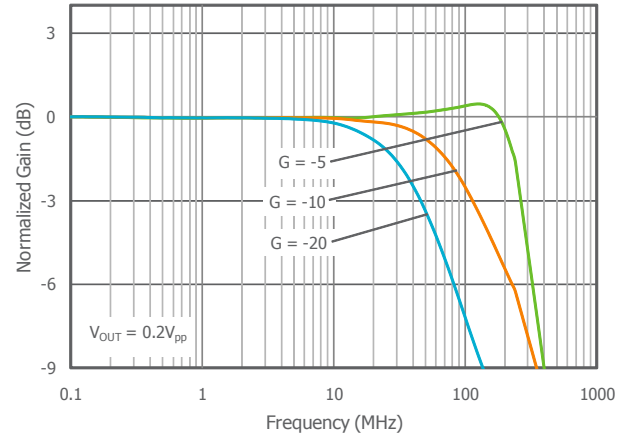

Frequency Response vs.  $C_L$

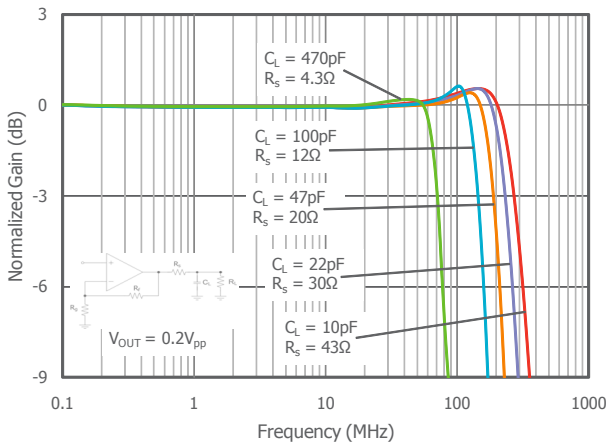

Frequency Response vs.  $R_L$

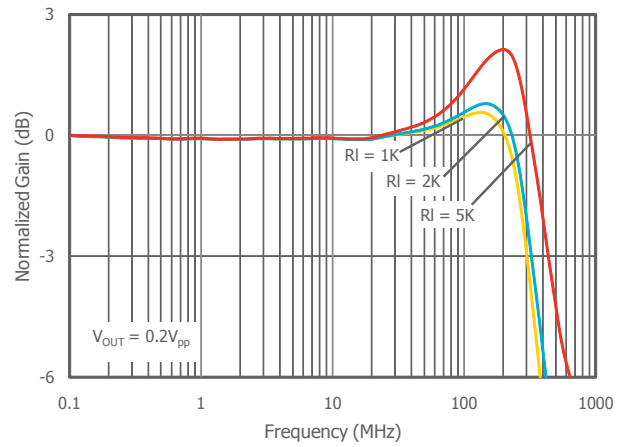

Frequency Response vs.  $V_{OUT}$

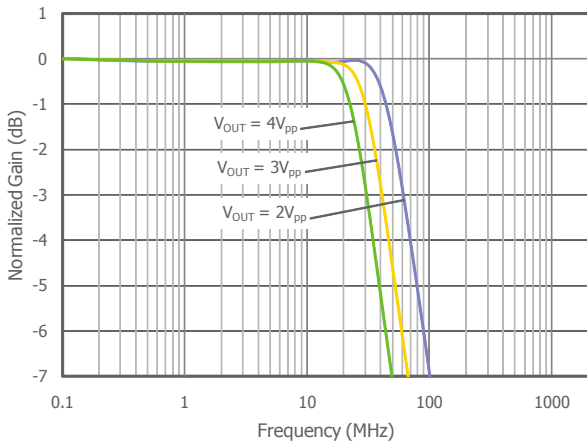

-3dB Bandwidth vs. Output Voltage

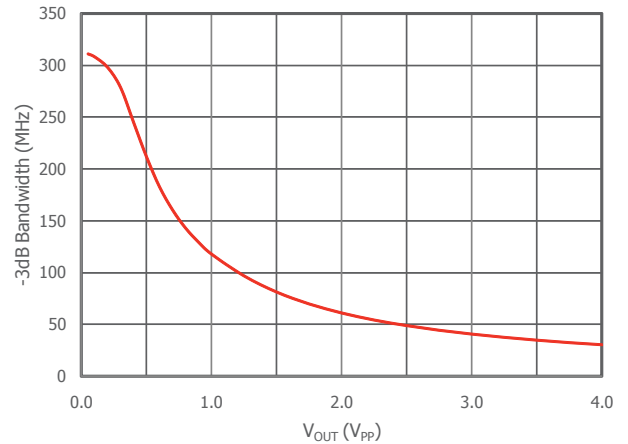



## Typical Performance Characteristics

$T_A = 25^\circ\text{C}$ ,  $V_S = \pm 5\text{V}$ ,  $R_f = 100\Omega$ ,  $R_L = 500\Omega$ ,  $G = 5$ ; unless otherwise noted.

Non-Inverting Frequency Response at  $V_S = 5\text{V}$

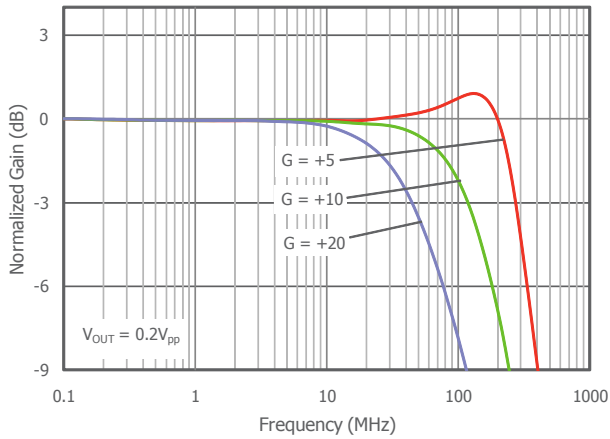

Inverting Frequency Response at  $V_S = 5\text{V}$

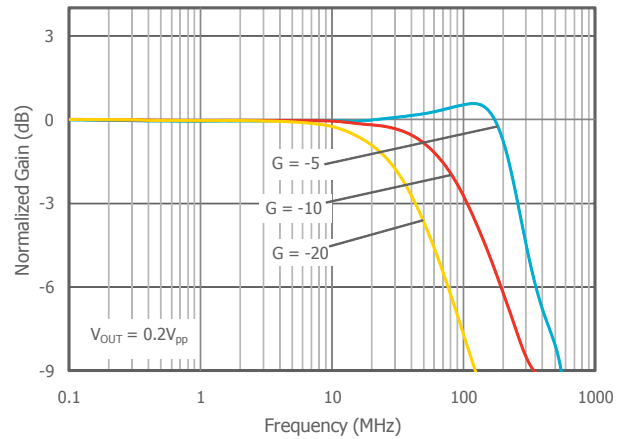

Frequency Response vs.  $C_L$  at  $V_S = 5\text{V}$

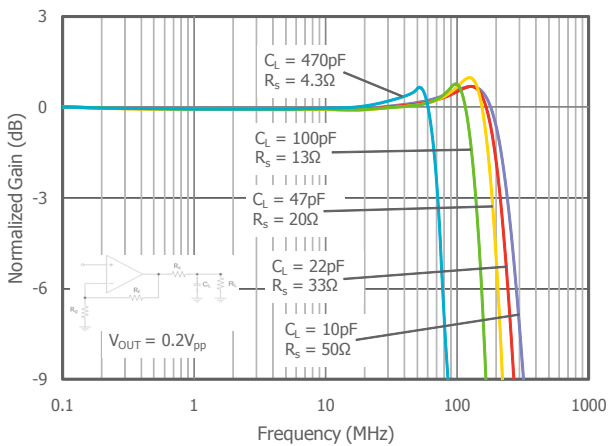

Frequency Response vs.  $R_L$  at  $V_S = 5\text{V}$

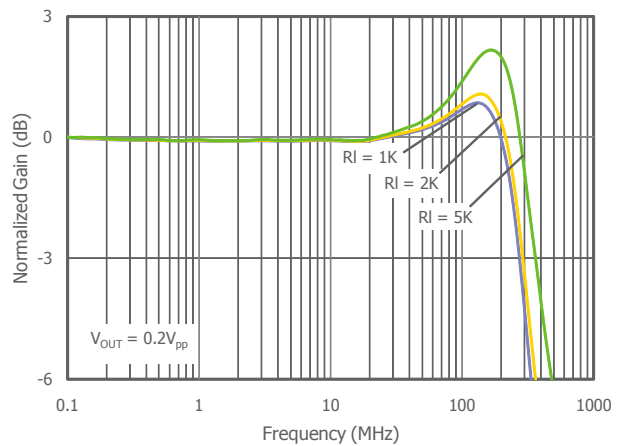

Frequency Response vs.  $V_{OUT}$  at  $V_S = 5\text{V}$

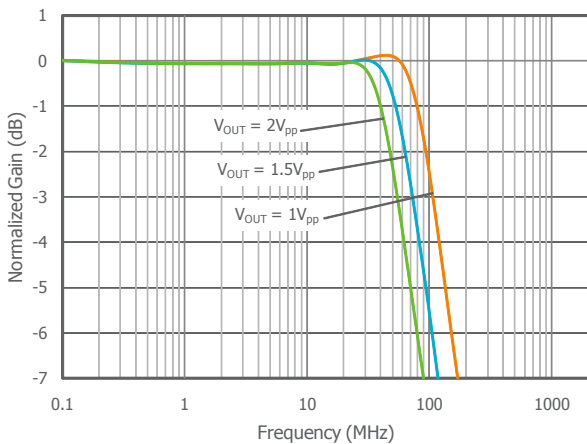

-3dB Bandwidth vs. Output Voltage at  $V_S = 5\text{V}$

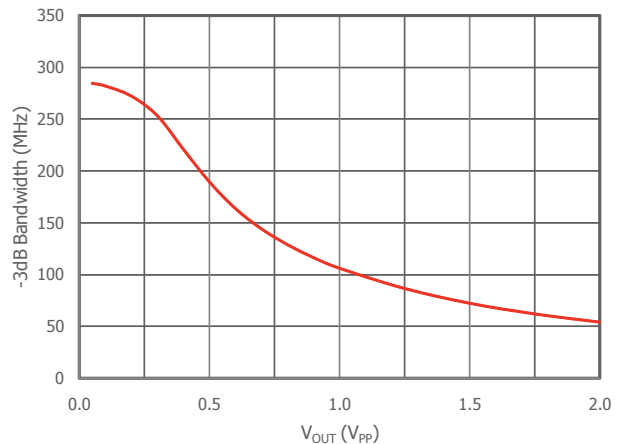



## Typical Performance Characteristics - Continued

$T_A = 25^\circ\text{C}$ ,  $V_S = \pm 5\text{V}$ ,  $R_f = 100\Omega$ ,  $R_L = 500\Omega$ ,  $G = 5$ ; unless otherwise noted.

### Input Voltage Noise

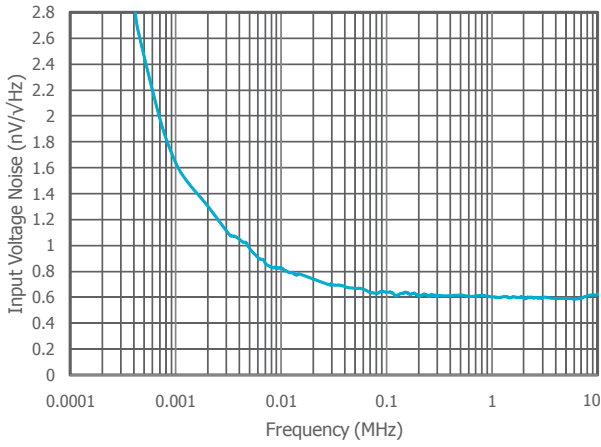

### Input Voltage Noise at $V_S = 5\text{V}$

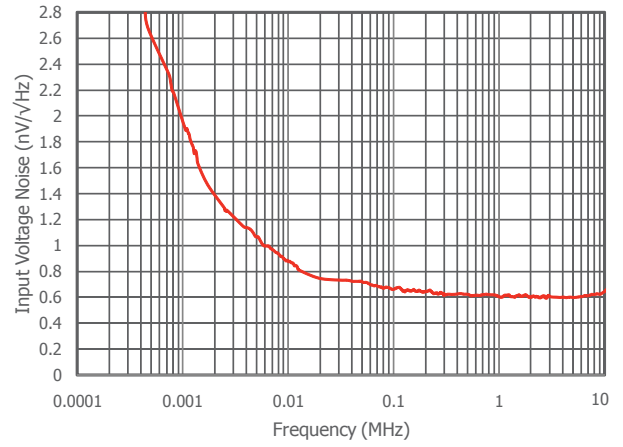

### Input Voltage Noise (>10kHz)

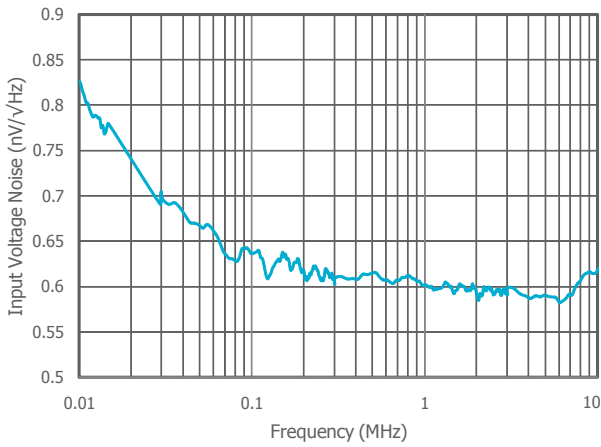

### Input Voltage Noise at $V_S = 5\text{V}$ (>10kHz)

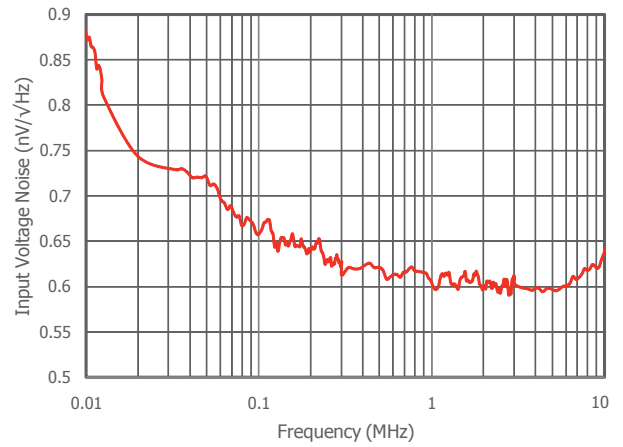

### $R_{OUT}$ vs. Frequency

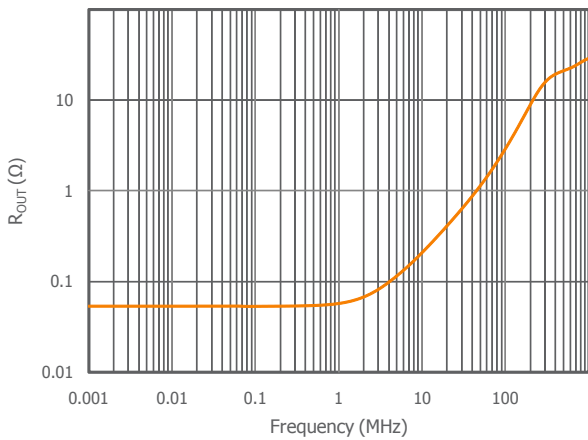



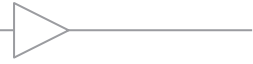

## Typical Performance Characteristics - Continued

$T_A = 25^\circ\text{C}$ ,  $V_S = \pm 5\text{V}$ ,  $R_f = 100\Omega$ ,  $R_L = 500\Omega$ ,  $G = 5$ ; unless otherwise noted.

2nd Harmonic Distortion vs.  $R_L$

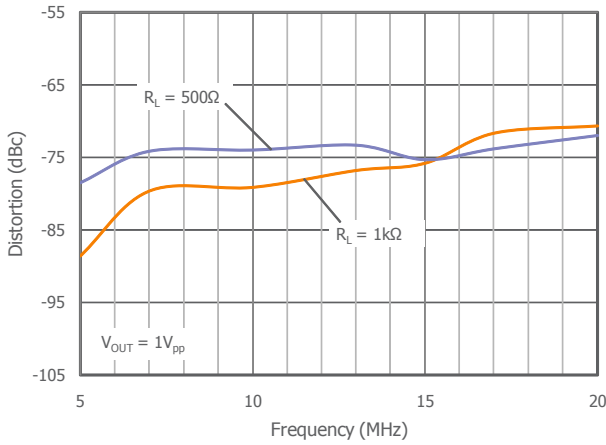

3rd Harmonic Distortion vs.  $R_L$

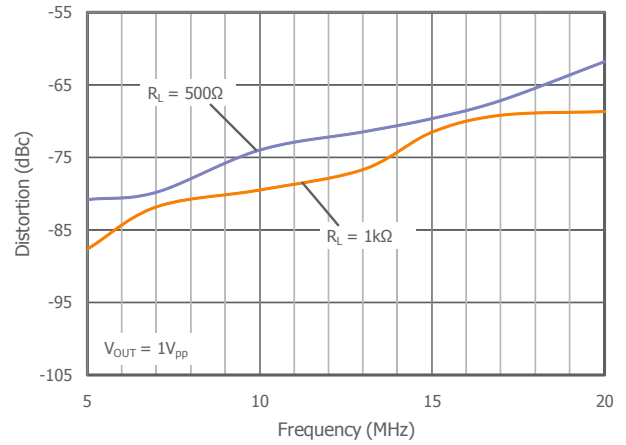

2nd Harmonic Distortion vs.  $V_{OUT}$

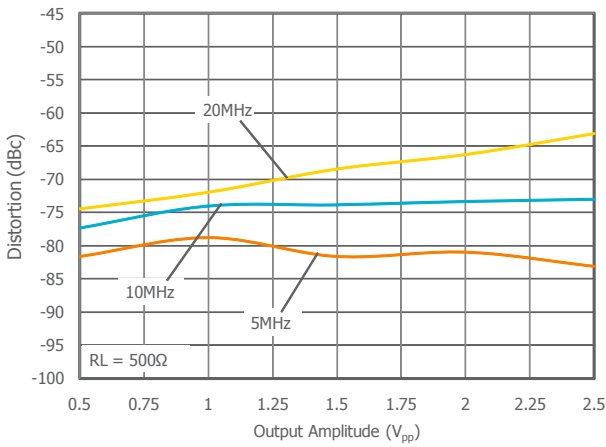

3rd Harmonic Distortion vs.  $V_{OUT}$

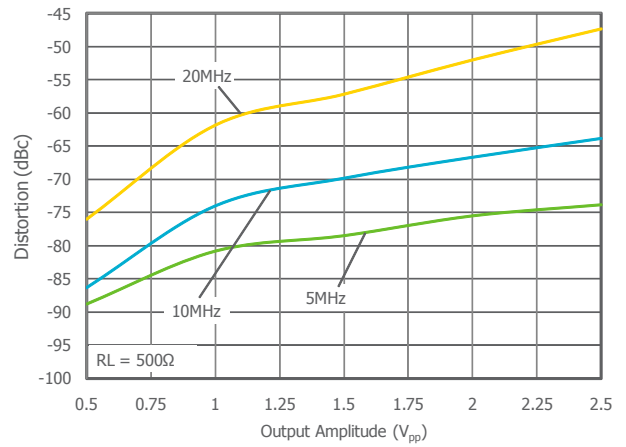

2nd Harmonic Distortion vs. Gain

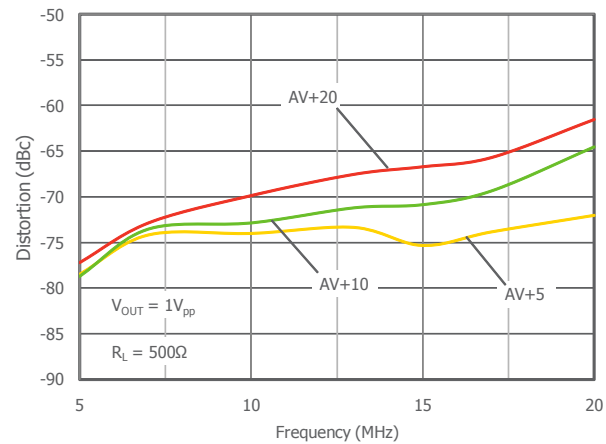

3rd Harmonic Distortion vs. Gain

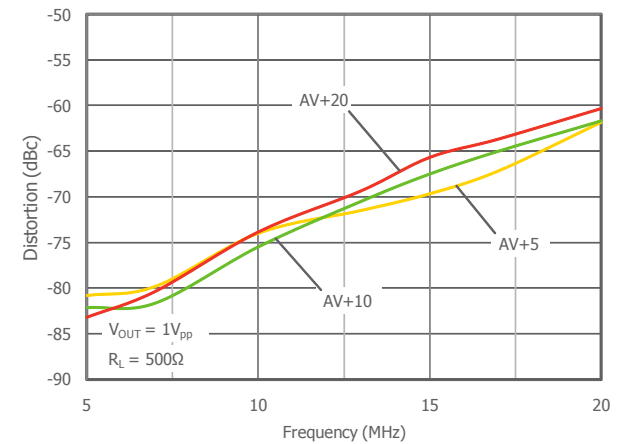



## Typical Performance Characteristics - Continued

$T_A = 25^\circ\text{C}$ ,  $V_S = \pm 5\text{V}$ ,  $R_f = 100\Omega$ ,  $R_L = 500\Omega$ ,  $G = 5$ ; unless otherwise noted.

2nd Harmonic Distortion vs.  $R_L$  at  $V_S = 5\text{V}$

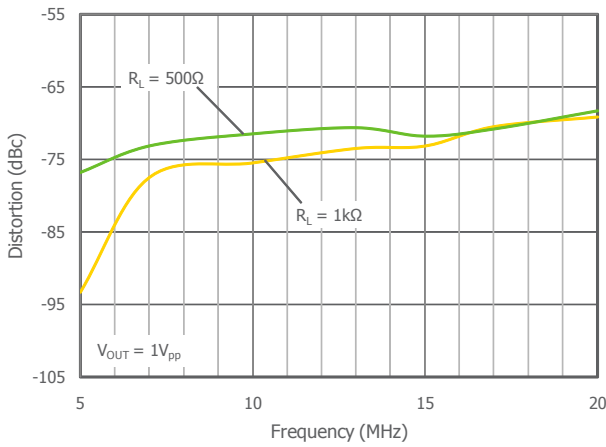

3rd Harmonic Distortion vs.  $R_L$  at  $V_S = 5\text{V}$

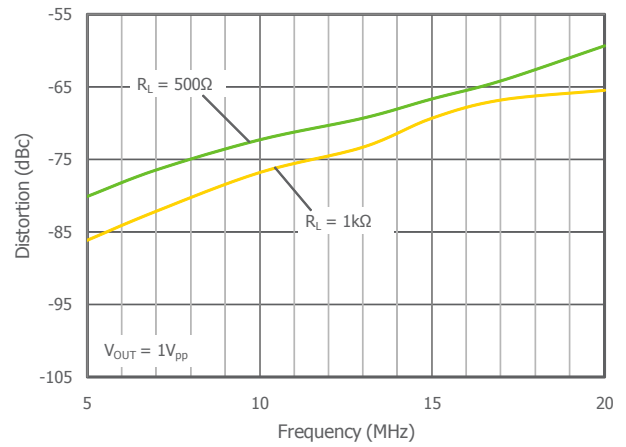

2nd Harmonic Distortion vs.  $V_{OUT}$  at  $V_S = 5\text{V}$

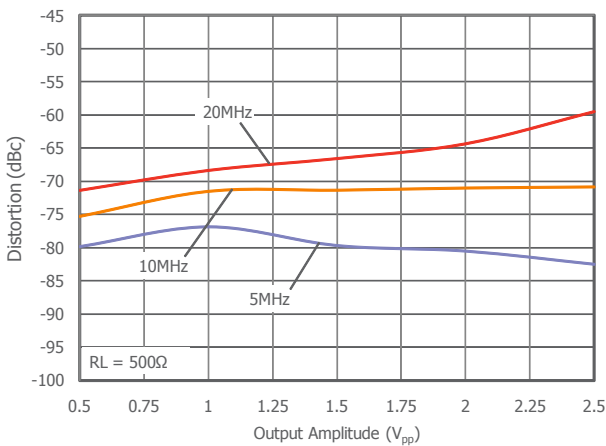

3rd Harmonic Distortion vs.  $V_{OUT}$  at  $V_S = 5\text{V}$

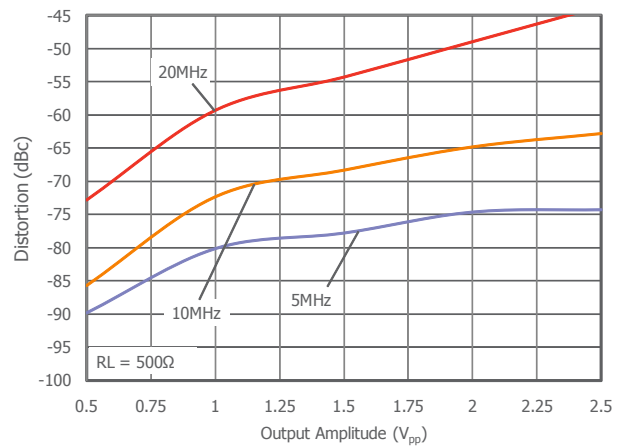

2nd Harmonic Distortion vs. Gain at  $V_S = 5\text{V}$

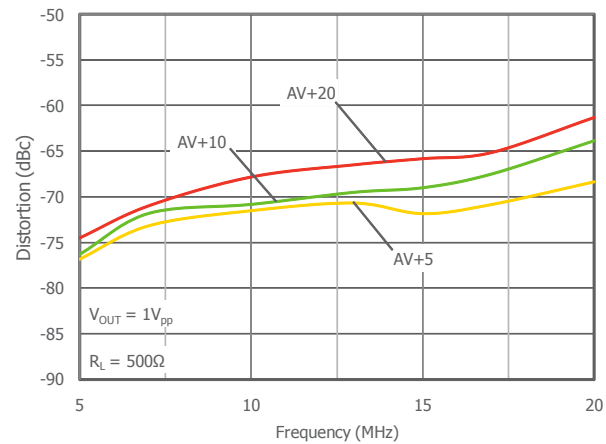

3rd Harmonic Distortion vs. Gain Freq at  $V_S = 5\text{V}$

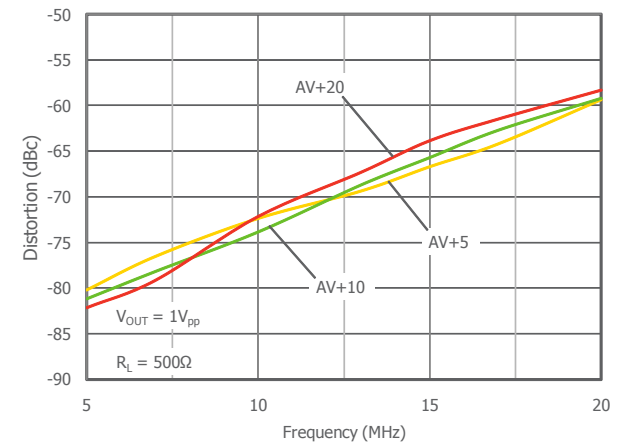



## Typical Performance Characteristics - Continued

$T_A = 25^\circ\text{C}$ ,  $V_S = \pm 5\text{V}$ ,  $R_f = 100\Omega$ ,  $R_L = 500\Omega$ ,  $G = 5$ ; unless otherwise noted.

Small Signal Pulse Response

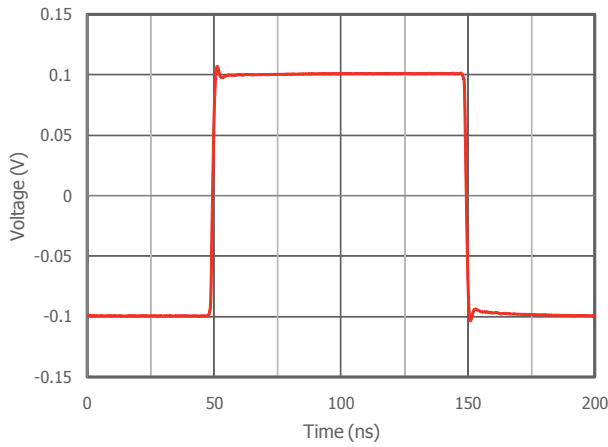

Small Signal Pulse Response at  $V_S = 5\text{V}$

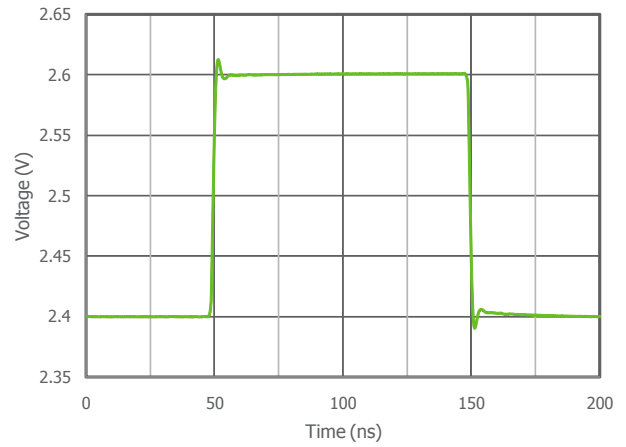

Large Signal Pulse Response

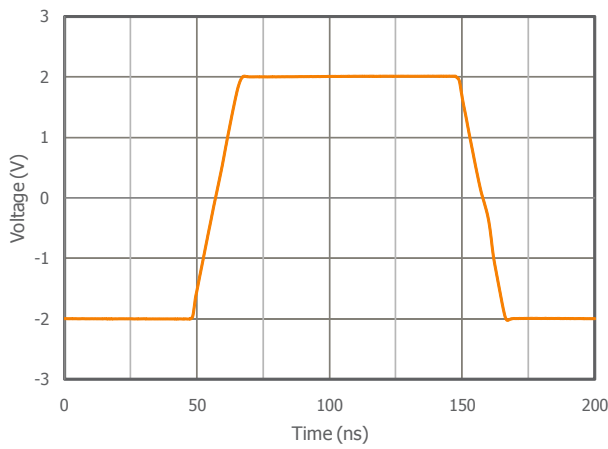

Large Signal Pulse Response at  $V_S = 5\text{V}$

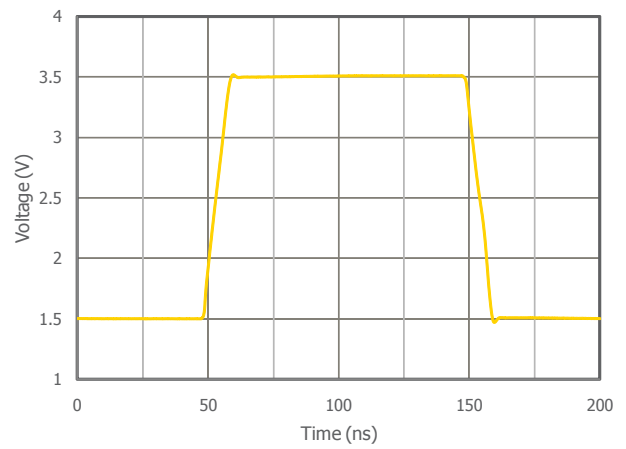

Enable Response

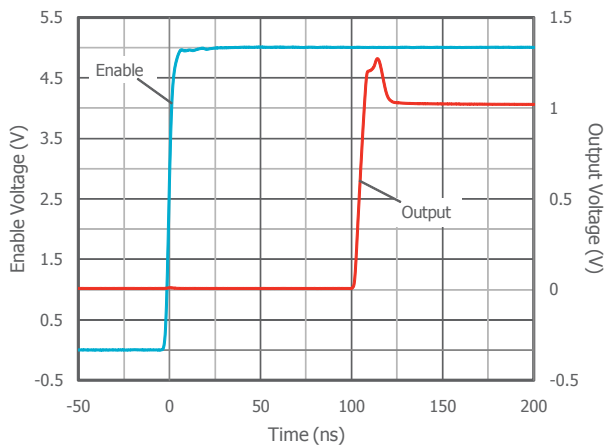

Disable Response

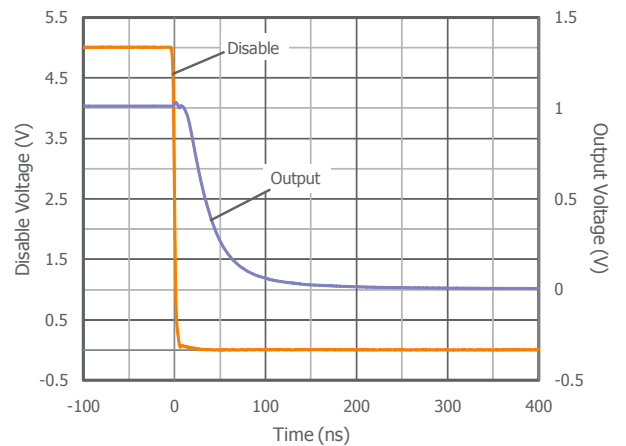



## Typical Performance Characteristics - Continued

$T_A = 25^\circ\text{C}$ ,  $V_S = \pm 5\text{V}$ ,  $R_f = 100\Omega$ ,  $R_L = 500\Omega$ ,  $G = 5$ ; unless otherwise noted.

Enable Response at  $V_S = 5\text{V}$

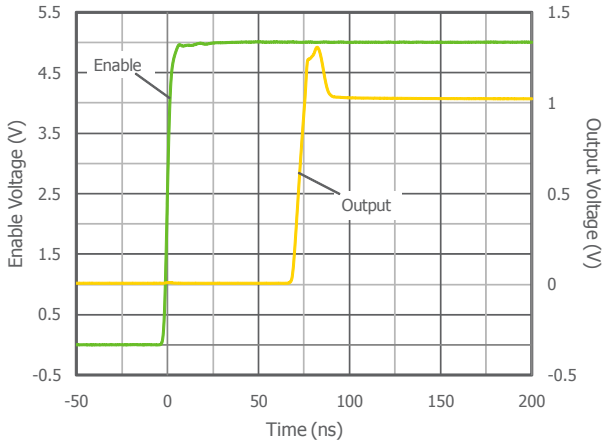

Disable Response at  $V_S = 5\text{V}$

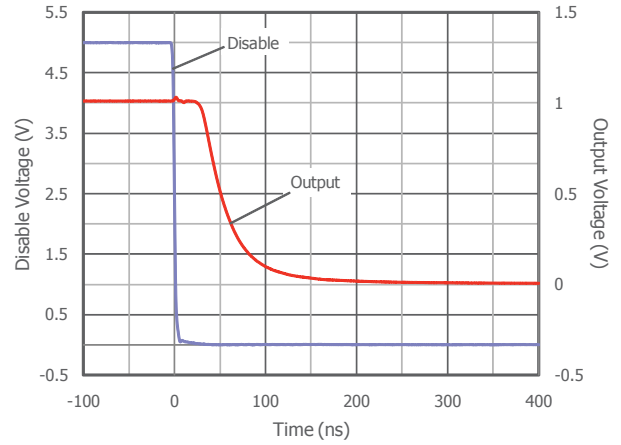

Off Isolation

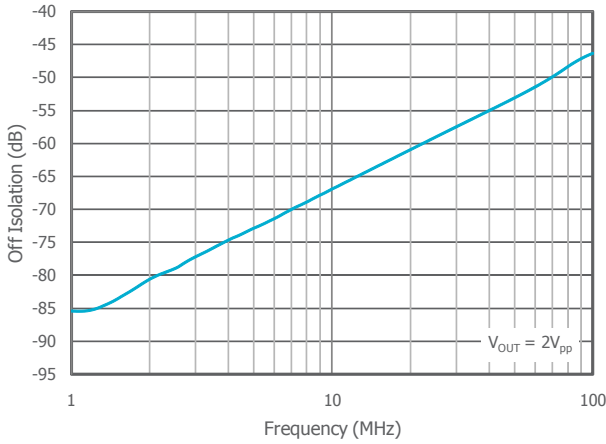

Off Isolation at  $V_S = 5\text{V}$

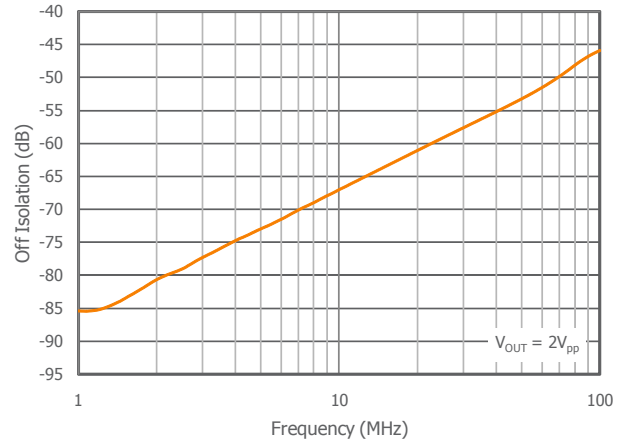

CMRR vs. Frequency

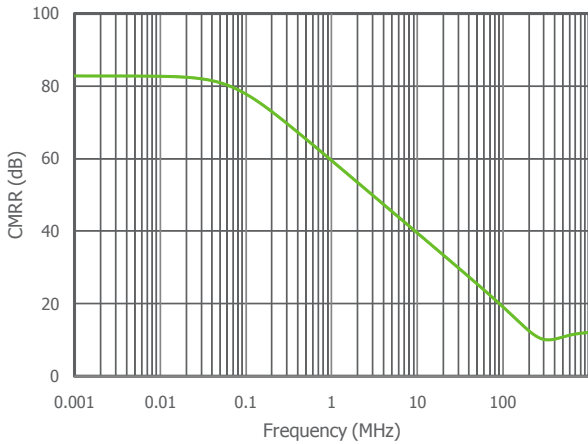

PSRR vs. Frequency

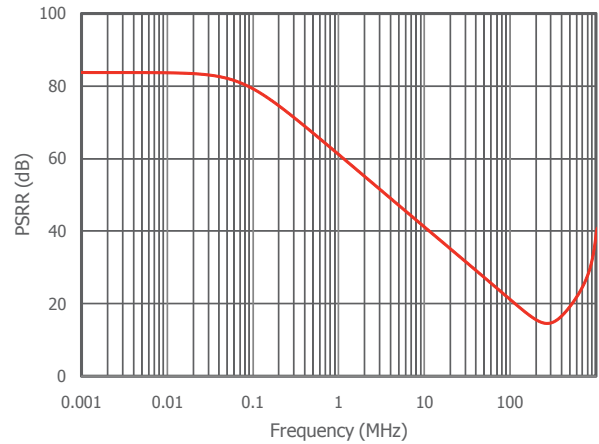



## Application Information

### Basic Operation

Figures 1 and 2 illustrate typical circuit configurations for non-inverting, inverting, and unity gain topologies for dual supply applications. They show the recommended bypass capacitor values and overall closed loop gain equations.

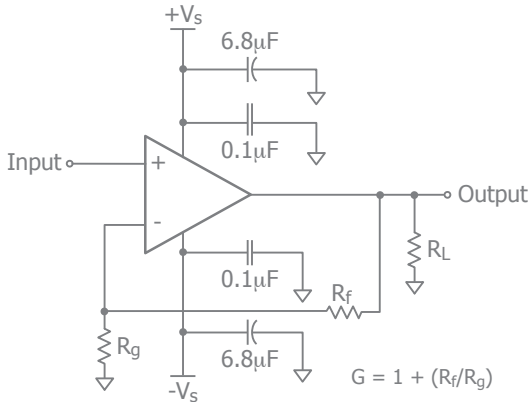

Figure 1. Typical Non-Inverting Gain Circuit

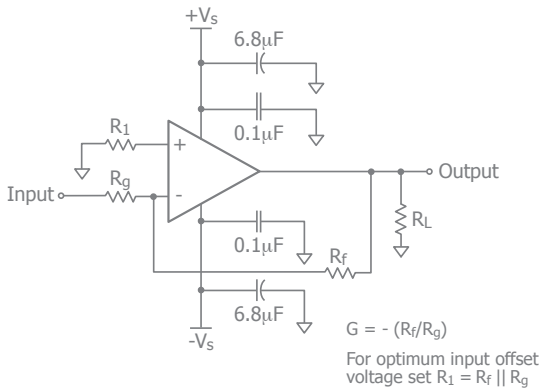

Figure 2. Typical Inverting Gain Circuit

### Achieving Low Noise in an Application

Making full use of the low noise of the CLC1002 requires careful consideration of resistor values. The feedback and gain set resistors ( $R_f$  and  $R_g$ ) and the non-inverting source impedance ( $R_{source}$ ) all contribute noise to the circuit and can easily dominate the overall noise if their values are too high. The datasheet is specified with an  $R_g$  of  $25\Omega$ , at which point the noise from  $R_f$  and  $R_g$  is about equal to the noise from the CLC1002. Lower value resistors could be used at the expense of more distortion.

Figure 3 shows total input voltage noise (amp+resistors)

versus  $R_f$  and  $R_g$ . As the value of  $R_f$  increases, the total input referred noise also increases.

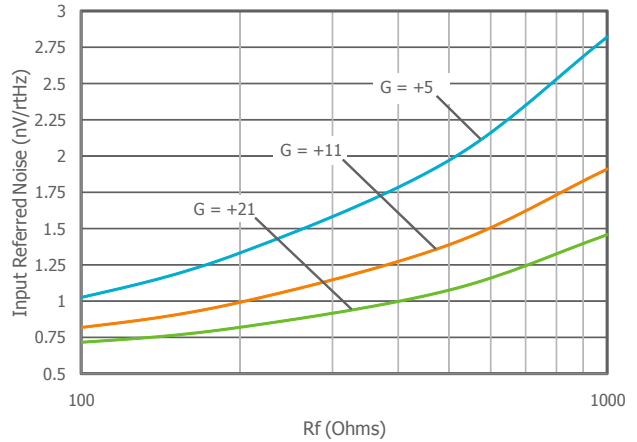

Figure 3: Input Referred Voltage Noise vs.  $R_f$  and  $R_g$

The noise caused by a resistor is modeled with either a voltage source in series with the resistance:

$$\sqrt{4kTR}$$

Or a current source in parallel with it:

$$i_R = \sqrt{\frac{4kT}{R}}$$

Op amp noise is modeled with three noise sources,  $e_n$ ,  $i_n$  and  $i_p$ . These three sources are analogous to the DC input voltage and current errors  $V_{os}$ ,  $I_{bn}$  and  $I_{bi}$ .

The noise models must be analyzed in-circuit to determine the effect on the op amp output noise.

Since noise is statistical in nature rather than a continuous signal, the set of noise sources in circuit add in an RMS (root mean square) fashion rather than in a linear fashion. For uncorrelated noise sources, this means you add the squares of the noise voltages. A typical non-inverting application (see figure 1) results in the following noise at the output of the op amp:



$$e_o^2 = e_n^2 \left( 1 + \frac{R_f}{R_g} \right)^2 + i_n^2 R_s^2 \left( 1 + \frac{R_f}{R_g} \right)^2 + i_i^2 R_f^2$$

op amp noise terms  $e_n$ ,  $i_n$  and  $i_i$

$$+ e_{R_s}^2 \left( 1 + \frac{R_f}{R_g} \right)^2 + e_{R_g}^2 \left( \frac{R_f}{R_g} \right)^2 + e_{R_f}^2$$

external resistor noise terms for  $R_s$ ,  $R_g$  and  $R_f$

High source impedances are sometimes unavoidable, but they increase noise from the source impedance and also make the circuit more sensitive to the op amp current noise. Analyze all noise sources in the circuit, not just the op amp itself, to achieve low noise in your application.

### Power Dissipation

Power dissipation should not be a factor when operating under the stated 500Ω load condition. However, applications with low impedance, DC coupled loads should be analyzed to ensure that maximum allowed junction temperature is not exceeded. Guidelines listed below can be used to verify that the particular application will not cause the device to operate beyond its intended operating range.

Maximum power levels are set by the absolute maximum junction rating of 150°C. To calculate the junction temperature, the package thermal resistance value  $\Theta_{JA}$  ( $\Theta_{JA}$ ) is used along with the total die power dissipation.

$$T_{Junction} = T_{Ambient} + (\Theta_{JA} \times P_D)$$

Where  $T_{Ambient}$  is the temperature of the working environment.

In order to determine  $P_D$ , the power dissipated in the load needs to be subtracted from the total power delivered by the supplies.

$$P_D = P_{supply} - P_{load}$$

Supply power is calculated by the standard power equation.

$$P_{supply} = V_{supply} \times I_{RMS\ supply}$$

$$V_{supply} = V_{S+} - V_{S-}$$

Power delivered to a purely resistive load is:

$$P_{load} = ((V_{LOAD})_{RMS})^2 / R_{load\ eff}$$

The effective load resistor ( $R_{load\ eff}$ ) will need to include the effect of the feedback network. For instance,

$R_{load\ eff}$  in figure 3 would be calculated as:

$$R_L \parallel (R_f + R_g)$$

These measurements are basic and are relatively easy to perform with standard lab equipment. For design purposes however, prior knowledge of actual signal levels and load impedance is needed to determine the dissipated power. Here,  $P_D$  can be found from

$$P_D = P_{Quiescent} + P_{Dynamic} - P_{Load}$$

Quiescent power can be derived from the specified  $I_S$  values along with known supply voltage,  $V_{Supply}$ . Load power can be calculated as above with the desired signal amplitudes using:

$$(V_{LOAD})_{RMS} = V_{PEAK} / \sqrt{2}$$

$$(I_{LOAD})_{RMS} = (V_{LOAD})_{RMS} / R_{load\ eff}$$

The dynamic power is focused primarily within the output stage driving the load. This value can be calculated as:

$$P_{DYNAMIC} = (V_{S+} - V_{LOAD})_{RMS} \times (I_{LOAD})_{RMS}$$

Assuming the load is referenced in the middle of the power rails or  $V_{supply}/2$ .

Figure 4 shows the maximum safe power dissipation in the package vs. the ambient temperature for the packages available.

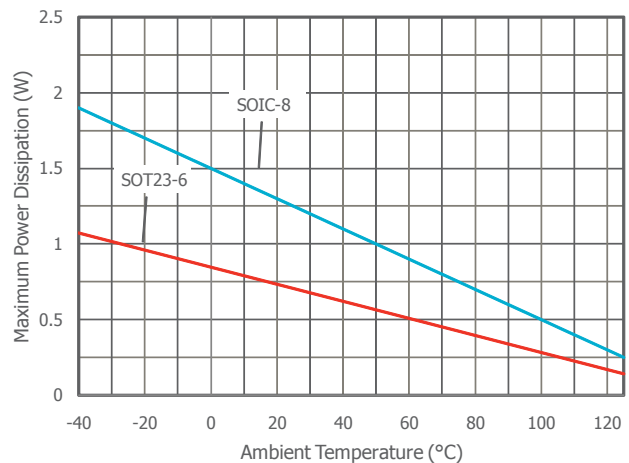

Figure 4. Maximum Power Derating



### Driving Capacitive Loads

Increased phase delay at the output due to capacitive loading can cause ringing, peaking in the frequency response, and possible unstable behavior. Use a series resistance,  $R_S$ , between the amplifier and the load to help improve stability and settling performance. Refer to Figure 5.

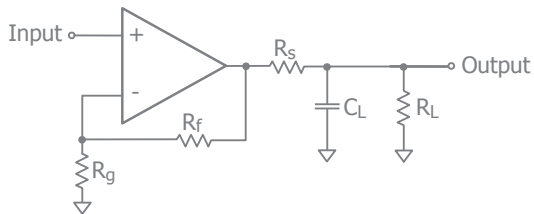

Figure 5. Addition of  $R_S$  for Driving Capacitive Loads

Table 1 provides the recommended  $R_S$  for various capacitive loads. The recommended  $R_S$  values result in  $\leq 1$ dB peaking in the frequency response. The Frequency Response vs.  $C_L$  plots, on page 7, illustrates the response of the CLC1002.

$C_L$ (pF)	$R_S$ ( $\Omega$ )	-3dB BW (MHz)
10	43	275
22	30	235
47	20	190
100	12	146
470	4.3	72

Table 1: Recommended  $R_S$  vs.  $C_L$

For a given load capacitance, adjust  $R_S$  to optimize the tradeoff between settling time and bandwidth. In general, reducing  $R_S$  will increase bandwidth at the expense of additional overshoot and ringing.

### Overdrive Recovery

An overdrive condition is defined as the point when either one of the inputs or the output exceed their specified voltage range. Overdrive recovery is the time needed for the amplifier to return to its normal or linear operating point. The recovery time varies, based on whether the input or output is overdriven and by how much the range is exceeded. The CLC1002 will typically recover in less than 25ns from an overdrive condition. Figure 6 shows the CLC1002 in an overdriven condition.

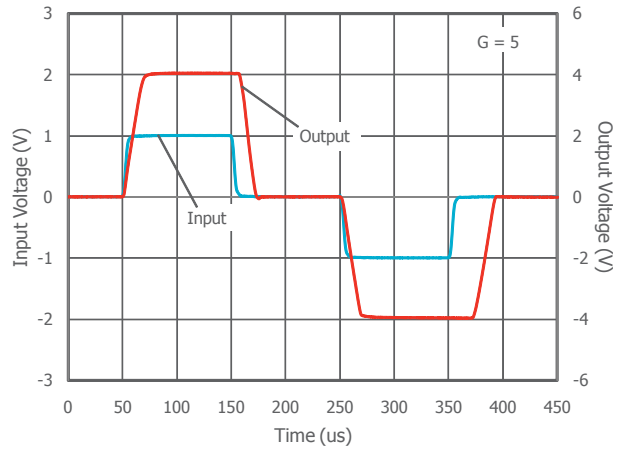

Figure 6. Overdrive Recovery

### Layout Considerations

General layout and supply bypassing play major roles in high frequency performance. CADEKA has evaluation boards to use as a guide for high frequency layout and as aid in device testing and characterization. Follow the steps below as a basis for high frequency layout:

- Include 6.8 $\mu$ F and 0.1 $\mu$ F ceramic capacitors for power supply decoupling
- Place the 6.8 $\mu$ F capacitor within 0.75 inches of the power pin
- Place the 0.1 $\mu$ F capacitor within 0.1 inches of the power pin
- Remove the ground plane under and around the part, especially near the input and output pins to reduce parasitic capacitance
- Minimize all trace lengths to reduce series inductances

Refer to the evaluation board layouts below for more information.

### Evaluation Board Information

The following evaluation boards are available to aid in the testing and layout of these devices:

Evaluation Board	Products
CEB002	CLC1002 in SOT23-5
CEB003	CLC1002 in SOIC-8



Evaluation Board Schematics

Evaluation board schematics and layouts are shown in Figures 7-11. These evaluation boards are built for dual-supply operation. Follow these steps to use the board in a single-supply application:

1. Short -Vs to ground.
2. Use C3 and C4, if the -Vs pin of the amplifier is not directly connected to the ground plane.

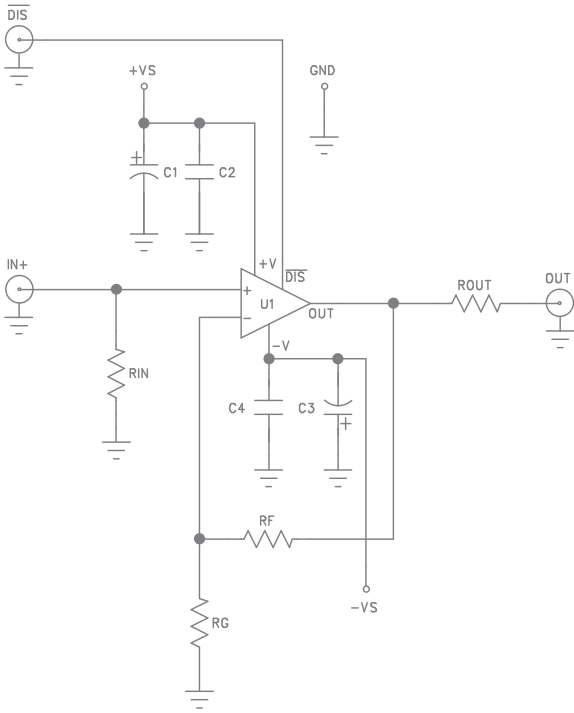

Figure 7. CEB002/CEB003 Schematic

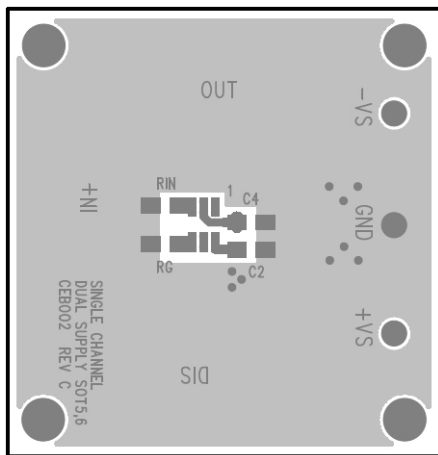

Figure 8. CEB002 Top View

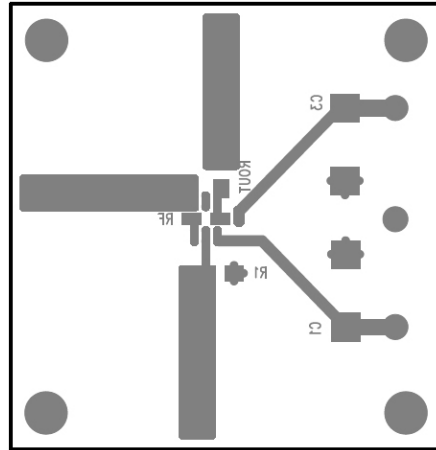

Figure 9. CEB002 Bottom View

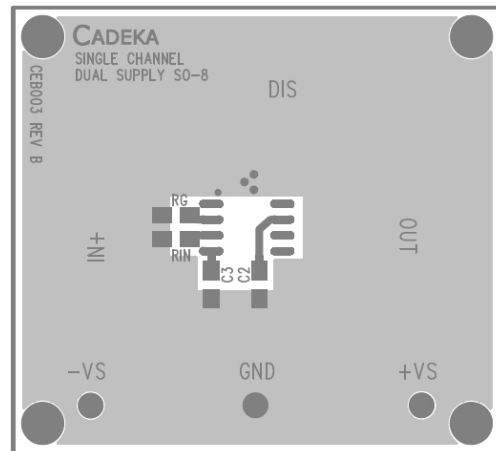

Figure 10. CEB003 Top View

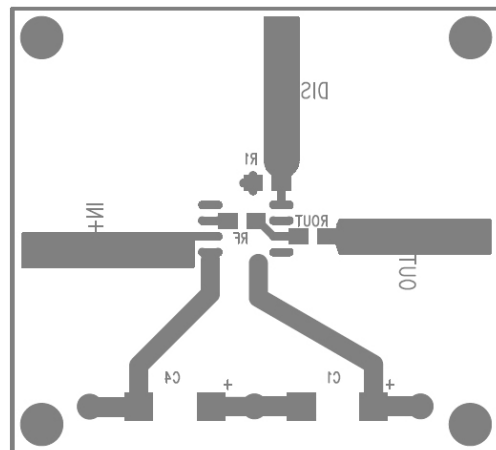

Figure 11. CEB003 Bottom View





## Mechanical Dimensions

### SOT23-6 Package

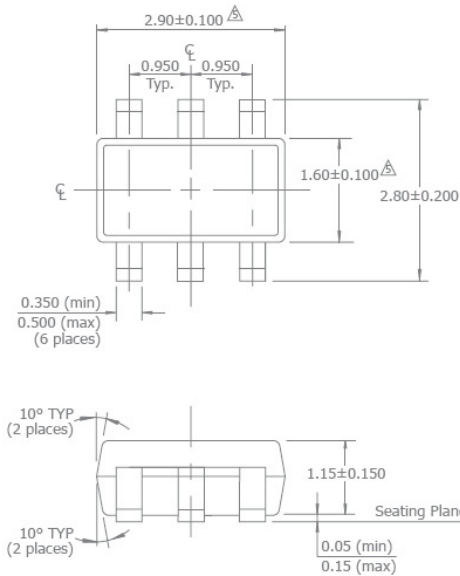

**NOTES:**

1. Dimensions and tolerances are as per ANSI Y14.5M-1982.
  2. Package surface to be matte finish VDI 11~13.
  3. Die is facing up for mold. Die is facing down for trim/form, ie. reverse trim/form.
  4. The footlength measuring is based on the gauge plane method.
- △ Dimension are exclusive of mold flash and gate burr.  
 △ Dimension are exclusive of solder plating.

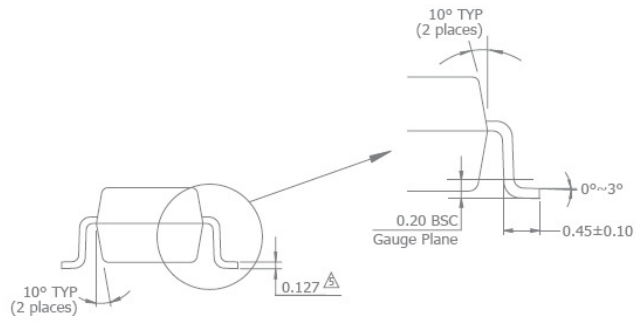

### SOIC-8 Package

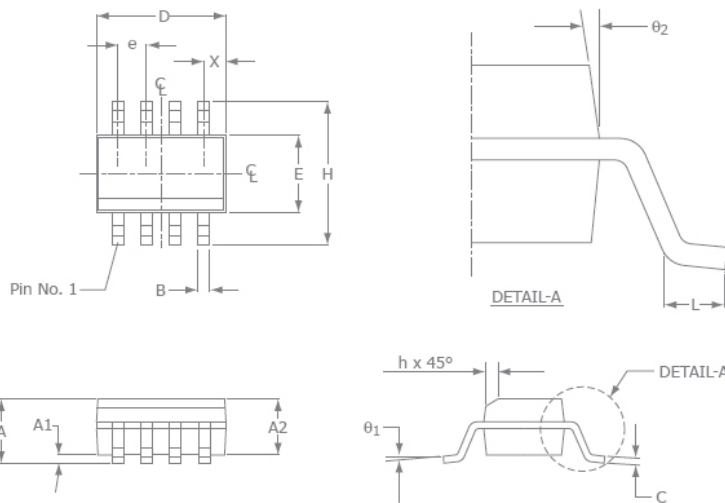

SOIC-8		
SYMBOL	MIN	MAX
A1	0.10	0.25
B	0.36	0.48
C	0.19	0.25
D	4.80	4.98
E	3.81	3.99
e	1.27 BSC	
H	5.80	6.20
h	0.25	0.5
L	0.41	1.27
A	1.37	1.73
θ <sub>1</sub>	0°	8°
X	0.55 ref	
θ <sub>2</sub>	7° BSC	

**NOTE:**

1. All dimensions are in millimeters.
2. Lead coplanarity should be 0 to 0.1mm (0.004") max.
3. Package surface finishing: VDI 24~27
4. All dimension excluding mold flashes.
5. The lead width, B to be determined at 0.1905mm from the lead tip.

For additional information regarding our products, please visit CADEKA at: [cadeka.com](http://cadeka.com)

**CADEKA Headquarters** Loveland, Colorado  
 T: 970.663.5452  
 T: 877.663.5452 (toll free)

CADEKA, the CADEKA logo design, COMLINEAR and the COMLINEAR logo design are trademarks or registered trademarks of CADEKA Microcircuits LLC. All other brand and product names may be trademarks of their respective companies.

CADEKA reserves the right to make changes to any products and services herein at any time without notice. CADEKA does not assume any responsibility or liability arising out of the application or use of any product or service described herein, except as expressly agreed to in writing by CADEKA; nor does the purchase, lease, or use of a product or service from CADEKA convey a license under any patent rights, copyrights, trademark rights, or any other of the intellectual property rights of CADEKA or of third parties.

Copyright ©2007-2008 by CADEKA Microcircuits LLC. All rights reserved.



## Данный компонент на территории Российской Федерации

### Вы можете приобрести в компании MosChip.

Для оперативного оформления запроса Вам необходимо перейти по данной ссылке:

<http://moschip.ru/get-element>

Вы можете разместить у нас заказ для любого Вашего проекта, будь то серийное производство или разработка единичного прибора.

В нашем ассортименте представлены ведущие мировые производители активных и пассивных электронных компонентов.

Нашей специализацией является поставка электронной компонентной базы двойного назначения, продукции таких производителей как XILINX, Intel (ex.ALTERA), Vicor, Microchip, Texas Instruments, Analog Devices, Mini-Circuits, Amphenol, Glenair.

Сотрудничество с глобальными дистрибьюторами электронных компонентов, предоставляет возможность заказывать и получать с международных складов практически любой перечень компонентов в оптимальные для Вас сроки.

На всех этапах разработки и производства наши партнеры могут получить квалифицированную поддержку опытных инженеров.

Система менеджмента качества компании отвечает требованиям в соответствии с ГОСТ Р ИСО 9001, ГОСТ РВ 0015-002 и ЭС РД 009

### Офис по работе с юридическими лицами:

105318, г.Москва, ул.Щербаковская д.3, офис 1107, 1118, ДЦ «Щербаковский»

Телефон: +7 495 668-12-70 (многоканальный)

Факс: +7 495 668-12-70 (доб.304)

E-mail: [info@moschip.ru](mailto:info@moschip.ru)

Skype отдела продаж:

moschip.ru

moschip.ru\_4

moschip.ru\_6

moschip.ru\_9