

High Speed Optocoupler, 10 Mbd

Features

- Choice of CMR performance of 10 kV/μs, 5 kV/μs, and 100 V/μs
- High speed: 10 Mbd typical
- + 5 V CMOS compatibility
- Guaranteed AC and DC performance over temperature: - 40 to + 100 °C Temp. Range
- Pure tin leads
- Meets IEC60068-2-42 (SO₂) and IEC60068-2-43 (H₂S) requirements
- Low input current capability: 5 mA
- Lead-free component
- Component in accordance to RoHS 2002/95/EC and WEEE 2002/96/EC

Agency Approvals

- UL1577, File No. E52744 System Code H or J, Double Protection
- CUL - File No. E52744, equivalent to CSA bulletin 5A
- DIN EN 60747-5-2 (VDE0884)
- Reinforced insulation rating per IEC60950 2.10.5.1
- VDE available with Option 1

Applications

Microprocessor System Interface
 PLC, ATE input/output isolation
 Computer peripheral interface
 Digital Fieldbus Isolation: CC-Link, DeviceNet, Profibus, SDS
 High speed A/D and D/A conversion
 AC Plasma Display Panel Level Shifting
 Multiplexed Data Transmission
 Digital control power supply
 Ground loop elimination

Description

The 6N137, SFH674x and SFH675x are single channel 10 Mbd optocouplers utilizing a high efficient input LED coupled with an integrated optical photodiode IC detector. The detector has an open drain NMOS-transistor output, providing less leakage compared to an open collector Schottky clamped transistor output.

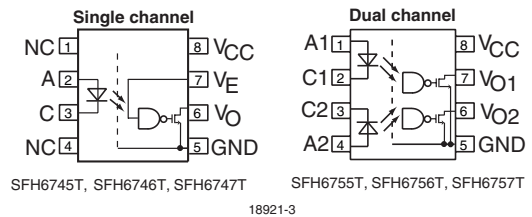

For the single channel type, an enable function on pin 7 allows the detector to be strobed. The internal shield provides a guaranteed common mode transient immunity of 5 kV/μs for the SFH6741 and SFH6751 and 10 kV/μs for the SFH6742 and SFH6752. The use of a 0.1 μF bypass capacitor connected between pin 5 and 8 is recommended.

Order Information

Part	Remarks
6N137	100 V/μs, Single channel, DIP-8
6N137-X006	100 V/μs, Single channel, DIP-8 400 mil (option 6)
6N137-X007	100 V/μs, Single channel, SMD-8 (option 7)
SFH6741	5 kV/μs, Single channel, DIP-8
SFH6741-X006	5 kV/μs, Single channel, DIP-8 400 mil (option 6)
SFH6741-X007	5 kV/μs, Single channel, SMD-8 (option 7)
SFH6742	10 kV/μs, Single channel, DIP-8
SFH6742-X006	10 kV/μs, Single channel, DIP-8 400 mil (option 6)
SFH6742-X007	10 kV/μs, Single channel, SMD-8 (option 7)
SFH6750	100 V/μs, Dual channel, DIP-8
SFH6750-X006	100 V/μs, Dual channel, DIP-8 400 mil (option 6)
SFH6750-X007	100 V/μs, Dual channel, SMD-8 (option 7)
SFH6751	5 kV/μs, Dual channel, DIP-8

Part	Remarks
SFH6751-X006	5 kV/μs, Dual channel, DIP-8 400 mil (option 6)
SFH6751-X007	5 kV/μs, Dual channel, SMD-8 (option 7)
SFH6752	10 kV/μs, Dual channel, DIP-8
SFH6752-X006	10 kV/μs, Dual channel, DIP-8 400 mil (option 6)
SFH6752-X007	10 kV/μs, Dual channel, SMD-8 (option 7)

Truth Table (Positive Logic)

LED	ENABLE	OUTPUT
ON	H	L
OFF	H	H
ON	L	H
OFF	L	H
ON	NC	L
OFF	NC	H

Absolute Maximum Ratings

$T_{amb} = 25\text{ }^{\circ}\text{C}$, unless otherwise specified

Stresses in excess of the absolute Maximum Ratings can cause permanent damage to the device. Functional operation of the device is not implied at these or any other conditions in excess of those given in the operational sections of this document. Exposure to absolute Maximum Rating for extended periods of the time can adversely affect reliability.

Input

Parameter	Test condition	Symbol	Value	Unit
Average forward current ¹⁾		I_F	20	mA
Average forward current ²⁾		I_F	15	mA
Reverse input voltage		V_R	5	V
Enable input voltage ¹⁾		V_E	$V_{CC} + 0.5\text{ V}$	V
Enable input current ¹⁾		I_E	5	mA
Surge current	$t = 100\text{ }\mu\text{s}$	I_{FSM}	200	mA

¹⁾ Package: Single DIP-8

²⁾ Package: Dual DIP-8

Output

Parameter	Test condition	Symbol	Value	Unit
Supply voltage	1 minute max.	V_{CC}	7	V
Output current		I_O	50	mA
Output voltage		V_O	7	V
Output power dissipation ¹⁾		P_{diss}	85	mW
Output power dissipation per channel ²⁾		P_{diss}	60	mW

¹⁾ Package: Single DIP-8

²⁾ Package: Dual DIP-8

Coupler

Parameter	Test condition	Symbol	Value	Unit
Storage temperature		T_{stg}	- 55 to + 150	$^{\circ}\text{C}$
Operating temperature		T_{amb}	- 40 to + 100	$^{\circ}\text{C}$
Lead solder temperature ¹⁾	for 10 sec.		260	$^{\circ}\text{C}$
Solder reflow temperature ²⁾	for 1 minute		260	$^{\circ}\text{C}$
Isolation test voltage	$t = 1.0\text{ sec.}$	V_{ISO}	5300	V_{RMS}

¹⁾ Package: DIP-8 through hole

²⁾ Package: DIP-8 SMD



Recommended Operating Conditions

Parameter	Test condition	Symbol	Min	Typ.	Max	Unit
Operating temperature		T_{amb}	- 40		100	°C
Supply voltage		V_{cc}	4.5		5.5	V
Input current low level		I_{FL}	0		250	μA
Input current high level		I_{FH}	5		15	mA
Logic high enable voltage		V_{EH}	2.0		V_{CC}	V
Logic low enable voltage		V_{EL}	0.0		0.8	V
Output pull up resistor		R_L	330		4 K	Ω
Fanout	$R_L = 1\text{ k}\Omega$	N			5	-

Electrical Characteristics

$T_{amb} = 25\text{ °C}$ and $V_{cc} = 5.5\text{ V}$, unless otherwise specified

Minimum and maximum values are testing requirements. Typical values are characteristics of the device and are the result of engineering evaluation. Typical values are for information only and are not part of the testing requirements.

Input

Parameter	Test condition	Symbol	Min	Typ.	Max	Unit
Input forward voltage	$I_F = 10\text{ mA}$	V_F	1.1	1.4	1.7	V
Reverse current	$V_R = 4.5\text{ V}$	I_R		1		μA
Input capacitance	$f = 1\text{ MHz}$, $V_F = 0\text{ V}$	C_I		55		pF

Output

Parameter	Test condition	Symbol	Min	Typ.	Max	Unit
High level supply current (single channel)	$V_E = 0.5\text{ V}$, $I_F = 0\text{ mA}$	I_{CCH}		4.1	7.0	mA
	$V_E = V_{CC}$, $I_F = 0\text{ mA}$	I_{CCH}		3.3	6.0	mA
High level supply current (dual channel)	$I_F = 0\text{ mA}$	I_{CCH}		8.2	14.0	mA
Low level supply current	$V_E = 0.5\text{ V}$, $I_F = 10\text{ mA}$	I_{CCL}		4.0	7.0	mA
	$V_E = V_{CC}$, $I_F = 10\text{ mA}$	I_{CCL}		3.3	6.0	mA
High level output current	$V_E = 2.0\text{ V}$, $V_O = 5.5\text{ V}$, $I_F = 250\text{ }\mu\text{A}$	I_{OH}		0.002	1	μA
Low level output voltage	$V_E = 2.0\text{ V}$, $I_F = 5\text{ mA}$, $I_{OL}(\text{sinking}) = 13\text{ mA}$	V_{OL}		0.2	0.6	V
Input threshold current	$V_E = 2.0\text{ V}$, $V_O = 5.5\text{ V}$, $I_{OL}(\text{sinking}) = 13\text{ mA}$	I_{TH}		2.4	5.0	mA
High level enable current	$V_E = 2.0\text{ V}$	I_{EH}		- 0.6	- 1.6	mA
Low level enable current	$V_E = 0.5\text{ V}$	I_{EL}		- 0.8	- 1.6	mA
High level enable voltage		V_{EH}	2.0			V
Low level enable voltage		V_{EL}			0.8	V

Switching Characteristics

Over Recommended Temperature ($T_a = -40$ to $+100$ °C), $V_{CC} = 5$ V, $I_F = 7.5$ mA unless otherwise specified.

All Typical at $T_a = 25$ °C, $V_{CC} = 5$ V.

Parameter	Test condition	Symbol	Min	Typ.	Max	Unit
Propagation delay time to high output level	$R_L = 350 \Omega$, $C_L = 15$ pF	t_{PLH}	20	48	75*	ns
		t_{PLH}			100	ns
Propagation delay time to low output level	$R_L = 350 \Omega$, $C_L = 15$ pF	t_{PHL}	25	50	75*	ns
		t_{PHL}			100	ns
Pulse width distortion	$R_L = 350 \Omega$, $C_L = 15$ pF	$ t_{PHL} - t_{PLH} $		2.9	35	ns
Propagation delay skew	$R_L = 350 \Omega$, $C_L = 15$ pF	t_{PSK}		8	40	ns
Output rise time (10 - 90 %)	$R_L = 350 \Omega$, $C_L = 15$ pF	t_r		23		ns
Output fall time (90 - 10 %)	$R_L = 350 \Omega$, $C_L = 15$ pF	t_f		7		ns
Propagation delay time of enable from V_{EH} to V_{EL}	$R_L = 350 \Omega$, $C_L = 15$ pF, $V_{EL} = 0$ V, $V_{EH} = 3$ V	t_{ELH}		12		ns
Propagation delay time of enable from V_{EL} to V_{EH}	$R_L = 350 \Omega$, $C_L = 15$ pF, $V_{EL} = 0$ V, $V_{EH} = 3$ V	t_{EHL}		11		ns

* 75ns applies to the 6N137 only, a JEDEC registered specification



Figure 1. Single Channel Test Circuit for t_{PLH} , t_{PHL} , t_r and t_f



Figure 2. Dual Channel Test Circuit for t_{PLH} , t_{PHL} , t_r and t_f



The Probe and Jig Capacitances are included in C_L

18975-1

Figure 3. Single Channel Test Circuit for t_{EHL} and t_{ELH}

Common Mode Transient Immunity

Parameter	Test condition	Symbol	Min	Typ.	Max	Unit
Common mode transient immunity (high)	$ V_{CM} = 10\text{ V}$, $V_{CC} = 5\text{ V}$, $I_F = 0\text{ mA}$, $V_{O(\min)} = 2\text{ V}$, $R_L = 350\ \Omega$, $T_{\text{amb}} = 25\text{ }^\circ\text{C}$ ¹⁾	$ CM_H $	100			V/ μs
	$ V_{CM} = 50\text{ V}$, $V_{CC} = 5\text{ V}$, $I_F = 0\text{ mA}$, $V_{O(\min)} = 2\text{ V}$, $R_L = 350\ \Omega$, $T_{\text{amb}} = 25\text{ }^\circ\text{C}$ ²⁾	$ CM_H $	5000	10000		V/ μs
	$ V_{CM} = 1\text{ kV}$, $V_{CC} = 5\text{ V}$, $I_F = 0\text{ mA}$, $V_{O(\min)} = 2\text{ V}$, $R_L = 350\ \Omega$, $T_{\text{amb}} = 25\text{ }^\circ\text{C}$ ³⁾	$ CM_H $	10000	15000		V/ μs
	$ V_{CM} = 10\text{ V}$, $V_{CC} = 5\text{ V}$, $I_F = 7.5\text{ mA}$, $V_{O(\max)} = 0.8\text{ V}$, $R_L = 350\ \Omega$, $T_{\text{amb}} = 25\text{ }^\circ\text{C}$ ¹⁾	$ CM_L $	100			V/ μs
	$ V_{CM} = 50\text{ V}$, $V_{CC} = 5\text{ V}$, $I_F = 7.5\text{ mA}$, $V_{O(\max)} = 0.8\text{ V}$, $R_L = 350\ \Omega$, $T_{\text{amb}} = 25\text{ }^\circ\text{C}$ ²⁾	$ CM_L $	5000	10000		V/ μs
	$ V_{CM} = 1\text{ kV}$, $V_{CC} = 5\text{ V}$, $I_F = 7.5\text{ mA}$, $V_{O(\max)} = 0.8\text{ V}$, $R_L = 350\ \Omega$, $T_{\text{amb}} = 25\text{ }^\circ\text{C}$ ³⁾	$ CM_L $	10000	15000		V/ μs

1) For 6N137 and SFH6750

2) For SFH6741 and SFH6751

3) For SFH6742 and SFH6752



Figure 4. Single Channel Test Circuit for Common Mode Transient Immunity



Figure 5. Dual Channel Test Circuit for Common Mode Transient Immunity

Safety and Insulation Ratings

As per IEC60747-5-2, §7.4.3.8.1, this optocoupler is suitable for "safe electrical insulation" only within the safety ratings. Compliance with the safety ratings shall be ensured by means of protective circuits.

Parameter	Test condition	Symbol	Min	Typ.	Max	Unit
Climatic Classification (according to IEC 68 part 1)				55/110/21		
Comparative Tracking Index		CTI	175		399	
V_{IOTM}			8000			V
V_{IORM}			630			V
P_{SI}					500	mW
I_{SI}					300	mA
T_{SI}					175	°C
Creepage	standard DIP-8		7			mm
Clearance	standard DIP-8		7			mm
Creepage	400mil DIP-8		8			mm
Clearance	400mil DIP-8		8			mm
Insulation thickness, reinforced rated	per IEC60950 2.10.5.1		0.2			mm

Typical Characteristics ($T_{amb} = 25^\circ\text{C}$ unless otherwise specified)

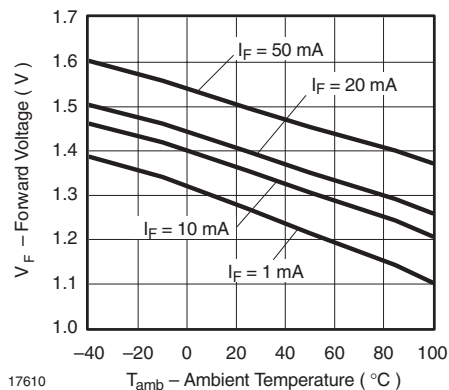

Figure 6. Forward Voltage vs. Ambient Temperature



Figure 7. Forward Voltage vs. Forward Current



Figure 8. Reverse Current vs. Ambient Temperature



Figure 11. Input Threshold ON Current vs. Ambient Temperature



Figure 9. Low Level Supply Current vs. Ambient Temperature



Figure 12. Input Threshold OFF Current vs. Ambient Temperature



Figure 10. High Level Supply Current vs. Ambient Temperature



Figure 13. Low Level Output Voltage vs. Ambient Temperature

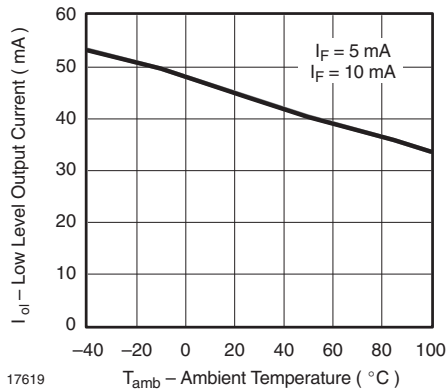

Figure 14. Low Level Output Current vs. Ambient Temperature



Figure 17. Propagation Delay vs. Ambient Temperature



Figure 15. High Level Output Current vs. Ambient Temperature

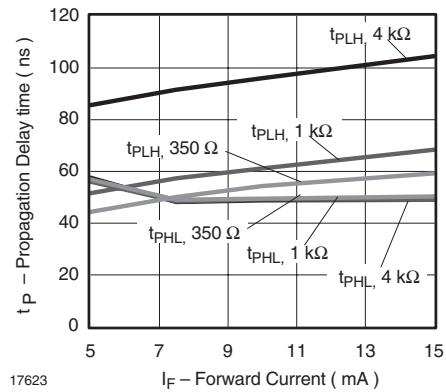

Figure 18. Propagation Delay vs. Forward Current

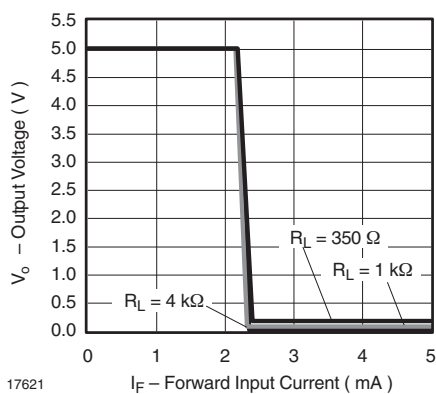

Figure 16. Output Voltage vs. Forward Input Current



Figure 19. Pulse Width Distortion vs. Ambient Temperature



Figure 20. Pulse Width Distortion vs. Forward Current



Figure 23. Enable Propagation Delay vs. Ambient Temperature



Figure 21. Rise and Fall Time vs. Ambient Temperature



Figure 22. Rise and Fall Time vs. Forward Current



Package Dimensions in Inches (mm)

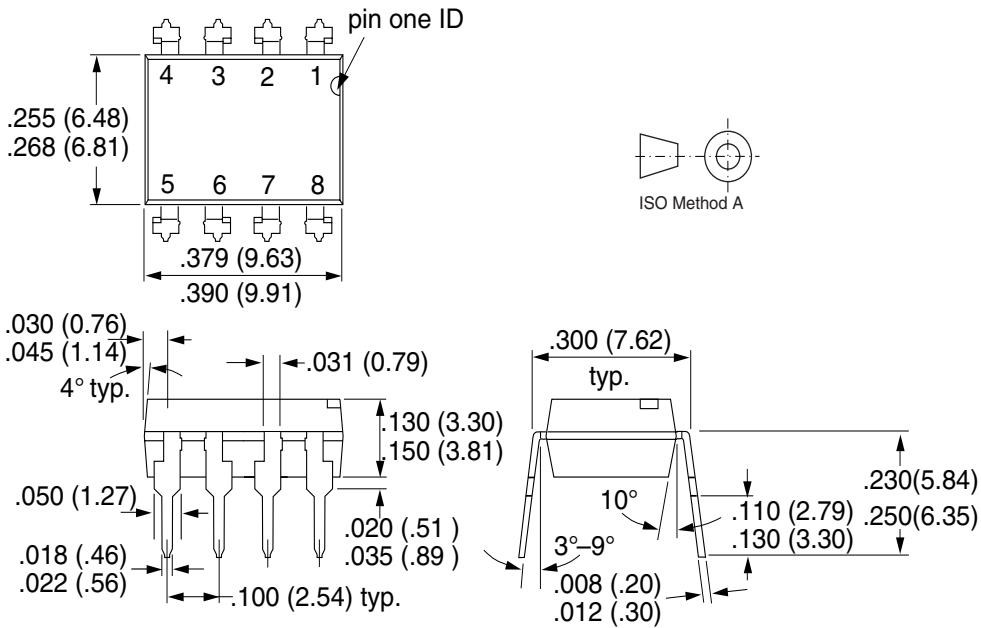

i178006

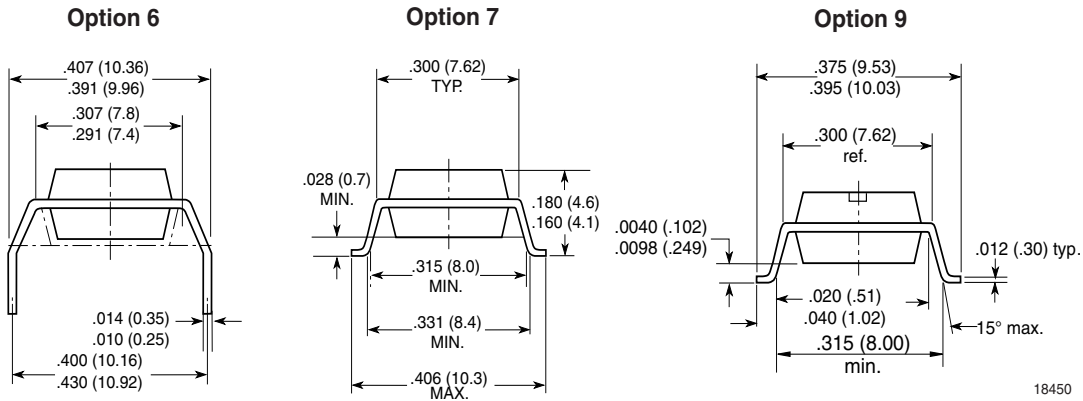

18450

Ozone Depleting Substances Policy Statement

It is the policy of Vishay Semiconductor GmbH to

1. Meet all present and future national and international statutory requirements.
2. Regularly and continuously improve the performance of our products, processes, distribution and operating systems with respect to their impact on the health and safety of our employees and the public, as well as their impact on the environment.

It is particular concern to control or eliminate releases of those substances into the atmosphere which are known as ozone depleting substances (ODSs).

The Montreal Protocol (1987) and its London Amendments (1990) intend to severely restrict the use of ODSs and forbid their use within the next ten years. Various national and international initiatives are pressing for an earlier ban on these substances.

Vishay Semiconductor GmbH has been able to use its policy of continuous improvements to eliminate the use of ODSs listed in the following documents.

1. Annex A, B and list of transitional substances of the Montreal Protocol and the London Amendments respectively
2. Class I and II ozone depleting substances in the Clean Air Act Amendments of 1990 by the Environmental Protection Agency (EPA) in the USA
3. Council Decision 88/540/EEC and 91/690/EEC Annex A, B and C (transitional substances) respectively.

Vishay Semiconductor GmbH can certify that our semiconductors are not manufactured with ozone depleting substances and do not contain such substances.

We reserve the right to make changes to improve technical design
and may do so without further notice.

Parameters can vary in different applications. All operating parameters must be validated for each customer application by the customer. Should the buyer use Vishay Semiconductors products for any unintended or unauthorized application, the buyer shall indemnify Vishay Semiconductors against all claims, costs, damages, and expenses, arising out of, directly or indirectly, any claim of personal damage, injury or death associated with such unintended or unauthorized use.

Vishay Semiconductor GmbH, P.O.B. 3535, D-74025 Heilbronn, Germany
Telephone: 49 (0)7131 67 2831, Fax number: 49 (0)7131 67 2423



6N137/ SFH6741 / 42 / 50 / 51 / 52

Vishay Semiconductors

This datasheet has been download from:

www.datasheetcatalog.com

Datasheets for electronics components.

Данный компонент на территории Российской Федерации

Вы можете приобрести в компании MosChip.

Для оперативного оформления запроса Вам необходимо перейти по данной ссылке:

<http://moschip.ru/get-element>

Вы можете разместить у нас заказ для любого Вашего проекта, будь то серийное производство или разработка единичного прибора.

В нашем ассортименте представлены ведущие мировые производители активных и пассивных электронных компонентов.

Нашей специализацией является поставка электронной компонентной базы двойного назначения, продукции таких производителей как XILINX, Intel (ex.ALTERA), Vicor, Microchip, Texas Instruments, Analog Devices, Mini-Circuits, Amphenol, Glenair.

Сотрудничество с глобальными дистрибьюторами электронных компонентов, предоставляет возможность заказывать и получать с международных складов практически любой перечень компонентов в оптимальные для Вас сроки.

На всех этапах разработки и производства наши партнеры могут получить квалифицированную поддержку опытных инженеров.

Система менеджмента качества компании отвечает требованиям в соответствии с ГОСТ Р ИСО 9001, ГОСТ РВ 0015-002 и ЭС РД 009

Офис по работе с юридическими лицами:

105318, г.Москва, ул.Щербаковская д.3, офис 1107, 1118, ДЦ «Щербаковский»

Телефон: +7 495 668-12-70 (многоканальный)

Факс: +7 495 668-12-70 (доб.304)

E-mail: info@moschip.ru

Skype отдела продаж:

moschip.ru

moschip.ru_4

moschip.ru_6

moschip.ru_9