

2A STEP DOWN SWITCHING REGULATOR

1 Features

- UP TO 2A STEP DOWN CONVERTER
- OPERATING INPUT VOLTAGE FROM 8V TO 55V
- PRECISE 3.3V ($\pm 1\%$) INTERNAL REFERENCE VOLTAGE
- OUTPUT VOLTAGE ADJUSTABLE FROM 3.3V TO 50V
- SWITCHING FREQUENCY ADJUSTABLE UP TO 300KHz
- VOLTAGE FEEDFORWARD
- ZERO LOAD CURRENT OPERATION
- INTERNAL CURRENT LIMITING (PULSE-BYPULSE AND HICCUP MODE)
- INHIBIT FOR ZERO CURRENT CONSUMPTION
- PROTECTION AGAINST FEEDBACK DISCONNECTION
- THERMAL SHUTDOWN
- SOFT START FUNCTION

2 DESCRIPTION

The L4978 is a step down monolithic power switching regulator delivering 2A at a voltage between 3.3V and 50V (selected by a simple external divider). Realized in BCD mixed technology, the device uses an internal power D-MOS transistor (with a typical $R_{ds(on)}$ of 0.25Ω) to obtain very high

Figure 1. Packages



Table 1. Order Codes

Part Number	Package
L4978	DIP-8
L4978D	SO16
L4978D013TR	SO16 in Tape & Reel

efficiency and high switching speed.

A switching frequency up to 300KHz is achievable (the maximum power dissipation of the packages must be observed). A wide input voltage range between 8V to 55V and output voltages regulated from 3.3V to 50V cover the majority of today's applications. Features of this new generations of DC-DC converter include pulse-by-pulse current limit, hiccup mode for short circuit protection, voltage feedforward regulation, soft-start, protection against feedback loop disconnection, inhibit for zero current consumption and thermal shutdown.

The device is available in plastic dual in line, DIP-8 for standard assembly, and SO16W for SMD assembly.

Figure 2. Typical Application Circuit

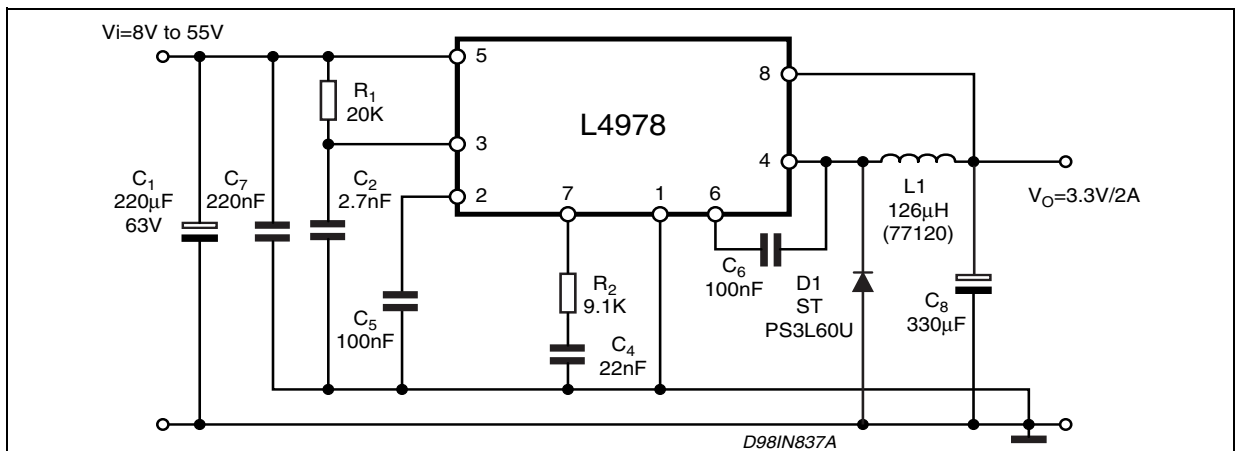

Table 2. Block Diagram



Figure 3. Pins Connection (Top view)



Table 3. Pin Description

N°	Pin	Name	Function
1	2	GND	Ground
2	3	SS_INH	A logic signal (active low) disables the device (sleep mode operation). A capacitor connected between this pin and ground determines the soft start time. When this pin is grounded disables the device (driven by open collector/drain).
3	4	OSC	An external resistor connected between the unregulated input voltage and this pin and a capacitor connected from this pin to ground fix the switching frequency. (Line feed forward is automatically obtained)

Table 3. Pin Description (continued)

N°	Pin	Name	Function
4	5, 6	OUT	Stepdown regulator output
5	11	V _{CC}	Unregulated DC input voltage
6	12	BOOT	A capacitor connected between this pin and OUT allows to drive the internal DMOS Transistors
7	13	COMP	E/A output to be used for frequency compensation
8	14	FB	Stepdown feedback input. Connecting directly to this pin results in an output voltage of 3.3V. An external resistive divider is required for higher output voltages.

(*) Pins 1, 7, 8, 9, 10, 15 and 16 are not internally, electrically connected to the die.

Table 4. Thermal Data

Symbol	Parameter	Minidip	SO16	Unit	
R _{th(j-amb)}	Thermal Resistance Junction to ambient	Max.	90 (*)	110 (*)	°C/W

(*) Package mounted on board.

Table 5. Absolute Maximum Ratings

Symbol		Parameter	Value	Unit
Minidip	SO16			
V ₅	V ₁₁	Input voltage	58	V
V ₄	V ₅ , V ₆	Output DC voltage Output peak voltage at t = 0.1ms f=200KHz	-1 -5	V V
I ₄	I ₅ , I ₆	Maximum output current	int. limit.	
V ₆ -V ₅	V ₁₂ -V ₁₁		14	V
V ₆	V ₁₂	Bootstrap voltage	70	V
V ₇	V ₁₃	Analogs input voltage (V _{CC} = 24V)	12	V
V ₂	V ₃	Analogs input voltage (V _{CC} = 24V)	13	V
V ₈	V ₁₄	(V _{CC} = 20V)	6 -0.3	V V
P _{tot}		Power dissipation a Tamb ≤ 60°C	DIP-8 SO16	
			1 0.8	W W
T _j , T _{stg}		Junction and storage temperature	-40 to 150	°C

Table 6. Electrical Characteristics

($T_j = 25^\circ\text{C}$, $C_{\text{OSC}} = 2.7\text{nF}$, $R_{\text{OSC}} = 20\text{k}\Omega$, $V_{\text{CC}} = 24\text{V}$, unless otherwise specified). "●" Specification Referred to T_j from 0 to 125°C

Symbol	Parameter	Test Condition		Min.	Typ.	Max.	Unit
DYNAMIC CHARACTERISTIC							
V_I	Operating input voltage range	$V_O = 3.3$ to 50V ; $I_O = 2\text{A}$	●	8		55	V
V_O	Output voltage	$I_O = 0.5\text{A}$		3.33	3.36	3.39	V
		$I_O = 0.2$ to 2A $V_{\text{CC}} = 8$ to 55V	●	3.292	3.36	3.427	V
V_d	Dropout voltage	$V_{\text{CC}} = 10\text{V}$; $I_O = 2\text{A}$			0.58	0.733	V
			●			1.173	V
I_l	Maximum limiting current	$V_{\text{CC}} = 8$ to 55V	●	2.5	3	3.5	A
	Efficiency	$V_O = 3.3\text{V}$; $I_O = 2\text{A}$			87		%
f_s	Switching frequency		●	90	100	110	KHz
SVRR	Supply voltage ripple rejection	$V_I = V_{\text{CC}} + 2V_{\text{RMS}}$; $V_O = V_{\text{ref}}$; $I_O = 2.5\text{A}$; $f_{\text{ripple}} = 100\text{Hz}$		60			dB
	Switching Frequency Stability vs. V_{CC}	$V_{\text{CC}} = 8$ to 55V			3	6	%
	Temp. stability of switching frequency	$T_j = 0$ to 125°C			4		%
SOFT START							
	Soft start charge current			30	40	50	μA
	Soft start discharge current			6	10	14	μA
INHIBIT							
V_{LL}	Low level voltage		●			0.9	V
I_{sLL}	Isorce Low level		●		5	15	μA
DC CHARACTERISTICS							
I_{qop}	Total operating quiescent current				4	6	mA
I_q	Quiescent current	Duty Cycle = 0; $V_{\text{FB}} = 3.8\text{V}$			2.5	3.5	mA
$I_{\text{qst-by}}$	Total stand-by quiescent current	$V_{\text{inh}} < 0.9\text{V}$			100	200	μA
		$V_{\text{CC}} = 55\text{V}$; $V_{\text{inh}} < 0.9\text{V}$			150	300	μA
ERROR AMPLIFIER							
V_{FB}	Voltage Feedback Input			3.33	3.36	3.39	V
R_L	Line regulation	$V_{\text{CC}} = 8$ to 55V			5	10	mV
	Ref. voltage stability vs temperature		●		0.4		$\text{mV}/^\circ\text{C}$
V_{OH}	High level output voltage	$V_{\text{FB}} = 2.5\text{V}$		10.3			V
V_{OL}	Low level output voltage	$V_{\text{FB}} = 3.8\text{V}$				0.65	V
$I_{\text{O source}}$	Source output current	$V_{\text{comp}} = 6\text{V}$; $V_{\text{FB}} = 2.5\text{V}$		180	220		μA
$I_{\text{O sink}}$	Sink output current	$V_{\text{comp}} = 6\text{V}$; $V_{\text{FB}} = 3.8\text{V}$		200	300		μA
I_b	Source bias current				2	3	μA
SVRR E/A	Supply voltage ripple rejection	$V_{\text{comp}} = V_{\text{FB}}$; $V_{\text{CC}} = 8$ to 55V		60	80		dB
	DC open loop gain	$R_L = \infty$		50	57		dB
g_m	Transconductance	$I_{\text{comp}} = -0.1$ to 0.1mA $V_{\text{comp}} = 6\text{V}$			2.5		mS

Table 6. Electrical Characteristics

($T_j = 25^\circ\text{C}$, $C_{\text{osc}} = 2.7\text{nF}$, $R_{\text{osc}} = 20\text{k}\Omega$, $V_{\text{CC}} = 24\text{V}$, unless otherwise specified). "●" Specification Referred to T_j from 0 to 125°C

Symbol	Parameter	Test Condition	Min.	Typ.	Max.	Unit
OSCILLATOR SECTION						
	Ramp Valley		0.78	0.85	0.92	V
	Ramp peak	$V_{\text{CC}} = 8\text{V}$	2	2.15	2.3	V
		$V_{\text{CC}} = 55\text{V}$	9	9.6	10.2	V
	Maximum duty cycle		95	97		%
	Maximum Frequency	Duty Cycle = 0% $R_{\text{osc}} = 13\text{k}\Omega$, $C_{\text{osc}} = 820\text{pF}$			300	kHz

Figure 4. Test and evaluation board circuit.

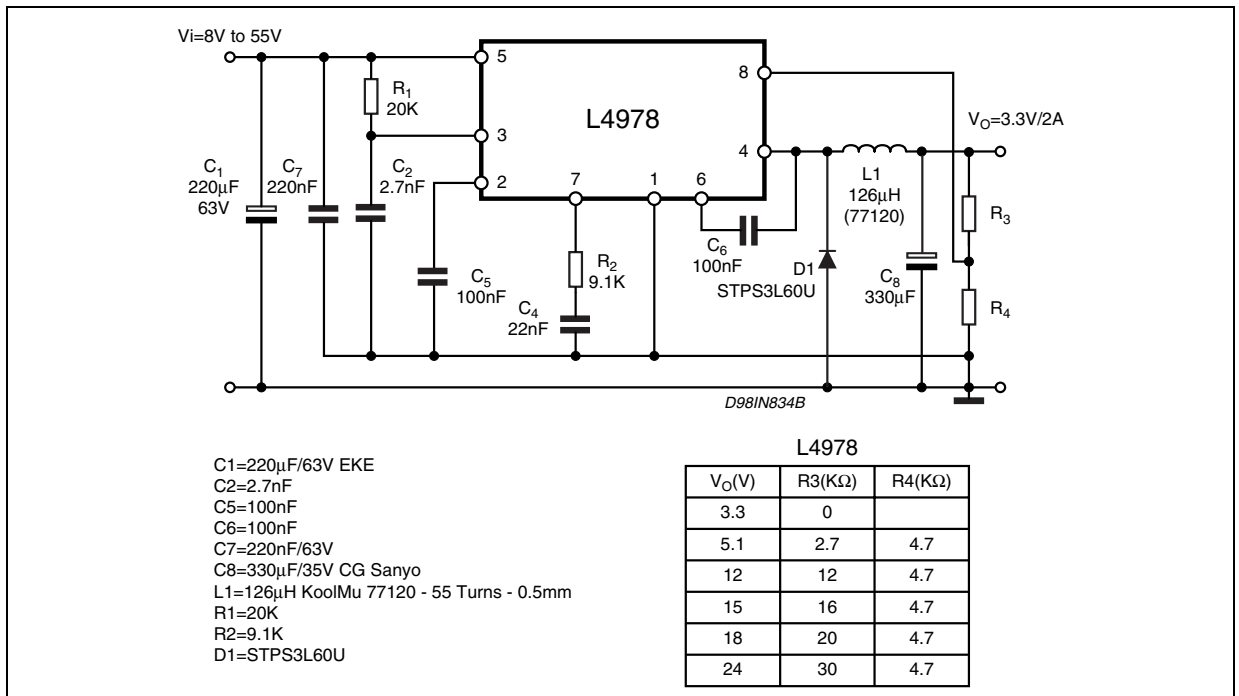

Figure 5. PCB and component layout of the figure 4.

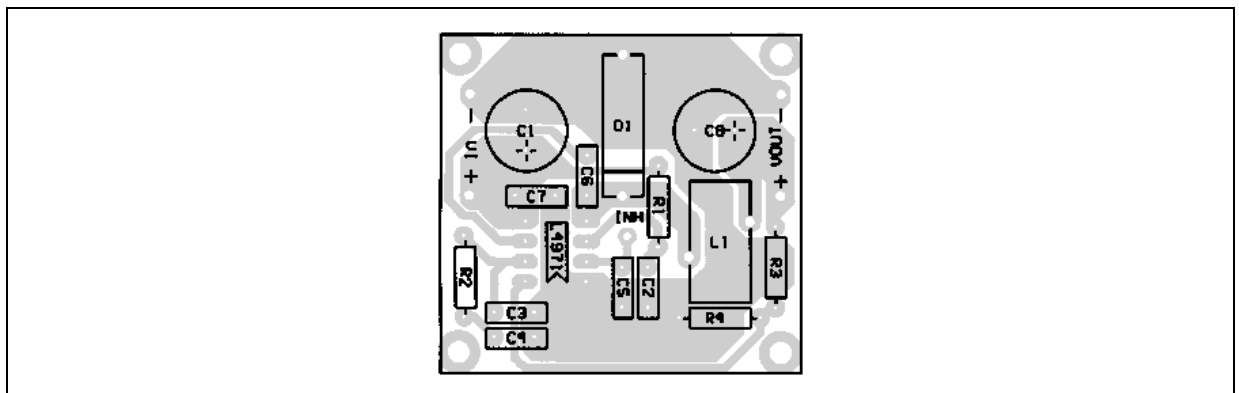

Figure 6. Quiescent drain current vs. input voltage.



Figure 9. Line Regulation



Figure 7. Quiescent current vs. junction temperature

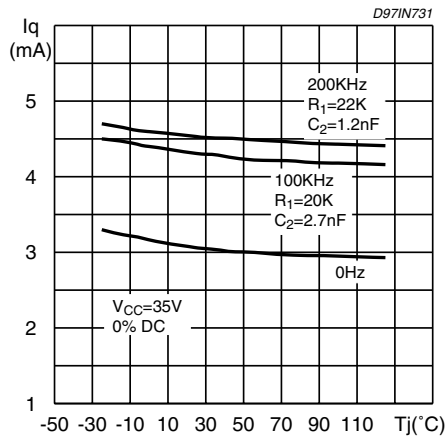

Figure 10. Load regulation

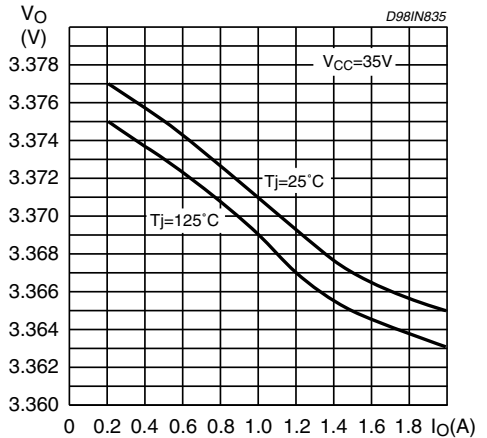

Figure 8. Stand by drain current vs. input voltage.

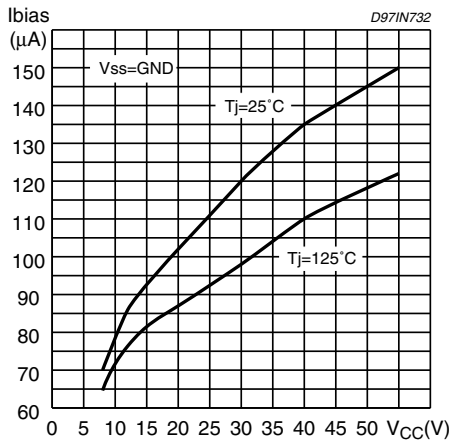

Figure 11. Switching frequency vs. R1 and C2

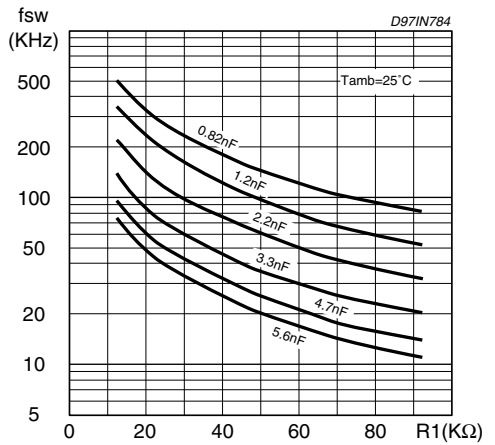

Figure 12. Switching Frequency vs. input voltage..

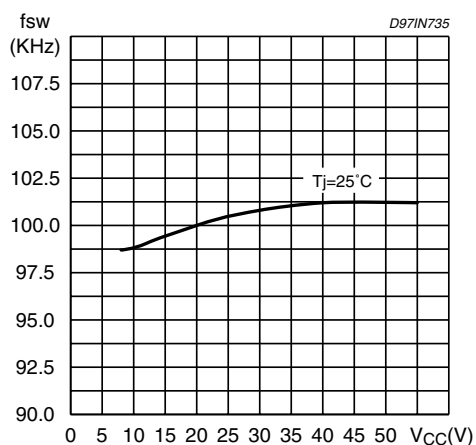

Figure 15. Efficiency vs output voltage.

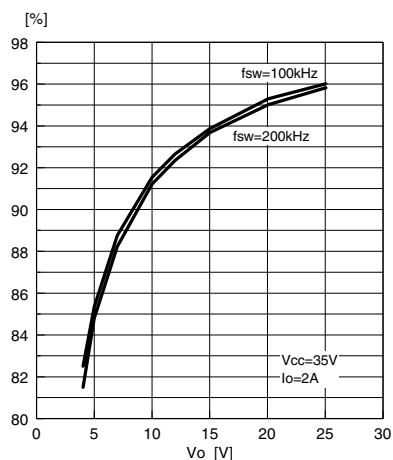

Figure 13. Switching frequency vs. junction temperature.

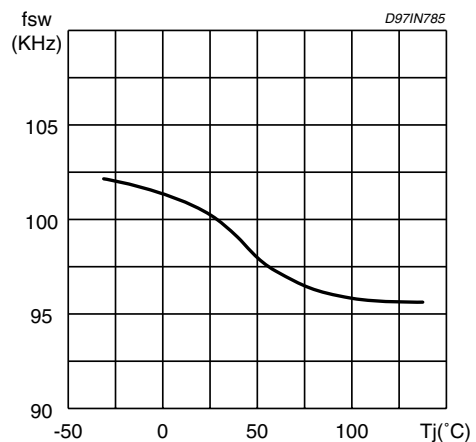

Figure 16. Efficiency vs. output current.

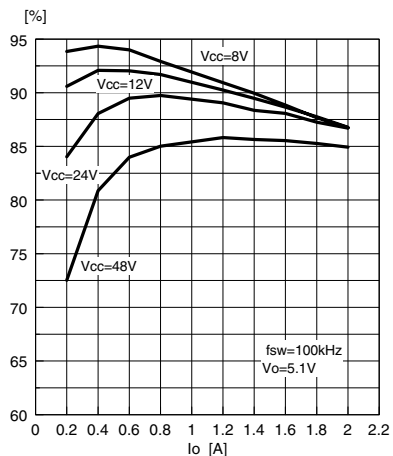

Figure 14. Dropout voltage between pin 5 and 4.

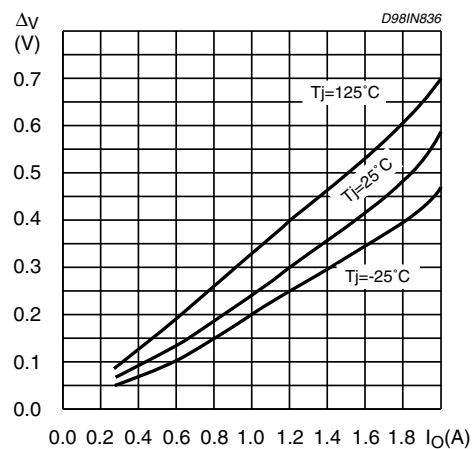

Figure 17. Efficiency vs. output current.

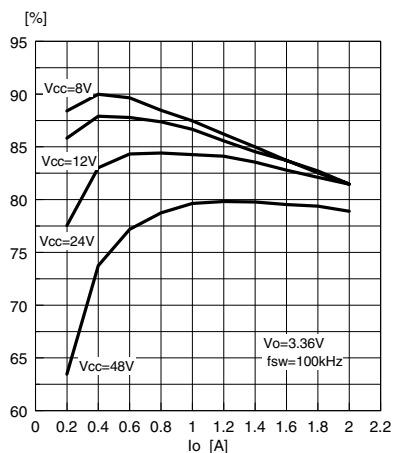

Figure 18. Efficiency vs. output current.

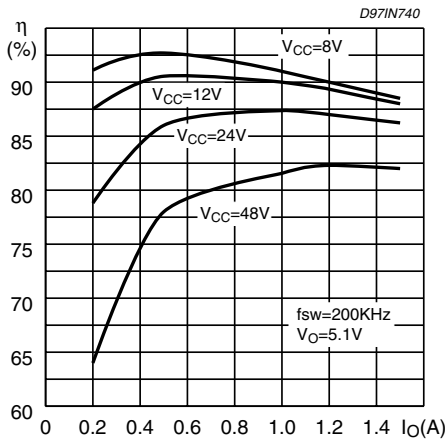

Figure 19. Efficiency vs. output current.

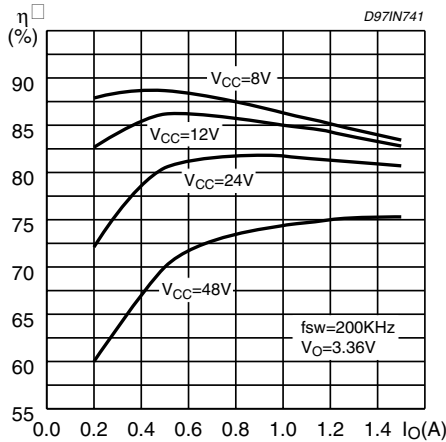

Figure 20. Efficiency vs. Vcc.

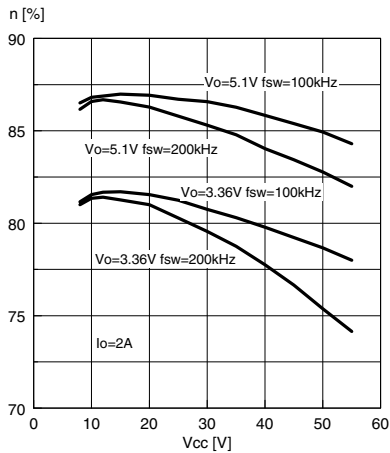

Figure 21. Power dissipation vs. Vcc.

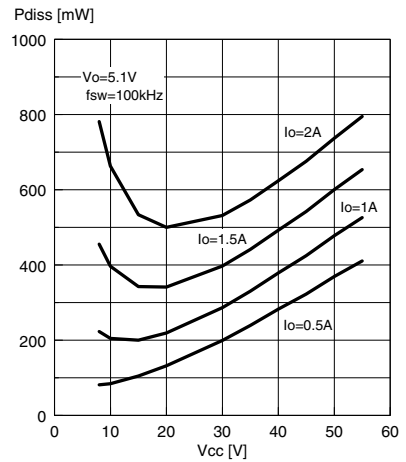

Figure 22. Device Power dissipation vs. V_o



Figure 23. Pulse by pulse limiting current vs. junction temperature..

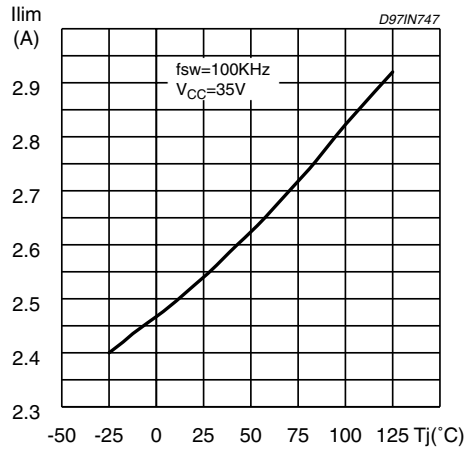

Figure 24. Load transient.

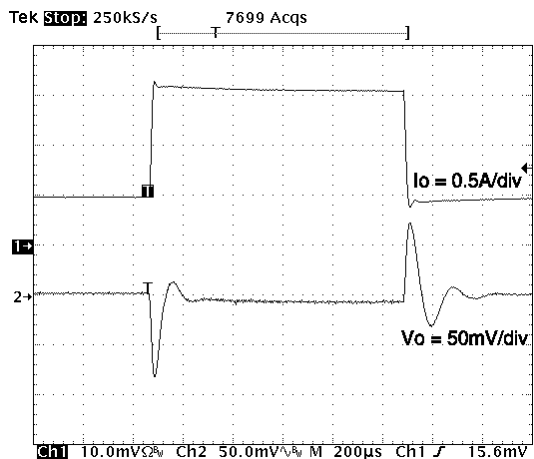

Figure 25. Line transient.

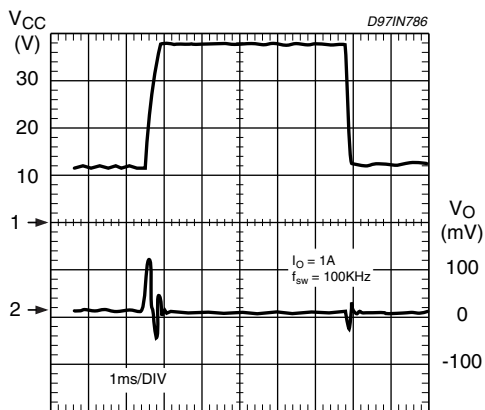

Figure 26. Soft start capacitor selection Vs inductor and V_{CCmax} .

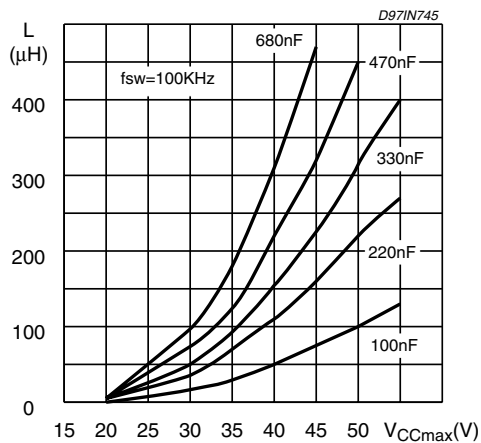

Figure 27. Soft start capacitor selection Vs inductor and V_{CCmax} .

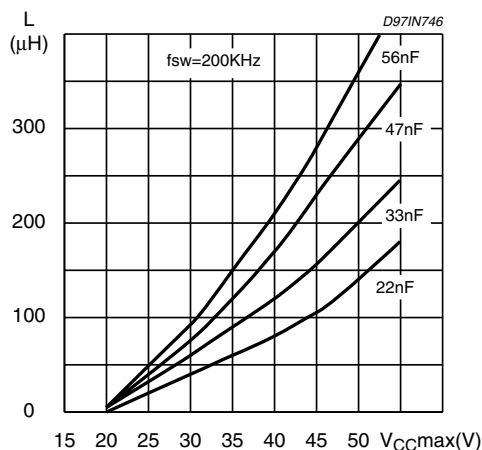
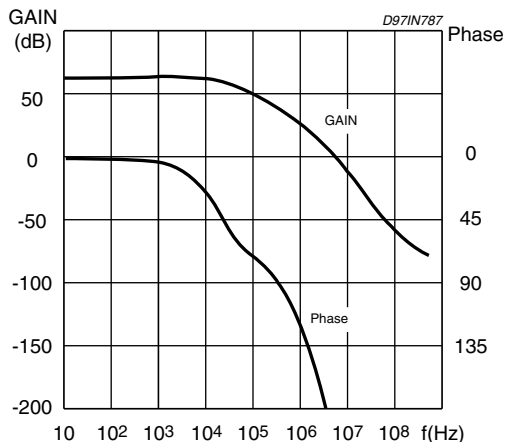

Figure 28. Open loop frequency and phase of error amplifier.



3 Package Informations

Figure 29. DIP-8 Mechanical Data & Package Dimensions

DIM.	mm			inch		
	MIN.	TYP.	MAX.	MIN.	TYP.	MAX.
A		3.32			0.131	
a1	0.51			0.020		
B	1.15		1.65	0.045		0.065
b	0.356		0.55	0.014		0.022
b1	0.204		0.304	0.008		0.012
D			10.92			0.430
E	7.95		9.75	0.313		0.384
e		2.54			0.100	
e3		7.62			0.300	
e4		7.62			0.300	
F			6.6			0.260
I			5.08			0.200
L	3.18		3.81	0.125		0.150
Z			1.52			0.060

OUTLINE AND MECHANICAL DATA



DIP-8

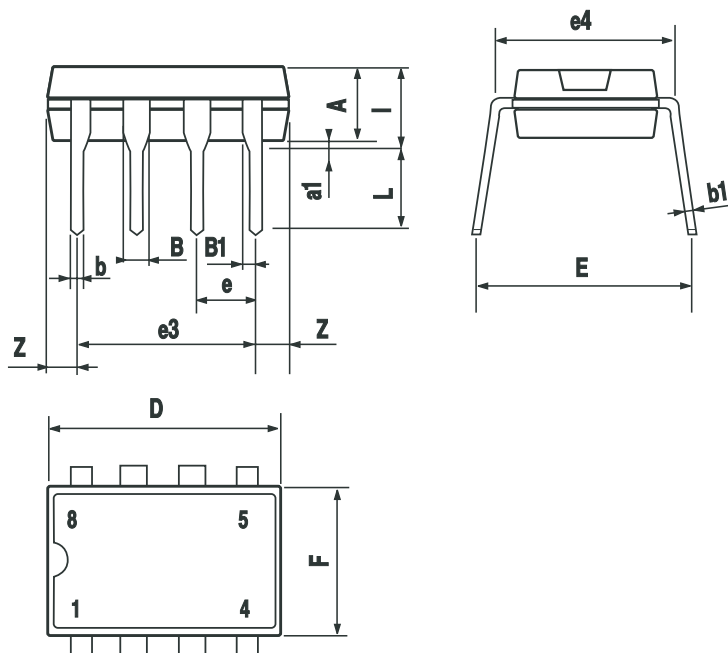

Figure 30. SO16 Wide Mechanical Data & Package Dimensions

DIM.	mm			inch		
	MIN.	TYP.	MAX.	MIN.	TYP.	MAX.
A	2.35		2.65	0.093		0.104
A1	0.10		0.30	0.004		0.012
B	0.33		0.51	0.013		0.200
C	0.23		0.32	0.009		0.013
D ⁽¹⁾	10.10		10.50	0.398		0.413
E	7.40		7.60	0.291		0.299
e		1.27			0.050	
H	10.0		10.65	0.394		0.419
h	0.25		0.75	0.010		0.030
L	0.40		1.27	0.016		0.050
k	0° (min.), 8° (max.)					
ddd			0.10			0.004

(1) "D" dimension does not include mold flash, protusions or gate burrs. Mold flash, protusions or gate burrs shall not exceed 0.15mm per side.

OUTLINE AND MECHANICAL DATA



SO16 (Wide)



Table 7. Revision History

Date	Revision	Description of Changes
October 2001	8	First Issue
May 2005	9	Modified D1 on the Fig. 4.

Information furnished is believed to be accurate and reliable. However, STMicroelectronics assumes no responsibility for the consequences of use of such information nor for any infringement of patents or other rights of third parties which may result from its use. No license is granted by implication or otherwise under any patent or patent rights of STMicroelectronics. Specifications mentioned in this publication are subject to change without notice. This publication supersedes and replaces all information previously supplied. STMicroelectronics products are not authorized for use as critical components in life support devices or systems without express written approval of STMicroelectronics.

The ST logo is a registered trademark of STMicroelectronics.
All other names are the property of their respective owners

© 2005 STMicroelectronics - All rights reserved

STMicroelectronics group of companies

Australia - Belgium - Brazil - Canada - China - Czech Republic - Finland - France - Germany - Hong Kong - India - Israel - Italy - Japan -
Malaysia - Malta - Morocco - Singapore - Spain - Sweden - Switzerland - United Kingdom - United States of America

www.st.com

Данный компонент на территории Российской Федерации

Вы можете приобрести в компании MosChip.

Для оперативного оформления запроса Вам необходимо перейти по данной ссылке:

<http://moschip.ru/get-element>

Вы можете разместить у нас заказ для любого Вашего проекта, будь то серийное производство или разработка единичного прибора.

В нашем ассортименте представлены ведущие мировые производители активных и пассивных электронных компонентов.

Нашей специализацией является поставка электронной компонентной базы двойного назначения, продукции таких производителей как XILINX, Intel (ex.ALTERA), Vicor, Microchip, Texas Instruments, Analog Devices, Mini-Circuits, Amphenol, Glenair.

Сотрудничество с глобальными дистрибьюторами электронных компонентов, предоставляет возможность заказывать и получать с международных складов практически любой перечень компонентов в оптимальные для Вас сроки.

На всех этапах разработки и производства наши партнеры могут получить квалифицированную поддержку опытных инженеров.

Система менеджмента качества компании отвечает требованиям в соответствии с ГОСТ Р ИСО 9001, ГОСТ РВ 0015-002 и ЭС РД 009

Офис по работе с юридическими лицами:

105318, г.Москва, ул.Щербаковская д.3, офис 1107, 1118, ДЦ «Щербаковский»

Телефон: +7 495 668-12-70 (многоканальный)

Факс: +7 495 668-12-70 (доб.304)

E-mail: info@moschip.ru

Skype отдела продаж:

moschip.ru

moschip.ru_4

moschip.ru_6

moschip.ru_9