

Power SMD LED PLCC-2

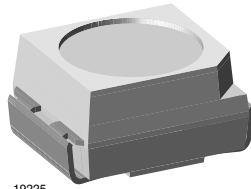

19225

DESCRIPTION

The VLM.33.. series is an advanced modification of the Vishay VLM.33.. series. It is designed to incorporate larger chips, therefore, capable of withstanding a 50 mA drive current.

The package of the VLM.33.. is the PLCC-2.

It consists of a lead frame which is embedded in a white thermoplast. The reflector inside this package is filled up with clear epoxy.

PRODUCT GROUP AND PACKAGE DATA

- Product group: LED
- Product series: SMD Power
- Package: PLCC-2
- Angle of half intensity: $\pm 60^\circ$

FEATURES

- Utilizing (AS) AlInGaP technology
- Available in 8 mm tape
- Luminous intensity and color categorized per packing unit
- Luminous intensity ratio per packing unit $I_{Vmax}/I_{Vmin} \leq 1.6$
- Thermal resistance $R = 400 \text{ K/W}$
- ESD-withstand voltage: up to 2 kV according to JESD22-A114-B
- Lead (Pb)-free device
- Preconditioning: acc. to JEDEC Level 2a
- Compatible with Reflow, vapor phase and wave solder processes according to CECC 00802 and J-STD-020C
- Component in accordance to RoHS 2002/95/EC and WEEE 2002/96/EC
- Automotive qualified AEC-Q101



APPLICATIONS

- Traffic signals and signs
- Interior and exterior lighting
- Dashboard illumination
- Indicator and backlighting purposes for audio, video, LCDs switches, symbols, illuminated advertising etc

PARTS TABLE

PART	COLOR, LUMINOUS INTENSITY	TECHNOLOGY
VLMR33T1U2-GS08	Amber, $I_V = (280 \text{ to } 710) \text{ mcd}$	AllnGaP on GaAs
VLMR33T1U2-GS18	Amber, $I_V = (280 \text{ to } 710) \text{ mcd}$	AllnGaP on GaAs
VLMR33R2U2-GS08	Amber, $I_V = (140 \text{ to } 710) \text{ mcd}$	AllnGaP on GaAs
VLMR33R2U2-GS18	Amber, $I_V = (140 \text{ to } 710) \text{ mcd}$	AllnGaP on GaAs
VLMS33S1T2-GS08	Super red, $I_V = (180 \text{ to } 450) \text{ mcd}$	AllnGaP on GaAs
VLMS33S1T2-GS18	Super red, $I_V = (180 \text{ to } 450) \text{ mcd}$	AllnGaP on GaAs
VLMS33S1U1-GS08	Super red, $I_V = (180 \text{ to } 560) \text{ mcd}$	AllnGaP on GaAs
VLMS33S1U1-GS18	Super red, $I_V = (180 \text{ to } 560) \text{ mcd}$	AllnGaP on GaAs
VLMO33S1T2-GS08	Soft orange, $I_V = (180 \text{ to } 450) \text{ mcd}$	AllnGaP on GaAs
VLMO33S1T2-GS18	Soft orange, $I_V = (180 \text{ to } 450) \text{ mcd}$	AllnGaP on GaAs
VLMO33T1U2-GS08	Soft orange, $I_V = (280 \text{ to } 710) \text{ mcd}$	AllnGaP on GaAs
VLMO33T1U2-GS18	Soft orange, $I_V = (280 \text{ to } 710) \text{ mcd}$	AllnGaP on GaAs
VLMO33R2U2-GS08	Soft orange, $I_V = (140 \text{ to } 710) \text{ mcd}$	AllnGaP on GaAs

PARTS TABLE		
PART	COLOR, LUMINOUS INTENSITY	TECHNOLOGY
VLMO33R2U2-GS18	Soft orange, $I_V = (140 \text{ to } 710) \text{ mcd}$	AllnGaP on GaAs
VLMY33T1U2-GS08	Yellow, $I_V = (280 \text{ to } 710) \text{ mcd}$	AllnGaP on GaAs
VLMY33T1U2-GS18	Yellow, $I_V = (280 \text{ to } 710) \text{ mcd}$	AllnGaP on GaAs
VLMY33R2U2-GS08	Yellow, $I_V = (140 \text{ to } 710) \text{ mcd}$	AllnGaP on GaAs
VLMY33R2U2-GS18	Yellow, $I_V = (140 \text{ to } 710) \text{ mcd}$	AllnGaP on GaAs

ABSOLUTE MAXIMUM RATINGS ¹⁾ VLM.33..				
PARAMETER	TEST CONDITION	SYMBOL	VALUE	UNIT
Reverse voltage ²⁾		V_R	5	V
DC Forward current	$T_{amb} \leq 73 \text{ }^\circ\text{C}$ (400 K/W)	I_F	50	mA
Power dissipation		P_V	130	mW
Junction temperature		T_j	125	$^\circ\text{C}$
Operating temperature range		T_{amb}	- 40 to + 100	$^\circ\text{C}$
Storage temperature range		T_{stg}	- 40 to + 100	$^\circ\text{C}$
Thermal resistance junction/ ambient	mounted on PC board (pad size > 16 mm ²)	R_{thJA}	400	K/W

Note:

1) $T_{amb} = 25 \text{ }^\circ\text{C}$, unless otherwise specified

2) Driving the LED in reverse direction is suitable for a short term application

OPTICAL AND ELECTRICAL CHARACTERISTICS ¹⁾ VLMR33.., AMBER							
PARAMETER	TEST CONDITION	PART	SYMBOL	MIN	TYP.	MAX	UNIT
Luminous intensity	$I_F = 30 \text{ mA}$	VLMR33T1U2	I_V	280		710	mcd
		VLMR33R2U2	I_V	140		710	mcd
Luminous flux/Luminous intensity			ϕ_V/I_V		3		mlm/mcd
Dominant wavelength	$I_F = 30 \text{ mA}$		λ_d	611	617	622	nm
Peak wavelength	$I_F = 30 \text{ mA}$		λ_p		624		nm
Spectral bandwidth at 50 % $I_{rel \text{ max}}$	$I_F = 30 \text{ mA}$		$\Delta\lambda$		18		nm
Angle of half intensity	$I_F = 30 \text{ mA}$		φ		± 60		deg
Forward voltage	$I_F = 30 \text{ mA}$		V_F	1.7	2.0	2.5	V
Reverse current	$V_R = 5 \text{ V}$		I_R		0.01	10	μA

Note:

1) $T_{amb} = 25 \text{ }^\circ\text{C}$, unless otherwise specified

OPTICAL AND ELECTRICAL CHARACTERISTICS¹⁾ VLMS33.., SUPER RED							
PARAMETER	TEST CONDITION	PART	SYMBOL	MIN	TYP.	MAX	UNIT
Luminous intensity	$I_F = 30 \text{ mA}$	VLMS33S1T2	I_V	180		450	mcd
		VLMS33S1U1	I_V	180		560	mcd
Luminous flux/Luminous intensity			ϕ_V/I_V		3		mlm/mcd
Dominant wavelength	$I_F = 30 \text{ mA}$		λ_d	626	630	638	nm
Peak wavelength	$I_F = 30 \text{ mA}$		λ_p		641		nm
Spectral bandwidth at 50 % $I_{rel \text{ max}}$	$I_F = 30 \text{ mA}$		$\Delta\lambda$		17		nm
Angle of half intensity	$I_F = 30 \text{ mA}$		φ		± 60		deg
Forward voltage	$I_F = 30 \text{ mA}$		V_F	1.7	2.0	2.5	V
Reverse current	$V_R = 5 \text{ V}$		I_R		0.01	10	μA

Note:

¹⁾ $T_{amb} = 25 \text{ }^\circ\text{C}$, unless otherwise specified

OPTICAL AND ELECTRICAL CHARACTERISTICS¹⁾ VLMO33.., SOFT ORANGE							
PARAMETER	TEST CONDITION	PART	SYMBOL	MIN	TYP.	MAX	UNIT
Luminous intensity	$I_F = 30 \text{ mA}$	VLMO33S1T2	I_V	180		450	mcd
		VLMO33T1U2	I_V	280		710	mcd
		VLMO33R2U2	I_V	140		710	mcd
Luminous flux/Luminous intensity			ϕ_V/I_V		3		mlm/mcd
Dominant wavelength	$I_F = 30 \text{ mA}$		λ_d	600	605	611	nm
Peak wavelength	$I_F = 30 \text{ mA}$		λ_p		611		nm
Spectral bandwidth at 50 % $I_{rel \text{ max}}$	$I_F = 30 \text{ mA}$		$\Delta\lambda$		17		nm
Angle of half intensity	$I_F = 30 \text{ mA}$		φ		± 60		deg
Forward voltage	$I_F = 30 \text{ mA}$		V_F	1.7	2.0	2.5	V
Reverse current	$V_R = 5 \text{ V}$		I_R		0.01	10	μA

Note:

¹⁾ $T_{amb} = 25 \text{ }^\circ\text{C}$, unless otherwise specified

OPTICAL AND ELECTRICAL CHARACTERISTICS¹⁾ VLMY33.., YELLOW							
PARAMETER	TEST CONDITION	PART	SYMBOL	MIN	TYP.	MAX	UNIT
Luminous intensity	$I_F = 30 \text{ mA}$	VLMY33T1U2	I_V	280		710	mcd
		VLMY33R2U2	I_V	140		710	mcd
Luminous flux/Luminous intensity			ϕ_V/I_V		3		mlm/mcd
Dominant wavelength	$I_F = 30 \text{ mA}$		λ_d	583	588	594	nm
Peak wavelength	$I_F = 30 \text{ mA}$		λ_p		590		nm
Spectral bandwidth at 50 % $I_{rel \text{ max}}$	$I_F = 30 \text{ mA}$		$\Delta\lambda$		18		nm
Angle of half intensity	$I_F = 30 \text{ mA}$		φ		± 60		deg
Forward voltage	$I_F = 30 \text{ mA}$		V_F	1.7	2.0	2.5	V
Reverse current	$V_R = 5 \text{ V}$		I_R		0.01	10	μA

Note:

¹⁾ $T_{amb} = 25 \text{ }^\circ\text{C}$, unless otherwise specified



COLOR CLASSIFICATION						
GROUP	DOMINANT WAVELENGTH (NM)					
	AMBER		SOFT ORANGE		YELLOW	
	MIN	MAX	MIN	MAX	MIN	MAX
1	611	618	598	601	581	584
2	614	622	600	603	583	586
3			602	605	585	588
4			604	607	587	590
5			606	609	589	592
6			608	611	591	594

Note:
Wavelengths are tested at a current pulse duration of 25 ms and an accuracy of ± 1 nm.

LUMINOUS INTENSITY CLASSIFICATION			
GROUP	LUMINOUS INTENSITY (MCD)		
	STANDARD	OPTIONAL	MAX
P	1	45	56
	2	56	71
Q	1	71	90
	2	90	112
R	1	112	140
	2	140	180
S	1	180	224
	2	224	280
T	1	280	355
	2	355	450
U	1	450	560
	2	560	710

CROSSING TABLE	
VISHAY	OSRAM
VLMS33S1T2	LST67B-S1T2
VLMS33S1U1	LST67B-T1U1

Note:
Luminous intensity is tested at a current pulse duration of 25 ms and an accuracy of ± 11 %.

The above type Numbers represent the order groups which include only a few brightness groups. Only one group will be shipped on each reel (there will be no mixing of two groups on each reel).

In order to ensure availability, single brightness groups will not be orderable.

In a similar manner for colors where wavelength groups are measured and binned, single wavelength groups will be shipped on any one reel.

In order to ensure availability, single wavelength groups will not be orderable.

TYPICAL CHARACTERISTICS

$T_{amb} = 25\text{ }^{\circ}\text{C}$, unless otherwise specified

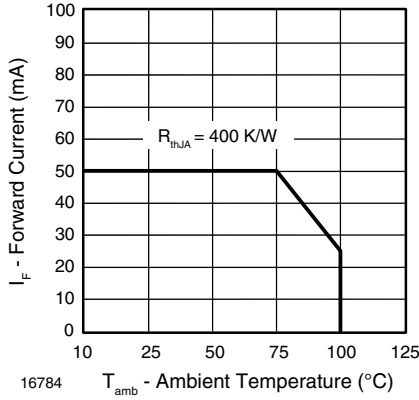

Figure 1. Forward Current vs. Ambient Temperature

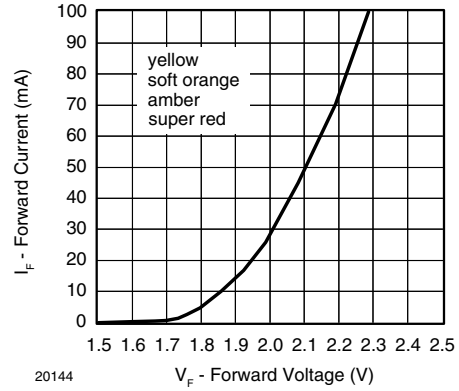

Figure 4. Forward Current vs. Forward Voltage

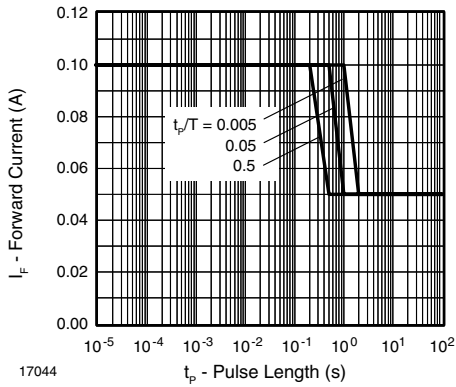

Figure 2. Forward Current vs. Pulse Length

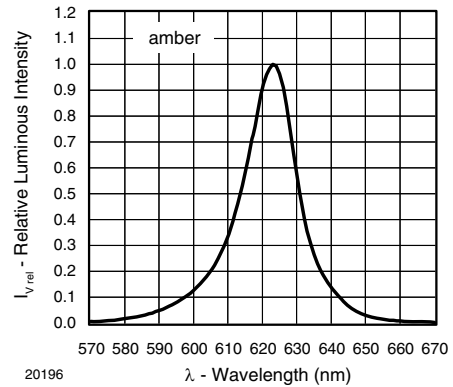

Figure 5. Relative Intensity vs. Wavelength

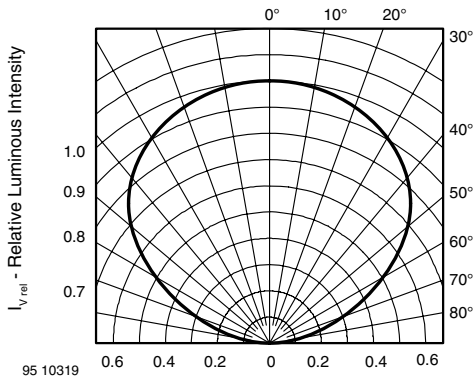

Figure 3. Rel. Luminous Intensity vs. Angular Displacement

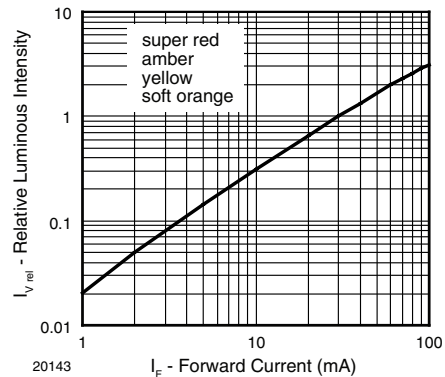

Figure 6. Relative Luminous Intensity vs. Forward Current

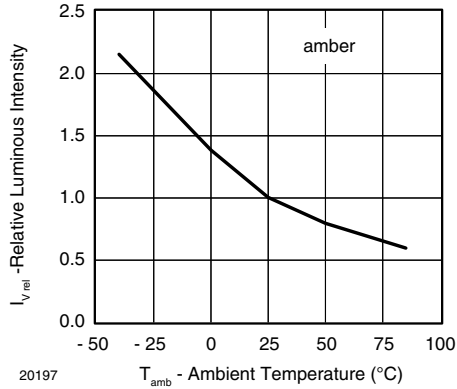

Figure 7. Relative Luminous Intensity vs. Amb. Temperature

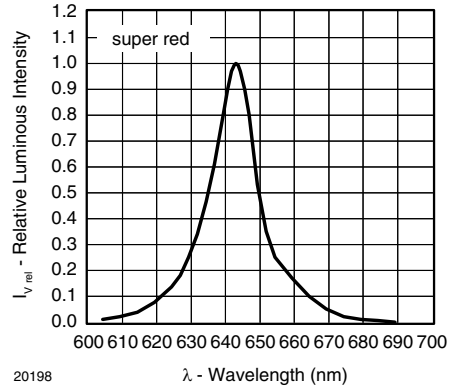

Figure 10. Relative Intensity vs. Wavelength

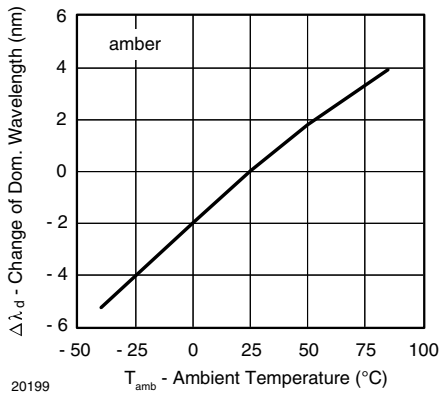

Figure 8. Change of Dominant Wavelength vs. Ambient Temperature

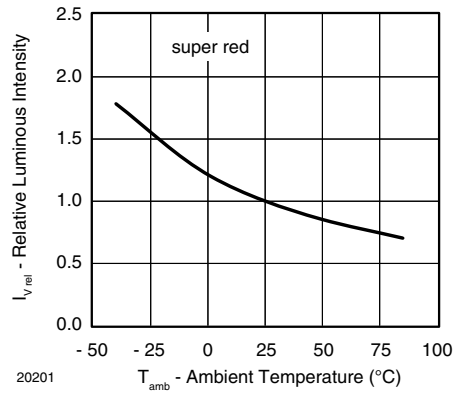

Figure 11. Relative Luminous Intensity vs. Amb. Temperature

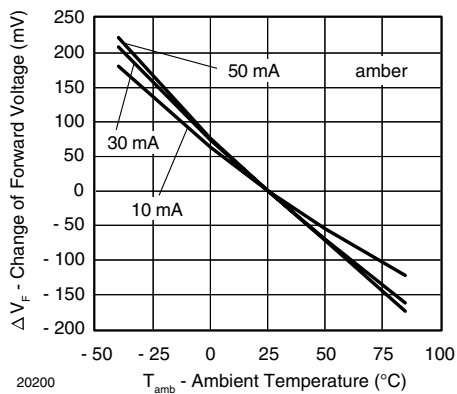

Figure 9. Change of Forward Voltage vs. Ambient Temperature

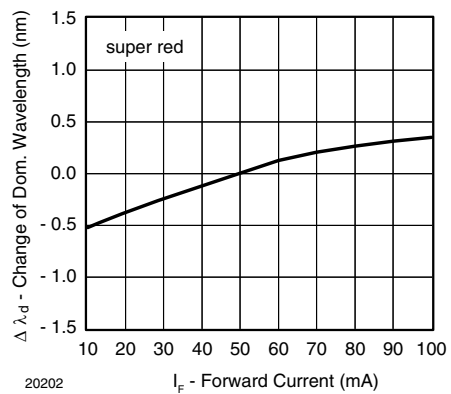
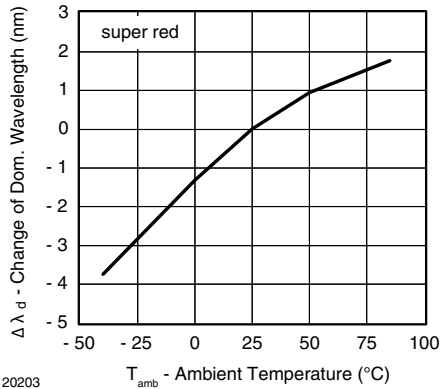
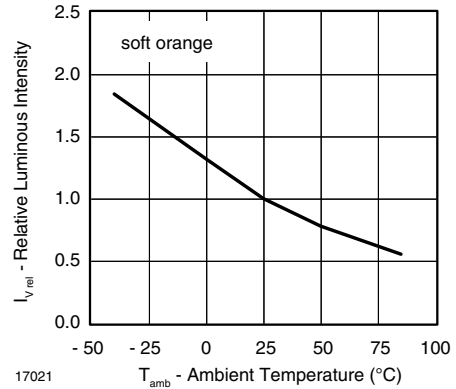

Figure 12. Change of Dominant Wavelength vs. Forward Current



20203
Figure 13. Change of Dominant Wavelength vs. Ambient Temperature



17021
Figure 16. Relative Luminous Intensity vs. Amb. Temperature

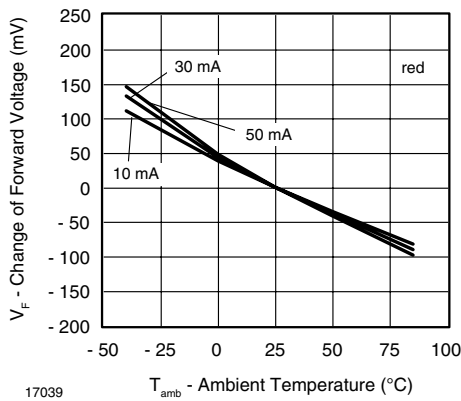

17039
Figure 14. Change of Forward Voltage vs. Ambient Temperature

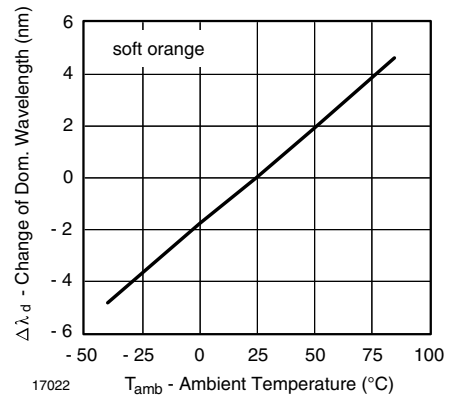

17022
Figure 17. Change of Dominant Wavelength vs. Ambient Temperature

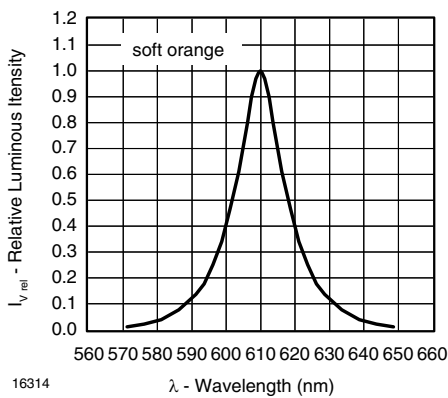

16314
Figure 15. Relative Intensity vs. Wavelength

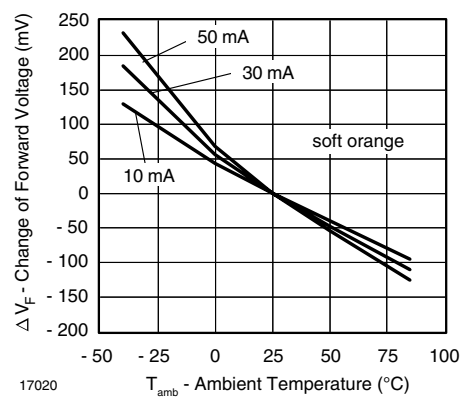

17020
Figure 18. Change of Forward Voltage vs. Ambient Temperature

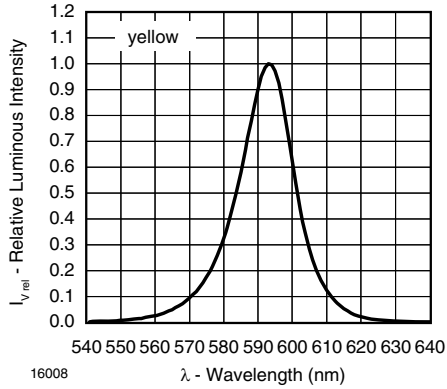

Figure 19. Relative Intensity vs. Wavelength

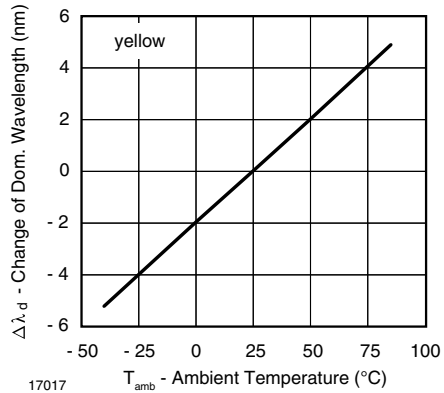

Figure 21. Change of Dominant Wavelength vs. Ambient Temperature

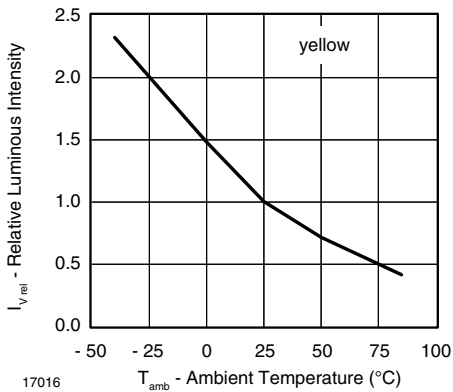

Figure 20. Relative Luminous Intensity vs. Amb. Temperature

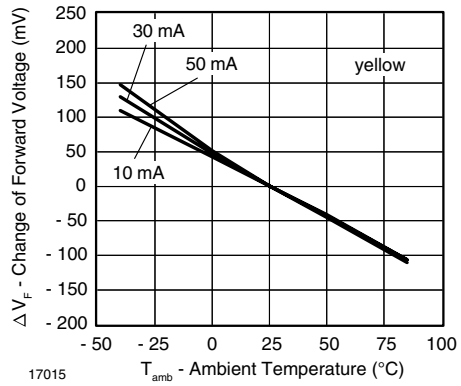
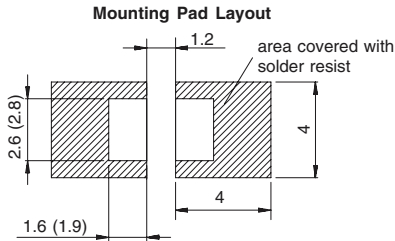
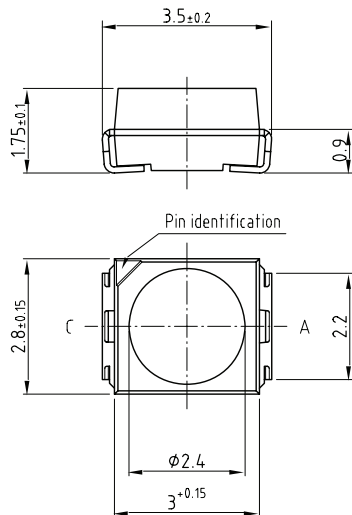

Figure 22. Change of Forward Voltage vs. Ambient Temperature

PACKAGE DIMENSIONS in millimeters



Drawing-No.: 6.541-5067.01-4
 Issue: 2; 27.06.06
 20541_1

METHOD OF TAPING/POLARITY AND TAPE AND REEL

SMD LED (VLM3 - SERIES)

Vishay's LEDs in SMD packages are available in an antistatic 8 mm blister tape (in accordance with DIN IEC 40 (CO) 564) for automatic component insertion. The blister tape is a plastic strip with impressed component cavities, covered by a top tape.

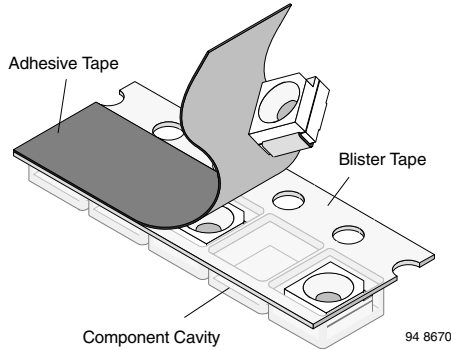

REEL PACKAGE DIMENSION IN MM FOR SMD LEDS, TAPE OPTION GS08 (= 1500 PCS.)

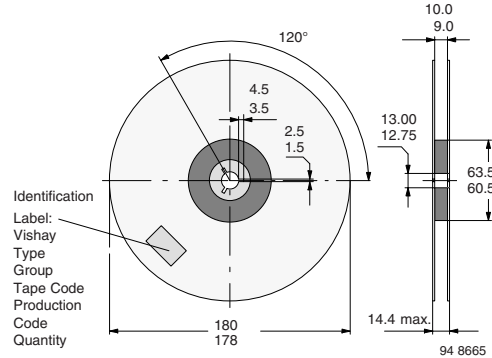

Figure 24. Reel dimensions - GS08

REEL PACKAGE DIMENSION IN MM FOR SMD LEDS, TAPE OPTION GS18 (= 8000 PCS.) PREFERRED

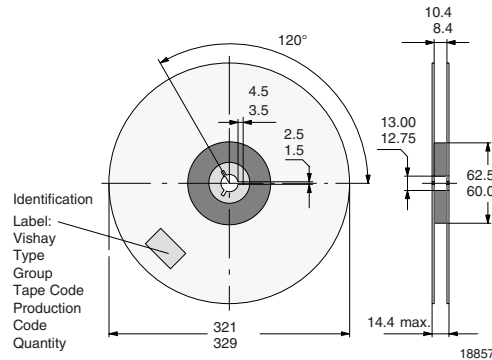

Figure 25. Reel dimensions - GS18

TAPING OF VLM.33..

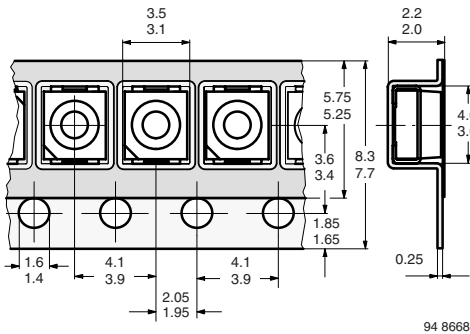

Figure 23. Tape dimensions in mm for PLCC-2

SOLDERING PROFILE

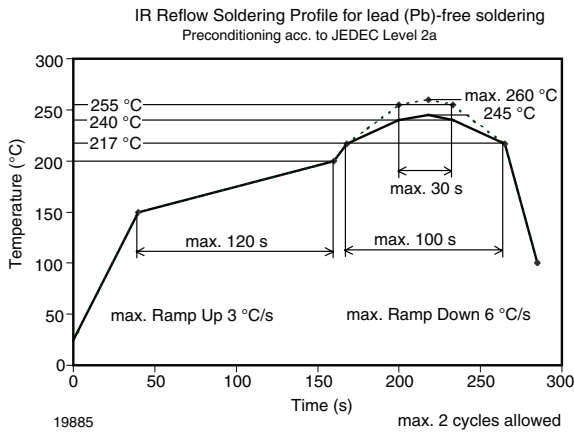

Figure 26. Vishay Lead (Pb)-free Reflow Soldering Profile (acc. to J-STD-020C)

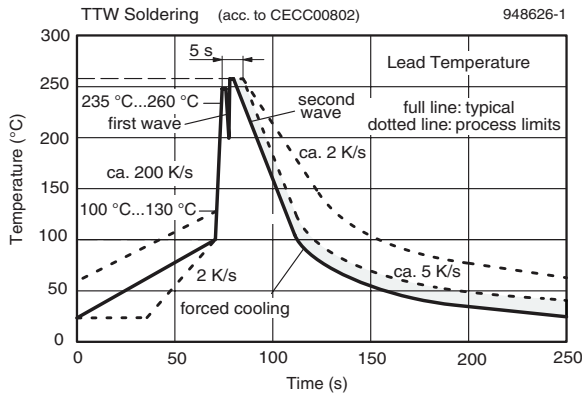
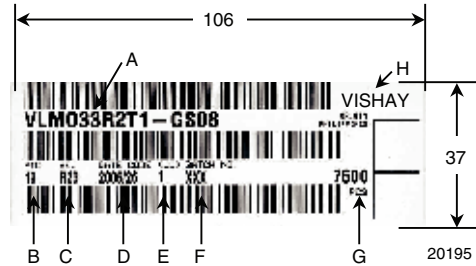

Figure 27. Double wave soldering of opto devices (all packages)

BARCODE-PRODUCT-LABEL EXAMPLE:



- A) Type of component
- B) Manufacturing Plant
- C) SEL - Selection Code (Bin):
e.g.: R2 = Code for Luminous Intensity Group
3 = Code for Color Group
- D) Date Code year/week
- E) Day Code (e.g. 1: Monday)
- F) Batch No.
- G) Total quantity
- H) Company Code

DRY PACKING

The reel is packed in an anti-humidity bag to protect the devices from absorbing moisture during transportation and storage.

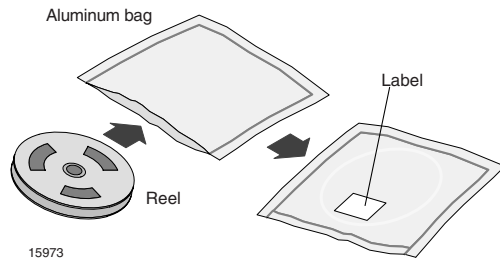

FINAL PACKING

The sealed reel is packed into a cardboard box. A secondary cardboard box is used for shipping purposes.

RECOMMENDED METHOD OF STORAGE

Dry box storage is recommended as soon as the aluminum bag has been opened to prevent moisture absorption. The following conditions should be observed, if dry boxes are not available:

- Storage temperature 10 °C to 30 °C
- Storage humidity $\leq 60\%$ RH max.

After more than 672 hours under these conditions moisture content will be too high for reflow soldering.

In case of moisture absorption, the devices will recover to the former condition by drying under the following condition:

192 hours at 40 °C + 5 °C/- 0 °C and < 5 % RH (dry air/nitrogen) or

96 hours at 60 °C + 5 °C and < 5 % RH for all device containers or

24 hours at 100 °C + 5 °C not suitable for reel or tubes.

An EIA JEDEC Standard JESD22-A112 Level 2a label is included on all dry bags.

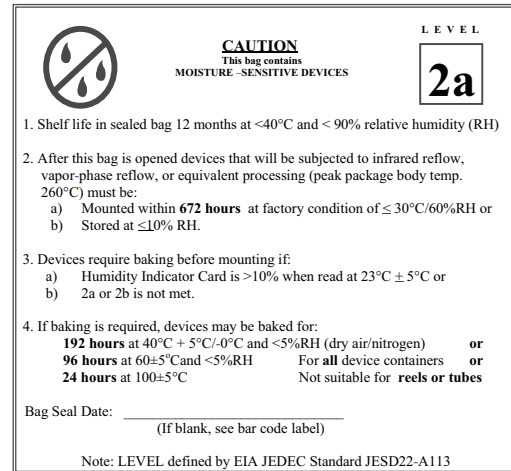

Example of JESD22-A112 Level 2a label

ESD PRECAUTION

Proper storage and handling procedures should be followed to prevent ESD damage to the devices especially when they are removed from the Antistatic Shielding Bag. Electro-Static Sensitive Devices warning labels are on the packaging.

VISHAY SEMICONDUCTORS STANDARD BAR-CODE LABELS

The Vishay Semiconductors standard bar-code labels are printed at final packing areas. The labels are on each packing unit and contain Vishay Semiconductors specific data.

OZONE DEPLETING SUBSTANCES POLICY STATEMENT

It is the policy of Vishay Semiconductor GmbH to

1. Meet all present and future national and international statutory requirements.
2. Regularly and continuously improve the performance of our products, processes, distribution and operating systems with respect to their impact on the health and safety of our employees and the public, as well as their impact on the environment.

It is particular concern to control or eliminate releases of those substances into the atmosphere which are known as ozone depleting substances (ODSs).

The Montreal Protocol (1987) and its London Amendments (1990) intend to severely restrict the use of ODSs and forbid their use within the next ten years. Various national and international initiatives are pressing for an earlier ban on these substances.

Vishay Semiconductor GmbH has been able to use its policy of continuous improvements to eliminate the use of ODSs listed in the following documents.

1. Annex A, B and list of transitional substances of the Montreal Protocol and the London Amendments respectively
2. Class I and II ozone depleting substances in the Clean Air Act Amendments of 1990 by the Environmental Protection Agency (EPA) in the USA
3. Council Decision 88/540/EEC and 91/690/EEC Annex A, B and C (transitional substances) respectively.

Vishay Semiconductor GmbH can certify that our semiconductors are not manufactured with ozone depleting substances and do not contain such substances.

We reserve the right to make changes to improve technical design
and may do so without further notice.

Parameters can vary in different applications. All operating parameters must be validated for each customer application by the customer. Should the buyer use Vishay Semiconductors products for any unintended or unauthorized application, the buyer shall indemnify Vishay Semiconductors against all claims, costs, damages, and expenses, arising out of, directly or indirectly, any claim of personal damage, injury or death associated with such unintended or unauthorized use.

Vishay Semiconductor GmbH, P.O.B. 3535, D-74025 Heilbronn, Germany



Disclaimer

All product specifications and data are subject to change without notice.

Vishay Intertechnology, Inc., its affiliates, agents, and employees, and all persons acting on its or their behalf (collectively, "Vishay"), disclaim any and all liability for any errors, inaccuracies or incompleteness contained herein or in any other disclosure relating to any product.

Vishay disclaims any and all liability arising out of the use or application of any product described herein or of any information provided herein to the maximum extent permitted by law. The product specifications do not expand or otherwise modify Vishay's terms and conditions of purchase, including but not limited to the warranty expressed therein, which apply to these products.

No license, express or implied, by estoppel or otherwise, to any intellectual property rights is granted by this document or by any conduct of Vishay.

The products shown herein are not designed for use in medical, life-saving, or life-sustaining applications unless otherwise expressly indicated. Customers using or selling Vishay products not expressly indicated for use in such applications do so entirely at their own risk and agree to fully indemnify Vishay for any damages arising or resulting from such use or sale. Please contact authorized Vishay personnel to obtain written terms and conditions regarding products designed for such applications.

Product names and markings noted herein may be trademarks of their respective owners.

Данный компонент на территории Российской Федерации

Вы можете приобрести в компании MosChip.

Для оперативного оформления запроса Вам необходимо перейти по данной ссылке:

<http://moschip.ru/get-element>

Вы можете разместить у нас заказ для любого Вашего проекта, будь то серийное производство или разработка единичного прибора.

В нашем ассортименте представлены ведущие мировые производители активных и пассивных электронных компонентов.

Нашей специализацией является поставка электронной компонентной базы двойного назначения, продукции таких производителей как XILINX, Intel (ex.ALTERA), Vicor, Microchip, Texas Instruments, Analog Devices, Mini-Circuits, Amphenol, Glenair.

Сотрудничество с глобальными дистрибьюторами электронных компонентов, предоставляет возможность заказывать и получать с международных складов практически любой перечень компонентов в оптимальные для Вас сроки.

На всех этапах разработки и производства наши партнеры могут получить квалифицированную поддержку опытных инженеров.

Система менеджмента качества компании отвечает требованиям в соответствии с ГОСТ Р ИСО 9001, ГОСТ РВ 0015-002 и ЭС РД 009

Офис по работе с юридическими лицами:

105318, г.Москва, ул.Щербаковская д.3, офис 1107, 1118, ДЦ «Щербаковский»

Телефон: +7 495 668-12-70 (многоканальный)

Факс: +7 495 668-12-70 (доб.304)

E-mail: info@moschip.ru

Skype отдела продаж:

moschip.ru

moschip.ru_4

moschip.ru_6

moschip.ru_9