

## Description

The smart power relay ESR10 Micro (Electronic Standard Relay) is a solid state relay which can replace electro-mechanical relays.

The ESR10 is a plus switching (high side switch) closing relay (NO) in an ISO Micro automotive relay enclosure.

It allows bipolar control by a positive voltage. This space-saving relay is available in three power classes:

- 10 A for max. 85° C / (12 and 24) Vdc
- 17 A for max. 105° C / (12 and 24) Vdc
- 30 A for max. 85° C / 12 Vdc

## Applications

The ESR10 helps to switch loads whose current demand is too high to be connected directly to the controlgear. The switching function of the ESR10 is completely noiseless. This allows installation in the vehicle's interior.

The ESR10 Micro is suitable for all applications in DC 12 V or 24 V electrical systems where valves, motors, lamps etc. have to be switched:

- Road vehicles (passenger cars, bicycles, trucks, buses, working vehicles and emergency cars, special vehicles)
- Construction vehicles and agricultural vehicles
- Watercraft (ships, sailing boats, motor yachts etc.)

## Benefits

- The low current consumption, particularly in the ON condition, helps to reduce gas consumption as well as CO<sub>2</sub> emissions.
- The solid state relay switches silently and features wear-free operation of all loads with an extremely long life span.

## Order numbering code

Type No.	Description
ESR10	electronic standard relay
<b>N</b>	<b>Protection (characteristic curve)</b> not protected, only short circuit protection
<b>C2</b>	<b>Type of enclosure</b> Micro enclosure with hexagonal latching lugs
<b>A4</b>	<b>Terminals (pins)</b> standard automotive, 4-pole (ISO)
<b>HB</b>	<b>Load and control</b> high-side-switch (HSS), bipolar control
<b>00</b>	<b>Sub type</b> standard
<b>D1</b>	<b>System voltage</b> DC 12 V
<b>D2</b>	DC 24 V
<b>10 A</b>	<b>Current rating (at 25°C)</b> 10 A
<b>17 A</b>	17 A
<b>30 A *</b>	30 A * (12 V only)
ESR10 - N C2 A4 HB - 00 - D1 - 10A	ordering example

\* The 30A version of the ESR10 Micro will only be available upon request and for high volume projects (> 5000 pcs). Small quantities cannot be ordered.



ESR10 Micro

## Technical data (25 °C) – ESR10 Micro 10 A

### Voltage supply LINE+

System voltage	U <sub>B</sub>	DC 12 V / DC 24 V
Operating voltage		6...16 V / 10...32 V
Closed current <sup>1)</sup>	OFF	8 µA

### Load circuit LOAD

Load output		MOSFET, high side switching (HSS)
Load types		resistive, inductive and capacitive
Protective function		short circuit proof, temperature disconnection (pulsing)
Current rating	I <sub>N</sub>	10 A
Voltage drop <sup>1)</sup>	U <sub>ON</sub>	75 mV
Max. short circuit current		60 A (L/R = 3 ms)

### Control input IN+

Control voltage	ON	12 V: ±6...16 V; 24 V: ±10...32 V
	OFF	12 V: ±0...2 V; 24 V: ±0...4 V
Control current <sup>1) 2)</sup>		10 mA (at 13.5 V respectively 27 V) (derating see chart)
Switching frequency	max.	see chart
Rising edge		< 5 ms

### General data

Reverse polarity protection circuit, load circuit	load	yes (reverse polarity conductive) <sup>3)</sup>
Cycle times <sup>1)</sup>	t <sub>ON</sub>	0.5 ms
	t <sub>OFF</sub>	0.5 ms
Temperature range		-40 °C...85 °C
Dimensions		ISO Standard Micro (with retaining lugs)
	plugged in	26 x 15.5 x 26 mm
	including contacts	26 x 15.5 x 37 mm
Mass <sup>1)</sup>		15 g

<sup>1)</sup> typically

<sup>2)</sup> The upstream controlgear may misconstrue the situation as "wire break" due to the extremely low control current. In this case the trigger threshold should be adjusted.

<sup>3)</sup> In the event of reverse polarity connection, the MOSFET will switch through automatically for self-protection.

**Technical data (25 °C) – ESR10 Micro 17 A**

<b>Voltage supply LINE+</b>		
System voltage	U <sub>B</sub>	DC 12 V / DC 24 V
Operating voltage		6...16 V / 10...32 V
Closed current <sup>1)</sup>	OFF	8 µA
<b>Load circuit LOAD</b>		
Load output		MOSFET, high side switching (HSS)
Load types		resistive, inductive and capacitive
Protective function		short circuit proof, temperature disconnection (pulsing)
Current rating	I <sub>N</sub>	17 A
Voltage drop <sup>1)</sup>	U <sub>ON</sub>	75 mV
Max. short circuit current		100 A (L/R = 3 ms)
<b>Control input IN+</b>		
Control voltage	ON OFF	12 V: ±6...16 V; 24 V: ±10...32 V 12 V: ±0...2 V; 24 V: ±0...4 V
Control current <sup>1) 2)</sup>		10 mA (at 13.5 V respectively 27 V) (derating see chart)
Switching frequency	max.	see chart
Rising edge		< 5 ms
<b>General data</b>		
Reverse polarity protection circuit, load circuit	load	yes (reverse polarity conductive) <sup>3)</sup>
Cycle times <sup>1)</sup>	t <sub>ON</sub> t <sub>OFF</sub>	0.5 ms 0.5 ms
Temperature range		-40 °C...105 °C
Dimensions		ISO Standard Micro (with retaining lugs)
	plugged in	26 x 15.5 x 26 mm
	including contacts	26 x 15.5 x 37 mm
Mass <sup>1)</sup>		15 g

**Technical data (25 °C) – ESR10 Micro 30 A**

<b>Voltage supply LINE+</b>		
System voltage	U <sub>B</sub>	DC 12 V
Operating voltage		6...16 V
Closed current <sup>1)</sup>	OFF	5 µA
<b>Load circuit LOAD</b>		
Load output		MOSFET, high side switching (HSS)
Load types		resistive, inductive and capacitive
Protective function		short circuit proof, temperature disconnection (pulsing)
Current rating	I <sub>N</sub>	30 A
Voltage drop <sup>1)</sup>	U <sub>ON</sub>	50 mV
Max. short circuit current		100 A (L/R = 3 ms)
<b>Control input IN+</b>		
Control voltage	ON OFF	12 V: ±6...16 V 12 V: ±0...2 V
Control current <sup>1) 2)</sup>		10 mA (at 13.5 V respectively 27 V) (derating see chart)
Switching frequency	max.	see chart
Rising edge		< 5 ms
<b>General data</b>		
Reverse polarity protection circuit, load circuit	load	yes (reverse polarity conductive) <sup>3)</sup>
Cycle times <sup>1)</sup>	t <sub>ON</sub> t <sub>OFF</sub>	0.5 ms 3.5 ms
Temperature range		-40 °C...85 °C
Dimensions		ISO Standard Micro (with retaining lugs)
	plugged in	26 x 15.5 x 26 mm
	including contacts	26 x 15.5 x 37 mm
Mass <sup>1)</sup>		15 g

**Important:** The 30A version of the ESR10 Micro will only be available upon request and for high volume projects (> 5000 pcs). Small quantities cannot be ordered.

**Approvals**

Authority	Approval mark	Regulation
KBA	E1	ECE R 10

## Qualifications

### ESR10 Micro 10 A/12 V variant, VW

VW80000:2013-06 (LV124)  
TL81000:2013-02

### ESR10 Micro 10 A/12 V variant, GM

GMW 15267  
GMW 3097

### ESR10 Micro 10 A, 17 A, 30 A / 24 V

Environmental tests to LV124  
(Specification and severity to VW80000: 2013-06)

Electrical tests to ISO 16750-2

## Pin assignment

### ESR10 Micro

LINE +	3	(30)	$U_B$
$IN_a$	1	(86/31)	control input
$IN_b$	2	(31/86)	ground
LOAD	5	(88a)	load output

( )  $\hat{=}$  Automotive terminal designation

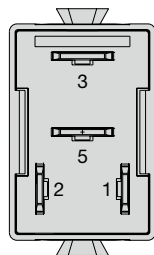

## Dimensions

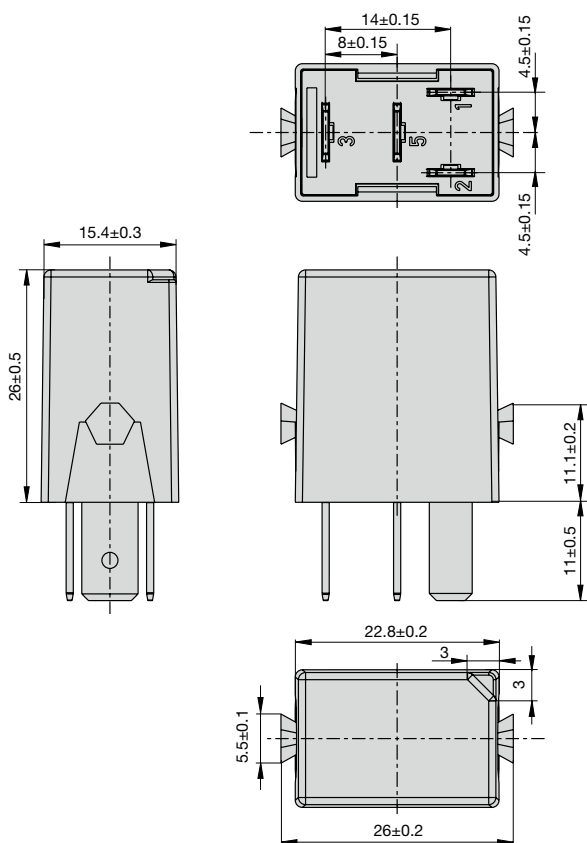

Pin assignment is in accordance with ISO 7588  
3 and 5 - blade terminals 6.3 x 0.8 [mm]  
1 and 2 - blade terminals 4.8 x 0.8 [mm]

## Schematic diagram

### Alternative control of bipolar control inputs

Control inputs	$IN_a$	$IN_b$
alternative 1	$U_B$	GND
alternative 2	GND	$U_B$

#### alternative 1

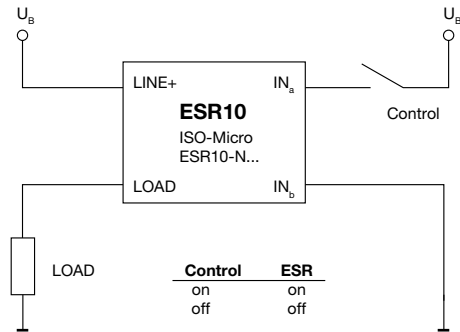

#### alternative 2

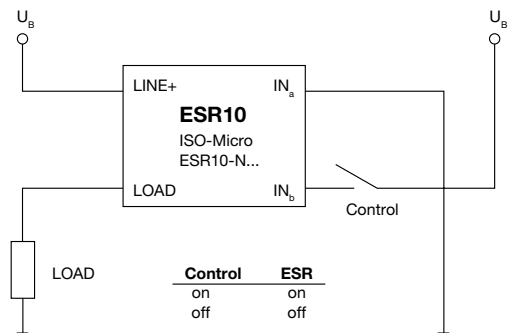

**Derating**

Load current for – 10 A variant

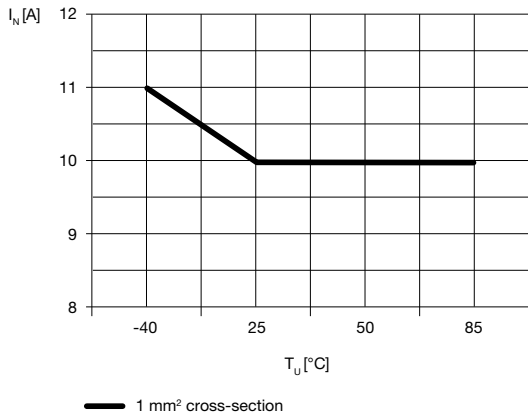

Load current for – 30 A variant

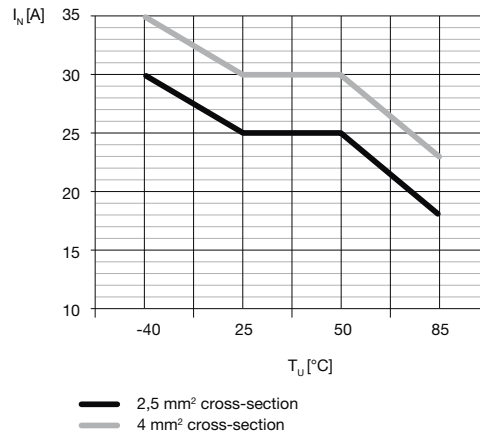

Load current for 17 A variant

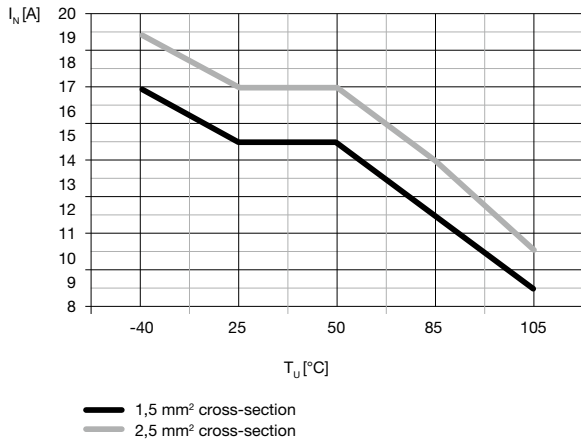

Control current for 12 V – 10 A / 17 A / 30 A variant

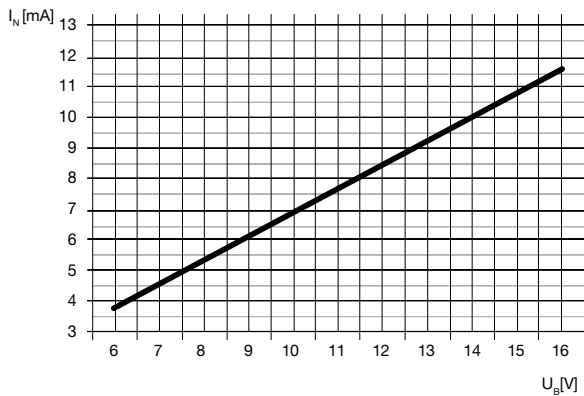

Control current for 24 V – 10 A / 17 A / 30 A variant

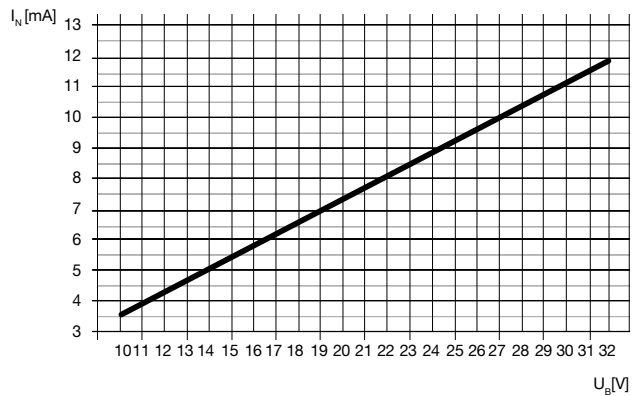

5

Frequency control 10 A

10 A / 12 V variant

Frequency measurement with 100 Hz

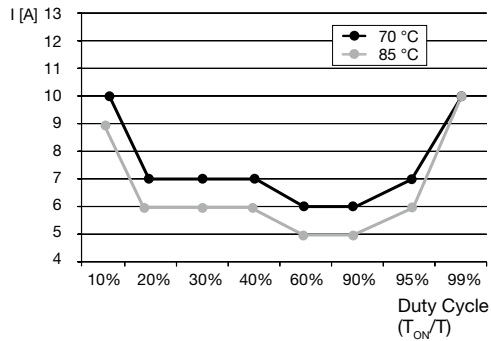

10 A / 24 V variant

Frequency measurement with 50 Hz

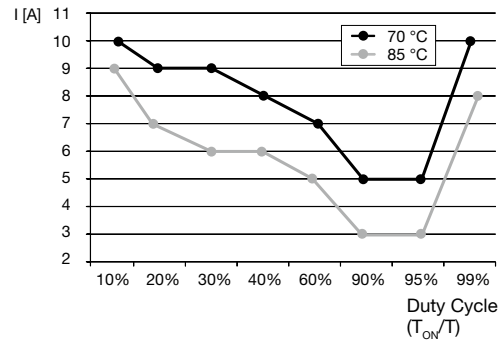

Frequency measurement with 150 Hz

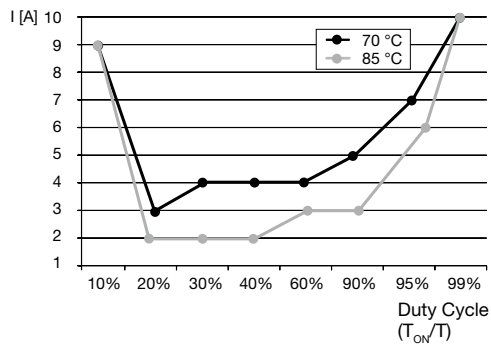

Frequency measurement with 100 Hz

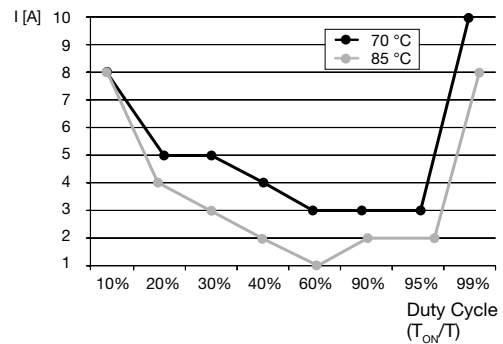

Frequency measurement with 200 Hz

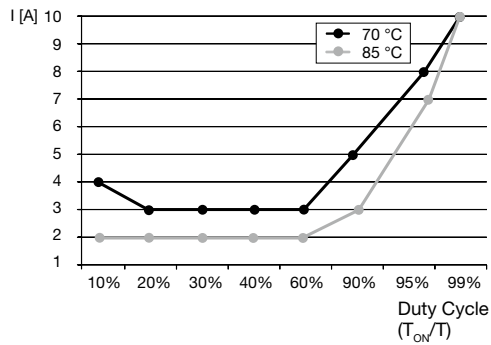

The max. load current depends on the load type. Please contact the manufacturer of the load if the limit values shown above are reached. E-T-A is able to test whether the relay works in the limit range.

Frequency control 17 A / 30 A

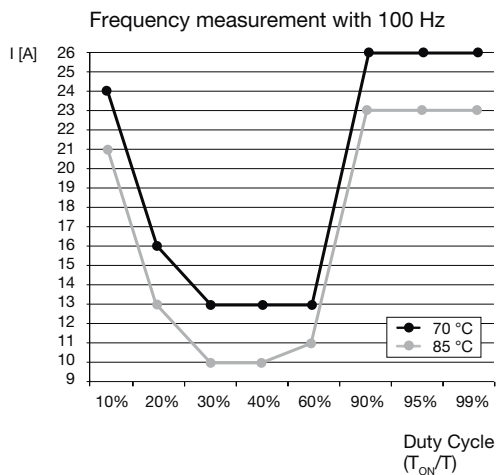
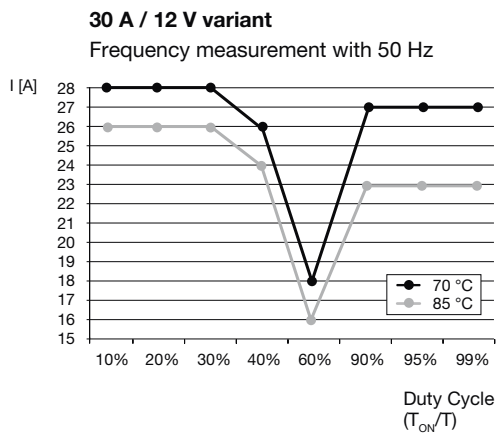
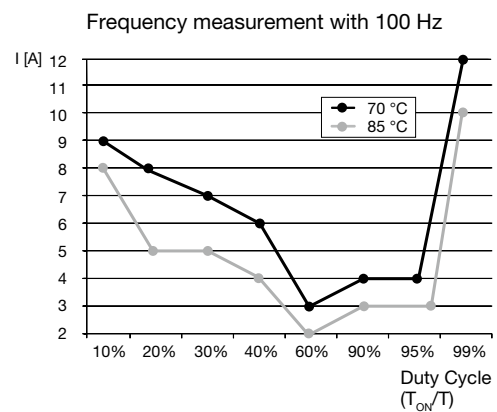
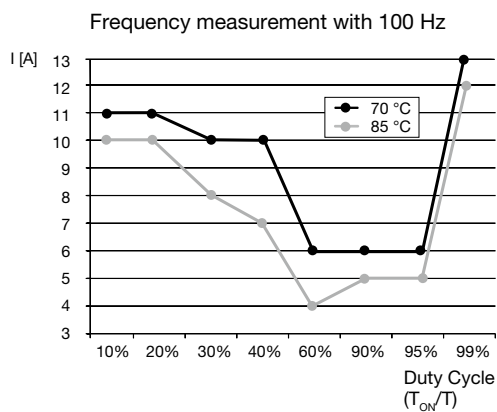
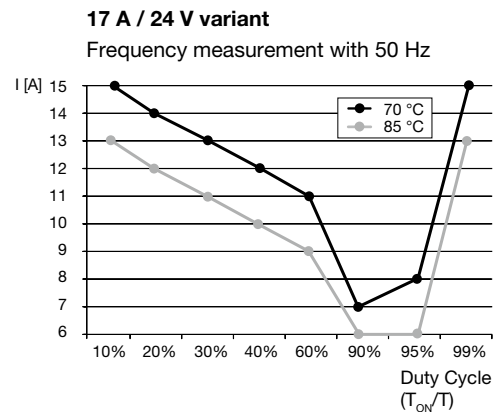
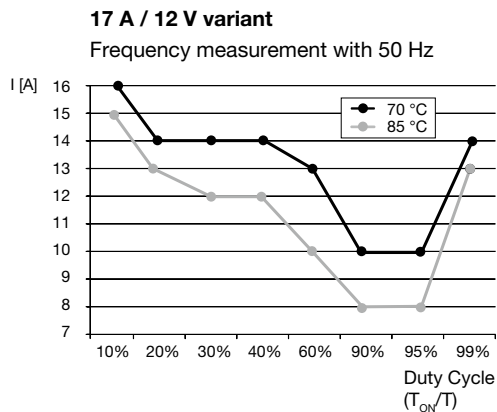

The max. load current depends on the load type. Please contact the manufacturer of the load if the limit values shown above are reached. E-T-A is able to test whether the relay works in the limit range.

5

## Данный компонент на территории Российской Федерации

### Вы можете приобрести в компании MosChip.

Для оперативного оформления запроса Вам необходимо перейти по данной ссылке:

<http://moschip.ru/get-element>

Вы можете разместить у нас заказ для любого Вашего проекта, будь то серийное производство или разработка единичного прибора.

В нашем ассортименте представлены ведущие мировые производители активных и пассивных электронных компонентов.

Нашей специализацией является поставка электронной компонентной базы двойного назначения, продукции таких производителей как XILINX, Intel (ex.ALTERA), Vicor, Microchip, Texas Instruments, Analog Devices, Mini-Circuits, Amphenol, Glenair.

Сотрудничество с глобальными дистрибьюторами электронных компонентов, предоставляет возможность заказывать и получать с международных складов практически любой перечень компонентов в оптимальные для Вас сроки.

На всех этапах разработки и производства наши партнеры могут получить квалифицированную поддержку опытных инженеров.

Система менеджмента качества компании отвечает требованиям в соответствии с ГОСТ Р ИСО 9001, ГОСТ РВ 0015-002 и ЭС РД 009

### Офис по работе с юридическими лицами:

105318, г.Москва, ул.Щербаковская д.3, офис 1107, 1118, ДЦ «Щербаковский»

Телефон: +7 495 668-12-70 (многоканальный)

Факс: +7 495 668-12-70 (доб.304)

E-mail: [info@moschip.ru](mailto:info@moschip.ru)

Skype отдела продаж:

moschip.ru

moschip.ru\_4

moschip.ru\_6

moschip.ru\_9