

HEAVY EQUIPMENT & MATERIAL HANDLING GRIPS

The G3 Universal Grips can be customized for top-of-the-line machines requiring high switch content, or to provide only basic control functions on lower tier units. The OTTO G3 Universal Grips have a modular design and were developed for use with OTTO's standard pushbuttons, rockers, toggles, Hall effect switches and the JH and JHM series Hall effect joystick. Both the Small Universal Grip and the Medium Universal Grip are easily customized with multiple switch configurations, quickly and without tooling charges.

- **Modular design eliminates the need for tooling charges**
- **Compatible with the OTTO JH and JHM series Hall effect Joysticks**
- **Small & medium sizes available**
- **Accommodates a full line of pushbutton, rocker, toggle, HP Hall effect & HPL proportional output series of switches**
- **Various mounting & termination options available**
- **Includes mounting adapter with boot ring**



Small Universal Grip Shown Unpopulated and with Pushbutton and Rocker Switches

Medium Universal Grip Shown with Pushbutton and Rocker Switches

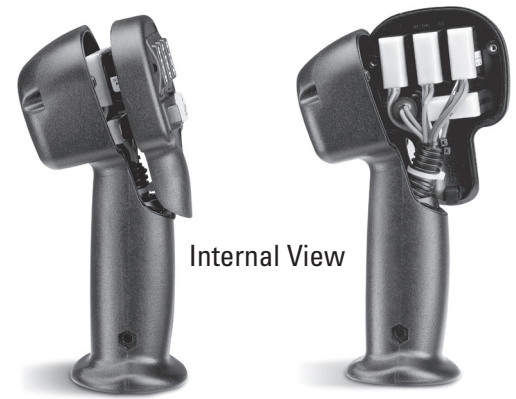
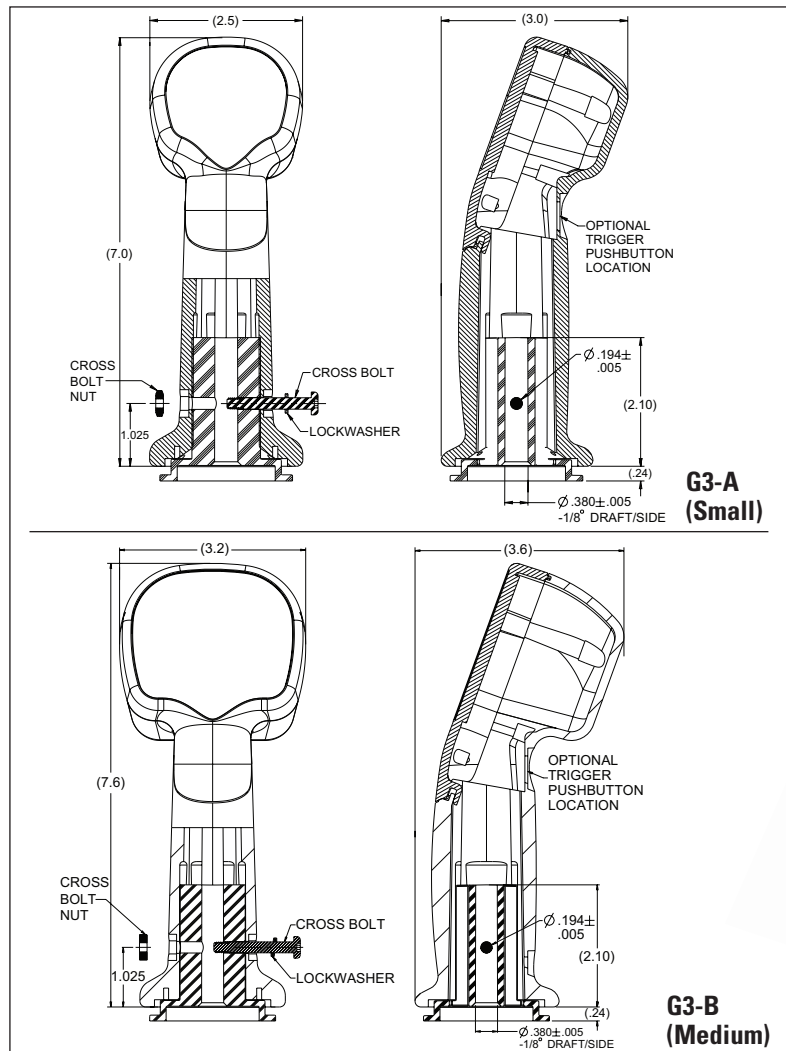

Internal View



Custom Mounting Adapters Available



Custom Terminations Available

MEDIUM UNIVERSAL GRIPS

G3-B PART NUMBER CODE

	G3-B	X	XX	X	X	X	X	X	Part Number Code Continued Below
Configuration	Switches	Trigger Pushbutton in Handle	K1 Rocker #1 Style - Black *	K1 Rocker #2 Style - Black *	K1 Rocker #3 Style - Black *	K1 Rocker #4 Style - Black *			
1. Grip Only	See Configuration Sheet on page 33	1. None 2. Black 3. Red	1. None 2. On-Off 3. (On)-Off 4. On-Off-On 5. (On)-Off-(On)	1. None 2. On-Off 3. (On)-Off 4. On-Off-On 5. (On)-Off-(On)	1. None 2. On-Off 3. (On)-Off 4. On-Off-On 5. (On)-Off-(On)	1. None 2. On-Off 3. (On)-Off 4. On-Off-On 5. (On)-Off-(On)	1. None 2. On-Off 3. (On)-Off 4. On-Off-On 5. (On)-Off-(On)		

* () denotes momentary. On position or momentary position is up or to the right. Contact factory for rocker legends and additional color options.

G3-B PART NUMBER CODE CONTINUED

	Cont.	X	X	X	X	X	X	X	X
HTW #1**	HTW #2**	P9 Button #1 Color	P9 Button #2 Color	P9 Button #3 Color	P9 Button #4 Color	P9 Button #5 Color	P9 Button #6 Color		
1. None 2. Return to Center ¹ 3. Friction ² 4. Return to End ³	1. None 2. Return to Center ¹ 3. Friction ² 4. Return to End ³	N. None 1. Red 2. Black 3. Orange 4. Yellow 5. Green 6. Blue 7. Violet 8. Gray 9. White	N. None 1. Red 2. Black 3. Orange 4. Yellow 5. Green 6. Blue 7. Violet 8. Gray 9. White	N. None 1. Red 2. Black 3. Orange 4. Yellow 5. Green 6. Blue 7. Violet 8. Gray 9. White	N. None 1. Red 2. Black 3. Orange 4. Yellow 5. Green 6. Blue 7. Violet 8. Gray 9. White	N. None 1. Red 2. Black 3. Orange 4. Yellow 5. Green 6. Blue 7. Violet 8. Gray 9. White	N. None 1. Red 2. Black 3. Orange 4. Yellow 5. Green 6. Blue 7. Violet 8. Gray 9. White	N. None 1. Red 2. Black 3. Orange 4. Yellow 5. Green 6. Blue 7. Violet 8. Gray 9. White	

1 = HTW-1A12X22***
2 = HTWF-1A12X22***
3 = HTWE-1A12X22***

** Positive travel is up or to the right. Contact factory for additional options.
***Contact factory for additional options.

STANDARD FACEPLATES

MEDIUM UNIVERSAL GRIPS SWITCH CONFIGURATIONS

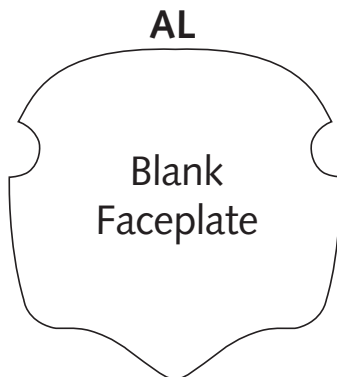
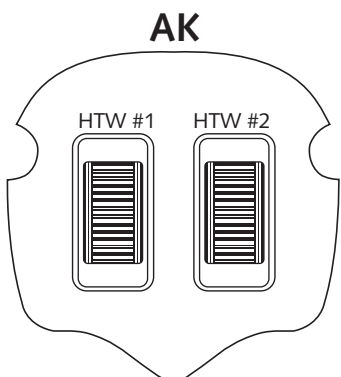
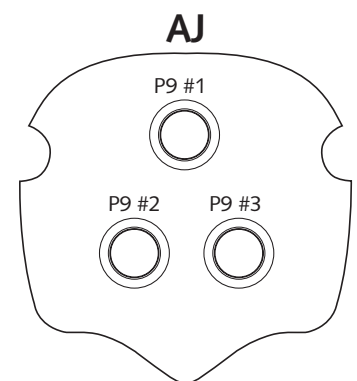
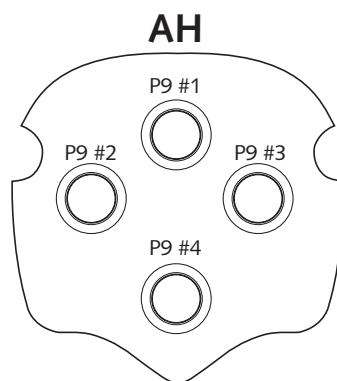
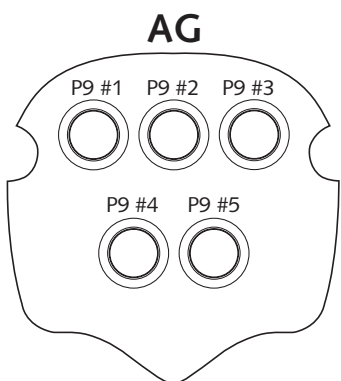
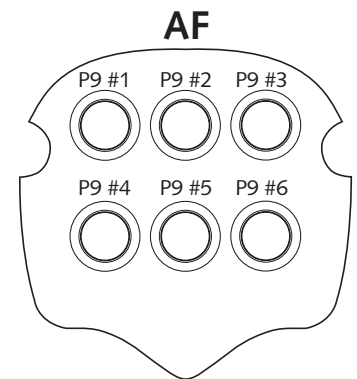
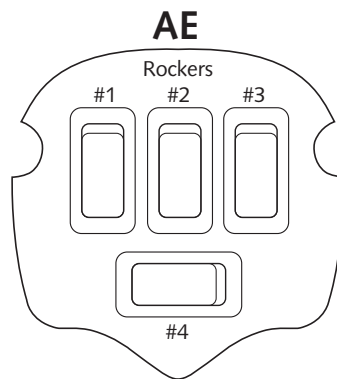
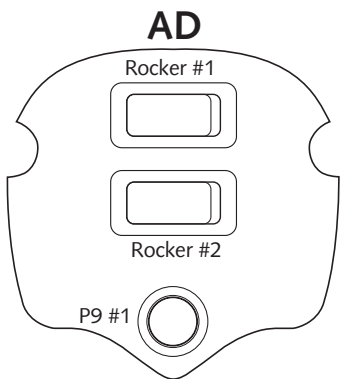
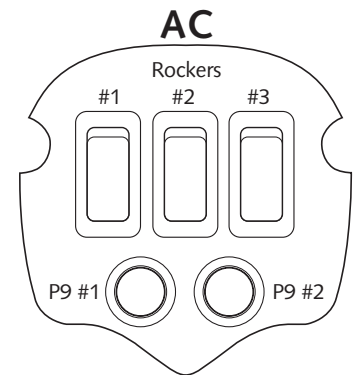
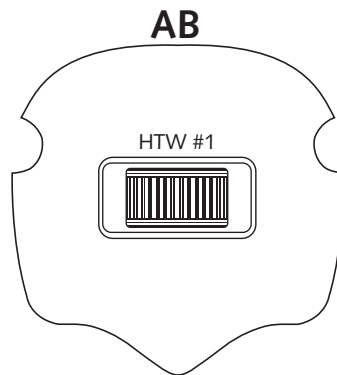
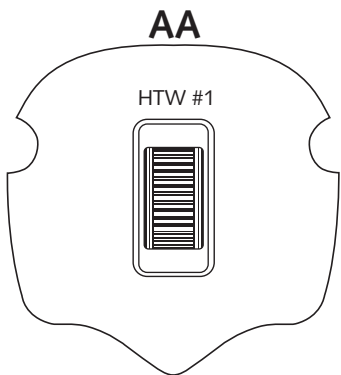

Note: Faceplates and switches are not actual size. Switches are not proportional to the faceplates. Drawings are for configuration reference only.

MEDIUM UNIVERSAL GRIPS SCHEMATICS

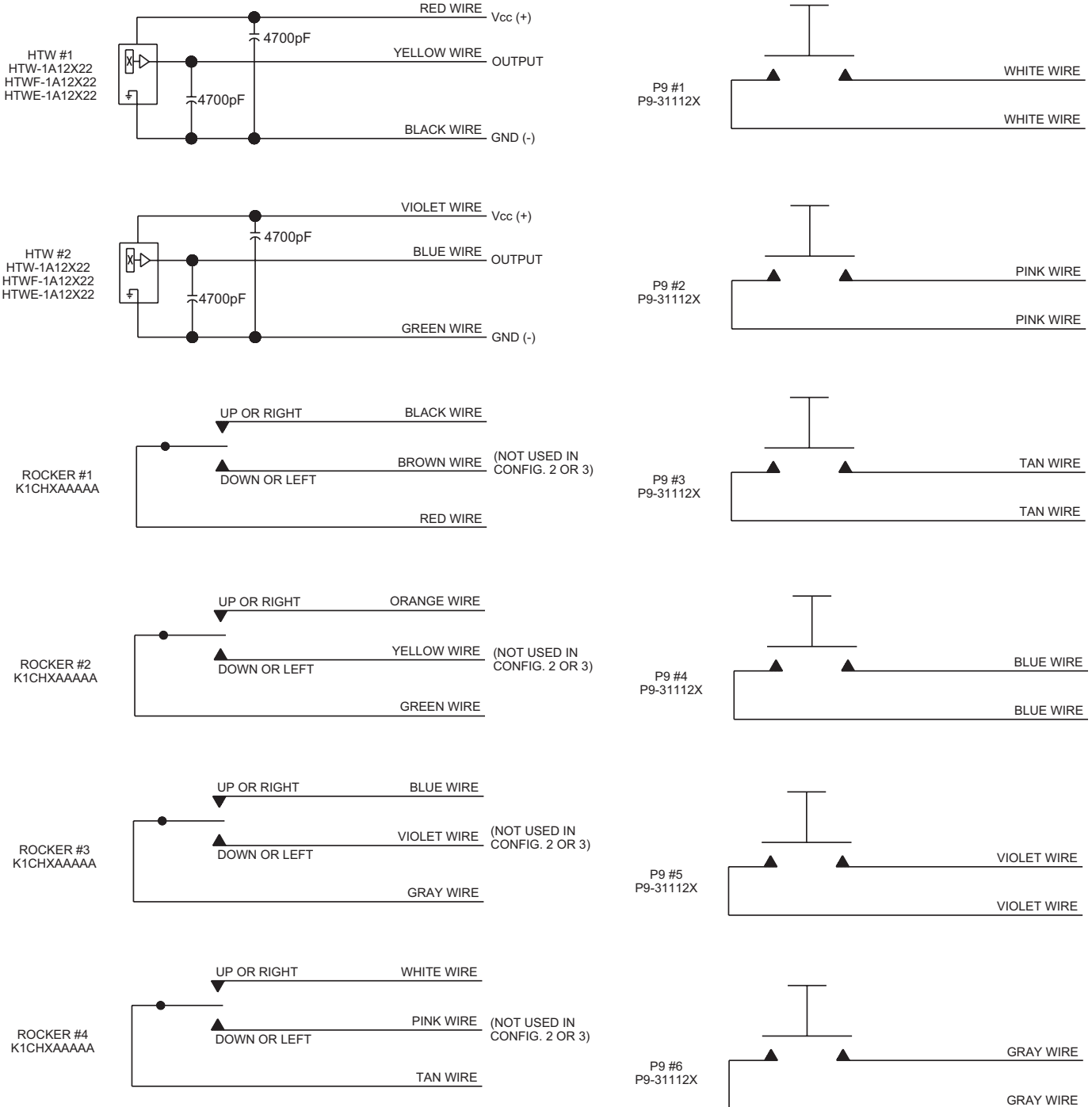

Данный компонент на территории Российской Федерации

Вы можете приобрести в компании MosChip.

Для оперативного оформления запроса Вам необходимо перейти по данной ссылке:

<http://moschip.ru/get-element>

Вы можете разместить у нас заказ для любого Вашего проекта, будь то серийное производство или разработка единичного прибора.

В нашем ассортименте представлены ведущие мировые производители активных и пассивных электронных компонентов.

Нашей специализацией является поставка электронной компонентной базы двойного назначения, продукции таких производителей как XILINX, Intel (ex.ALTERA), Vicor, Microchip, Texas Instruments, Analog Devices, Mini-Circuits, Amphenol, Glenair.

Сотрудничество с глобальными дистрибьюторами электронных компонентов, предоставляет возможность заказывать и получать с международных складов практически любой перечень компонентов в оптимальные для Вас сроки.

На всех этапах разработки и производства наши партнеры могут получить квалифицированную поддержку опытных инженеров.

Система менеджмента качества компании отвечает требованиям в соответствии с ГОСТ Р ИСО 9001, ГОСТ РВ 0015-002 и ЭС РД 009

Офис по работе с юридическими лицами:

105318, г.Москва, ул.Щербаковская д.3, офис 1107, 1118, ДЦ «Щербаковский»

Телефон: +7 495 668-12-70 (многоканальный)

Факс: +7 495 668-12-70 (доб.304)

E-mail: info@moschip.ru

Skype отдела продаж:

moschip.ru

moschip.ru_4

moschip.ru_6

moschip.ru_9