

Alternator voltage regulator

Features

- For air and liquid cooled applications
- Ambient air temperature (thermistor) compensated
- Special default compensation curve with TS-terminal open
- Compensation curve with application specific resistor on TS
- Thermal protection
- Field driver, lamp driver, relay driver, and df (field monitor) short circuit protected
- Load response control
- Single phase autostart

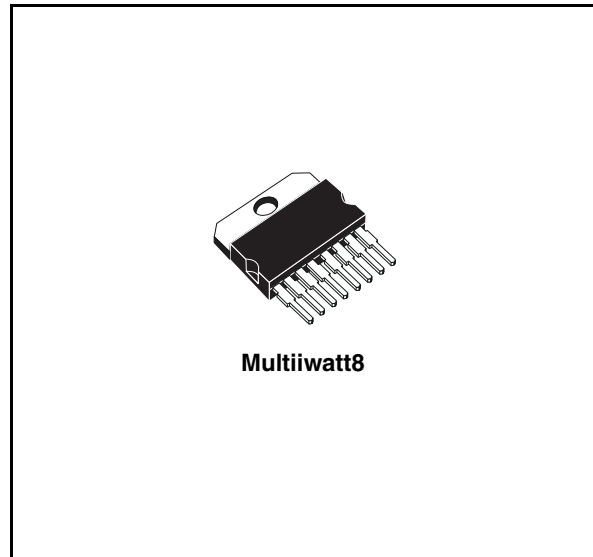

Description

The L9484 is a monolithic multifunction alternator voltage regulator intended for use in automotive charging applications.

L9484 regulates the output of an automotive generator by controlling the field winding current by means of a variable frequency PWM high side driver.

Table 1. Device summary

Order code	Package	Packing
L9484	Multiwatt8	Tube

Contents

1	Pin description	3
2	Electrical specification	4
2.1	Absolute maximum ratings	4
2.2	Thermal data	4
2.3	Electrical characteristics	4
2.4	Diagnostic	7
2.5	Fault indication	7
2.6	Regulation features	7
3	Package information	9
4	Revision history	10

1 Pin description

Table 2. Pin description

N #	Pin	Description
1	V _{GO}	Generator output – voltage sense and power supply to ASVR
2	F+	Field driver - high side drive output
3	G	Ground for ASVR (must be connected for ground for ASVR)
4	TS	Thermistor sense terminal
5	Gnd	Internally connected to the tab or slug in MW-8. Shall not be used for ASVR ground, nor voltage applied to pin 5 to cause ≥ 50mV pin 5 to pin 3. May be unconnected or externally connected to pin 3.
6	DF	Inverted field monitor output
7	L	Lamp - low side driver; relay - high side driver
8	P	Phase sense input

Figure 1. Pin connection (top view)

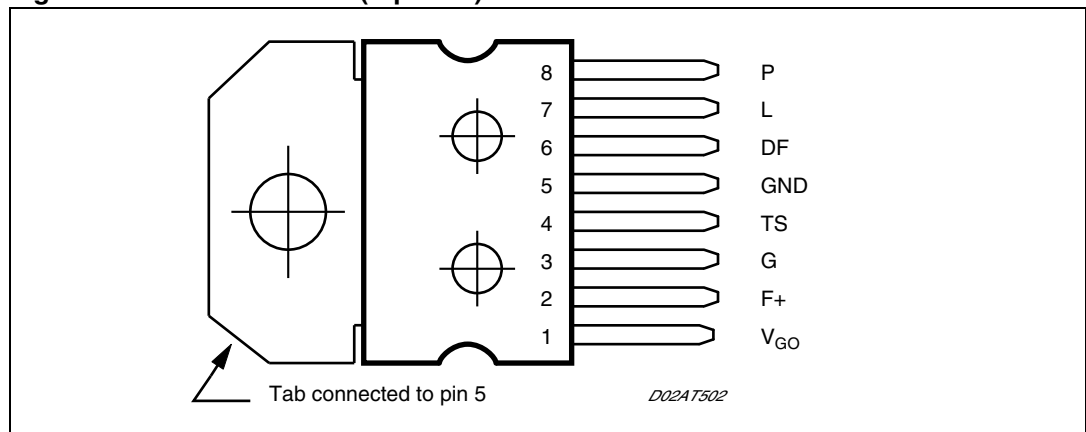

2 Electrical specification

2.1 Absolute maximum ratings

Table 3. Absolute maximum ratings

Symbol	Parameter	Value	Unit
I_o	Output current capability	Internally limited	A
P_{tot}	Power dissipation	6	W
	Short circuit protected	All terminal, to VGO and ground	

2.2 Thermal data

Table 4. Thermal data

Symbol	Parameter	Value	Unit
T_j	Junction temperature	-40 to +150	°C
T_{stg}	Storage temperature	-50 to +150	°C
T_{sd}	Thermal shut-down	175 ± 15	°C
$R_{th\ j-case}$	Thermal resistance junction to case	1.5	°C/W

2.3 Electrical characteristics

Table 5. Electrical characteristics

($T_{case} = -35^{\circ}\text{C}$ to $+150^{\circ}\text{C}$ continuous unless otherwise specified)

Symbol	Parameter	Test condition	Min.	Typ.	Max.	Unit
V_{OS}	Operating supply voltage	$T_{case} = +25^{\circ}\text{C}$ to $+150^{\circ}\text{C}$	8		V_{ov}	V
V_{OS}	Operating supply voltage	$T_{case} = -40^{\circ}\text{C}$ to $+25^{\circ}\text{C}$	10		V_{ov}	V
I_{SB}	Stand-by current	$V_{GO} = 12.6\text{V}$; $T_{case} = 25^{\circ}\text{C}$; $10\text{k}\Omega$ V_{GO} to TS; F+, G & tab (slug) grounded; L, DF, & P unconnected; regulator not activated.			300	μA
V_{SP}	Regulator set-point	$10\text{k}\Omega$ between V_{GO} and TS	Curve shown in Figure 3			
V_{SP}	Regulator set-point	NTC thermistor with $R_{25^{\circ}\text{C}} = 10\text{k}\Omega$; $T_j = 90^{\circ}\text{C}$	Curves shown in Figure 4 (with MURATA NTC NTH4G39A1)			
V_{NB}	Generator output, no battery	No battery, $I_{OUT} = 2\text{A}$ to 50% max. load	$V_{SP} - 2$		$V_{SP} + 2$	V
T_C	Thermal compensation	voltage @ V_{GO}	Curves shown in Figure 3 and Figure 4			

Table 5. Electrical characteristics (continued)
 ($T_{case} = -35^{\circ}C$ to $+150^{\circ}C$ continuous unless otherwise specified)

Symbol	Parameter	Test condition	Min.	Typ.	Max.	Unit
V_{LR}	Load regulation	6500 grpm, 10% to 95% load			300	mV
V_{SR}	Speed regulation	15A load, 2000 to 20,000 grpm			100	mV
V_{F-ON}	Output saturation voltage	$I_F = 6A, V_{GO} = 14.0V, T_{case} = 25^{\circ}C$			750	mV
V_{F-ON}	Output saturation voltage	$I_F = 5A, V_{GO} = 13.5V, T_{case} = 125^{\circ}C$			850	mV
I_{F-LIM}	Field limit current ⁽¹⁾	Current F+ Terminal to Gnd. @ $T_{case} \leq 25^{\circ}C$	9.0			A
I_{F-LIM}	Field limit current ⁽¹⁾	Current F+ Terminal to Gnd. @ $T_{case} = +150^{\circ}C$	6.0			A
I_{G-MIN}	Min. generator current load	Current measured @ generator output	0.5			A
V_{D-F}	Field discharge diode	$I_F = 6A, T_{case} = 25^{\circ}C$			1.85	V
I_{D-R}	Diode reverse current	$V_R = 20V$			1	mA
F_{OSC}	oscillation frequency	During LRC operation	340	400	460	Hz
V_{DF}	DF saturation voltage	$I_{DF} \leq 10mA$			0.8	V
I_{DF-LK}	DF output leakage current	$V_{DF} < 25V$			10	μA
F_{TURBO}	Internal clock frequency	$V_{DF} = 32 - 35V; \text{ thru } 2.2k\Omega$		4X		Hz
F_{TURBO}	IRD, SS, LRC rate	$V_{DF} = 32 - 35V; \text{ thru } 2.2k\Omega$		$\div 16$		

1. The Field Drive capability shall not decrease as a function of temperature between $25^{\circ}C$ and $150^{\circ}C$, at a rate faster than $-0.024A/^{\circ}C$ (for example, Field Drive shall be capable of $\geq 7.2A$ at $100^{\circ}C$).

Figure 2. Typical application schematic

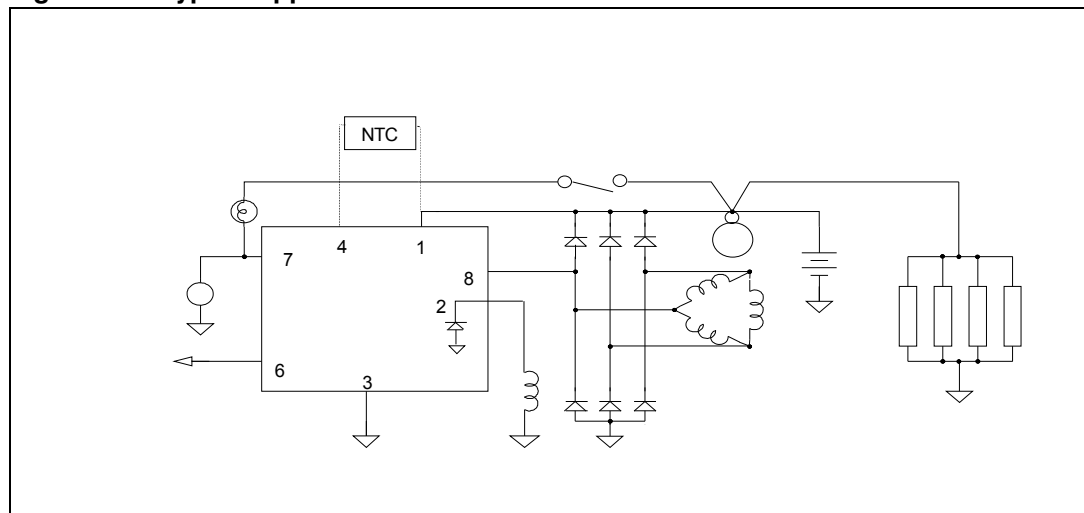

Figure 3. Set-point voltage vs. mounting tab temperature (10kΩ between V_{GO} & TS)

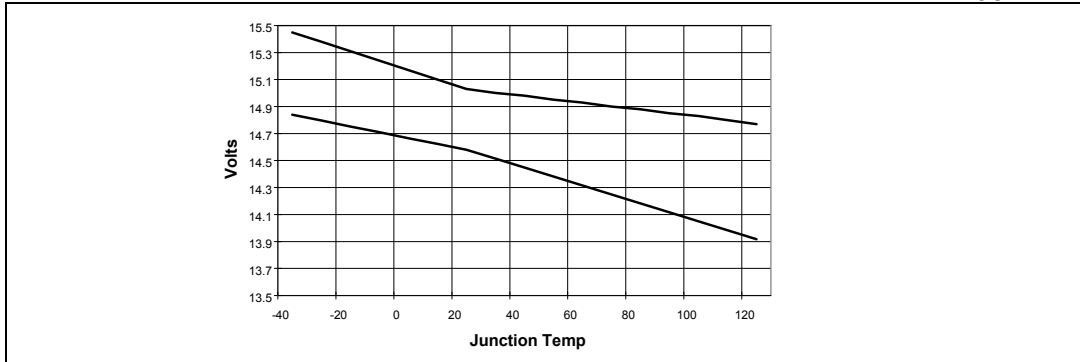

Figure 4. Set-point voltage vs. thermistor temperature, T_j = 90°C (not guaranteed by testing, depending on NTC characteristics)

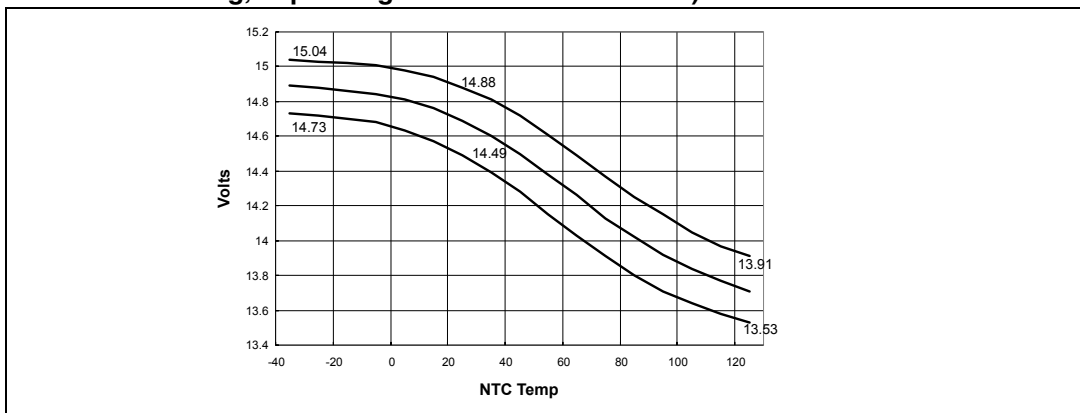
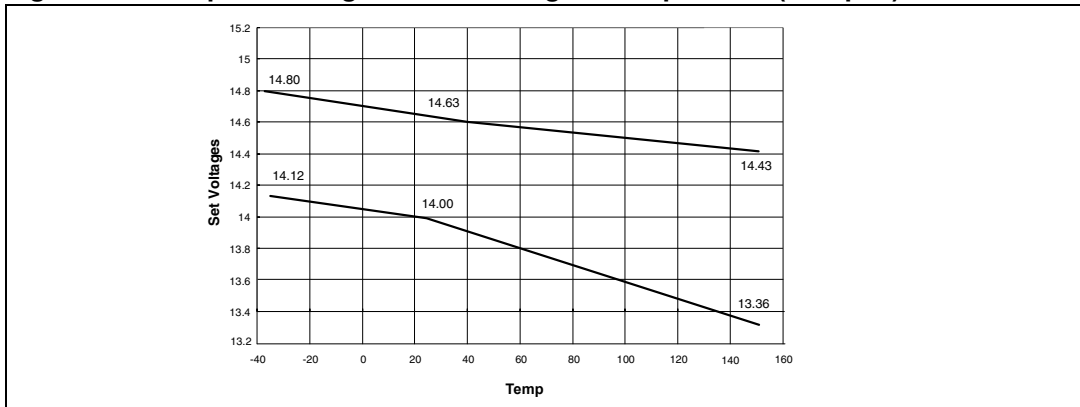

Figure 5. Set-point voltages vs. mounting tab temperature (TS-open)



2.4 Diagnostic

Table 6. Diagnostic
($T_{case} = -35^{\circ}C$ to $+150^{\circ}C$ unless otherwise specified)

Symbol	Parameter	Conditions	Min.	Typ.	Max.	Units
V_{OV}	Over-voltage		$V_{SP} + 1$	$V_{SP} + 1.3$	$V_{SP} + 2$	V
V_{L-SAT}	Lamp ON saturation voltage	$I_L = 0.5A$ (sunked by ASVR)	$>V_{L-ACT}$	1.33	1.45	V
$V_{L-SAT-BO}$	Lamp ON voltage ⁽¹⁾	$I_L < 0.5A$, VGO = open; $T_{case} = -35^{\circ}C$ to $85^{\circ}C$		3.8	5	V
V_{L-RLY}	Lamp OFF (relay drive) saturation voltage (vs. B+)	$I_L = 750mA$ (sourced by ASVR) ⁽²⁾ $T_{case} < 125C$			1.85	V
T_{DELAY}	Fault indication delay time	Delay before lamp ON	0.9	1.1	1.3	s

1. This condition can happen when the connection between the battery and VGO or the output terminal of the generator is broken. The 1.1 second delay is not required, and current is sunked by ASVR.
2. When no fault is detected the Lamp terminal is pulled up by ASVR.

2.5 Fault indication

Table 7. Fault indication table

Conditions	T_{Delay} ?
Initial KEY-ON Bulb and wiring check (lamp ON for 1 sec \pm 15% after initial KEY-ON)	No
$V_{GO} > V_{OV}$	Yes
$V_P < V_{P-F}$ AND $V_{GO} < V_{SP}$	Yes
$F_P < F_{P-TR}$ @ V_{P-TR}	Yes
No connection between battery and V_{GO}	No
At start: lamp ON until $F_P > F_{P-IR}$ AND $V_P > V_{P-F}$ i.e. until V_P reaches 8V.	No

2.6 Regulation features

Table 8. Regulation features

Symbol	Parameter	Conditions	Min.	Typ.	Max.	Unit
V_{L-PD}	L terminal regulator activate threshold	VGO=12.6V	0.8	1	1.15	V
I_{L-PD}	L terminal pull down current	$V_L = V_{L-ACT}$ VGO=12.6V	0.09		0.78	mA
V_{P-IR}	Initiate regulation phase voltage threshold	Regulator activated	1.1	1.3	1.5	V
V_{P-TR}	Terminate regulation phase voltage threshold	Regulator activated	1.1	1.3	1.5	V

Table 8. Regulation features (continued)

Symbol	Parameter	Conditions	Min.	Typ.	Max.	Unit
V_{P-F}	Phase input voltage low fault threshold		7.0	8	9.0	V
I_P	Phase terminal current sink	$V_P > 1.5V$ and $< 12.6V$ $V_{GO} = 12.6V$	0.3		3.5	mA
F_{P-IR}	Initiate regulation phase frequency		123	145	167	Hz
F_{P-TR}	Terminate regulation phase frequency		59	72	86	Hz
IRD	Initiate regulation delay	Regulator activated, V_{P-IR} AND F_{P-IR} conditions met first time.	1.7	2	2.3	s
FSDC	Field strobe duty cycle	Regulator activated and (regulation terminated or regulation not initiated)	16	18.75	22	%
LRC	Load response control rate	Field drive duty cycle increase	34	40	46	%/s
F_{P-LRC}	LRC transition frequency	LRC enabled if $F_P < F_{P-LRC}$	255	300	345	Hz
SS	Soft-start	LRC enabled until V_{SP} reached regardless other conditions	34	40	46	%/s

3 Package information

In order to meet environmental requirements, ST (also) offers these devices in ECOPACK[®] packages. ECOPACK[®] packages are lead-free. The category of second Level Interconnect is marked on the package and on the inner box label, in compliance with JEDEC Standard JESD97. The maximum ratings related to soldering conditions are also marked on the inner box label.

ECOPACK is an ST trademark. ECOPACK specifications are available at: www.st.com.

Figure 6. Multiwatt8 mechanical data and package dimensions

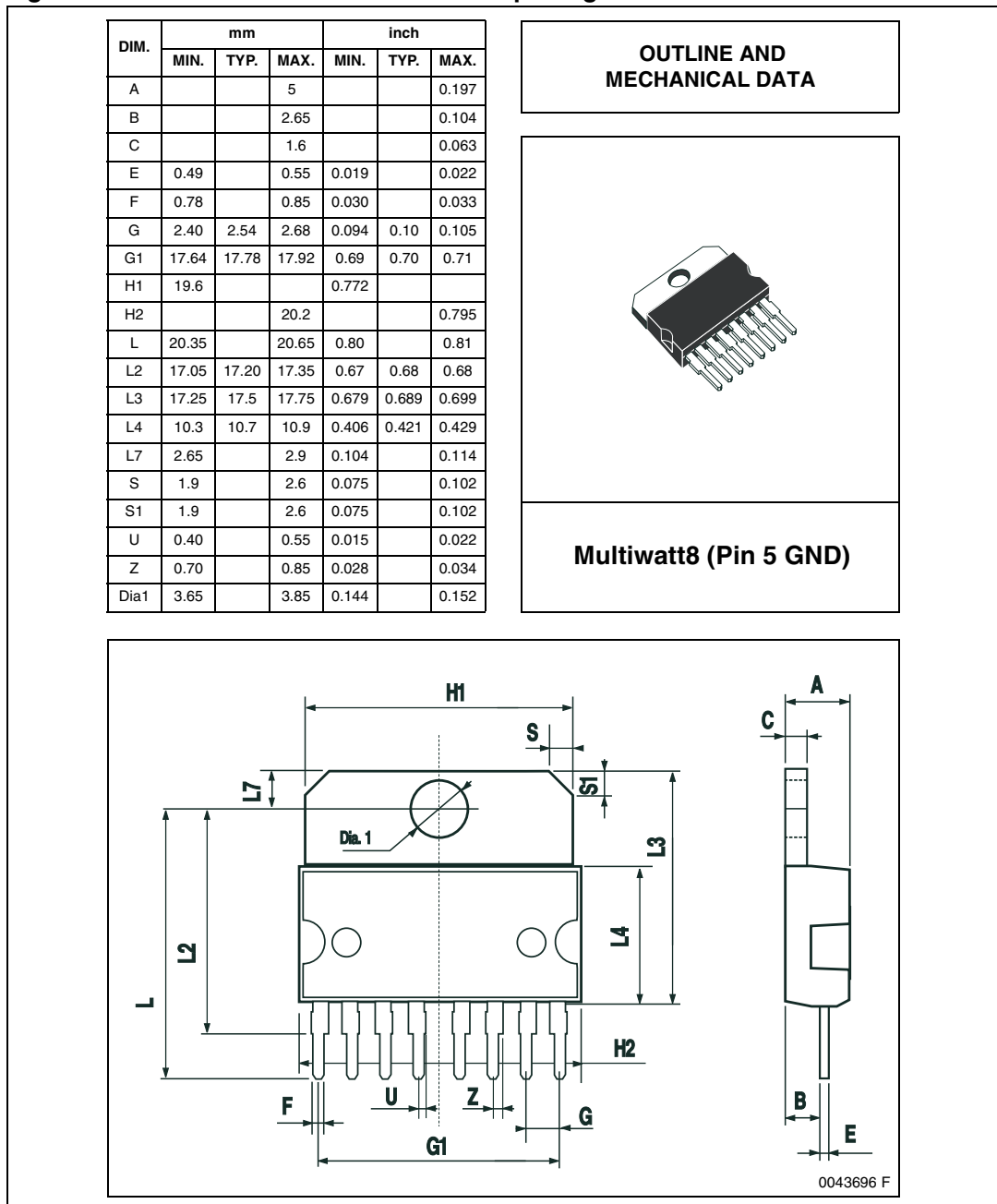

4 Revision history

Table 9. Document revision history

Date	Revision	Changes
15-Feb-2003	1	Initial release.
09-Sept-2004	2	Update
18-Nov-2008	3	Document reformatted. Document promoted from “product preview” to “datasheet”. Added Table 1: Device summary on page 1 . Added ECOPACK text in Section 3: Package information .
19-Sep-2013	4	Updated Disclaimer.

Please Read Carefully:

Information in this document is provided solely in connection with ST products. STMicroelectronics NV and its subsidiaries ("ST") reserve the right to make changes, corrections, modifications or improvements, to this document, and the products and services described herein at any time, without notice.

All ST products are sold pursuant to ST's terms and conditions of sale.

Purchasers are solely responsible for the choice, selection and use of the ST products and services described herein, and ST assumes no liability whatsoever relating to the choice, selection or use of the ST products and services described herein.

No license, express or implied, by estoppel or otherwise, to any intellectual property rights is granted under this document. If any part of this document refers to any third party products or services it shall not be deemed a license grant by ST for the use of such third party products or services, or any intellectual property contained therein or considered as a warranty covering the use in any manner whatsoever of such third party products or services or any intellectual property contained therein.

UNLESS OTHERWISE SET FORTH IN ST'S TERMS AND CONDITIONS OF SALE ST DISCLAIMS ANY EXPRESS OR IMPLIED WARRANTY WITH RESPECT TO THE USE AND/OR SALE OF ST PRODUCTS INCLUDING WITHOUT LIMITATION IMPLIED WARRANTIES OF MERCHANTABILITY, FITNESS FOR A PARTICULAR PURPOSE (AND THEIR EQUIVALENTS UNDER THE LAWS OF ANY JURISDICTION), OR INFRINGEMENT OF ANY PATENT, COPYRIGHT OR OTHER INTELLECTUAL PROPERTY RIGHT.

ST PRODUCTS ARE NOT DESIGNED OR AUTHORIZED FOR USE IN: (A) SAFETY CRITICAL APPLICATIONS SUCH AS LIFE SUPPORTING, ACTIVE IMPLANTED DEVICES OR SYSTEMS WITH PRODUCT FUNCTIONAL SAFETY REQUIREMENTS; (B) AERONAUTIC APPLICATIONS; (C) AUTOMOTIVE APPLICATIONS OR ENVIRONMENTS, AND/OR (D) AEROSPACE APPLICATIONS OR ENVIRONMENTS. WHERE ST PRODUCTS ARE NOT DESIGNED FOR SUCH USE, THE PURCHASER SHALL USE PRODUCTS AT PURCHASER'S SOLE RISK, EVEN IF ST HAS BEEN INFORMED IN WRITING OF SUCH USAGE, UNLESS A PRODUCT IS EXPRESSLY DESIGNATED BY ST AS BEING INTENDED FOR "AUTOMOTIVE, AUTOMOTIVE SAFETY OR MEDICAL" INDUSTRY DOMAINS ACCORDING TO ST PRODUCT DESIGN SPECIFICATIONS. PRODUCTS FORMALLY ESCC, QML OR JAN QUALIFIED ARE DEEMED SUITABLE FOR USE IN AEROSPACE BY THE CORRESPONDING GOVERNMENTAL AGENCY.

Resale of ST products with provisions different from the statements and/or technical features set forth in this document shall immediately void any warranty granted by ST for the ST product or service described herein and shall not create or extend in any manner whatsoever, any liability of ST.

ST and the ST logo are trademarks or registered trademarks of ST in various countries.

Information in this document supersedes and replaces all information previously supplied.

The ST logo is a registered trademark of STMicroelectronics. All other names are the property of their respective owners.

© 2013 STMicroelectronics - All rights reserved

STMicroelectronics group of companies

Australia - Belgium - Brazil - Canada - China - Czech Republic - Finland - France - Germany - Hong Kong - India - Israel - Italy - Japan - Malaysia - Malta - Morocco - Philippines - Singapore - Spain - Sweden - Switzerland - United Kingdom - United States of America

www.st.com

Данный компонент на территории Российской Федерации

Вы можете приобрести в компании MosChip.

Для оперативного оформления запроса Вам необходимо перейти по данной ссылке:

<http://moschip.ru/get-element>

Вы можете разместить у нас заказ для любого Вашего проекта, будь то серийное производство или разработка единичного прибора.

В нашем ассортименте представлены ведущие мировые производители активных и пассивных электронных компонентов.

Нашей специализацией является поставка электронной компонентной базы двойного назначения, продукции таких производителей как XILINX, Intel (ex.ALTERA), Vicor, Microchip, Texas Instruments, Analog Devices, Mini-Circuits, Amphenol, Glenair.

Сотрудничество с глобальными дистрибьюторами электронных компонентов, предоставляет возможность заказывать и получать с международных складов практически любой перечень компонентов в оптимальные для Вас сроки.

На всех этапах разработки и производства наши партнеры могут получить квалифицированную поддержку опытных инженеров.

Система менеджмента качества компании отвечает требованиям в соответствии с ГОСТ Р ИСО 9001, ГОСТ РВ 0015-002 и ЭС РД 009

Офис по работе с юридическими лицами:

105318, г.Москва, ул.Щербаковская д.3, офис 1107, 1118, ДЦ «Щербаковский»

Телефон: +7 495 668-12-70 (многоканальный)

Факс: +7 495 668-12-70 (доб.304)

E-mail: info@moschip.ru

Skype отдела продаж:

moschip.ru

moschip.ru_4

moschip.ru_6

moschip.ru_9