

3M™ Shrinkable Tubing for Bus Bar BBI-A Series 5-35kV

Data Sheet

September 2013



Description 3M™ Heat Shrinkable Tubing for Bus Bar BBI-A Series is designed for insulating rectangular, square and round bus bar rated from 5 kV through 35 kV. It will also cover and insulate inline bolted connections of rectangular bus bars. The tubing meets the requirements of ANSI/IEEE Standard C37.20. The standard tubing lengths are 20 feet (6,1 m) and 50 feet (15,2m).

3M BBI-A Tubing is made of a specially formulated cross-linked polyolefin. The tubing is colored orange-red. The material has high resistance to splitting, good solvent resistance and excellent tracking resistance properties. The tubing shrinks easily with industry standard methods, forming an aesthetically appealing insulation cover.

Features Specially formulated cross-linked polyolefin

- Excellent physical properties
- Excellent dielectric strength
- Excellent tracking resistance
- Excellent chemical resistance
- Good thermal endurance
- Flame retardant; self extinguishing
- Flexible; conforms to bends

Heat shrinkable design

- Each tube fits a range of bus bar sizes and voltage ratings
- Tight fit provides good heat dissipation

3M™ Heat Shrinkable Tubing for Bus Bar BBI-A Series 5-35 kV

- Applications** For insulating electrical bus bars per ANSI/IEEE Standard C37.20:
- For 5, 8, 15, 25 and 35 kV voltage ratings
 - For rectangular, square and round bus bars
 - For inline bolted connections of rectangular bus bars
 - For copper or aluminum bus bars
 - For use in metal-clad switchgear
 - For use on metal-enclosed bus bar
 - For use with substation switchgear
-

Engineering/ Architectural Specifications All straight sections of bus bar, and inline connections of rectangular bus bars, shall be insulated in accordance with the instructions included with the 3M Heat Shrinkable Tubing for Bus Bar BBI-A Series. This coverage shall include all copper and aluminum, rectangular, square and round bus bar's rated at 5, 8, 15, 25 and 35 kV.

Product Specifications All straight sections of bus bar shall be insulated with 110°C (230°F) rated heat shrink tubing which meets the requirements of ANSI/IEEE C37.20. The tubing shall be made of specially formulated, cross-linked polyolefin, orange-red in color. The tubing shall be rated for the same voltage-rating as the bus bar, up to 35 kV. The insulation shall be designed for use on rectangular, square and round bus bars, and it must be designed to cover and insulate inline bolted connections of rectangular bus bars. The product must be packaged with complete installation instructions.

Performance Tests **Dielectric Withstand Tests (ANSI/IEEE C37.20):**
Tests were performed on BBI Series Tubing installed on rectangular bus bar, on both straight sections and inline bolted connections. The 2 and 3 in. (51 and 76 mm) bars were 10 ft. (3,05 m) long, and all other bars were 12 ft. (3,66 m).

Power Frequency and Impulse Withstand Tests:

The samples were inserted through a grounded 3 ft. (0.9 m) long duct and positioned to required air gap clearance from one duct wall.

Test for Bus Bar Insulation:

The samples were wrapped with a half-lapped layer of 3M Scotch_ 24 Electrical Shielding Tape to establish a ground plane in contact with the BBI insulation.

Corona Tests (ANSI/IEEE 454):

Corona (partial discharge) testing was performed on BBI insulated bus bar which was inserted through a grounded 3ft. (0.9 m) long duct. The bar was positioned to the required air gap clearance from one duct wall. The test results suggest that the air gap between the bar and duct is so large in relationship to the air gap between the bar and insulation, that no corona condition exists in the normal testing range up to 38 kV.

3M™ Heat Shrinkable Tubing for Bus Bar BBI-A Series 5-35 kV

Typical Physical and Electrical Properties	
* All values are averages, based on several determinations, and are not intended for specification purposes	
Electrical Properties	
Test Method	Typical Value*
Dielectric Constant (ASTM D-150)	3.5
Dielectric Strength (70 mils) (ASTM D-149)	550 V/mil (22 MV/m)
Volume Resistivity (ASTM D-257) (MIL-I-23053/15A)	1.4×10^3
Track Resistance (7 hrs.) (ASTM D-2303) (ANSI/IEEE C37.20)	1 in. @ 2.5 kV (25mm @ 2.5 kV)
Physical Properties	
Test Method	Typical Value*
Tensile Strength (ASTM D-257) (MIL-I-23053/15A)	2200 psi (15 MPa)
Ultimate Elongation (ASTM D-638) (MIL-I-23053/15A)	575%
Water Absorption 7 days @ 23°C (73°F) (MIL-I-23053/15A)	0.3%
Corrosion (Copper) 16 hrs. @ 120°C (248°F) (MIL-I-23053/15A)	Pass
Fluid Resistance 24 hrs. immersed (MIL-I-23053/15A)	Tensile = 810–2400 psi (5.6–16.5 MPa) Dielectric Str. = 287–451 V/mil (11.3–17.8 MV/m)
Thermal Properties	
Test Method	Typical Value*
Flammability (ANSI/EEE C37.20)	Pass
Thermal Endurance (ANSI/EEE 1) (IEC 216)	110° C (230° F)
Accelerated Aging 7 days @ 175° C (347° F) (MIL-I-23053/15A)	Tensile = 1430 psi (10 MPa) Elongation = 400%
Heat Shock 4 hrs @ 225° C (437° F) (MIL-I-23053/15A)	Pass
Low Temperature Flexibility 4 hrs @ -55° C (-67° F) (MIL-I-23053/15A)	Pass

3M™ Heat Shrinkable Tubing for Bus Bar BBI-A Series 5-35 kV

Fluid Resistance (MIL-I-23053/15A)

Immersion at 23° C (73° F) for 24 hours

Typical Physical Properties after Immersion					
Fluid	Fluid Absorption (% by wt.)	Tensile Strength (ps) (MPa)	Elongation at Break (%)	Dielectric Strength (V/mil @ 0.150 in.) (MV/m)	Results
Specification Requirement		>750 (>5,2)		>200 (>7,9)	
Deicing fluid (Mil-A-8243)	0.0	2330 (16,1)	600	333 (13,1)	Pass
Hydraulic fluid (Mil-H-5606)	2.8	1920 (13,2)	550	392 (15,4)	Pass
Lube oil (Mil-L-7808)	0.8	2330 (16,1)	515	404 (15,90)	Pass
Lubricating oil (Mil-T-5624)	0.3	2365 (16,3)	515	451 (17,8)	Pass
Jet fuel, JP-4 (Mil-T-5624)	7.4	1380 (9,5)	515	349 (13,7)	Pass
5% Salt water	0.1	2400 (16,5)	525	436 (17,2)	Pass
30% Ammonia solution	0.4	2175 (15,0)	600	403 (15,9)	Pass
Noalox Joint Compound	0.4	2180 (15,0)	515	439 (17,3)	Pass
Contact cleaner (3M #1607)	42.0	830 (5,70)	385	287 (11,03)	Pass
Black enamel Paint	23.1	810 (5,6)	350	366 (14,4)	Pass
Acetone	4.2	1550 (10,7)	510	339 (13,3)	Pass
Methylene Chloride	37.9	900 (6,2)	340	313 (12,3)	Pass

3M™ Heat Shrinkable Tubing for Bus Bar BBI-A Series 5-35 kV

Test Description	Rated Maximum Voltage (kV)	ANSI/IEEE C37.20 REQUIREMENT (Kv)	Typical Maximum results (kV)
Power Frequency 1 Minute Withstanding (Duct application)	8.25	26	> 50 (@ 2.5")
	15.50	50	> 50 (@ 2.5")
	25.80	60	> 60 (@ 3.5")
	38.00	80	> 80 (@ 5.5")
Bus Bar Insulation 1 Minute Withstand (shielding tape application)	8.25	8.25	20
	15.50	15.50	20
	25.80	25.80	35
	38.00	38.00	50
Impulse Withstand (1.2 x 50 us wave)	8.25	75	±125 (@ 2.5")
	15.50	110	±125 (@ 2.5")
	25.80	125	±130 (@ 3.5")
	38.00	150	±165 (@ 5.5")



Typical Corona Values			
Rated Maximum Voltage kV	Air Gap (to duct) (in.)	Typical Corona Starting Voltage (CSV) (kV @ > 3pc)	Typical Corona Extinction Voltage (CSV) (kV @ > 3pc)
8.2	2.5	40	38
15.50	2.5	40	38
25.80	3.5	45	42
38.00	5.5	45	42

3M™ Heat Shrinkable Tubing for Bus Bar BBI-A Series 5-35 kV

3M™ Heat Shrinkable Tubing for Bus Bar BBI-A can be used on bus bar rated up to 110°C(230°F), for 5, 8, 15, 25 and 35 kV voltage classes.

Selection Charts for Straight Bus Bar Standard lengths = 20ft. (6.1mm) and 50ft. (15.2mm)



5, 8 and 15 kV Bus Bar Size Ranges				
Product Number	Bar Circumference (A)			
		Rectangular*	Square*	Round
BBI-3A	3.28 – 5.57 in. (83 – 141 mm)	1 1/2 x 1/4 – 2 1/2 x 1/2 in. (38 x 6 – 64 x 13 mm)	1 x 1 – 1 1/2 x 1 1/2 in. (25 x 25 – 38 x 38 mm)	1 1/8 – 1 3/4 in. (25 – 44 mm)
BBI-4A	5.43 – 8.86 in. (138 – 225 mm)	2 1/2 x 3/8 – 4 x 3/4 in. (64 x 10 – 102 x 19 mm)	2 x 2 in. (51 – 51 mm)	1 3/4 – 2 3/4 in. (44 – 70 mm)
BBI-5A	6.67 – 10.86 in. (169 – 276 mm)	3 x 5/8 – 5 x 3/4 in. (76 x 16 – 127 x 19 mm)	2 x 2 – 2 1/2 x 2 1/2 in. (51 x 51 – 64 x 64 mm)	2 1/8 – 3 3/8 in. (54 – 86 mm)
BBI-6A	7.57 – 12.86 in. (192 – 327 mm)	3 1/2 x 1/2 – 6 x 3/4 in. (89 x 13 – 152 x 19 mm)	2 1/2 x 2 1/2 – 3 x 3 in. (64 x 64 – 76 x 76 mm)	2 1/2 – 4 in. (64 – 102 mm)
BBI-7A	8.28 – 13.00 in. (210 – 330 mm)	4 x 1/4 – 6 x 3/4 in. (102 x 6 – 152 x 19 mm)	2 1/2 x 2 1/2 – 3 x 3 in. (64 x 64 – 76 x 76 mm)	2 3/4 – 4 1/8 in. (70 – 105 mm)
BBI-8A	10.29 – 16.43 in. (261 – 417 mm)	5 x 1/4 – 8 x 3/8 in. (127 x 6 – 203 x 10 mm)	3 x 3 – 4 x 4 in. (76 x 76 – 102 x 102 mm)	3 3/8 – 5 1/8 in. (86 – 130 mm)
BBI-9A	12.29 – 19.23 in. (312 – 488 mm)	6 x 1/4 – 9 x 3/4 in. (152 x 6 – 229 x 19 mm)	3 1/2 x 3 1/2 – 5 x 5 in. (89 x 89 – 127 x 127 mm)	4 – 6 1/8 in. (102 – 156 mm)
BBI-10A	15.43 – 24.14 in. (392 – 613 mm)	8 x 1/4 – 10 x 3/4 in. (203 x 6 – 254 x 19 mm)	5 x 5 – 6 x 6 in. (127 x 127 – 152 x 152 mm)	5 – 7 5/8 in. (127 – 194 mm)
25 kV Bus Bar Size Ranges				
BBI-3A	3.28 – 3.56 in. (83 – 90 mm)	1 1/2 x 1/4 – 1 1/2 x 3/8 in. (38 x 6 – 38 x 10 mm)	MEASURE CIRCUMFERENCE	1 1/8 in. (29 mm)
BBI-4A	5.43 – 5.80 in. (138 – 147 mm)	2 1/2 x 3/8 – 2 1/2 x 5/8 in. (64 x 10 – 64 x 16 mm)	MEASURE CIRCUMFERENCE	1 3/4 in. (44 mm)
BBI-5A	6.67 – 7.18 in. (169 – 182 mm)	3 x 5/8 – 3 x 3/4 in. (76 x 16 – 76 x 19 mm)	MEASURE CIRCUMFERENCE	2 1/8 – 2 1/4 in. (54 – 57 mm)
BBI-6A	7.57 – 8.43 in. (192 – 214 mm)	3 1/2 x 1/2 – 4 x 1/4 in. (89 x 13 – 102 x 6 mm)	MEASURE CIRCUMFERENCE	2 1/2 – 2 5/8 in. (64 – 67 mm)
BBI-7A	8.28 – 10.44 in. (210 – 265 mm)	4 x 1/4 – 5 x 3/8 in. (102 x 6 – 127 x 10 mm)	2 1/2 x 2 1/2 in. (64 x 64 mm)	2 3/4 – 3 1/4 in. (70 – 83 mm)
BBI-8A	10.29 – 12.88 in. (261 – 327 mm)	5 x 1/4 – 6 x 3/4 in. (127 x 6 – 152 x 19 mm)	3 x 3 in. (76 x 76 mm)	3 3/8 – 4 in. (86 – 102 mm)
BBI-9A	12.29 – 15.31 in. (312 – 389 mm)	6 x 1/4 – 7 x 3/4 in. (152 x 6 – 178 x 19 mm)	3 1/2 x 3 1/2 – 4 x 4 in. (89 x 89 – 102 x 102 mm)	4 – 4 7/8 in. (102 – 124 mm)
BBI-10A	15.43 – 19.79 in. (392 – 503 mm)	8 x 1/4 – 9 x 3/4 in. (203 x 6 – 229 x 19 mm)	5 x 5 in. (127 x 127 mm)	5 – 6 1/4 in. (127 – 194 mm)
35 kV Bus Bar Size Ranges				
BBI-7A	8.28 – 8.86 in. (210 – 225 mm)	4 x 1/4 – 4 x 3/4 in. (102 x 6 – 102 x 19 mm)	MEASURE CIRCUMFERENCE	2 3/4 in. (70 mm)
BBI-8A	10.29 – 10.94 in. (261 – 278 mm)	5 x 1/4 – 5 x 3/4 in. (127 x 6 – 127 x 19 mm)	MEASURE CIRCUMFERENCE	3 3/8 in. (86 mm)
BBI-9A	12.29 – 13.00 in. (312 – 330 mm)	6 x 1/4 – 6 x 3/4 in. (152 x 6 – 152 x 19 mm)	MEASURE CIRCUMFERENCE	4 – 4 1/8 in. (102 – 105 mm)
BBI-10A	15.43 – 16.86 in. (392 – 428 mm)	8 x 1/4 – 8 x 3/4 in. (203 x 6 – 203 x 19 mm)	MEASURE CIRCUMFERENCE	5 – 5 1/4 in. (127 – 133 mm)

NOTE:* Rectangular and square bar sizes are based on bars having radiused edges and corners.

NOTE: BBI-A tubing sizing is based on straight sections of bar. For bolted connections consult bolted connection chart on page 3.

NOTE: Contact your 3M sales rep for recommendation on the use of BBI-A on 1/8" thick bus bar.

3M™ Heat Shrinkable Tubing for Bus Bar BBI-A Series 5-35 kV

3M™ Heat Shrinkable Tubing for Bus Bar BBI-A Coverage for Inline Bolted Connections (Rectangular Bus Bar)

Note: First select BBI-A size from preceding charts for Straight Bus Bar

5, 8 & 15kV: Inline Bolted Connections

Rectangular Bar Width	BBI-3A	BBI-4A	BBI-5A	BBI-6A	BBI-7A	BBI-8A	BBI-9A	BBI-10A
1.5 in. (38 mm)	1 Layer							
2.0 in. (51 mm)	2 Layer							
2.5 in. (64 mm)		1 Layer						
3.0 in. (76 mm)		2 Layer						
3.5 in. (102 mm)		2 Layer	1 Layer					
4.0 in. (127 mm)		2 Layer	2 Layer	1 Layer	1 Layer			
5.0 in. 152 mm)			2 Layer	2 Layer	1 Layer	1 Layer		
6.0 in. (178 mm)				2 Layer	2 Layer	1 Layer	1 Layer	
7.0 in. (203 mm)						2 Layer	1 Layer	
8.0 in. (229 mm)						2 Layer	2 Layer	1 Layer
9.0 in. (254 mm)							2 Layer	1 Layer
10.0 in. (254 mm)								2 Layer

25 & 35 kV: Inline Bolted Connections

USE 2 LAYERS OF BBI-A TUBING FOR ALL 25 & 35 kV Inline Bolted Connections

Typical Dimensions

Product Number	Length	Minimum Expanded Tubing I. D.	Expanded Wall Thickness	Max. Recovered Tubing I. D.	Recovered Wall Thickness
BBI-3A	20 & 50 ft (6.1 & 15.2 mm)	2.38 in. (60 mm)	0.049 in. (1,24 mm)	1.01 in. (26 mm)	0.113 in. (2,87 mm)
BBI-4A	20 & 50 ft (6.1 & 15.2 mm)	4.35 in. (110 mm)	0.043 in. (1,09 mm)	1.67 in. (42 mm)	0.113 in. (2,87 mm)
BBI-5A	20 & 50 ft (6.1 & 15.2 mm)	5.30 in. (135 mm)	0.043 in. (1,09 mm)	2.04 in. (52 mm)	0.114 in. (2,90 mm)
BBI-6A	20 & 50 ft (6.1 & 15.2 mm)	5.90 in. (150 mm)	0.046 in. (1,17 mm)	2.33 in. (59 mm)	0.117 in. (2,97 mm)
BBI-7A	20 & 50 ft (6.1 & 15.2 mm)	6.78 in. (172 mm)	0.048 in. (1,22 mm)	2.55 in. (65 mm)	0.130 in. (3,30 mm)
BBI-8A	20 & 50 ft (6.1 & 15.2 mm)	8.25 in. (210mm)	0.049 in. (1,24 mm)	3.18 in. (81 mm)	0.128 in. (3,25 mm)
BBI-9A	20 & 50 ft (6.1 & 15.2 mm)	8.83 in. (224 mm)	0.054 in. (1,37 mm)	3.78 in. (96 mm)	0.127 in. (3,23 mm)
BBI-10A	20 & 50 ft (6.1 & 15.2 mm)	10.28 in. (261 mm)	0.059 in. (1,50 mm)	4.53 in. (115 mm)	0.138 in. (3,51 mm)

3M™ Heat Shrinkable Tubing for Bus Bar BBI-A Series 5-35 kV

Typical Clearances for Rectangular and Square Bus Bars

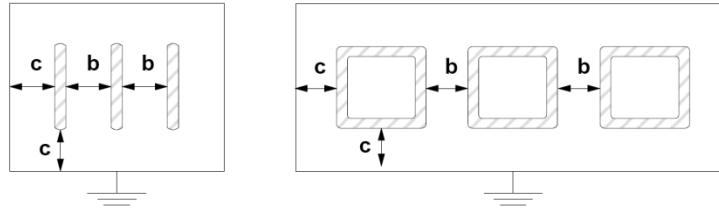

Voltage Rating (kV)	BIL (Kv)	BBI-A Insulated (Indoor Clearance)		Insulated (Indoor Clearance)	
		Dimension b	Dimension c	Dimension b	Dimension c
15 & Below	110	2.7 in. (69 mm)	3.0 in. (76 mm)	7.5 in. (191 mm)	5.0 in. (127 mm)
25	125	3.0 in. (76 mm)	3.5 in. (89 mm)	10.5 in. (267 mm)	7.5 in. (191 mm)
35	150	4.5 in. (114 mm)	5.5 in. (140 mm)	12.5 in. (318 mm)	9.5 in. (241 mm)

NOTE: b = minimum phase-to-phase dimension
c = minimum phase-to-ground dimension

The table indicates typical minimum clearance dimensions for 3M™ Heat Shrinkable Tubing for Bus Bar BBI-A as compared to that for uninsulated bus bar. These dimensions are based on 60 Hz withstand, DC withstand (hypot) and BIL tests (Reference: ANSI/IEEE C37.20) and from partial discharge (corona) tests. Testing was performed on 12 ft. (3,7 m) lengths of copper and aluminum bus bar enclosed in a 3 ft. (0,9 m) long duct, with air spacing between the bar and grounded duct.

Application Tips

1. Keep Torch flame moving to prevent burning.
2. *For rectangular bars:* Shrink the edges of the BBI-A tubing first. This will achieve a more uniform insulation thickness around the bar.
3. BBI-A tubing normally shrinks at approx. 250_F(120_C). (*Caution: burn damage can occur if tubing temperature exceeds approx. 600_F (315_C) for several minutes.*)
4. Dimples appearing in BBI-A tubing during shrinkage are normal, and are removed with continued even heating.
5. Heat application should be discontinued immediately after dimples disappear, or when tubing has shrunk smoothly onto bar.
6. Use proper torch which produces a blue and yellow flame.
7. CAUTION: Be careful handling insulated bus bar while it is still hot. The heated tubing is soft and susceptible to physical damage.
8. SAFETY: Use caution and proper safety procedures when working with open flame and high temperatures. This would include maintaining a well ventilated workplace.

3M™ Heat Shrinkable Tubing for Bus Bar BBI-A Series 5-35 kV

Installation Techniques

An instruction sheet is included in each package to provide the installer with the information required to properly install the 3M™ Heat Shrinkable Tubing on bus bar. A brief summary of the installation for BBI-A is outlined as follows:

Instructions for Straight Bus Bar

1. Clean bus bar and cut BBI-A Tubing to required length. Use a sharp knife or razor to ensure a clean cut with no nicks.
2. Preheating of bus bar is recommended.

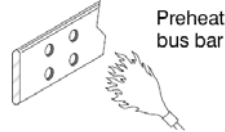

3. Slide BBI-A Tubing into position and shrink onto busbar using standard industry methods.

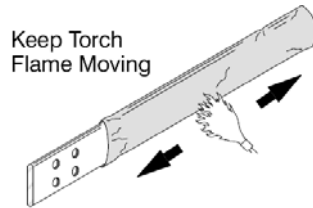

Instructions for Inline Bolted Connections



1. For 15 kV applications consult the Inline Bolted Connections chart on page 3. Determine whether one or two layers of BBI-A will be required. All 25 and 35 kV applications will require two layers of BBI-A (see Additional Instructions for 25 and 35 kV Connections on page 7).
2. Clean the bolted connection.
3. Cut one layer of BBI-A tubing to cover at 6 inches (152 mm) of existing insulation on each side of the connection. Exercise care to ensure a clean cut.
4. Cut a second (outer) layer of BBI-A tubing (if required) to a length that is 2 inches (51 mm) shorter than the first layer.
5. Shrink the first (inner) layer of BBI-A tubing onto the bus bar and bolted connection. If required, center the second layer of tubing over the first layer and shrink using standard industry methods.

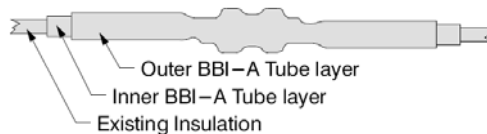

3M™ Heat Shrinkable Tubing for Bus Bar BBI-A Series 5-35 kV

Additional Instruction for 25 and 35 kV Connections

1. Fill in edges of existing bus bar insulation with an electrical grade filler before applying two layers of BBI-A tubing.

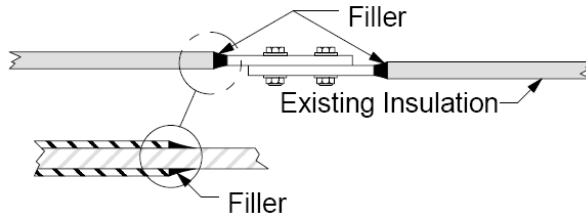

Maintenance

3M™ Heat Shrinkable Tubing for Bus Bar BBI-A is not impaired by freezing or overheating due to ambient temperatures found in storage or shipping. Normal storage and stock rotation practices are recommended.

Shelf Life & Storage

This product has a 10-year shelf life from date of manufacture when stored in a humidity controlled storage (10°C/50°F to 27°C/80°F and <75% relative humidity).

Availability

Please contact your local distributor; available from 3M.com/electrical {Where to Buy} or call 1-800-245-3573.

3M is a trademark of 3M Company.

IMPORTANT NOTICE

All statements, technical information, and recommendations related to 3M's products are based on information believed to be reliable, but the accuracy or completeness is not guaranteed. Before using this product, you must evaluate it and determine if it is suitable for your intended application. You assume all risks and liability associated with such use. Any statements related to the product, which are not contained in 3M's current publications, or any contrary statements contained on your purchase order, shall have no force or effect unless expressly agreed upon, in writing, by an authorized officer of 3M

Warranty; Limited Remedy; Limited Liability

This product will be free from defects in material and manufacture at the time of purchase. **3M MAKES NO OTHER WARRANTIES INCLUDING, BUT NOT LIMITED TO, ANY IMPLIED WARRANTY OF MERCHANTABILITY OR FITNESS FOR A PARTICULAR PURPOSE.** If this product is defective within the warranty period stated above, your exclusive remedy shall be, at 3M's option, to replace or repair the 3M product or refund the purchase price of the 3M product. **Except where prohibited by law, 3M will not be liable for any indirect, special, incidental or consequential loss or damage arising from this 3M product, regardless of the legal theory asserted.**



Electrical Markets Division

6801 River Place Blvd.
Austin, TX 78726-9000
800.245.3573
FAX: 800.245.0329
www.3M.com/electrical

Please recycle
© 3M 2013 All rights reserved
78-8141-4993-2 Rev B

Данный компонент на территории Российской Федерации

Вы можете приобрести в компании MosChip.

Для оперативного оформления запроса Вам необходимо перейти по данной ссылке:

<http://moschip.ru/get-element>

Вы можете разместить у нас заказ для любого Вашего проекта, будь то серийное производство или разработка единичного прибора.

В нашем ассортименте представлены ведущие мировые производители активных и пассивных электронных компонентов.

Нашей специализацией является поставка электронной компонентной базы двойного назначения, продукции таких производителей как XILINX, Intel (ex.ALTERA), Vicor, Microchip, Texas Instruments, Analog Devices, Mini-Circuits, Amphenol, Glenair.

Сотрудничество с глобальными дистрибьюторами электронных компонентов, предоставляет возможность заказывать и получать с международных складов практически любой перечень компонентов в оптимальные для Вас сроки.

На всех этапах разработки и производства наши партнеры могут получить квалифицированную поддержку опытных инженеров.

Система менеджмента качества компании отвечает требованиям в соответствии с ГОСТ Р ИСО 9001, ГОСТ РВ 0015-002 и ЭС РД 009

Офис по работе с юридическими лицами:

105318, г.Москва, ул.Щербаковская д.3, офис 1107, 1118, ДЦ «Щербаковский»

Телефон: +7 495 668-12-70 (многоканальный)

Факс: +7 495 668-12-70 (доб.304)

E-mail: info@moschip.ru

Skype отдела продаж:

moschip.ru

moschip.ru_4

moschip.ru_6

moschip.ru_9