

INTRODUCTIONS

1. Designed as a general purpose filter providing effective EMI suppression.
2. All part numbers are UL recognized, CSA certified and VDE approved.

COMPONENTS

PART NO.	Cx (uF)	L (mH)	Cy (pF)	R (Ω)
02DBAG5	0.1	1.1	3300	-
02DBAW5				
03DBAG5				
03DBAW5				
05DBAG5				
05DBAW5	2.9			
• 05DBDG3	0.22	2.1	-	-
• 05DBDW3				
06DBDW3S	0.47	3.7	330K	
10DBAG5	0.1	1.5	3300	-
10DBAW5				
10DBAS5				
10DBDW3S	0.47	1.45	330K	
10DBDG3S				
* 16DBDG3	1.0	3.6	10000	200K
* 16DBC5	2.2			
20DBAG5	0.33	0.7	3300	-
20DBAS5				
12DBBG5B	0.1	0.7	4700	1.0M
12DBBW5B				
16DBC5B				
16DBCW5B				
20DBC5B				
20DBCS5B				
30DBCS5B	0.47	0.67	10000	

- UL & CSA approved only.
- * No safety approval yet

MINIMUM INSERTION LOSS IN dB

COMMON MODE (L-G) IN 50 OHM SYSTEM						
CURRENT RATING	FREQUENCY-MHz					
	.15	.50	1.0	5.0	10	30
2,3,5A	15	30	38	45	45	40
6A	20	25	35	40	45	35
10A	20	30	35	50	50	45
* 10A	15	22	30	40	40	45
16A(DG3)	20	30	35	45	50	35
* 16A(CG5)	20	30	35	50	50	40
20A	13	20	25	40	45	45
12A (BG5B) (BW5B)	10	20	22	35	40	40
16A (CG5B) (CW5B)	10	18	20	35	50	30
20A (CG5B) (CS5B)	10	20	22	30	35	35
30A (CS5B)	10	28	30	45	50	35
DIFFERENTIAL MODE (L-L) IN 50 OHM SYSTEM						
2,3,5A	6	15	20	40	45	45
6A	10	18	20	30	35	40
10A	6	15	20	44	45	45
* 10A	12	18	20	35	35	40
16A (DG3)	10	30	50	50	50	50
* 16A (CG5)	20	30	40	45	40	30
20A	15	24	28	45	45	45
12A (BG5B) (BW5B)	5	12	15	35	45	35
16A (CG5B) (CW5B)	5	10	15	45	45	40
20A (CG5B) (CS5B)	4	10	15	45	45	40
30A (CS5B)	12	20	25	45	50	45

* 10DBDG3S, DW3S

SPECIFICATIONS

1. Maximum leakage current each
 - line-to-ground @ 115VAC 60Hz: 0.25mA
 - 1.0mA (10000pF)
 - @ 250VAC 50Hz: 0.45mA
 - 2.0mA (10000pF)
2. Hipot rating (one minute)
 - line-to-ground: 2250VDC
 - line-to-line: 1450VDC
3. Operating frequency: 50/60Hz
4. Rated voltage: 115/250VAC

SERIES DIMENSIONS

CURRENT RATING	STYLE	DIMENSIONS IN INCHES/mm				
		A	B	C	D	E
2A	AG5	2.15	16.5	0.65	-	2.54
		54.6				
	0.96					
3A	AG5	24.4	1.77	0.77	2.13	64.5
		2.54				
	64.5					
5A	AG5	1.33	45.0	19.5	54.1	63.5
		33.8				
	33.8					
6A	DW3S	2.55	2.08	1.29	1.575	0.61
		64.77	52.83	32.77	40.01	15.49
10A	AG5	2.54	1.77	1.18	2.13	2.50
		64.5				
		1.33				
	AW5	33.8	45.0	30.0	54.1	64.8
		3.10				
		78.7				
AS5	2.02	2.18	2.38	2.77	2.77	
	51.3	30.0	60.5	70.3	70.3	
	2.55	2.08	1.29	1.575	0.61	
16A	DG3S	64.80	52.80	32.80	40.00	15.50
		3.14	2.10	1.28	1.575	0.61
	DG3	79.80	53.30	32.50	40.00	15.50
20A	AG5	4.35	1.34	1.65	2.24	0.63
		110.50	34.0	42.0	57.0	16.0
	CG5	3.75	2.06	1.54	2.94	3.34
AS5	AG5	95.25	52.30	39.10	74.70	84.80
		3.25	2.02	1.16	2.38	2.75
	AS5	82.5	51.3	29.5	60.5	69.9
AS5	AS5	3.37	2.02	1.15	2.38	2.77

CURRENT RATING	STYLE	DIMENSIONS IN INCHES/mm					
		A	B	C	D	E	F
12A	BG5B	2.13	2.54	1.34	1.77	-	-
	BW5B	54.00	64.5	34.0	45.0		
16A	CG5B	2.40	2.81	1.79	2.02	1.18	-
	CW5B	61.00	71.5	45.5	51.3		
20A	CG5B	2.95	3.34	2.04	2.52	-	-
	CS5B	75.00	84.8	51.8	64.0		
30A	CS5B	4.06	4.49	2.22	3.74	1.83	-
		103.0	114.0	56.5	95.0	46.4	

ELECTRICAL SCHEMATIC

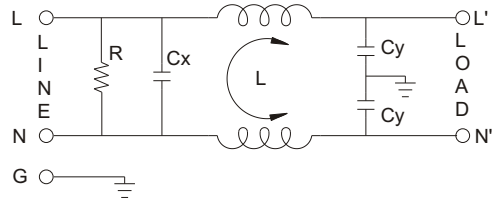
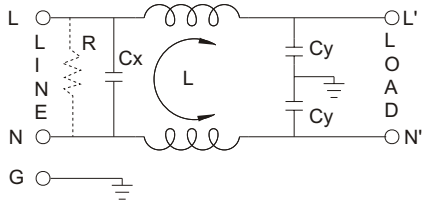

XXDBXX5B

INSERTION LOSS (TYPICAL)

02DBAG5----- COMMON MODE ----- DIFF. MODE
03DBAG5----- COMMON MODE ----- DIFF. MODE

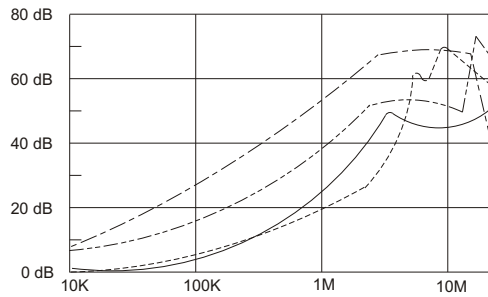

05DBAG5----- COMMON MODE ----- DIFF. MODE
10DBAG5----- COMMON MODE ----- DIFF. MODE

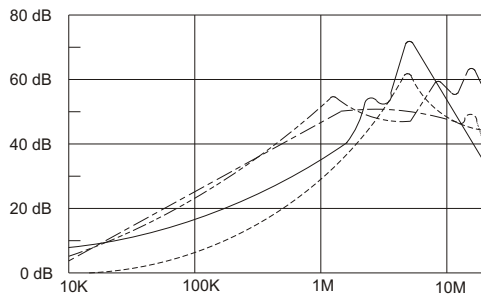

20DBAG5----- COMMON MODE ----- DIFF. MODE

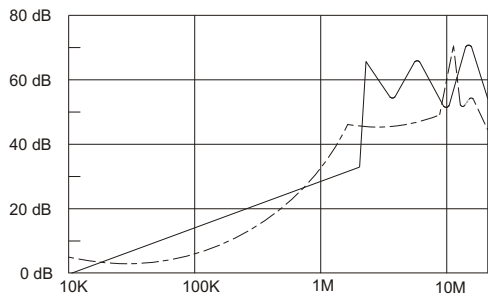

20DBC5B ----- COMMON MODE ----- DIFF. MODE
20BCS5B ----- COMMON MODE ----- DIFF. MODE
30BCS5B ----- COMMON MODE ----- DIFF. MODE

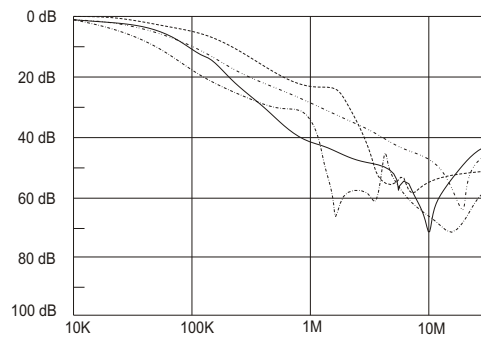

12DBBG5B ----- COMMON MODE ----- DIFF. MODE
12DBBW5B ----- COMMON MODE ----- DIFF. MODE

16DBC5B ----- COMMON MODE ----- DIFF. MODE
16DBCW5B ----- COMMON MODE ----- DIFF. MODE

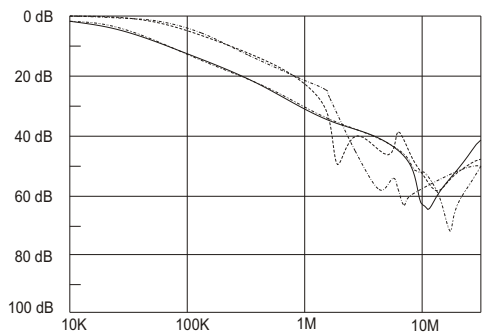

MECHANICAL CONSTRUCTION

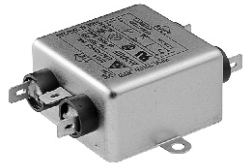

AG5

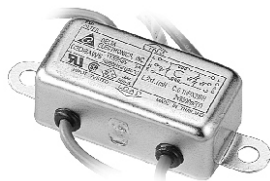
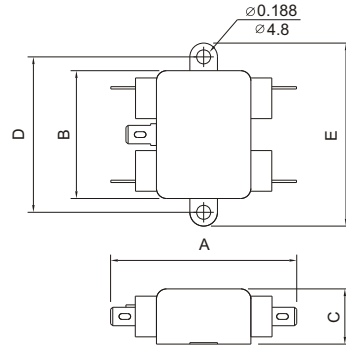

AW5

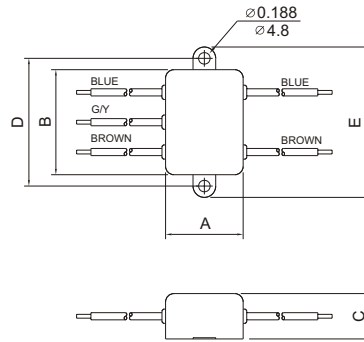

CG5

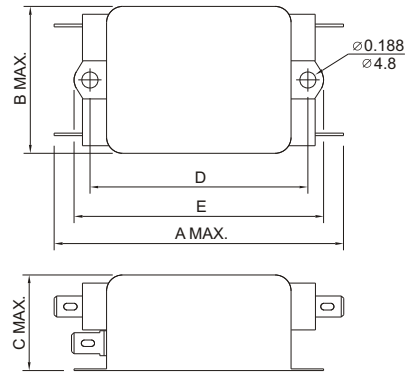

DW3S

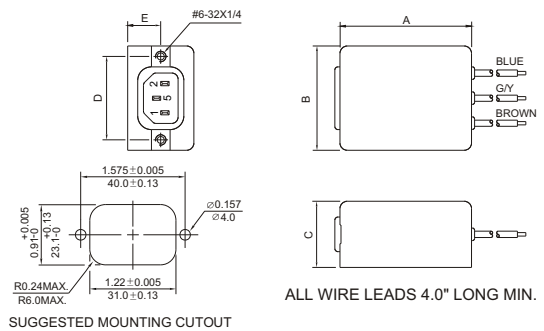

UNIT: INCH
mm

MECHANICAL CONSTRUCTION

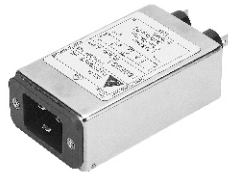

DG3

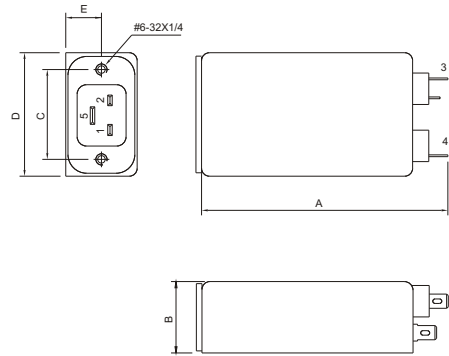

DG3S

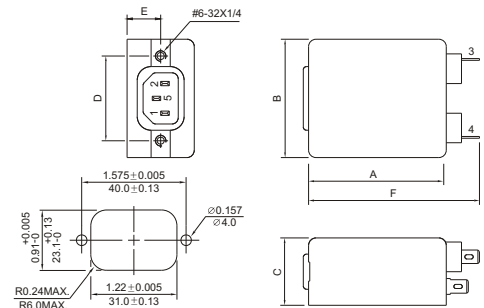

SUGGESTED MOUNTING CUTOUT



AS5

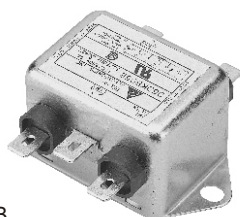
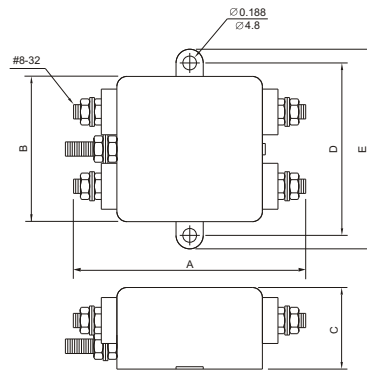

BG5B, BW5B
(option wire style)

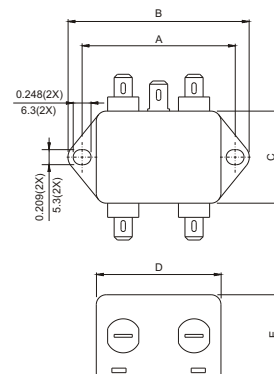

MECHANICAL CONSTRUCTION

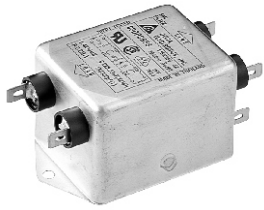

CG5B

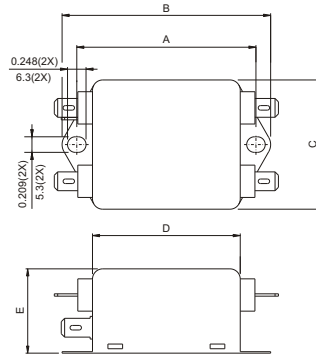

CW5B

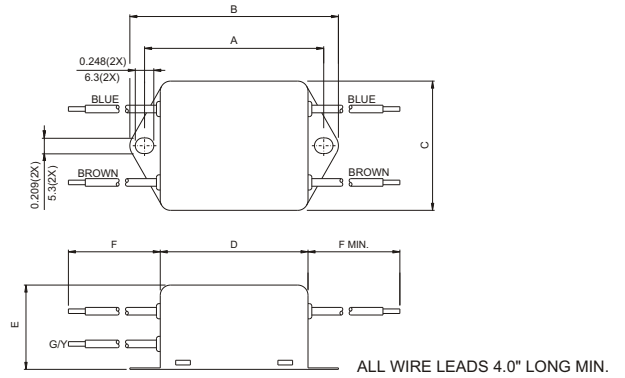

CS5B

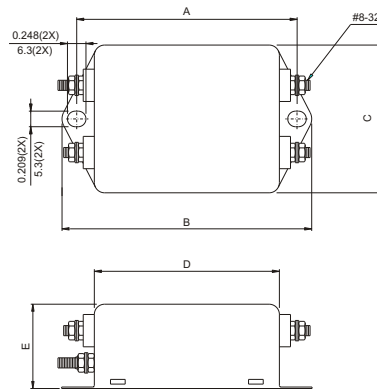

UNIT: $\frac{\text{INCH}}{\text{mm}}$

Данный компонент на территории Российской Федерации

Вы можете приобрести в компании MosChip.

Для оперативного оформления запроса Вам необходимо перейти по данной ссылке:

<http://moschip.ru/get-element>

Вы можете разместить у нас заказ для любого Вашего проекта, будь то серийное производство или разработка единичного прибора.

В нашем ассортименте представлены ведущие мировые производители активных и пассивных электронных компонентов.

Нашей специализацией является поставка электронной компонентной базы двойного назначения, продукции таких производителей как XILINX, Intel (ex.ALTERA), Vicor, Microchip, Texas Instruments, Analog Devices, Mini-Circuits, Amphenol, Glenair.

Сотрудничество с глобальными дистрибьюторами электронных компонентов, предоставляет возможность заказывать и получать с международных складов практически любой перечень компонентов в оптимальные для Вас сроки.

На всех этапах разработки и производства наши партнеры могут получить квалифицированную поддержку опытных инженеров.

Система менеджмента качества компании отвечает требованиям в соответствии с ГОСТ Р ИСО 9001, ГОСТ РВ 0015-002 и ЭС РД 009

Офис по работе с юридическими лицами:

105318, г.Москва, ул.Щербаковская д.3, офис 1107, 1118, ДЦ «Щербаковский»

Телефон: +7 495 668-12-70 (многоканальный)

Факс: +7 495 668-12-70 (доб.304)

E-mail: info@moschip.ru

Skype отдела продаж:

moschip.ru

moschip.ru_4

moschip.ru_6

moschip.ru_9