

RFSW6042

Low Insertion High Isolation SP4T Switch
5MHz to 6000MHz

The RFSW6042 is a low loss, high isolation SP4T switch with performance optimized for use in Cellular BTS applications. Plus it is also ideally suited for use in CATV and SATV applications. This part is packaged in a compact 1.8mm x 1.8mm, 12-pin, QFN package which allows for a small solution size with no need for external DC blocking capacitors (when no external DC is applied to the device ports).



Package: QFN, 12-pin,
1.8mm x 1.8mm

Features

- 5MHz to 6000MHz Operation
- Low Insertion Loss: 0.45dB at 2GHz
- High Isolation: 34dB at 2GHz
- High IP3: >70dBm at 2GHz
- Compatible with Low Voltage Logic (V_{HIGH} Minimum = 1.3V)
- No External DC Blocking
 - Capacitors Required on RF Paths if DC is Applied Externally
- 2000V HBM ESD Rating on All Ports
- 3V to 5V Operation

Applications

- Cellular BTS
- CATV, SATV Applications
- Test Equipment
- General Purpose Switch

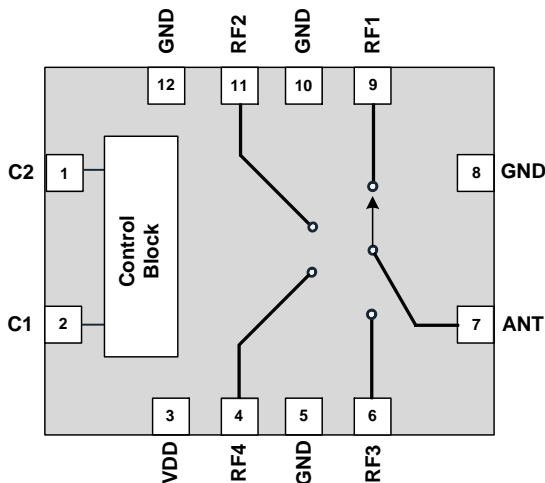

Functional Block Diagram

Ordering Information

RFSW6042SQ	Sample bag with 25 pieces
RFSW6042SR	7" Reel with 100 pieces
RFSW6042TR7	7" Reel with 2500 pieces
RFSW6042PCK-410	5MHz to 3GHz PCBA with 5-piece sample bag
RFSW6042PCK-411	3GHz to 6GHz PCB with 5-piece sample bag

Absolute Maximum Ratings

Parameter	Rating	Unit
Control Voltage (V_{CTL})	3.0	V
Supply Voltage (V_{DD})	6.0	V
Maximum CW Input Power for $V_{DD} = 3V$	35	dBm
Storage Temperature Range	-40 to +150	°C
ESD Rating - Human Body Model (HBM)	2000	V
Moisture Sensitivity Level	MSL2	



Caution! ESD sensitive device.



RFMD Green: RoHS status based on EU Directive 2011/65/EU (at time of this document revision), halogen free per IEC 61249-2-21, < 1000ppm each of antimony trioxide in polymeric materials and red phosphorus as a flame retardant, and <2% antimony in solder.

Exceeding any one or a combination of the Absolute Maximum Rating conditions may cause permanent damage to the device. Extended application of Absolute Maximum Rating conditions to the device may reduce device reliability. Specified typical performance or functional operation of the device under Absolute Maximum Rating conditions is not implied.

Recommended Operating Condition

Parameter	Specification			Unit
	Min	Typ	Max	
Operating Temperature Range	-40		+85	°C
V_{DD} – Switch Supply Voltage	3	5	5.5	V

Nominal Operating Parameters

Parameter	Specification			Unit	Condition
	Min	Typ	Max		
General Performance					Electrical Specifications, $T_A=25^\circ\text{C}$, $V_{DD}=5V$
Operating Frequency Range	5		6000	MHz	
Insertion Loss (RFC to RF1/RF2/RF3/RF4)		0.32	0.5	dB	925MHz
		0.45	0.6	dB	1990MHz
		0.45		dB	2650MHz
		1.25		dB	5850MHz
Isolation (RFC to RF1/RF2/RF3 / RF4)		36		dB	925MHz
		28		dB	1990MHz
		25		dB	2650MHz
		17		dB	5850MHz
Isolation (RF1 to RF2/RF3/RF4)	35	43		dB	925MHz
	27	34		dB	1990MHz
		30		dB	2650MHz
		15		dB	5850MHz
Return Loss (On State)		-15		dB	5MHz ~ 3GHz
Return Loss (On State)		-12		dB	3GHz ~ 6GHz
900MHz Second Harmonic		-108	-95	dBc	$P_{in} = 28\text{dBm}$

Parameter	Specification			Unit	Condition
	Min	Typ	Max		
900MHz Third Harmonic		-103	-90	dBc	
2000MHz Second Harmonic		-100	-80	dBc	Pin = 33dBm
2000MHz Third Harmonic		-89	-77	dBc	
Input IP3		71		dBm	2Ghz, 21dBm per tone, 1MHz spacing
Max Operational Input Power		35		dBm	
Power Supply					
V _{DD} Supply Current		65	130	μA	
CTL1, CTL2 – Control Voltage High	1.3		2.7	V	
CTL1, CTL2 – Control Voltage Low	0		0.45	V	
Control Current			5	μA	
Switching Speed, One RF Port to Another		2	5	us	10% to 90% RF
Turn On Time			20	us	Time for V _{DD} = 0V to part ON and RF = 90%

Power-up / Power-down Sequence and Operation Controls

Power-up / Power-down	Sequence for Power-up and Power-down from Supply that is Connected to V _{DD} Pin
Power-up	Turn on V _{DD} , then C1 and C2, then (20μs or greater), apply RF signal
Power-down	Turn off RF signal, then C1 and C2, turn off V _{DD}
Switching Ports	Turn off RF signal, then change C1 and C2 state, then (5μs or greater). Turn on RF signal

Switch is controlled by C1 and C2

Mode	C1	C2
RF1-ANT	High	Low
RF2-ANT	Low	High
RF3-ANT	High	High
RF4-ANT	Low	Low

Typical Performance: 5MHz ~ 3000MHz, V_{DD} = 5V unless otherwise noted

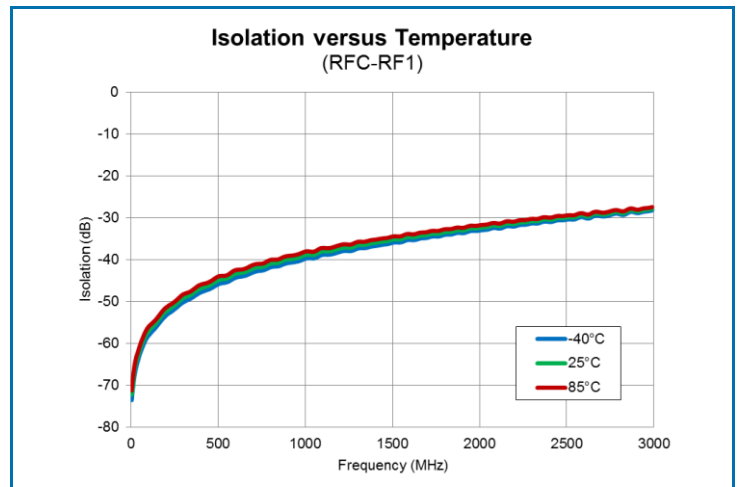
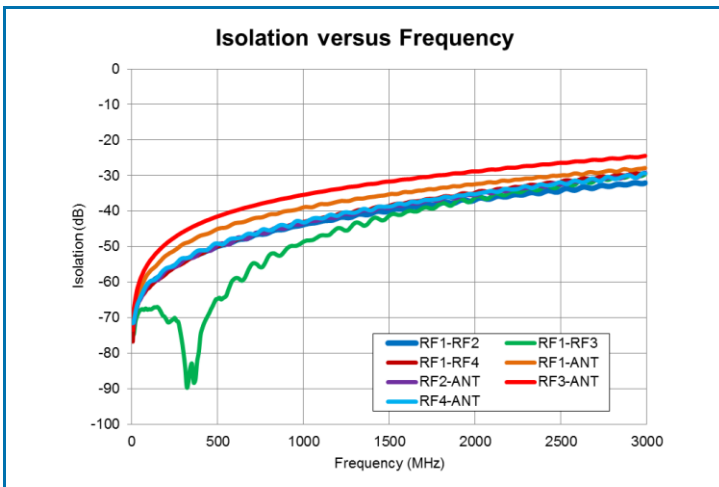
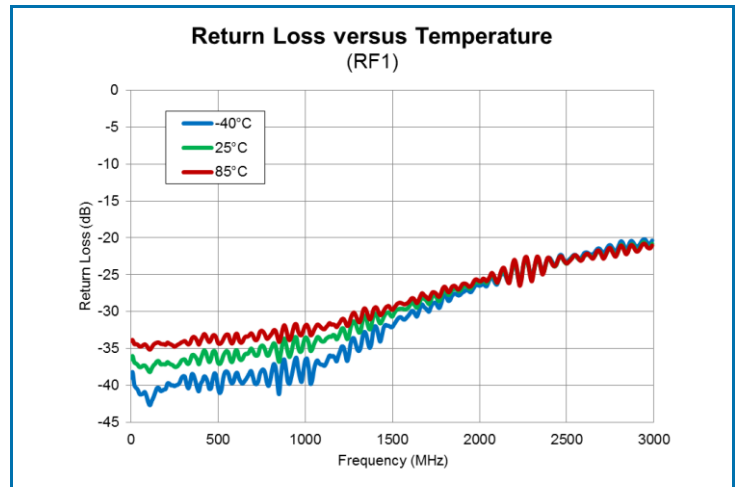
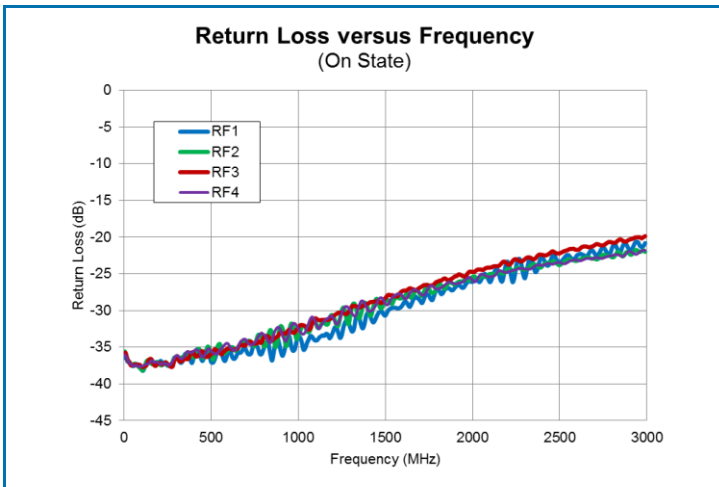
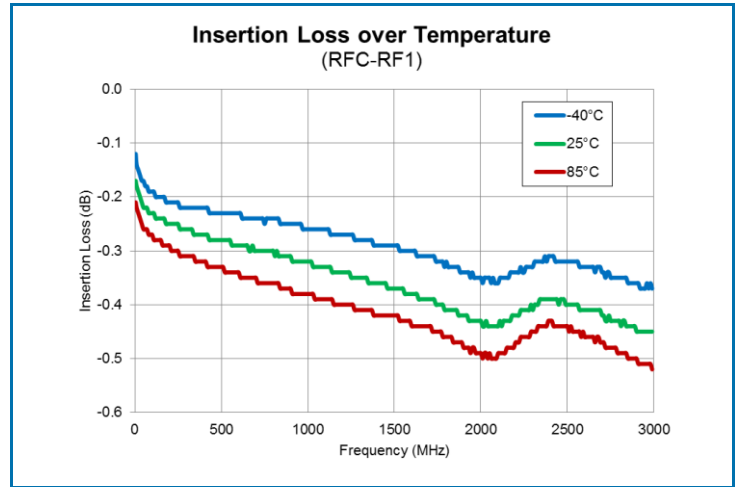
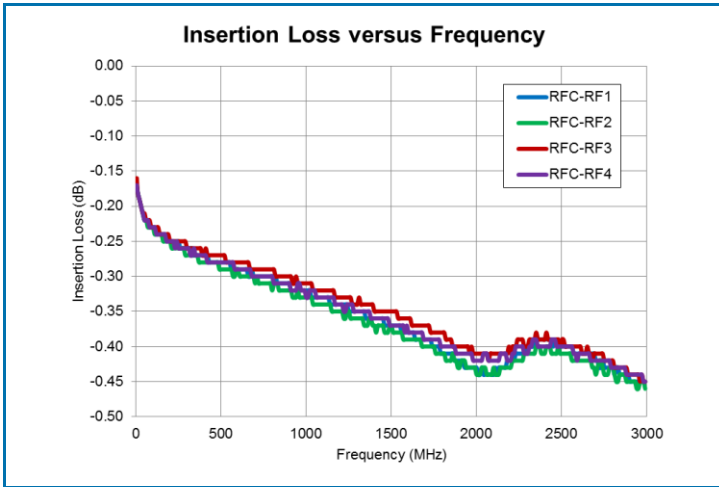

Typical Performance: 5MHz ~ 3000MHz, $V_{DD} = 5V$ unless otherwise noted

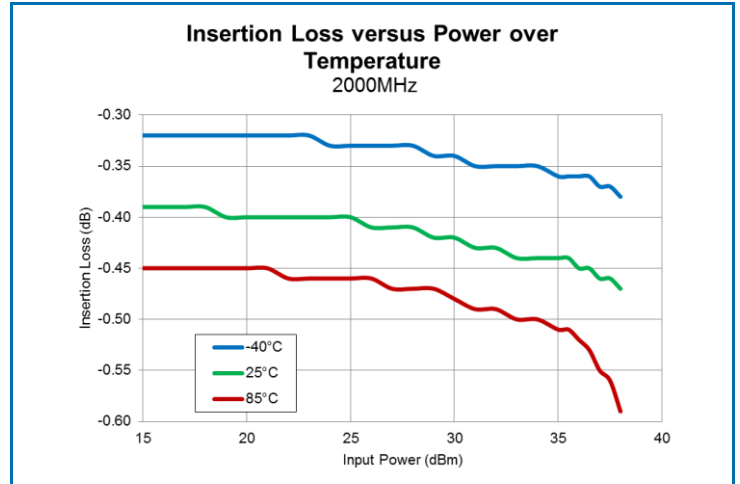
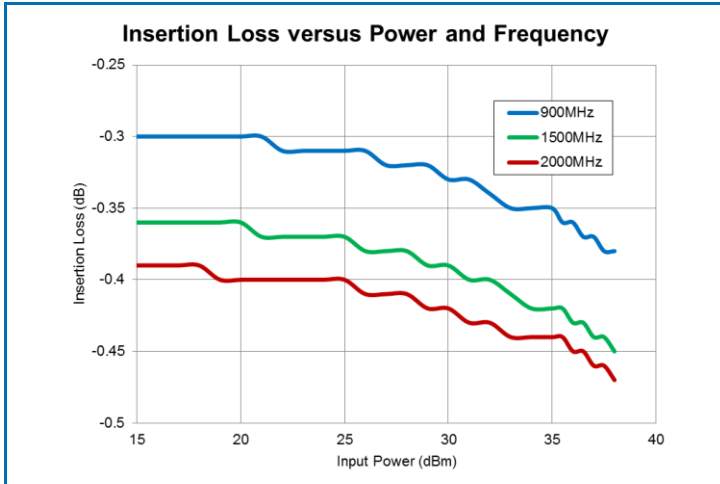

Evaluation Board Schematic 5MHz to 3000MHz Application Circuit

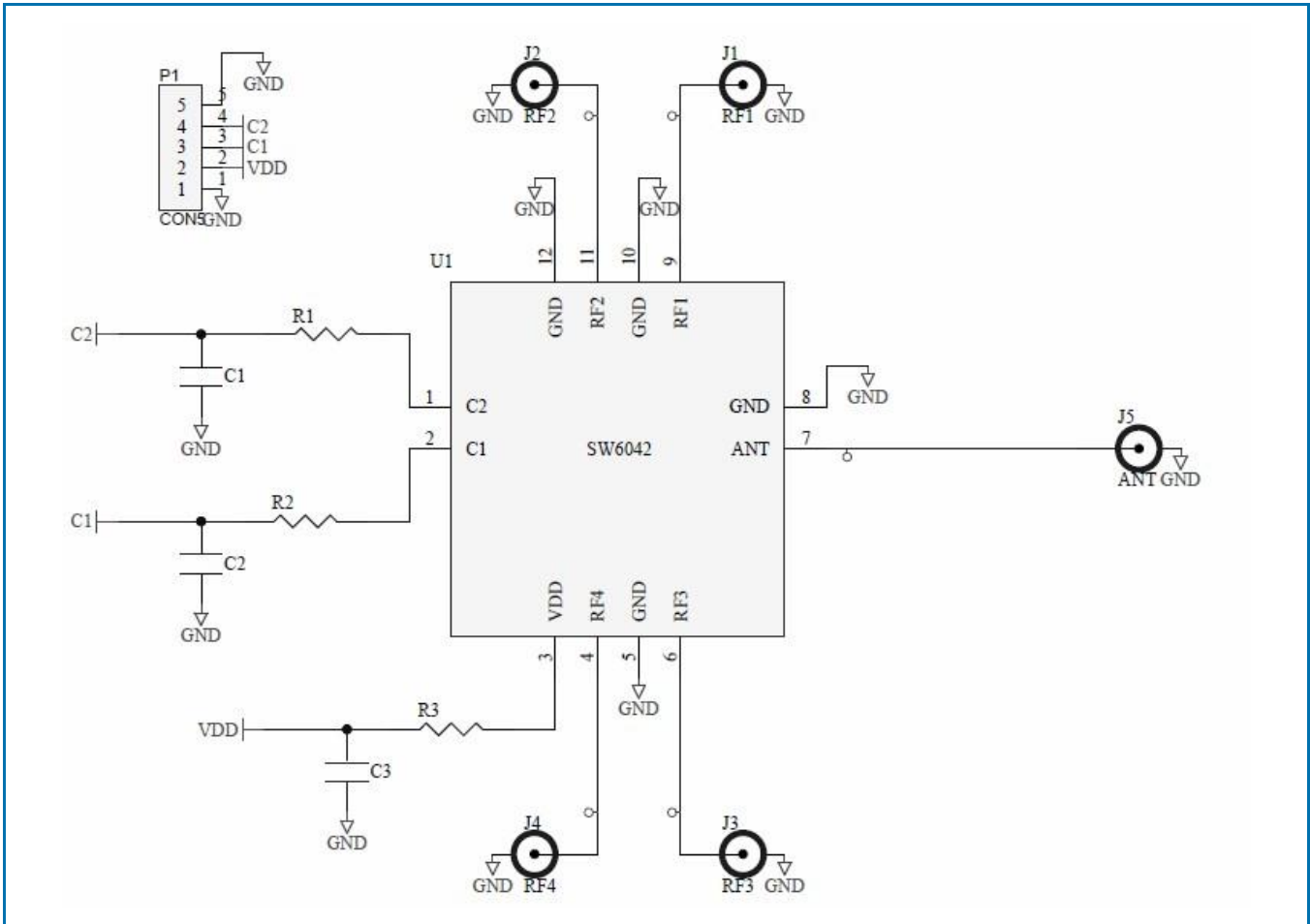

Evaluation Board Bill of Materials (BOM) 5MHz to 3000MHz Application Circuit

Description	Reference Designator	Manufacturer	Manufacturer's P/N
RFSW6032 Evaluation Board			RFSW6032-410
CAP, 100pF, 5%, 50V, C0G, 0402	C1-C2	Murata Electronics	GRM1555C1H101JA01D
CAP, 10000pF, 10%, 25V, X7R, 0402	C3	Murata Electronics	GRM155R71E103KA01D
RES, 0Ω, 0402	R1-R3	Kamaya, Inc.	RMC1-16SJPTH
CONN, SMA, END LNCH, MINI, FLT, 0.068"	J1-J5	Emerson Network Power	142-0741-851
CONN, HDR, ST, PLRZD, 5-PIN, 0.100"	P1	ITW Pancon	MPSS100-5-C
High Power SP4T	U1	RFMD	RFSW6042

Typical Performance: 3000MHz ~ 6000MHz, $V_{DD} = 5V$ unless otherwise noted

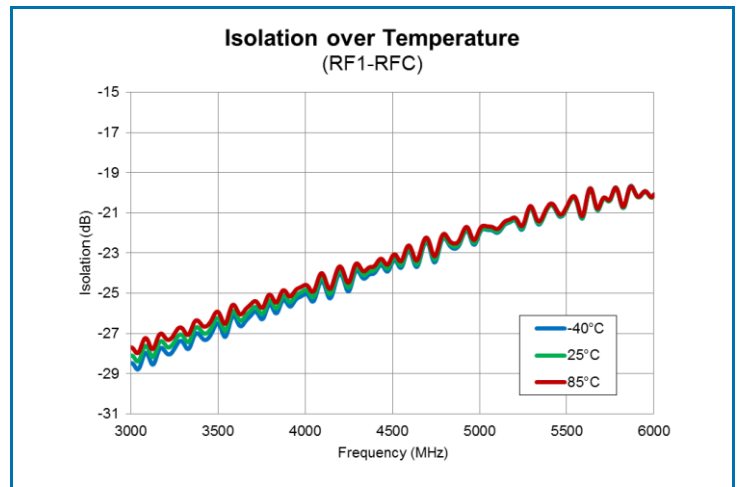
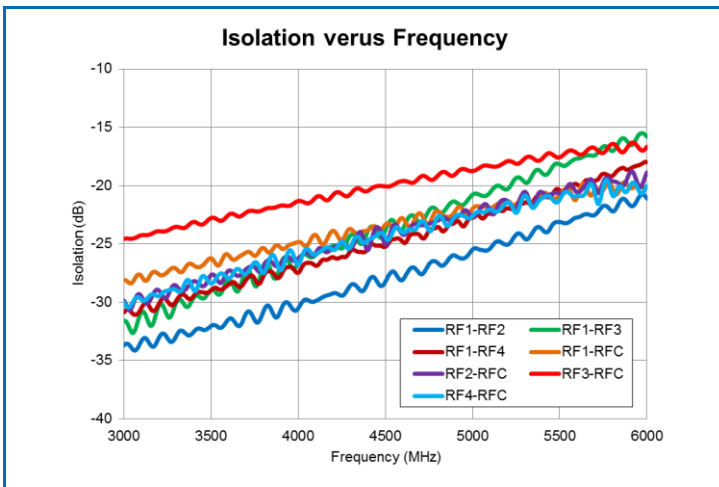
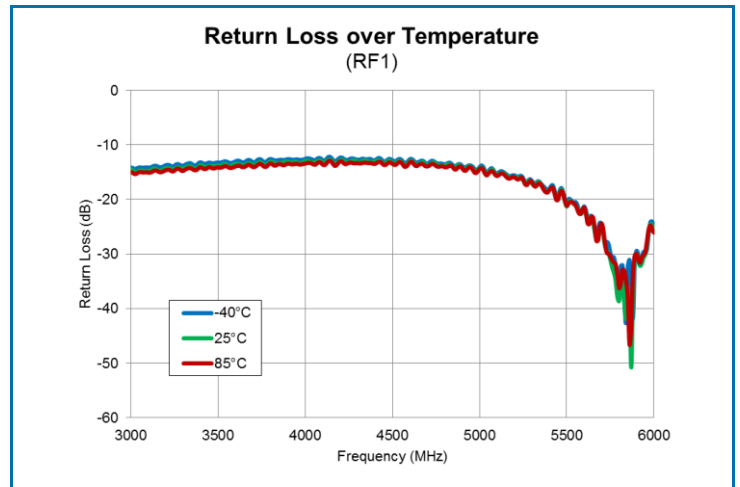
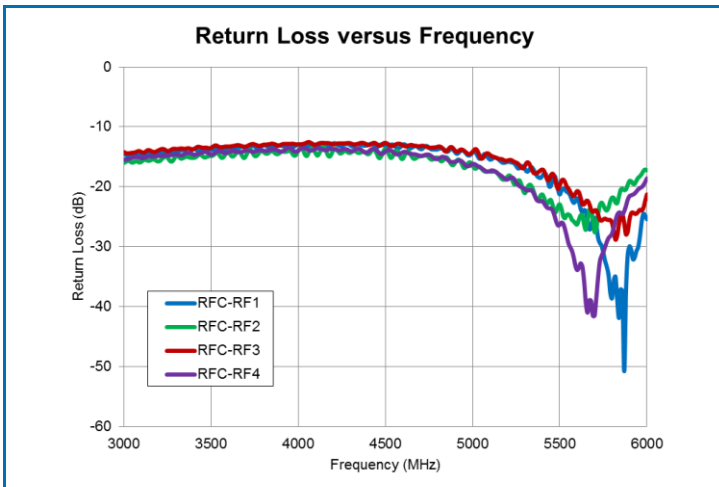
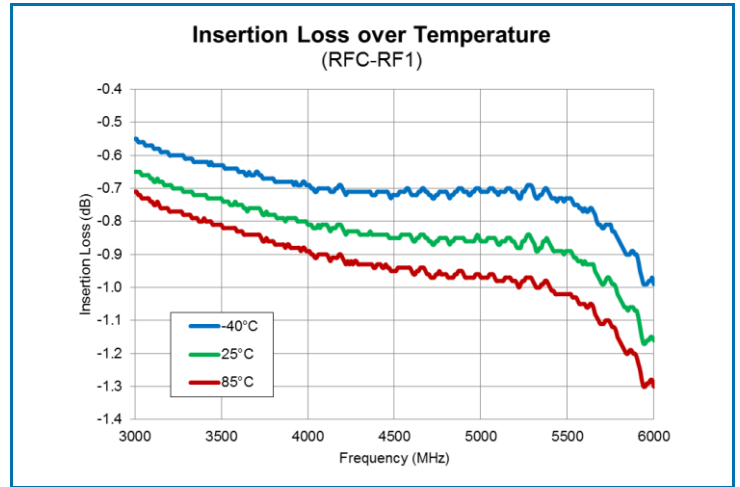
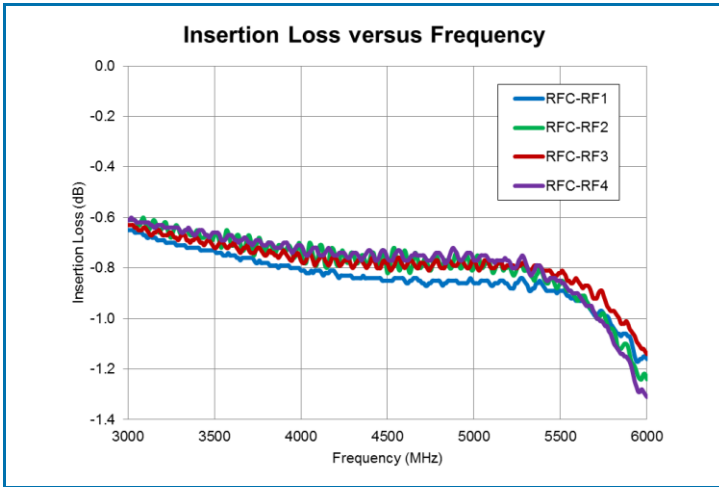

Typical Performance: 3000MHz ~ 6000MHz, $V_{DD} = 5V$ unless otherwise noted

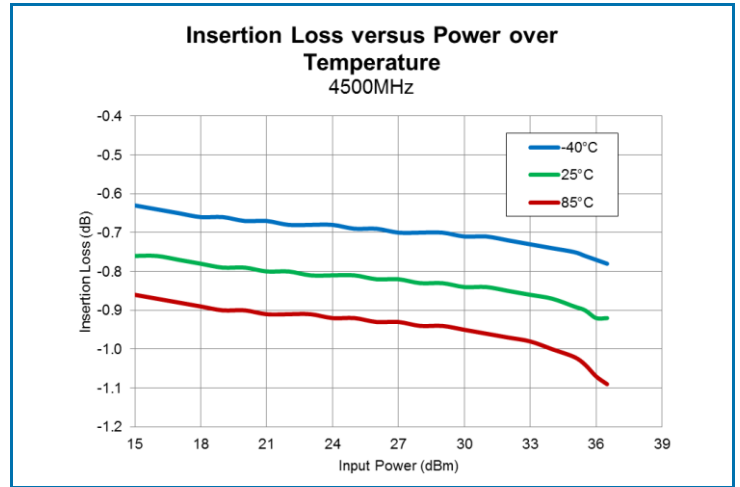
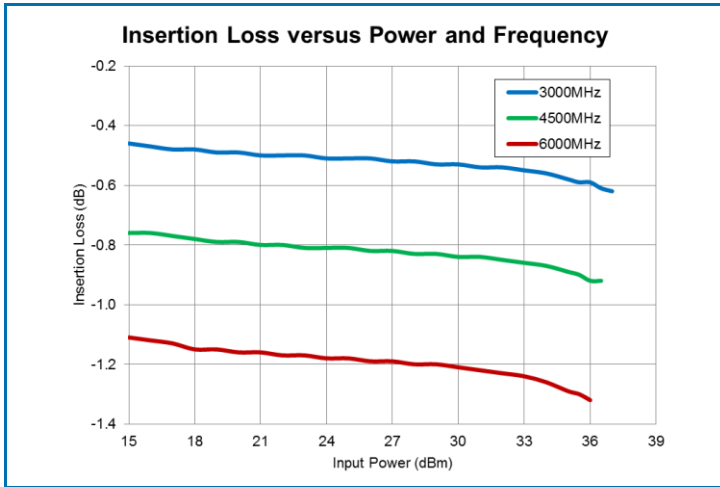

Evaluation Board Schematic 3000MHz to 6000MHz Application Circuit

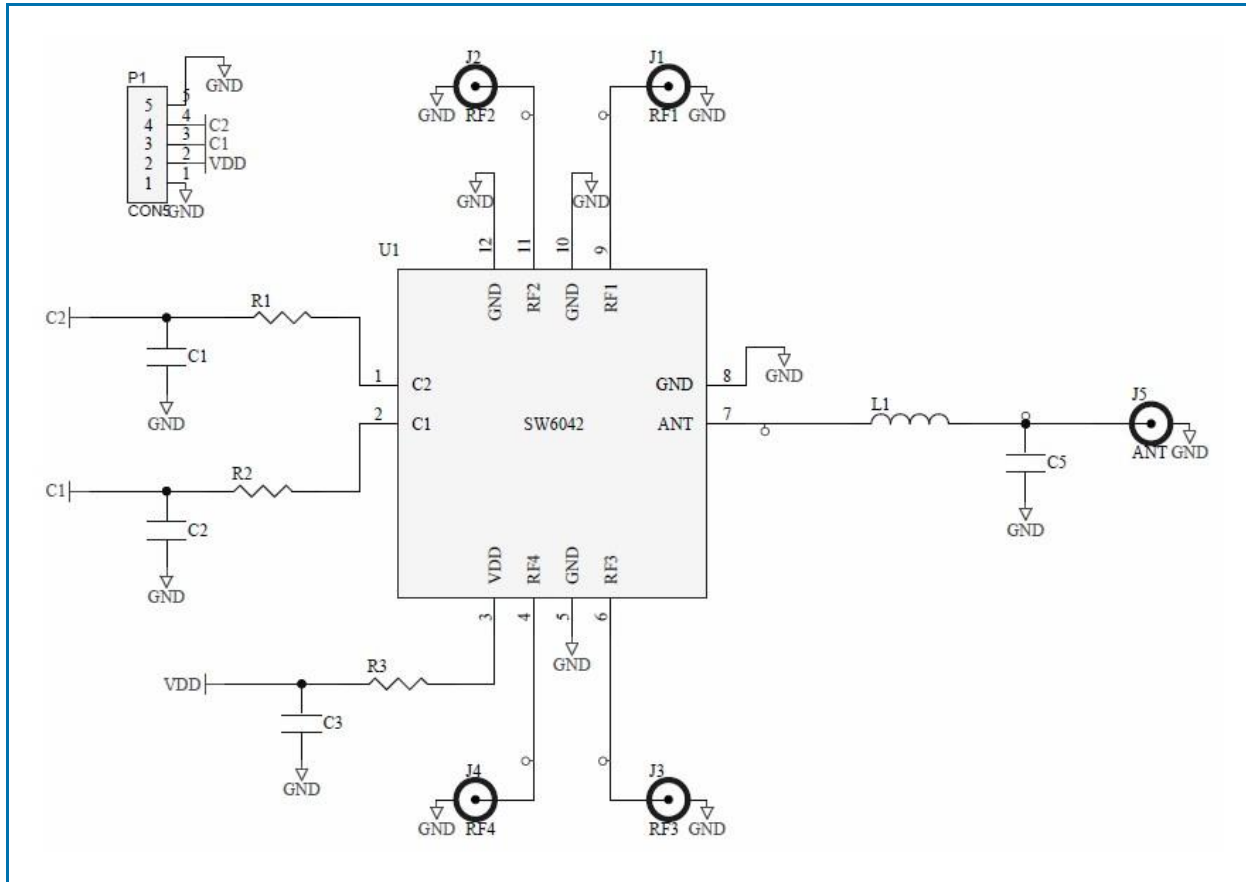

Evaluation Board Bill of Materials (BOM) 3000MHz to 6000MHz Application Circuit

Description	Reference Designator	Manufacturer	Manufacturer's P/N
RFSW6032 Evaluation Board			RFSW6032-410
CAP, 100pF, 5%, 50V, C0G, 0402	C1-C2	Murata Electronics	GRM1555C1H101JA01D
CAP, 10000pF, 10%, 25V, X7R, 0402	C3	Murata Electronics	GRM155R71E103KA01D
CAP, 0.5pF, +/-0.25pF, 50V, C0G, 0402	C5	Murata Electronics	GRM1555C1HR50CA01D
RES, 0Ω, 0402	R1-R3	Kamaya, Inc.	RMC1-16SJPTH
IND, 1nH, +/-0.1nH, T/F, 0201	L1	Murata Electronics	LQP03TG1N0B02D
CONN, SMA, END LNCH, MINI, FLT, 0.068"	J1-J5	Emerson Network Power	142-0741-851
CONN, HDR, ST, PLRZD, 5-PIN, 0.100"	P1	ITW Pancon	MPSS100-5-C
High Power SP4T	U1	RFMD	RFSW6042

Evaluation Board Assembly Drawing

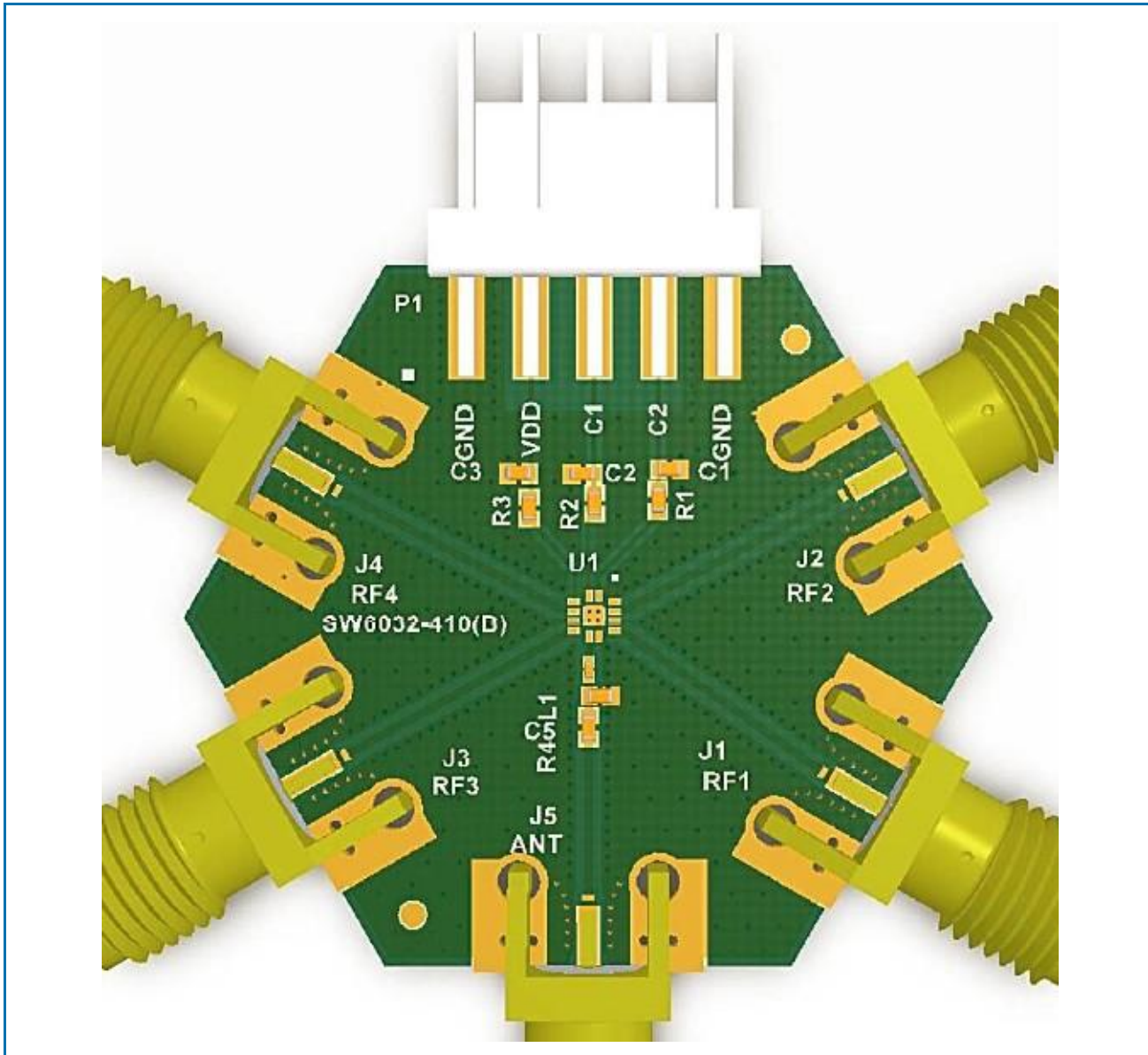

Pin Names and Descriptions

Pin	Name	Description
1	C2	Switch Logic Control 2
2	C1	Switch Logic Control 1
3	VDD	Supply Voltage
4	RF4	Single-ended RF Port
5	GND	Low Inductance Path to Ground
6	RF3	Single-ended RF Port
7	ANT	Single-ended RF Port
8	GND	Low Inductance Path to Ground
9	RF1	Single-ended RF Port
10	GND	Low Inductance Path to Ground
11	RF2	Single-ended RF Port
12	GND	Low Inductance Path to Ground

Package Outline Drawing (Dimensions in millimeters)

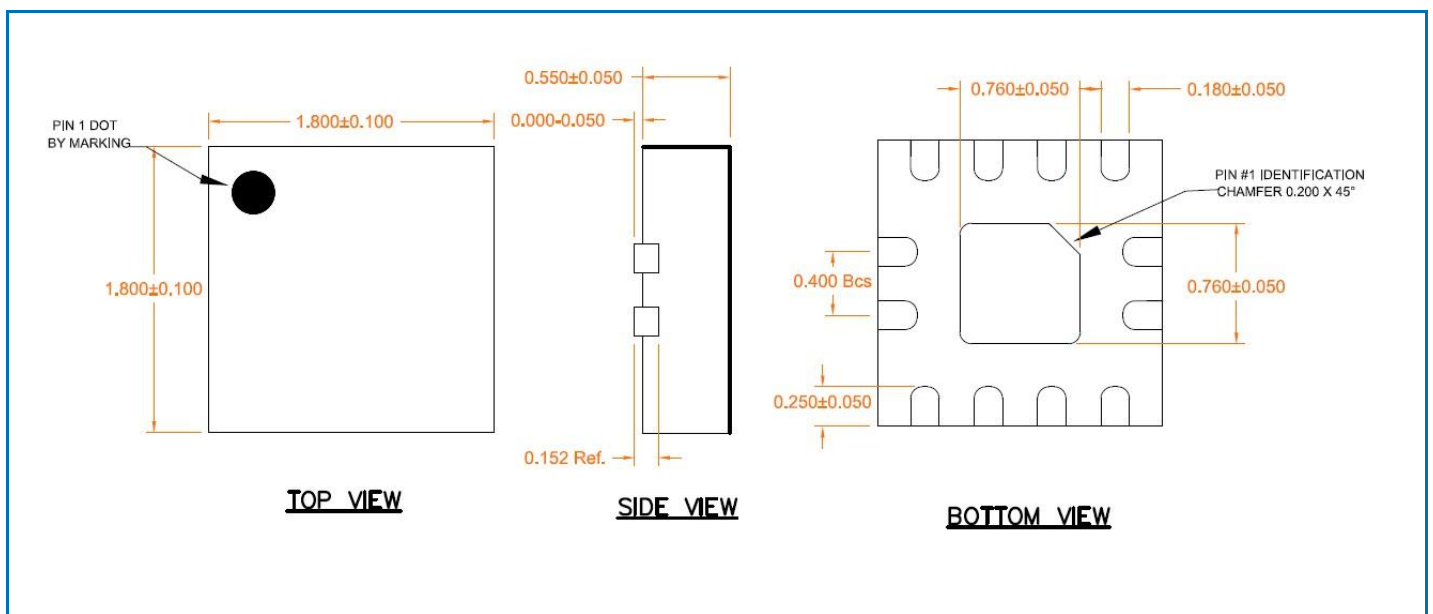

Stencil, PCB Pattern (Dimensions in millimeters)

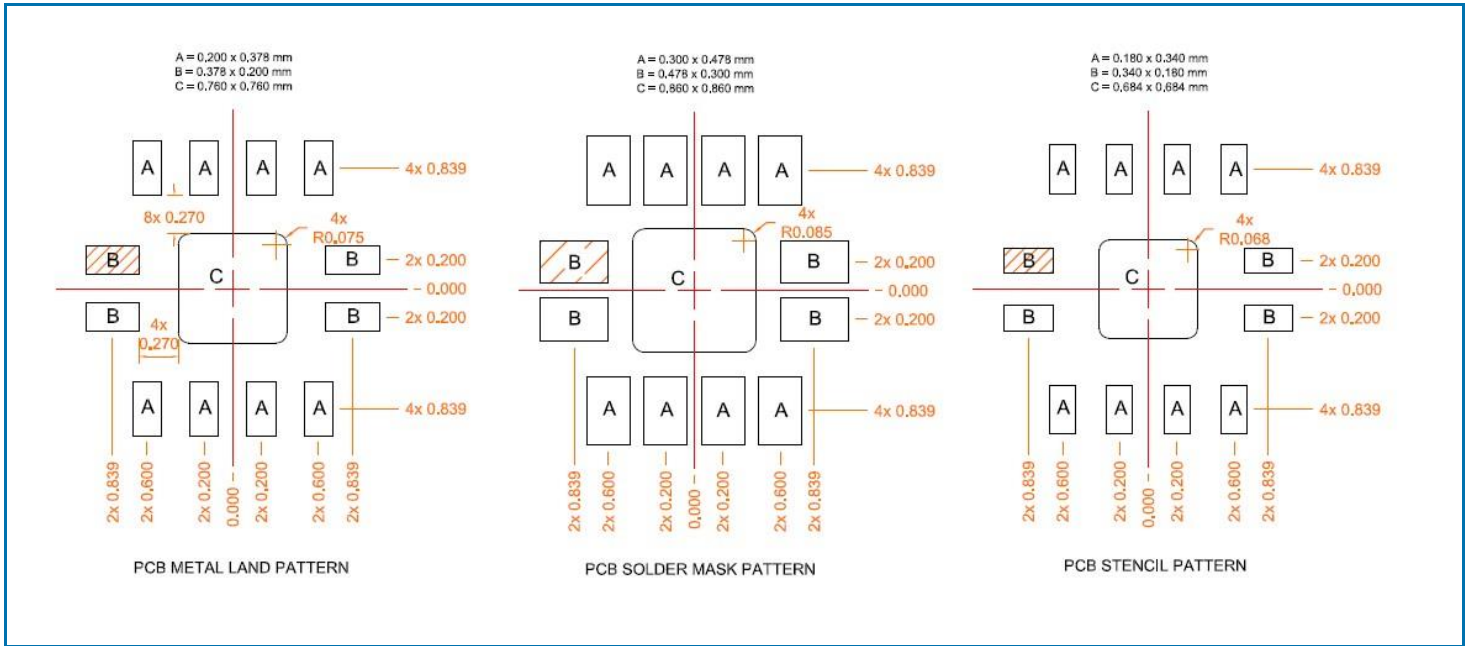

Branding Diagram

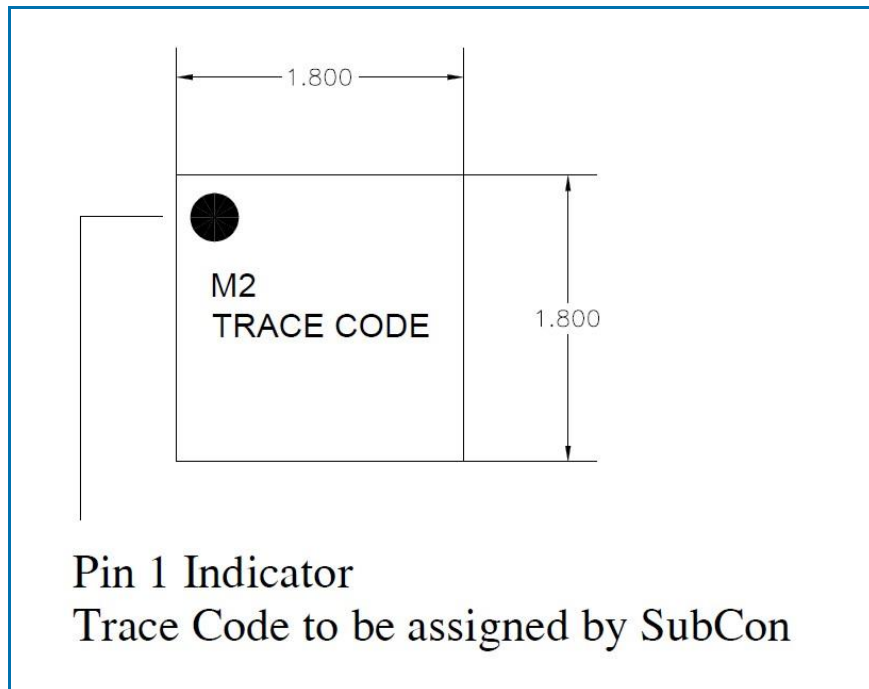

Данный компонент на территории Российской Федерации

Вы можете приобрести в компании MosChip.

Для оперативного оформления запроса Вам необходимо перейти по данной ссылке:

<http://moschip.ru/get-element>

Вы можете разместить у нас заказ для любого Вашего проекта, будь то серийное производство или разработка единичного прибора.

В нашем ассортименте представлены ведущие мировые производители активных и пассивных электронных компонентов.

Нашей специализацией является поставка электронной компонентной базы двойного назначения, продукции таких производителей как XILINX, Intel (ex.ALTERA), Vicor, Microchip, Texas Instruments, Analog Devices, Mini-Circuits, Amphenol, Glenair.

Сотрудничество с глобальными дистрибьюторами электронных компонентов, предоставляет возможность заказывать и получать с международных складов практически любой перечень компонентов в оптимальные для Вас сроки.

На всех этапах разработки и производства наши партнеры могут получить квалифицированную поддержку опытных инженеров.

Система менеджмента качества компании отвечает требованиям в соответствии с ГОСТ Р ИСО 9001, ГОСТ РВ 0015-002 и ЭС РД 009

Офис по работе с юридическими лицами:

105318, г.Москва, ул.Щербаковская д.3, офис 1107, 1118, ДЦ «Щербаковский»

Телефон: +7 495 668-12-70 (многоканальный)

Факс: +7 495 668-12-70 (доб.304)

E-mail: info@moschip.ru

Skype отдела продаж:

moschip.ru

moschip.ru_4

moschip.ru_6

moschip.ru_9